



737-6Q8/-7Q8/-8Q8

Flight Crew
Operations Manual

MALEV Hungarian Airlines
(Magyar Legikozlekedesi Vallalat)

Copyright © 2002
The Boeing Company
All Rights Reserved

Document Number D6-27370-7Q8-HGA
September 30, 2002

Revision Number: 6
Revision Date: September 29, 2005



Copyright Information

Boeing claims copyright in each page of this document only to the extent that the page contains copyrightable subject matter. Boeing also claims copyright in this document as a compilation and/or collective work.

The right to reproduce, distribute, display, and make derivative works from this document, or any portion thereof, requires a license from Boeing. For more information, contact The Boeing Company, P.O. Box 3707, Seattle, Washington 98124.

Boeing 707, 717, 727, 737, 747, 757, 767, 777, DC-8, DC-9, DC-10, MD-10, MD-11, MD-80, MD-90, BBJ, Boeing Business Jet, the Boeing logo symbol, and the red-white-and-blue Boeing livery are all trademarks owned by The Boeing Company; and no trademark license (either expressed or implied) is granted in connection with this document or otherwise.



Preface

Table of Contents

Chapter 0

Section 0

Volume 1	Chapter
Table of Contents	0.0.1
Model Identification	0.1.1
Introduction	0.2.1
Abbreviations	0.3.1
Revision Record	0.4.1
List of Effective Pages	0.5.1
Bulletin Record	0.6.1
Limitations	L
Normal Procedures	NP
Supplementary Procedures	SP
Performance - Dispatch	PD
 Volume 2	
Airplane General, Emergency Equipment, Doors, Windows	1
Air Systems	2
Anti-Ice, Rain	3
Automatic Flight	4
Communications	5
Electrical	6
Engines, APU	7
Fire Protection	8
Flight Controls	9
Flight Instruments, Displays	10
Flight Management, Navigation	11
Fuel	12
Hydraulics	13
Landing Gear	14
Warning Systems	15



Quick Reference Handbook (QRH)

Quick Action Index	QAI
Annunciated Index	ANN
Normal Checklists	NC
Checklist Introduction	CI
Non-Normal Checklists	NNC
Maneuvers	MAN
Performance - Inflight	PI
Index	Index
Evacuation Checklist	EVAC

**General**

The airplanes listed in the table below are covered in the Flight Crew Operations Manual (FCOM). The table information is used to distinguish data peculiar to one or more, but not all of the airplanes. Where data applies to all airplanes listed, no reference is made to individual airplanes.

Airplane number is supplied by the operator. Registry number is supplied by the national regulatory agency. Serial and tabulation number are supplied by Boeing.

Airplane Number	Registry Number	Serial Number	Tabulation Number
571	HA-LOB	29346	YA371
572	HA-LOA	28254	YA372
573	HA-LOI	29350	YA373
574	HA-LOL	29352	YA374
575	HA-LOP	29354	YA375
576	HA-LOR	29355	YA376
577	HA-LOS	29359	YA377
552	HA-LOC	32797	YC201
553	HA-LOH	30667	YC202
555	HA-LOM	30672	YC203
554	HA-LOK	30669	YC206
558	HA-LOU	30684	YC207
803	HA-LOD	28259	YE321
808	HA-LOE	28260	YE322
809	HA-LOF	29348	YE323
810	HA-LOG	28261	YE324
811	HA-LOJ	29349	YE325
813	HA-LON	29353	YE326



Intentionally
Blank

**General**

This Flight Crew Operations Manual (FCOM) has been prepared by The Boeing Company. The purpose of this manual is to:

- provide the necessary operating limitations, procedures, performance, and systems information the flight crew needs to safely and efficiently operate the 737 airplane during all anticipated airline operations
- serve as a comprehensive reference for use during transition training for the 737 airplane
- serve as a review guide for use in recurrent training and proficiency checks
- provide necessary operational data from the FAA approved Airplane Flight Manual (AFM) to ensure that legal requirements are satisfied
- establish standardized procedures and practices to enhance Boeing operational philosophy and policy.

This manual is prepared for the owner/operator named on the title page specifically for the airplanes listed in the "Model Identification" section. It contains operational procedures and information, which apply only to these airplanes. The manual covers the Boeing delivered configuration of these airplanes. Changes to the delivered configuration are incorporated when covered by contractual revision agreements between the owner/operator and The Boeing Company

This manual is not suitable for use for any airplanes not listed in the "Model Identification" section. Further, it may not be suitable for airplanes that have been transferred to other owners/operators.

Owners/operators are solely responsible for ensuring the operational documentation they are using is complete and matches the current configuration of the listed airplanes. This includes the accuracy and validity of all information furnished by the owner/operator or any other party. Owners/operators receiving active revision service are responsible to ensure that any modifications to the listed airplanes are properly reflected in the operational procedures and information contained in this manual.

This manual is structured in a two-volume format with a Quick Reference Handbook (QRH). Volume 1 includes operational limitations, normal and supplementary procedures, and dispatch performance data. Volume 2 contains systems information. The QRH contains all checklists necessary for normal and non-normal procedures as well as in-flight performance data.

The manual is periodically revised to incorporate pertinent procedural and systems information. Items of a more critical nature will be incorporated in operational bulletins and distributed in a timely manner. In all cases, such revisions and changes must remain compatible with the approved AFM with which the operator must comply. In the event of conflict with the AFM, the AFM shall supersede.

This manual is written under the assumption that the user has had previous multi-engine jet aircraft experience and is familiar with basic jet airplane systems and basic pilot techniques common to airplanes of this type. Therefore, the FCOM does not contain basic flight information that is considered prerequisite training.

Any questions about the content or use of this manual can be directed to:

Manager, Flight Training and Technical & Data
737 Model
Boeing Commercial Airplane Groups
P. O. Box 3707, M/C 20-89
Seattle, Washington 98124-2207 USA

Organization

The FCOM is organized in the following manner.

Volume 1

- Preface – contains general information regarding the manual’s purpose, structure, and content. It also contains lists of abbreviations, a record of revisions, bulletins, and a list of effective pages.
- Limitations and Normal Procedures chapters cover operational limitations and normal procedures. All operating procedures are based on a thorough analysis of crew activity required to operate the airplane, and reflect the latest knowledge and experience available.
- Supplementary Procedures chapter covers those procedures accomplished as required rather than routinely on each flight.
- Performance Dispatch chapter contains performance information necessary for self dispatch.

Volume 2 – Chapters 1 through 15 contain general airplane and systems information. These chapters are generally subdivided into sections covering controls and indicators and systems descriptions.

Quick Reference Handbook (QRH) – The QRH covers normal checklists, in-flight performance, non-normal checklists, and non-normal maneuvers.

Page Numbering

The FCOM uses a decimal page numbering system. The page number is divided into three fields; chapter, section, and page. An example of a page number for the hydraulics chapter follows: chapter 13, section 20, page 3.

Example Page Number

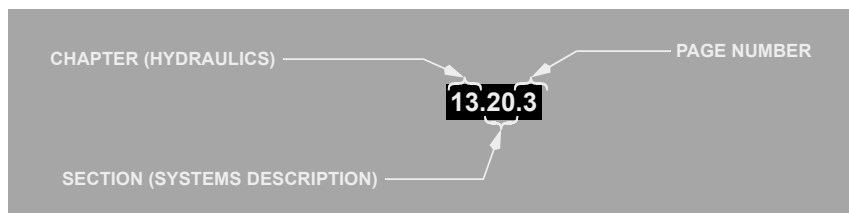

Page Identification

Each page is identified by a customer document number and a page date. The customer document number is composed of the general 737 FCOM number, D6-27370-, and is followed by the airplane model and customer identification.

Example Page Identification

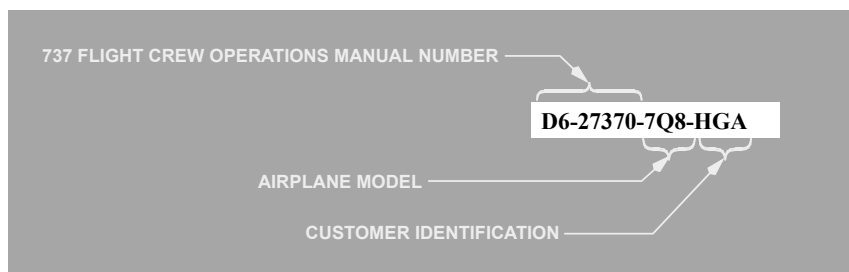

Warnings, Cautions, and Notes

The following levels of written advisories are used throughout the manual.

WARNING: An operating procedure, technique, etc., that may result in personal injury or loss of life if not carefully followed.

CAUTION: An operating procedure, technique, etc., that may result in damage to equipment if not carefully followed.

Note: An operating procedure, technique, etc., considered essential to emphasize. Information contained in notes may also be safety related.



Flight Crew Operations Manual Configuration

Customer airplane configuration determines the data provided in this manual. The Boeing Company keeps a list of each airplane configuration as it is built and modified through the service bulletin process. The FCOM does not reflect customer originated modifications without special contract provisions.

Schematic Symbols

Symbols shown are those which may not be identified on schematic illustrations.

GENERAL				ELECTRICAL			
RESERVOIR	HEAT EXCHANGER	DUAL HEAT EXCHANGER		GENERATOR & GENERATOR DRIVE	BUSSES	INVERTER RESERVOIR	TR UNIT
HYDRAULIC ACTUATOR	ACCUMULATOR	FILTER	BYPASS FILTER	BATTERY	BATTERY CHARGER	VOLTAGE REGULATOR	TIMER
COMPARATOR	PRESSURE SENSOR	TEMPERATURE SENSOR	FAN	GROUND CART	THREE POSITION SWITCH	TWO POSITION SWITCH	SOLENOID ACTUATED SWITCH
PUMP	OVERRIDE MECHANISM	COMPRESSOR	FLOW METER	ONE WAY DIODE	GROUND	PUSH-TYPE ELECTRICAL CONTACT	THERMAL SWITCH
WATER SEPARATOR	APU	APU GENERATOR		CIRCUIT BREAKERS	FUSE	HEATER	
MECHANICAL LINKAGE	SYSTEMS INDICATOR	FLUID FLOW		DISTRIBUTION LINE	SIGNAL, INACTIVE UNDER THE CONDITIONS SHOWN		
				AUDIO DEVICES			
ENGINE DRIVEN HYDRAULIC PUMP	MOTOR DRIVEN HYDRAULIC PUMP	POWER TRANSFER UNIT					
				SPEAKER	CLACKER		
WHEEL	TURBINE	THERMOSTAT	DIAPHRAGM				
				HORN	BELL		

VALVES

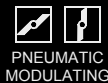

MANUALLY CONTROLLED VALVES



MOTORS AND SOLENOIDS



INDICATORS



**General**

The following abbreviations may be found throughout the manual. Some abbreviations may also appear in lowercase letters. Abbreviations having very limited use are explained in the chapter where they are used.

A	
AC	Alternating Current
ACARS	Aircraft Communications Addressing and Reporting System
ACP	Audio Control Panel
ACT	Active
ADF	Automatic Direction Finder
ADIRS	Air Data Inertial Reference System
ADIRU	Air Data Inertial Reference Unit
ADM	Air Data Module
AFDS	Autopilot Flight Director System
AED	Automatic External Defibrillator
AFM	Airplane Flight Manual (FAA approved)
AGL	Above Ground Level
AI	Anti-Ice
AIL	Aileron
ALT	Altitude
ALTN	Alternate
AM	Amplitude Modulation

ANP	Actual Navigation Performance
ANT	Antenna
AOA	Angle of Attack
A/P	Autopilot
APP	Approach
APU	Auxiliary Power Unit
ARINC	Aeronautical Radio, Incorporated
ARPT	Airport
A/T	Autothrottle
ATA	Actual Time of Arrival
ATC	Air Traffic Control
ATT	Attitude
AUTO	Automatic
AUX	Auxiliary
AVAIL	Available
B	
BAC	Back Course
BARO	Barometric
B/CRS	Back Course
BCS	Back Course
BRT	Bright

BTL DISCH	Bottle Discharge (fire extinguishers)
B/C	Back Course
C	
C	Captain Celsius Center
CANC/ RCL	Cancel/Recall
CAPT	Captain
CB	Circuit Breaker
CDS	Common Display System
CDU	Control Display Unit
CG	Center of Gravity
CHKL	Checklist
CLB	Climb
COMM	Communication
CON	Continuous
CONFIG	Configuration
CRS	Course
CRZ	Cruise
CTL	Control
D	
DC	Direct Current
DDG	Dispatch Deviations Guide
DEP ARR	Departure Arrival
DES	Descent
DEU	Display Electronic Unit
DISC	Disconnect
DME	Distance Measuring Equipment

DSP	Display Select Panel
DSPL	Display
E	
E/D	End of Descent
E/E	Electrical and Electronic
EEC	Electronic Engine Control
EFIS	Electronic Flight Instrument System
EGPWS	Enhanced Ground Proximity Warning System
EGT	Exhaust Gas Temperature
ELEC	Electrical
ELEV	Elevator
EMER	Emergency
ENG	Engine
EO	Engine Out
ETOPS	Extended Range Operation with Twin Engine Airplanes
EVAC	Evacuation
EXEC	Execute
EXT	Extend
F	
F	Fahrenheit
FAC	Final Approach Course
FCOM	Flight Crew Operations Manual
FCTL	Flight Control
F/D or FLT DIR	Flight Director

737 Flight Crew Operations Manual

FMA	Flight Mode Annunciations
FMC	Flight Management Computer
FMS	Flight Management System
F/O	First Officer
FPA	Flight Path Angle
FPM	Feet Per Minute
FPV	Flight Path Vector
FREQ	Frequency
FT	Feet
FWD	Forward
G	
GA	Go-Around
GEN	Generator
GLS	GPS Landing System or GNSS Landing System
G/P	Glidepath
GPS	Global Positioning System
GPWS	Ground Proximity Warning System
GS	Ground Speed
G/S	Glide Slope
H	
HDG	Heading
HDG REF	Heading Reference
HDG SEL	Heading Select
HF	High Frequency
HPA	Hectopascals
HUD	Head-Up Display

HYD	Hydraulic
I	
IAN	Integrated Approach Navigation
IAS	Indicated Airspeed
IDENT	Identification
IFE	In-Flight Entertainment System
IGN	Ignition
IN	Inches
IND LTS	Indicator Lights
ILS	Instrument Landing System
INBD	Inboard
INOP	Inoperative
INT or INTPH	Interphone
INTC CRS	Intercept Course
IRS	Inertial Reference System
ISFD	Integrated Standby Flight Display
ISLN	Isolation
K	
K	Knots
KGS	Kilograms
KIAS	Knots Indicated Airspeed
L	
L	Left
LBS	Pounds
LDA	Localizer type Directional Aid
LDG ALT	Landing Altitude

737 Flight Crew Operations Manual

LIM	Limit
LNAV	Lateral Navigation
LOC	Localizer
LWR CTR	Lower Center
LWR DSPL	Lower Display
M	
M	Mach
MAG	Magnetic
MAN	Manual
MCP	Mode Control Panel
MDA	Minimum Descent Altitude
MEL	Minimum Equipment List
MFD	Multifunction Display
MHZ	Megahertz
MIC	Microphone
MIN	Minimum
MKR	Marker
MMO	Maximum Mach Operating Speed
MOD	Modify
MSG	Message
MTRS	Meters
MUH	Minimum Use Height
N	
NAV RAD	Navigation Radio
ND	Navigation Display
NM	Nautical Miles
NORM	Normal

NPS	Navigation Performance Scales
N1	Low Pressure Rotor Speed
N2	High Pressure Rotor Speed
O	
OAT	Outside Air Temperature
OFST	Offset
OHU	Overhead Unit
OUTBD DSPL	Outboard Display
OVHD	Overhead
OVHT	Overheat
OVRD	Override
OXY or O2	Oxygen
P	
PA	Passenger Address
PASS	Passenger
PERF INIT	Performance Initialization
PF	Pilot Flying
PFC	Primary Flight Computers
PFD	Primary Flight Display
PM	Pilot Monitoring
PNF	Pilot Not Flying
PNL	Panel
POS	Position
PREV	Previous
PROX	Proximity
POS INIT	Position Initialization

737 Flight Crew Operations Manual

PRI	Primary
PSI	Pounds Per Square Inch
PTH	Path
PTT	Push To Talk
PWR	Power
PWS	Predictive Windshear System
R	
R	Right
RA	Radio Altitude Resolution Advisory
RDMI	Radio Distance Magnetic Indicator
REC	Recorder
RECIRC	Recirculation
REF	Reference
RET	Retract
RF	Refill
RNP	Required Navigation Performance
RPM	Revolutions Per Minute
RST	Reset
RTE	Route
RTO	Rejected Takeoff
RTP	Radio Tuning Panel
RUD	Rudder
RVSM	Reduced Vertical Separation Minimum
S	
SAT	Static Air Temperature
S/C	Step Climb

SDF	Simplified Directional Facility
SELCAL	Selective Calling
SEL	Select
SPD	Speed
STA	Station
STAB	Stabilizer
STAT	Status
STBY	Standby
STD	Standard
SYS	System
T	
T or TRU	True
T or TK or TRK	Track
TA	Traffic Advisory
TAS	True Airspeed
TAT	Total Air Temperature
T/C	Top of Climb
TCAS	Traffic Alert and Collision Avoidance System
TDZE	Touch Down Zone Elevation
T/D	Top of Descent
TEMP	Temperature
TERR	Terrain
TFC	Traffic
TFR	Transfer
THR HOLD	Throttle Hold
TO	Takeoff

TO/GA	Takeoff/Go-Around
TRU	Transformer Rectifier Unit
U	
UNLKD	Unlocked
USB	Upper Side Band
UPR DSPL	Upper Display
UTC	Coordinated Universal Time
UTIL	Utility
V	
VA	Design Maneuvering Speed
VANP	Vertical Actual Navigation Performance
VERT	Vertical
VHF	Very High Frequency
VMO	Maximum Operating Speed
VNAV	Vertical Navigation
VOR	VHF Omnidirectional Range
VR	Rotation Speed
VREF	Reference Speed
VRNP	Vertical Required Navigation Performance
VSD	Vertical Situation Display
VSI	Vertical Speed Indicator
V/S	Vertical Speed
VTK	Vertical Track
V1	Takeoff Decision Speed
V2	Scheduled Takeoff Target Speed

W	
WPT	Waypoint
WXR	Weather Radar
X	
XPDR or XPNDR	Transponder
XTK	Cross Track



Revision Transmittal Letter

To: All holders of MALEV Hungarian Airlines (Magyar Legikozlekedesi Vallalat) 737 Flight Crew Operations Manual (FCOM), Boeing Document Number D6-27370-7Q8-HGA.

Subject: Flight Crew Operations Manual Revision.

This revision reflects the most current information available to The Boeing Company 45 days before the subject revision date. The following revision highlights explain changes in this revision. General information below explains the use of revision bars to identify new or revised information.

Revision Record

No.	Revision Date	Date Filed
0	September 30, 2002	
2	September 26, 2003	
4	September 27, 2004	
6	September 29, 2005	

No.	Revision Date	Date Filed
1	March 31, 2003	
3	February 13, 2004	
5	March 28, 2005	

General

The Boeing Company issues FCOM revisions to provide new or revised procedures and information. Formal revisions also incorporate appropriate information from previously issued FCOM bulletins.

The revision date is the approximate date the manual is approved for printing. The revision is mailed a few weeks after this date.

Formal revisions include a Transmittal Letter, a new Revision Record, Revision Highlights, and a current List of Effective Pages. Use the information on the new Revision Record and List of Effective Pages to verify the FCOM content.

Pages containing revised technical material have revision bars associated with the changed text or illustration. Editorial revisions (for example, spelling corrections) may have revision bars with no associated highlight.

The Revision Record should be completed by the person incorporating the revision into the manual.

Filing Instructions

Consult the List of Effective Pages (0.5). Pages identified with an asterisk (*) are either replacement pages or new (original) issue pages. Remove corresponding old pages and replace or add new pages. Remove pages that are marked DELETED; there are no replacement pages for deleted pages.

Be careful when inserting changes not to throw away pages from the manual that are not replaced. Using the List of Effective Pages (0.5) can help determine the correct content of the manual.

Revision Highlights

This section (0.4) replaces the existing section 0.4 in your manual.

Throughout the manual, airplane effectivity may be updated to reflect coverage as listed on the Preface - Model Identification page, or to show service bulletin airplane effectivity. Highlights are not supplied.

This manual is published from a database; the text and illustrations are marked with configuration information. Occasionally, because the editors rearrange the database markers, or mark items with configuration information due to the addition of new database content, some customers may receive revision bars on content that appears to be unchanged. Pages may also be republished without revision bars due to slight changes in the flow of the document.

Chapter 0 - Preface

Section 2 - Introduction

0.2.2 - Updated mailing address to reflect organizational changes.

Section 3 - Abbreviations

0.3.4 - Updated Abbreviations table to add PM - Pilot Monitoring.

Chapter L - Limitations

Section 10 - Operating Limitations

Non-AFM Operational Information

L.10.1 - Reformatted Non-AFM Operational Information and descriptive
Note: throughout chapter for consistency and standardization across models.

Weight Limitations

L.10.3 - Added AFM certified airplane weights (kgs) of 73,935 Taxi, 73,708
T/O, 65,317 Land & 61,688 ZFW.

737 Flight Crew Operations Manual

Autopilot/Flight Director System

L.10.4 - Revised maximum allowable crosswind limit to 20 knots when conducting a dual channel Cat II or Cat III landing predicated on autoland operations.

QFE Selection

L.10.6 - Deleted limitation on GPWS terrain awareness alerting and terrain display function when QFE is selected.

Fuel System

L.10.7 - Added Fuel Balance title for standardization across models.

L.10.7 - Deleted the following Limitation: "The crossfeed valve must be closed for takeoff and landing". This was done to maintain standardization with the AFM.

Chapter NP - Normal Procedures**Section 11 - Introduction****Areas of Responsibility - Captain as Pilot Flying or Taxiing**

NP.11.5 - Administrative change.

Areas of Responsibility - First Officer as Pilot Flying or Taxiing

NP.11.6 - Administrative change.

Section 21 - Amplified Procedures**Preliminary Preflight Procedure – Captain or First Officer**

NP.21.2 - Deleted redundant information.

NP.21.2 - Added specific circuit breaker panel location for clarity.

CDU Preflight Procedure - Captain and First Officer

NP.21.4 - Admin change.

Preflight Procedure – First Officer

NP.21.14 - Added CAUTION previously omitted.

NP.21.14 - Deleted APU DC fuel pump.

NP.21.17 - Added a step to set the COURSE on the MCP as this step is in the first officer's area of responsibility.

NP.21.18 - Added steps to check for a rapid pressure drop, a pressure drop of more than 100 psig or a slow recovery in pressure because an incorrect configuration of the oxygen cylinder valve may not be apparent with the current procedure. Air in the lines may be sufficient to show correct indications even with the valve closed or only partially open.

NP.21.19 - The preflight procedure inadvertently reference the captain's preflight procedure in the Flight Instruments check. Changed to reference the Before Start procedure.

NP.21.20 - Added a statement that the test is needed once per flight day or following a crew change to be in line with certification requirements,

Preflight Procedure – Captain

NP.21.23 - Added steps to check for a rapid pressure drop, a pressure drop of more than 100 psig or a slow recovery in pressure because an incorrect configuration of the oxygen cylinder valve may not be apparent with the current procedure. Air in the lines may be

NP.21.25 - The preflight procedure inadvertently reference the captain's preflight procedure in the Flight Instruments check. Changed to reference the Before Start procedure.

Engine Start Procedure

NP.21.30 - Changed CRM information to indicate that the engine start switches should be moved by the F/O.

NP.21.31 - Step changed to relate the normal procedure conditions to those conditions in NNC's.

Before Taxi Procedure

NP.21.32 - Added transponder Mode S ground tracking information.

After Landing Procedure

NP.21.49 - Added transponder Mode S ground tracking information.

Chapter SP - Supplementary Procedures

Section 1 - Airplane General, Emer. Equip., Doors, Windows

Oxygen Mask Microphone Test

SP.1.3 - Added new Supplementary Procedure.

Section 2 - Air Systems

Takeoff

SP.2.6 - Changed because the Isolation Valve switch does not have an "ON" position.

Section 3 - Anti-Ice, Rain

Power Test

SP.3.4 - Changed Note for clarity.

737 Flight Crew Operations Manual

Section 6 - Electrical

Electrical Power Up

SP.6.1 - Changed for clarity.

Section 7 - Engines, APU

Battery Start

SP.7.1 - Revised the Battery Start Supplementary Procedure to bring it in line with the standardized Normal Procedures and Normal Checklists.

SP.7.1 - Added ISFD preflight information.

Setting N1 Bugs with an Inoperative FMC

SP.7.5 - Deleted the APU Start Supplementary Procedure because the Electrical Power Up Supplementary Procedure in SP 6 includes steps to start the APU. This change affects Normal Procedures and Limitations as well.

Section 10 - Flight Instruments, Displays

QFE Operation

SP.10.2 - Deleted requirement to select the terrain inhibit switch to TERRAIN INHIBIT during QFE operations for airplanes without the -204 Look-Ahead Terrain Alerting System, or for airplanes with the new -212 Look-Ahead Terrain Alerting System installed.

Section 11 - Flight Management, Navigation

IRS Entries

SP.11.4 - Changed for 737 cross-model standardization.

Section 16 - Adverse Weather

Introduction

SP.16.1 - Revised Supplementary Procedures to match the new standardized Normal Procedures. This change affects multiple pages in this chapter/section.

SP.16.1 - Deleted reference to crosswinds when operating from slippery runways.

Hot Weather Operation

SP.16.13 - Added 737-600 and 737-700 information.

Precautions

SP.16.16 - Revised for clarity.

Chapter PD - Performance Dispatch

Section 11 - Enroute

Flight Crew Oxygen Requirements

PD.11.6 - Corrected typo, as 35 degrees C are equivalent to 95 degrees F.

Section 21 - Enroute

Flight Crew Oxygen Requirements

PD.21.6 - Corrected typo, as 35 degrees C are equivalent to 95 degrees F.

Section 31 - Enroute

Flight Crew Oxygen Requirements

PD.31.6 - Corrected typo, as 35 degrees C are equivalent to 95 degrees F.

Chapter 4 - Automatic Flight

Section 20 - System Description

Autothrottle Disengagement

4.20.8 - Changed description of Autothrottle Disengagement for airplanes with Collins EDFCS.

Chapter 5 - Communications

Section 10 - Controls and Indicators

Radio Tuning Panel

5.10.1 - Revised HF SENS control to reflect proper panel configuration.

5.10.2 - Added text stating DATA is displayed in the ACTIVE Frequency Indicator if the selected radio is in the data mode.

Chapter 7 - Engines, APU

Section 10 - Side by Side – Displays

N1 Indications

7.10.4 - Reference N1 Readouts - revised description of indications for commonality among display options.

Section 11 - Over/Under – Displays

N1 Indications

7.11.4 - Reference N1 Readouts - revised description of indications for commonality among display options.

737 Flight Crew Operations Manual

Section 30 - APU System Description**APU Start**

- 7.30.2 - Added Note regarding fluctuating indications during APU start cycle. This Note was in "APU Start" which was removed from SP 7.

Chapter 10 - Flight Instruments, Displays**Section 16 - EFIS Instruments (PFD) – Controls****Standby Radio Magnetic Indicator**

- 10.16.19 - Corrected inadvertent deletion of bearing pointer information.

Section 20 - EFIS/Map System Description**Integrated Standby Flight Display (ISFD)**

- 10.20.14 - Added heading information.

Aircraft Condition Monitoring System (ACMS)

- 10.20.15 - Added aircraft condition monitoring system.

Section 21 - PFD/ND System Description**Integrated Standby Flight Display (ISFD)**

- 10.21.14 - Added heading information.

Aircraft Condition Monitoring System (ACMS)

- 10.21.16 - Added aircraft conditioning monitoring system.

Section 40 - Navigation Displays**MAP**

- 10.40.11 - Added TERR map switch to range arc display conditions.

TCAS

- 10.40.14 - Corrected TCAS arrow remarks text.

Section 41 - PFD/ND Navigation Displays**Map**

- 10.41.12 - Added TERR map switch to range arc display conditions.

TCAS

- 10.41.15 - Corrected TCAS arrow remarks text.

Chapter 11 - Flight Management, Navigation

Section 31 - Flight Management System Operation

Descent

11.31.22 - Deleted sentence "To maintain a path...LNAV course." from paragraph.

Section 32 - Flight Management Computer

Thrust Management

11.32.2 - Revised maximum thrust reduction altitude from "15,000" to "9,999" feet.

Section 40 - FMC Preflight

Takeoff Reference Page 2/2

11.40.40 - Revised maximum thrust reduction altitude from "15,000" to "9,999" feet.

Section 41 - FMC Takeoff and Climb

Engine Out Climb Page

11.41.27 - Changed "TGT SPD" to "ENG OUT SPD" and added reverse highlight.

11.41.27 - Revised title for standardization.

11.41.28 - Added FMC Update U10.3 or later.

11.41.28 - Revised callout from "TGT SPD" to "ENG OUT SPD".

11.41.28 - Revised callout from "ENG OUT" to "LT ENG OUT/RT ENG OUT".

Section 43 - FMC Descent and Approach

Arrivals Page – IFR Approaches

11.43.15 - Resized graphic.

Section 60 - FMC Messages

FMC Alerting Messages

11.60.10 - Deleted "Inhibited during approach".

737 Flight Crew Operations Manual

Chapter 12 - Fuel**Section 10 - Controls and Indicators**

Fuel Control Panel

12.10.3 - Added additional system information on the operation of the center tank FUEL PUMP LOW PRESSURE and MASTER CAUTION lights.

Chapter 14 - Landing Gear**Section 20 - System Description**

Antiskid Protection

14.20.4 - Added information to clarify antiskid operation when both normal and alternate brake system pressure has been lost.

Chapter 15 - Warning Systems**Section 10 - Controls and Indicators**

Altitude Alert

15.10.4 - Deleted 300/900 altitude alert.

Section 20 - System Description

Stall Warning System

15.20.8 - Deleted 300/900 altitude alert.

Chapter CI - Checklist Introduction**Section 2 - Non-Normal Checklists**

Non-Normal Checklist Use

CI.2.4 - The purpose of the Condition Statement is to help the flight crew verify that they have selected the correct checklist. Once this has been determined, there is no need to continue to read information that does not assist the crew further.

Chapter NNC - Non-Normal Checklists**Section 0 - Unannunciated Checklists**

EMERGENCY DESCENT

0.12 - Changed step to read "CONT" rather than "ON" for cross-model standardization.

STABILIZER TRIM INOPERATIVE

0.26 - Procedure changed to standardize with FCTM recommendations. Also, separated the jammed condition from the motor failure condition.

TAILSTRIKE ON TAKEOFF

0.28 - Added "Plan to land at the nearest suitable airport" step for Boeing model standardization.

UNCOMMANDED RUDDER/YAW OR ROLL

0.30 - Standardized with the new Normal Checklists.

VOLCANIC ASH

0.33 - Added new Checklist END symbol.

Section 1 - Airplane General, Emer. Equip., Doors, Windows

DOOR ANNUNCIATOR

1.2 - Added new Checklist END symbol.

TAILSTRIKE ON TAKEOFF

1.5 - Added "Plan to land at the nearest suitable airport" step for Boeing model standardization.

WINDOW DAMAGE

1.6,8 - Revised procedure to account for those airplanes without windows #4 and #5.

Section 2 - Air Systems

EMERGENCY DESCENT

2.7 - Changed step to read "CONT" rather than "ON" for cross-model standardization.

OFF SCHEDULE DESCENT

2.8 - Changed for standardization of format and added an End element.

Section 3 - Anti-Ice, Rain

ENGINE COWL VALVE OPEN/TAI INDICATION

3.1 - Added new Checklist END symbol.

Section 7 - Engines, APU

APU FIRE

7.2 - The current procedure is too restrictive in that the crew is directed to land in all cases. Procedure revised to be consistent with the AFM.

EEC ALTERNATE MODE

7.3 - Changed for clarity.

737 Flight Crew Operations Manual

ENGINE CONTROL

7.4 - Added a statement that dispatch is not authorized.

ENGINE LOW OIL PRESSURE

7.13 - Added new Checklist END symbol.

ENGINE TAILPIPE FIRE

7.16 - Added expanding information.

7.16 - Corrected indent of steps.

VOLCANIC ASH

7.27 - Added new Checklist END symbol.

Section 8 - Fire Protection**APU FIRE**

8.3 - The current procedure is too restrictive in that the crew is directed to land in all cases. Procedure revised to be consistent with the AFM.

ENGINE TAILPIPE FIRE

8.9 - Added expanding information.

8.9 - Corrected indent of steps.

Section 9 - Flight Controls**LEADING EDGE FLAPS TRANSIT**

9.7 - Changed for standardization.

9.8 - Revised the steps to be correct for all failure conditions.

STABILIZER TRIM INOPERATIVE

9.12 - Procedure changed to standardize with FCTM recommendations. Also, separated the jammed condition from the motor failure condition.

TRAILING EDGE FLAP DISAGREE

9.20 - Changed indentation for Boeing cross-model standardization.

TRAILING EDGE FLAPS UP LANDING

9.22 - Added new Checklist END symbol.

9.24 - Revised to show that the light may be green or amber depending on the cause of the failure.

UNCOMMANDED RUDDER/YAW OR ROLL

9.26 - Standardized with the new Normal Checklists.

Section 10 - Flight Instruments, Displays

CDS FAULT

10.2 - Added a statement that dispatch is not authorized.

DSPLY SOURCE

10.3 - Changed to clarify the statement. It is possible for NONE of the additional indications to occur in conjunction with the annunciation.

Section 12 - Fuel

LOW

12.9 - Added new Checklist END symbol.

Chapter MAN - Maneuvers

Section 2 - Flight Patterns

ILS Approach - Fail Passive

MAN.2.2 - Deleted ILS Approach Profile for airplanes equipped with Fail Operational Automatic Approach and Landing capability to match fleet configuration.

Instrument Approach Using VNAV

MAN.2.3 - Deleted Instrument Approach Profile for airplanes with Integrated Approach Navigation (IAN) to match fleet configuration.

Chapter PI - Performance Inflight

Section 10 - General

Flap Maneuver Speeds

PI.10.4 - Deleted Flaps 2 to make data consistent with other 737 models.

Section 12 - Advisory Information

Normal Configuration Landing Distances

PI.12.1,3 - In cases where the reference distance for lower autobrake settings showed better performance than max autobrake, the reference distance was adjusted to be the same as max autobrake. This was done to more accurately reflect autobrake characteristics on slippery runways. Also, simplified the notes and added a landing distance adjustment for max manual braking using manual speedbrakes.

737 Flight Crew Operations Manual

Non-Normal Configuration Landing Distance

PI.12.4 - Changed the title of the JAMMED STABILIZER Non-Normal Landing Distance to correspond with recently revised title of the associated STABILIZER TRIM INOPERATIVE Non-Normal Checklist and resorted table alphabetically. Actual landing distances have not change

Section 20 - General**Flap Maneuver Speeds**

PI.20.4 - Deleted Flaps 2 to make data consistent with other 737 models.

Section 22 - Advisory Information**Normal Configuration Landing Distances**

PI.22.1,3 - In cases where the reference distance for lower autobrake settings showed better performance than max autobrake, the reference distance was adjusted to be the same as max autobrake. This was done to more accurately reflect autobrake characteristics on slippery runways. Also, simplified the notes and added a landing distance adjustment for max manual braking using manual speedbrakes.

Section 30 - General**Flap Maneuver Speeds**

PI.30.4 - Deleted Flaps 2 to make data consistent with other 737 models.

Takeoff Speeds - Wet Runway (24K Derate)

PI.30.15 - Extended coverage up to 10000 ft.

Section 32 - Advisory Information**Normal Configuration Landing Distances**

PI.32.1,3 - In cases where the reference distance for lower autobrake settings showed better performance than max autobrake, the reference distance was adjusted to be the same as max autobrake. This was done to more accurately reflect autobrake characteristics on slippery runways. Also, simplified the notes and added a landing distance adjustment for max manual braking using manual speedbrakes.



Intentionally
Blank



737 Flight Crew Operations Manual

Preface

Chapter 0

List of Effective Pages

Section 5

Page	Date
Volume 1	
* Title Page	September 29, 2005
* Copyright	September 29, 2005
* 0.RevNotice.1-2	Deleted
0.0.1	February 13, 2004
0.0.2	March 28, 2005
* 0.1.1	September 29, 2005
0.1.2	September 30, 2002
0.2.1	February 13, 2004
* 0.2.2	September 29, 2005
0.2.3-4	February 13, 2004
0.2.5	March 31, 2003
0.2.6	September 30, 2002
0.3.1-3	February 13, 2004
* 0.3.4-6	September 29, 2005
* 0.4.1-14	September 29, 2005
* 0.5.1-14	September 29, 2005
Bulletins (tab)	
* 0.6.1-2	September 29, 2005
Limitations (tab)	
* L.TOC.0.1-2	September 29, 2005
* L.10.1	September 29, 2005
L.10.2	September 27, 2004
* L.10.3-4	September 29, 2005
L.10.5	March 28, 2005
* L.10.6-7	September 29, 2005
L.10.8	September 27, 2004

Page	Date
Normal Procedures (tab)	
* NP.TOC.0.1-2	September 29, 2005
NP.11.1-4	March 28, 2005
* NP.11.5-6	September 29, 2005
NP.21.1	March 28, 2005
* NP.21.2	September 29, 2005
NP.21.3	March 28, 2005
* NP.21.4	September 29, 2005
NP.21.5-12	March 28, 2005
* NP.21.13-54	September 29, 2005
Supplementary Procedures (tab)	
* SP.TOC.0.1-6	September 29, 2005
SP.05.1-2	September 30, 2002
SP.1.1	March 31, 2003
SP.1.2	September 26, 2003
* SP.1.3	September 29, 2005
SP.1.4	March 31, 2003
SP.2.1	March 28, 2005
SP.2.2-4	February 13, 2004
SP.2.5	September 27, 2004
* SP.2.6	September 29, 2005
SP.3.1-3	March 28, 2005
* SP.3.4	September 29, 2005
SP.4.1	September 30, 2002
SP.4.2-6	September 26, 2003
SP.5.1-2	February 13, 2004
* SP.6.1	September 29, 2005
SP.6.2-4	March 28, 2005
* SP.7.1-5	September 29, 2005

* = Revised, Added, or Deleted

Copyright © The Boeing Company. See title page for details.



737 Flight Crew Operations Manual

Page	Date	Page	Date
Supplementary Procedures (cont)		Performance - Dispatch (cont)	
SP.7.6	September 30, 2002	PD.13.5	September 27, 2004
SP.8.1-2	September 30, 2002	PD.13.6	February 13, 2004
SP.9.1-4	February 13, 2004	PD.20.1-6	February 13, 2004
SP.10.1	February 13, 2004	PD.20.7	September 27, 2004
* SP.10.2	September 29, 2005	PD.20.8	February 13, 2004
SP.10.3	February 13, 2004	PD.21.1-5	February 13, 2004
SP.10.4	March 28, 2005	* PD.21.6	September 29, 2005
SP.11.1-2	February 13, 2004	PD.21.7	February 13, 2004
SP.11.3	September 27, 2004	PD.21.8-9	September 27, 2004
* SP.11.4	September 29, 2005	PD.21.10	February 13, 2004
SP.11.5-12	February 13, 2004	PD.22.1	September 27, 2004
* SP.11.13	September 29, 2005	* PD.22.2	September 29, 2005
SP.11.14-18	February 13, 2004	PD.22.3	September 27, 2004
SP.11.19	March 28, 2005	* PD.22.4	September 29, 2005
SP.11.20	February 13, 2004	PD.22.5-8	September 27, 2004
SP.12.1	March 31, 2003	PD.23.1-4	February 13, 2004
SP.12.2-4	September 30, 2002	PD.23.5	September 27, 2004
* SP.16.1-18	September 29, 2005	PD.23.6	February 13, 2004
Performance - Dispatch (tab)		PD.30.1-6	February 13, 2004
PD.TOC.0.1-4	September 27, 2004	PD.30.7	September 27, 2004
PD.10.1-10	February 13, 2004	PD.30.8	February 13, 2004
PD.11.1-5	February 13, 2004	PD.31.1-5	February 13, 2004
* PD.11.6	September 29, 2005	* PD.31.6	September 29, 2005
PD.11.7-10	February 13, 2004	PD.31.7	February 13, 2004
PD.12.1	February 13, 2004	PD.31.8-9	September 27, 2004
PD.12.2-3	September 27, 2004	PD.31.10	February 13, 2004
PD.12.4-5	February 13, 2004	PD.32.1-2	February 13, 2004
PD.12.6	September 27, 2004	PD.32.3	September 27, 2004
PD.12.7-8	February 13, 2004	PD.32.4	February 13, 2004
PD.13.1-4	February 13, 2004	PD.33.1-6	February 13, 2004

* = Revised, Added, or Deleted



737 Flight Crew Operations Manual

Page	Date
Performance - Dispatch (cont)	
* NP.10.1-6	Deleted
* NP.20.1-46	Deleted
* NP.30.1-6	Deleted
(blank tab)	

* = Revised, Added, or Deleted

Copyright © The Boeing Company. See title page for details.



737 Flight Crew Operations Manual

Page	Date	Page	Date
Volume 2		1 Airplane General, Emergency Equipment, Doors, Windows (cont)	
1 Airplane General, Emergency Equipment, Doors, Windows (tab)		1.40.16	March 28, 2005
1.TOC.0.1-4	March 28, 2005	1.40.17-19	September 30, 2002
1.10.1	February 13, 2004	1.40.20	September 26, 2003
1.10.2	September 27, 2004	1.40.21	February 13, 2004
1.10.3-4	March 28, 2005	1.40.22	September 27, 2004
1.10.5	September 27, 2004	1.40.23	February 13, 2004
1.10.6	March 28, 2005	1.40.24	March 28, 2005
1.20.1-3	February 13, 2004	1.40.25-26	September 27, 2004
1.20.4	September 27, 2004	1.40.27-29	March 28, 2005
1.20.5-16	February 13, 2004	1.40.30-31	February 13, 2004
1.30.1-4	February 13, 2004	1.40.32	March 28, 2005
1.30.5-6	March 28, 2005	1.40.33	September 27, 2004
1.30.7	February 13, 2004	1.40.34-35	March 28, 2005
1.30.8	March 28, 2005	1.40.36	September 27, 2004
1.30.9-10	September 26, 2003	1.40.37	March 28, 2005
1.30.11	February 13, 2004	1.40.38-40	February 13, 2004
1.30.12	September 26, 2003	2 Air Systems (tab)	
1.30.13	September 27, 2004	2.TOC.0.1-4	February 13, 2004
1.30.14	March 28, 2005	2.10.1	September 27, 2004
1.30.15-16	September 26, 2003	2.10.2	March 28, 2005
1.30.17	September 27, 2004	2.10.3	September 27, 2004
1.30.18	September 26, 2003	2.10.4	March 28, 2005
1.30.19-22	March 28, 2005	2.10.5-6	September 27, 2004
1.40.1	September 30, 2002	2.10.7-8	September 26, 2003
1.40.2	March 28, 2005	2.10.9	March 28, 2005
1.40.3-7	September 30, 2002	2.10.10-16	September 26, 2003
1.40.8	September 27, 2004	2.20.1-2	September 30, 2002
1.40.9	March 28, 2005	2.20.3	September 27, 2004
1.40.10-15	September 30, 2002	2.20.4	March 28, 2005

* = Revised, Added, or Deleted



737 Flight Crew Operations Manual

Page	Date	Page	Date
2 Air Systems (cont)		4 Automatic Flight (cont)	
2.20.5	September 27, 2004	4.10.12-13	March 31, 2003
2.20.6	March 28, 2005	4.10.14	September 27, 2004
2.30.1	September 27, 2004	* 4.10.15	September 29, 2005
2.30.2-5	September 30, 2002	4.10.16-19	September 26, 2003
2.30.6	February 13, 2004	4.10.20	February 13, 2004
2.30.7	September 27, 2004	4.10.21	September 27, 2004
2.30.8	September 26, 2003	4.10.22	March 28, 2005
2.31.1	March 28, 2005	4.10.23-26	September 27, 2004
2.31.2-8	September 30, 2002	4.20.1	September 30, 2002
2.40.1-2	September 30, 2002	4.20.2-3	March 28, 2005
2.40.3	March 28, 2005	4.20.4	September 27, 2004
2.40.4	September 30, 2002	4.20.5-7	March 28, 2005
2.40.5-7	March 31, 2003	* 4.20.8-10	September 29, 2005
2.40.8	September 26, 2003	4.20.11	February 13, 2004
3 Anti-Ice, Rain (tab)		4.20.12	March 28, 2005
3.TOC.0.1-2	September 27, 2004	4.20.13-15	September 27, 2004
3.10.1-6	September 30, 2002	4.20.16	February 13, 2004
3.20.1	September 30, 2002	4.20.17	September 27, 2004
3.20.2-4	March 28, 2005	4.20.18-20	September 26, 2003
3.20.5-8	September 27, 2004	4.20.21	February 13, 2004
4 Automatic Flight (tab)		4.20.22	September 27, 2004
4.TOC.0.1-2	March 28, 2005	4.20.23-26	September 26, 2003
* 4.10.1	September 29, 2005		
4.10.2-3	March 31, 2003		
* 4.10.4	September 29, 2005		
4.10.5	March 31, 2003		
4.10.6	September 27, 2004		
4.10.7-9	March 31, 2003		
* 4.10.10	September 29, 2005		
4.10.11	September 26, 2003		

* = Revised, Added, or Deleted

Copyright © The Boeing Company. See title page for details.



737 Flight Crew Operations Manual

Page	Date	Page	Date
5 Communications (tab)		7 Engines, APU (cont)	
5.TOC.0.1-2	September 27, 2004	* 7.10.4	September 29, 2005
* 5.10.1-6	September 29, 2005	7.10.5	September 30, 2002
5.10.7	September 27, 2004	7.10.6	March 28, 2005
5.10.8-11	February 13, 2004	7.10.7-9	September 30, 2002
5.10.12-18	September 27, 2004	7.10.10	September 27, 2004
5.20.1	September 30, 2002	7.10.11-12	September 30, 2002
5.20.2	September 27, 2004	7.11.1	September 27, 2004
5.20.3	March 28, 2005	7.11.2-3	September 26, 2003
5.20.4-6	September 27, 2004	* 7.11.4	September 29, 2005
5.20.7	March 28, 2005	7.11.5	September 26, 2003
5.20.8	September 27, 2004	7.11.6-7	March 28, 2005
6 Electrical (tab)		7.11.8-10	September 26, 2003
6.TOC.0.1-2	September 26, 2003	7.11.11	March 28, 2005
6.10.1-3	September 30, 2002	7.11.12-13	September 26, 2003
6.10.4	March 28, 2005	7.11.14	February 13, 2004
6.10.5	September 30, 2002	7.11.15-16	September 27, 2004
6.10.6	September 27, 2004	7.15.1	September 30, 2002
6.10.7-10	September 30, 2002	7.15.2-3	September 27, 2004
6.20.1-3	September 30, 2002	7.15.4-8	September 26, 2003
6.20.4	March 31, 2003	7.20.1	February 13, 2004
6.20.5-12	September 30, 2002	7.20.2	September 27, 2004
6.20.13	September 27, 2004	7.20.3	September 26, 2003
6.20.14	March 28, 2005	7.20.4	September 27, 2004
* 6.20.15	September 29, 2005	7.20.5-8	September 26, 2003
6.20.16	February 13, 2004	7.20.9	March 28, 2005
6.20.17-18	September 27, 2004	7.20.10	September 27, 2004
7 Engines, APU (tab)		7.20.11-14	September 26, 2003
7.TOC.0.1-4	September 26, 2003	7.30.1	September 30, 2002
7.10.1	February 13, 2004	* 7.30.2-3	September 29, 2005
7.10.2-3	September 30, 2002	7.30.4	September 30, 2002

* = Revised, Added, or Deleted



737 Flight Crew Operations Manual

Page	Date	Page	Date
8 Fire Protection (tab)		10 Flight Instruments, Displays (cont)	
8.TOC.0.1-2	September 26, 2003	10.11.1	September 27, 2004
8.10.1-5	September 30, 2002	10.11.2-9	September 26, 2003
8.10.6	September 27, 2004	10.11.10-11	March 28, 2005
8.10.7-8	September 30, 2002	10.11.12-17	September 26, 2003
8.20.1-5	September 30, 2002	10.11.18	March 28, 2005
8.20.6	March 28, 2005	10.11.19-21	September 26, 2003
8.20.7-10	September 26, 2003	10.11.22-23	March 28, 2005
9 Flight Controls (tab)		10.11.24-50	September 27, 2004
9.TOC.0.1-2	February 13, 2004	10.15.1	February 13, 2004
9.10.1	September 30, 2002	10.15.2-9	March 28, 2005
9.10.2-3	February 13, 2004	10.15.10-11	September 26, 2003
9.10.4-10	September 30, 2002	10.15.12-14	February 13, 2004
9.10.11	February 13, 2004	10.15.15	March 28, 2005
9.10.12	September 27, 2004	10.15.16-18	September 26, 2003
9.10.13	March 28, 2005	10.16.1	September 27, 2004
9.10.14-16	September 26, 2003	10.16.2-6	March 28, 2005
9.20.1-7	September 30, 2002	10.16.7-9	February 13, 2004
9.20.8	March 28, 2005	10.16.10-11	September 27, 2004
9.20.9	September 30, 2002	10.16.12	February 13, 2004
9.20.10	March 31, 2003	10.16.13-14	September 27, 2004
9.20.11-18	February 13, 2004	10.16.15-18	February 13, 2004
9.20.19	March 28, 2005	* 10.16.19	September 29, 2005
9.20.20-24	February 13, 2004	10.16.20-24	March 28, 2005
10 Flight Instruments, Displays (tab)		10.20.1-2	February 13, 2004
* 10.TOC.0.1-10	September 29, 2005	10.20.3-13	September 30, 2002
10.10.1	February 13, 2004	* 10.20.14-15	September 29, 2005
10.10.2-14	September 30, 2002	10.20.16	September 30, 2002
10.10.15-18	March 31, 2003	10.21.1	September 27, 2004
10.10.19	February 13, 2004	10.21.2	February 13, 2004
10.10.20-52	March 31, 2003	10.21.3-12	September 26, 2003

* = Revised, Added, or Deleted

Copyright © The Boeing Company. See title page for details.



737 Flight Crew Operations Manual

Page	Date	Page	Date
10 Flight Instruments, Displays (cont)		11 Flight Management, Navigation (cont)	
10.21.13	September 27, 2004	11.10.5-9	September 27, 2004
* 10.21.14	September 29, 2005	11.10.10-15	February 13, 2004
10.21.15	September 27, 2004	11.10.16	September 27, 2004
* 10.21.16	September 29, 2005	11.10.17-22	February 13, 2004
10.30.1	February 13, 2004	11.20.1	September 30, 2002
10.30.2	March 28, 2005	11.20.2	September 27, 2004
10.30.3	February 13, 2004	11.20.3-5	September 30, 2002
10.30.4	September 30, 2002	11.20.6	March 28, 2005
10.31.1	September 27, 2004	11.20.7	September 30, 2002
10.31.2	March 28, 2005	11.20.8-9	September 27, 2004
10.31.3	September 26, 2003	11.20.10	March 28, 2005
10.31.4	March 28, 2005	11.30.1	September 30, 2002
10.31.5	September 27, 2004	11.30.2	March 28, 2005
10.31.6	September 26, 2003	11.30.3-4	September 30, 2002
10.40.1-10	March 28, 2005	11.31.1-7	February 13, 2004
* 10.40.11	September 29, 2005	11.31.8	March 28, 2005
10.40.12-13	March 28, 2005	11.31.9-12	February 13, 2004
* 10.40.14	September 29, 2005	11.31.13	March 28, 2005
10.40.15-16	March 28, 2005	11.31.14-15	September 27, 2004
10.41.1	September 27, 2004	11.31.16	March 28, 2005
10.41.2-11	March 28, 2005	11.31.17-19	September 27, 2004
* 10.41.12	September 29, 2005	11.31.20	March 28, 2005
10.41.13-14	March 28, 2005	11.31.21	September 27, 2004
* 10.41.15	September 29, 2005	* 11.31.22-34	September 29, 2005
10.41.16	March 28, 2005	* 11.31.35-36	Deleted
11 Flight Management, Navigation (tab)		11.32.1	September 30, 2002
* 11.TOC.0.1-8	September 29, 2005	* 11.32.2	September 29, 2005
11.10.1	February 13, 2004	11.32.3-6	September 30, 2002
11.10.2	March 28, 2005	11.33.1-12	February 13, 2004
11.10.3-4	February 13, 2004		

* = Revised, Added, or Deleted



737 Flight Crew Operations Manual

Page	Date	Page	Date
11 Flight Management, Navigation (cont)		11 Flight Management, Navigation (cont)	
11.40.1-5	February 13, 2004	* 11.43.4-32	September 29, 2005
11.40.6	March 28, 2005	* 11.43.33-34	Deleted
11.40.7	September 27, 2004	11.60.1	February 13, 2004
11.40.8-14	February 13, 2004	11.60.2-4	September 27, 2004
11.40.15	March 28, 2005	11.60.5-9	March 28, 2005
11.40.16-25	February 13, 2004	* 11.60.10	September 29, 2005
11.40.26	March 28, 2005	11.60.11-13	September 27, 2004
11.40.27-35	February 13, 2004	11.60.14	March 28, 2005
11.40.36	March 28, 2005	11.60.15	September 27, 2004
11.40.37-38	February 13, 2004	11.60.16-17	March 28, 2005
11.40.39	March 28, 2005	11.60.18-24	September 27, 2004
* 11.40.40	September 29, 2005	12 Fuel (tab)	
11.40.41	March 28, 2005	12.TOC.0.1-2	February 13, 2004
11.40.42-44	September 27, 2004	12.10.1	September 30, 2002
11.41.1-3	February 13, 2004	12.10.2	March 28, 2005
11.41.4	September 27, 2004	* 12.10.3	September 29, 2005
11.41.5-19	February 13, 2004	12.10.4	September 27, 2004
11.41.20	September 27, 2004	12.10.5	February 13, 2004
11.41.21	March 28, 2005	* 12.10.6	September 29, 2005
11.41.22	February 13, 2004	12.10.7	March 28, 2005
11.41.23	March 28, 2005	12.10.8-10	February 13, 2004
11.41.24-26	February 13, 2004	12.20.1-2	March 28, 2005
* 11.41.27-28	September 29, 2005	12.20.3-4	September 30, 2002
11.41.29-30	February 13, 2004		
11.42.1	February 13, 2004		
11.42.2-8	September 27, 2004		
11.42.9-42	March 28, 2005		
11.43.1	February 13, 2004		
11.43.2-3	March 28, 2005		

* = Revised, Added, or Deleted

Copyright © The Boeing Company. See title page for details.

Page	Date
13 Hydraulics (tab)	
13.TOC.0.1-2	September 26, 2003
13.10.1	September 30, 2002
13.10.2	February 13, 2004
13.10.3	September 27, 2004
13.10.4	September 26, 2003
13.10.5-6	February 13, 2004
13.20.1-3	September 30, 2002
13.20.4-5	February 13, 2004
13.20.6	September 30, 2002
13.20.7	February 13, 2004
13.20.8	September 30, 2002
14 Landing Gear (tab)	
* 14.TOC.0.1-2	September 29, 2005
14.10.1-8	September 30, 2002
14.20.1-3	September 30, 2002
* 14.20.4-8	September 29, 2005
15 Warning Systems (tab)	
* 15.TOC.0.1-2	September 29, 2005
15.10.1-3	September 30, 2002
* 15.10.4-14	September 29, 2005
15.20.1	September 30, 2002
15.20.2	September 27, 2004
* 15.20.3	September 29, 2005
15.20.4	September 27, 2004
15.20.5	March 28, 2005
15.20.6-7	September 30, 2002
* 15.20.8-22	September 29, 2005
* 15.20.23-24	Deleted
(blank tab)	

* = Revised, Added, or Deleted



737 Flight Crew Operations Manual

Page	Date
Quick Reference Handbook	
Quick Action Index	
* QA.Index.1-2	September 29, 2005
Annunciated Index (tab)	
* ANN.Index.1-4	September 29, 2005
Normal Checklists (tab)	
NC.1-4	March 28, 2005
Checklist Introduction (tab)	
CI.TOC.0.1-2	March 28, 2005
CI.1.1-2	March 28, 2005
CI.2.1-3	March 28, 2005
* CI.2.4	September 29, 2005
Non-Normal Checklists (tab)	
0 Unannunciated Checklists (tab)	
* TOC.0.1-2	September 29, 2005
0.1	March 28, 2005
* 0.2-9	September 29, 2005
0.10-11	March 28, 2005
* 0.12	September 29, 2005
0.13	March 28, 2005
* 0.14-15	September 29, 2005
0.16-17	March 28, 2005
* 0.18-20	September 29, 2005
0.21-23	March 28, 2005
* 0.24-31	September 29, 2005
0.32	March 28, 2005
* 0.33-38	September 29, 2005

Page	Date
1 Airplane General, Emergency Equipment, Doors, Windows (tab)	
* TOC.1.1-2	September 29, 2005
1.1	March 28, 2005
* 1.2-10	September 29, 2005
2 Air Systems (tab)	
TOC.2.1-2	March 28, 2005
2.1-6	March 28, 2005
* 2.7-8	September 29, 2005
2.9	March 28, 2005
* 2.10-13	September 29, 2005
2.14-16	March 28, 2005
3 Anti-Ice, Rain (tab)	
TOC.3.1-2	March 28, 2005
* 3.1	September 29, 2005
3.2-4	March 28, 2005
4 Automatic Flight (tab)	
TOC.4.1-2	March 28, 2005
4.1-2	March 28, 2005
5 Communications, Datalink (tab)	
TOC.5.1-2	March 28, 2005
5.1-2	March 28, 2005
6 Electrical (tab)	
TOC.6.1-2	March 28, 2005
6.1	March 28, 2005
* 6.2-3	September 29, 2005
6.4-6	March 28, 2005
7 Engines, APU (tab)	
* TOC.7.1-2	September 29, 2005
7.1	March 28, 2005
* 7.2-8	September 29, 2005

* = Revised, Added, or Deleted

Copyright © The Boeing Company. See title page for details.



737 Flight Crew Operations Manual

Page	Date	Page	Date
7 Engines, APU (cont)		11 Flight Management, Navigation (tab)	
7.9-11	March 28, 2005	* TOC.11.1-2	September 29, 2005
* 7.12-13	September 29, 2005	11.1	March 28, 2005
7.14-15	March 28, 2005	* 11.2-3	September 29, 2005
* 7.16	September 29, 2005	11.4-6	March 28, 2005
7.17	March 28, 2005	12 Fuel (tab)	
* 7.18-19	September 29, 2005	* TOC.12.1-2	September 29, 2005
7.20-26	March 28, 2005	12.1-4	March 28, 2005
* 7.27	September 29, 2005	* 12.5-9	September 29, 2005
7.28	March 28, 2005	12.10	March 28, 2005
8 Fire Protection (tab)		13 Hydraulics (tab)	
TOC.8.1-2	March 28, 2005	TOC.13.1-2	March 28, 2005
8.1-2	March 28, 2005	13.1-3	March 28, 2005
* 8.3	September 29, 2005	* 13.4-5	September 29, 2005
8.4-5	March 28, 2005	13.6-12	March 28, 2005
* 8.6-7	September 29, 2005	14 Landing Gear (tab)	
8.8	March 28, 2005	* TOC.14.1-2	September 29, 2005
* 8.9	September 29, 2005	* 14.1-3	September 29, 2005
8.10-12	March 28, 2005	14.4-6	March 28, 2005
9 Flight Controls (tab)		* 14.7	September 29, 2005
* TOC.9.1-2	September 29, 2005	14.8	March 28, 2005
9.1-2	March 28, 2005	15 Warning Systems (tab)	
* 9.3-4	September 29, 2005	TOC.15.1-2	March 28, 2005
9.5	March 28, 2005	15.1-2	March 28, 2005
* 9.6-28	September 29, 2005	Maneuvers (tab)	
* 9.29-30	Deleted	* MAN.TOC.0.1-2	September 29, 2005
10 Flight Instruments, Display (tab)		MAN.1.1-14	March 28, 2005
TOC.10.1-2	March 28, 2005	MAN.2.1	March 28, 2005
10.1	March 28, 2005	* MAN.2.2-8	September 29, 2005
* 10.2-3	September 29, 2005	* MAN.2.9-10	Deleted
10.4	March 28, 2005		

* = Revised, Added, or Deleted



737 Flight Crew Operations Manual

Page	Date	Page	Date
Performance - Inflight (tab)		Performance - Inflight (cont)	
PI.TOC.0.1-8	September 27, 2004	* PI.22.3	September 29, 2005
PI.10.1-3	February 13, 2004	PI.22.4	March 28, 2005
* PI.10.4	September 29, 2005	PI.22.5	September 27, 2004
PI.10.5-25	February 13, 2004	PI.22.6	March 28, 2005
PI.10.26-27	September 27, 2004	PI.22.7	September 27, 2004
PI.10.28-30	February 13, 2004	PI.22.8-10	March 28, 2005
PI.11.1-8	February 13, 2004	PI.22.11-14	September 27, 2004
* PI.12.1	September 29, 2005	PI.23.1-12	February 13, 2004
PI.12.2	September 27, 2004	PI.24.1	September 27, 2004
* PI.12.3-4	September 29, 2005	PI.24.2-6	February 13, 2004
PI.12.5	September 27, 2004	PI.25.1-4	February 13, 2004
PI.12.6	March 28, 2005	PI.26.1-2	February 13, 2004
PI.12.7	September 27, 2004	PI.26.3-12	September 27, 2004
PI.12.8	March 28, 2005	PI.30.1-3	March 28, 2005
PI.12.9	September 27, 2004	* PI.30.4	September 29, 2005
PI.12.10	March 28, 2005	PI.30.5	February 13, 2004
PI.12.11-14	September 27, 2004	PI.30.6-13	September 27, 2004
PI.13.1-10	February 13, 2004	PI.30.14	March 28, 2005
PI.14.1-4	February 13, 2004	* PI.30.15	September 29, 2005
PI.15.1-4	February 13, 2004	PI.30.16	March 28, 2005
PI.16.1-2	February 13, 2004	PI.30.17-26	September 27, 2004
PI.16.3-12	September 27, 2004	PI.30.27-29	March 28, 2005
PI.20.1-3	February 13, 2004	PI.30.30-40	September 27, 2004
* PI.20.4	September 29, 2005	PI.30.41-42	March 28, 2005
PI.20.5-33	September 27, 2004	PI.31.1-8	February 13, 2004
PI.20.34-35	March 28, 2005	* PI.32.1	September 29, 2005
PI.20.36	September 27, 2004	PI.32.2	September 27, 2004
PI.21.1-8	February 13, 2004	* PI.32.3	September 29, 2005
* PI.22.1	September 29, 2005	PI.32.4	March 28, 2005
PI.22.2	September 27, 2004	PI.32.5	September 27, 2004

* = Revised, Added, or Deleted

Copyright © The Boeing Company. See title page for details.



737 Flight Crew Operations Manual

Page	Date
Performance - Inflight (cont)	
PI.32.6	March 28, 2005
PI.32.7	September 27, 2004
PI.32.8	March 28, 2005
PI.32.9	September 27, 2004
PI.32.10	March 28, 2005
PI.32.11-14	September 27, 2004
PI.33.1-12	February 13, 2004
PI.34.1-2	February 13, 2004
PI.35.1-4	February 13, 2004
PI.36.1-4	February 13, 2004
PI.37.1-2	February 13, 2004
PI.37.3	September 27, 2004
PI.37.4-7	February 13, 2004
PI.37.8	September 27, 2004
PI.37.9-10	February 13, 2004
PI.37.11-12	March 28, 2005
PI.37.13	September 27, 2004
PI.37.14	February 13, 2004
Index (tab)	
* NNC.Index.1-6	September 29, 2005
* NNM.TOC.0.1-2	Deleted
* NNM.1.1-14	Deleted
* NNM.2.1-6	Deleted
Evacuation Checklist (tab)	
* Back Cover.1-2	September 29, 2005

* = Revised, Added, or Deleted



General

The Boeing Company issues Flight Crew Operations Manual (FCOM) bulletins as required. Bulletins transmit temporary information which must be issued before the next formal revision to the FCOM or information of interest to all operators.

Bulletins are numbered sequentially for each operator. Each new bulletin is recorded in this record when received and filed as instructed. A bulletin may not apply to all airplane models. Each bulletin specifically identifies the airplane effectivity. When appropriate, the next formal FCOM revision will include an updated bulletin record page.

Temporary information is normally incorporated into the manual at the next formal revision. When the condition remains temporary after a bulletin incorporation, the temporary paragraphs are identified by a heading referencing the originating bulletin. When the temporary condition no longer exists, the bulletin is cancelled and the original manual content is restored.

Bulletin status is defined as follows:

- In Effect (IE) - the bulletin contains pertinent information not otherwise covered in the FCOM. The bulletin is active and should be retained in the manual.
- Incorporated (INC) - the bulletin operating information has been incorporated into the FCOM. The bulletin is active and should be retained in the manual.
- Cancelled (CANC) - the bulletin is no longer in active and should be removed from the FCOM. Previously cancelled bulletins are no longer listed in the Bulletin Record.

The record below should be accomplished by the person revising the material.

Number	Subject	Date	Status
HGA-1R1	Inflight Start EGT Display	Jun 30, 2004	IE
HGA-4R1	Integrated Standby Flight Display (ISFD) Alignment Anomaly	Jul 14, 2004	IE
HGA-5R2	AD 2002-19-52 and AD 2002-24-51, Center Tank Fuel Pumps	Jul 7, 2003	IE
HGA-8R1	Flight Director and Autopilot Mode Entry Failures	Nov 1, 2004	IE
HGA-10R1	Autopilot Altitude Acquire/Altitude Capture Anomaly	Nov 1, 2004	IE



Flight Crew Operations Manual Bulletin
for
MALEV Hungarian Airlines
(Magyar Legikozlekedesi Vallalat)

The Boeing Company
Seattle, Washington 98124-2207



737

Number: HGA-1 R1

Date: June 30, 2004

Document Effectivity: D6-27370-7Q8-HGA

Subject: Inflight Start EGT Display

Reason: To inform flight crews that the inflight start EGT start limit and exceedance indications may not appear correctly below 20,000 feet. The purpose of this reissue is to provide Service Bulletin information.

Information in this Flight Crew Operations Manual (FCOM) bulletin is recommended by The Boeing Company, but may not be FAA approved at the time of writing. In the event of conflict with the FAA approved Airplane Flight Manual (AFM), the AFM shall supersede. The Boeing Company regards the information or procedures described herein as having a direct or indirect bearing on the safe operation of this model airplane.

THE FOLLOWING PROCEDURE AND/OR INFORMATION IS EFFECTIVE UPON RECEIPT

Background Information

Exhaust Gas Temperature (EGT) is normally displayed on the center instrument panel upper display unit (DU) as both a digital readout and a round dial/moving pointer indication.

The EGT Start Limit redline is displayed during engine start when N2 is less than idle. If an exceedance is noted by the electronic engine control (EEC), the digital readout, box, pointer and indicator change color to red.

Flight testing has shown that the Exhaust Gas Temperature (EGT) Start Limit redline and associated exceedance indications may not display during inflight engine starts below 20,000 feet due to an EEC software error. An EEC software update, due early first quarter 2002, will correct the anomaly.

Operating Instructions

Monitor EGT when performing the Inflight Engine Start procedure to ensure EGT does not exceed the start limit of 725°C during the start attempt.

Administrative Information

Insert this bulletin behind the FCOM Bulletin Record Page in Volume 1 of your FCOM. Amend the FCOM Bulletin Record Page to show Bulletin HGA-1 R1 "IN EFFECT" (IE)

This bulletin replaces bulletin HGA-1, dated September 30, 2002. Discard bulletin HGA-1. Revise the Bulletin Record to show HGA-1 as "CANCELLED" (CANC).

This bulletin will be cancelled after Boeing is notified that all affected airplanes in your fleet have been modified by CFM 56-7B Service Bulletin 73-0082.

Please send all correspondence regarding FCOM bulletin status to one of the following addresses:

Mailing Address: Manager 737, Flight Technical Integration & Data
Boeing Commercial Airplane Group
P. O. Box 3707 MS 20-89
Seattle, WA 98124-2207
USA

Fax Number: (206) 662-7812
Telex: 329430 Station 627
SITA: LKEB07X
E-MAIL: FTID@Boeing.com



Flight Crew Operations Manual Bulletin
for
MALEV Hungarian Airlines
(Magyar Legikozlekedesi Vallalat)

The Boeing Company
Seattle, Washington 98124-2207



737

Number: HGA-4 R1

Date: July 14, 2004

Document Effectivity: D6-27370-7Q8-HGA

Subject: Integrated Standby Flight Display (ISFD) Alignment Anomaly

Reason: To inform flight crews of an ISFD anomaly and provide corrective action. The purpose of this reissue is to provide Service Bulletin information.

Information in this Flight Crew Operations Manual (FCOM) bulletin is recommended by The Boeing Company, but may not be FAA approved at the time of writing. In the event of conflict with the FAA approved Airplane Flight Manual (AFM), the AFM shall supersede. The Boeing Company regards the information or procedures described herein as having a direct or indirect bearing on the safe operation of this model airplane.

THE FOLLOWING PROCEDURE AND/OR INFORMATION IS EFFECTIVE UPON RECEIPT

Background Information

Boeing has received reports of incorrect attitude on the Integrated Standby Flight Display (ISFD). Subsequent investigation has found that improper alignment of the ISFD can cause attitude display anomalies. The display anomaly shows after takeoff as an obvious error in pitch and/or roll.

The Integrated Standby Flight Display (ISFD) performs a two-minute alignment immediately after the Battery switch has been positioned ON. Any change in airplane position during this alignment period may result in inaccurate attitude information not annunciated to the flight crew. The anomaly is not detectable by ISFD internal monitoring and may not show an obvious error in roll and/or pitch indications when compared to the pilots' primary flight instruments during preflight. Gust effects or movement of cabin occupants during the ISFD alignment period will not cause the anomaly.

Re-alignment can only be accomplished by cycling electrical power to the ISFD while the airplane is on the ground. This can be accomplished by removing all airplane electrical power or by an approved maintenance procedure.

The RST switch on the ISFD does not correct for inaccuracies introduced by airplane movement during the alignment process. It should only be pushed in response to the ATT:RST amber message.

Operating Instructions

An airplane Flight Manual (AFM) Limitation will be published that states:

INTEGRATED STANDBY FLIGHT DISPLAY (IF INSTALLED)

The Flight Crew must verify the airplane was not moved during Integrated Standby Flight Display alignment. If unable to verify, then the power up alignment process must be reinitialized and completed prior to flight.”

To comply with the AFM limitation, the airline must have procedures in place to assure flight crews on the first flight of the day, crew change, or after any complete airplane power down, that ISFD alignment was completed before the airplane was moved.

The following note will be added to the Flight Deck Safety Inspection – Captain or First Officer normal procedure:

Battery SwitchON
Guard – Down

Note: Do not move the airplane until ISFD alignment is complete.

The following will be included in the Flight Deck Preparation – Captain normal procedure:

Integrated Standby Flight DisplayCheck
Approach Mode Display – Blank
Set local altimeter setting
Verify flight instrument indications are correct
Verify no flags or messages are displayed.

Administrative Information

This bulletin replaces bulletin HGA-4, dated October 01, 2002. Discard bulletin HGA-4. Revise the Bulletin Record to show HGA-4 as "CANCELLED" (CANC).

Insert this bulletin behind the FCOM Bulletin Record Page in Volume 1 of your FCOM. Amend the FCOM Bulletin Record Page to show Bulletin HGA-4 R1 "IN EFFECT" (IE).

This bulletin will be canceled after Boeing is notified that all affected airplanes in your fleet have been modified by Service Bulletin 737-34-1720.

Please send all correspondence regarding FCOM bulletin status to one of the following addresses:

Mailing Address: Manager 737, Flight Technical Integration & Data
Boeing Commercial Airplane Group
P. O. Box 3707 MS 20-89
Seattle, WA 98124-2207
USA

Fax Number: (206) 662-7812
Telex: 329430 Station 627
SITA: LKEBO7X
E-MAIL: FlightTraining@Boeing.com

Intentionally
Blank



Flight Crew Operations Manual Bulletin
for
MALEV Hungarian Airlines
(Magyar Legikozlekedesi Vallalat)

The Boeing Company
Seattle, Washington 98124-2207



737

Number: HGA-5 R2

Date: July 07, 2003

Document Effectivity: D6-27370-7Q8-HGA

Subject: AD 2002-19-52 and AD 2002-24-51, Center Tank Fuel Pumps

Reason: This is a reissue of HGA-5 R1, issued on November 25, 2002, that informed flight crews of the potential for fuel pump damage that could create a potential ignition source. This reissue provides procedures approved by the FAA per FAA Approval Letters 140S-02-376, 140S-02-363 and 140S-03-189 as an Alternative Method of Compliance.

Information in this Flight Crew Operations Manual (FCOM) bulletin is recommended by The Boeing Company, but may not be FAA approved at the time of writing. In the event of conflict with the FAA approved Airplane Flight Manual (AFM), the AFM shall supersede. The Boeing Company regards the information or procedures described herein as having a direct or indirect bearing on the safe operation of this model airplane.

THE FOLLOWING PROCEDURE AND/OR INFORMATION IS EFFECTIVE UPON RECEIPT

Background Information

Inspections of Hydro-Aire fuel pumps found evidence of a chafed stator lead wire bundle that may cause the wire to contact the rotor and produce arcing, thus creating a potential ignition source. Inspections of other damaged Hydro-Aire pumps found evidence of localized overheating of parts in the priming and vapor pump section of the fuel pump, possibly due to extended dry running.

Because of these findings, the FAA issued Airworthiness Directive (AD) 2002-19-52 in September 2002 and AD 2002-24-51 in November 2002 to require flight crews to maintain certain minimum fuel levels in the center fuel tanks when operating any Hydro-Aire fuel pump.

The Operating Instructions of this bulletin provide the procedures as required by the two ADs. In response to numerous requests from operators, however, Boeing has also developed procedures that will minimize dry running of the center tank fuel pumps, while reducing the potential for large quantities of fuel remaining in the center tank. These alternate procedures have been approved by the FAA per

Approval Letter 140S-03-189 for those airplanes in which the center tank fuel pumps have been inspected via an approved inspection process to ensure proper wire bundle positioning. These alternate procedures are described in the Alternate Operating Instructions section below. In addition, alternate procedures have been approved per Approval Letters 140S-02-376 and 140S-02-363 to provide relief during ground defueling and fuel transfer and are also presented below.

Per AD 2002-19-52, placards are to be installed on all airplanes with affected pumps installed in the center fuel tank. Once both center tank fuel pumps on an individual airplane have been inspected or replaced, the airplane placard may be removed and the Alternate Operating Instructions contained in this bulletin may be used.

Boeing is revising the Master Caution system logic to illuminate the Master Caution and the FUEL system annunciator lights when either center tank fuel pump experiences low pressure. This will provide a more direct indication of a single pump low pressure state and help minimize unintentional dry running of the center tank fuel pumps. In addition, Boeing is revising the control logic for the center tank fuel pumps to incorporate an automatic shutoff feature to further reduce dry running of the pumps. These updates will be available no later than first quarter 2004 via Boeing service bulletin.

The procedures described below in the Operating Instructions sections of this bulletin remain in effect until the Master Caution system logic change and the center tank fuel pump automatic shutoff feature are incorporated.

Operating Instructions (AD 2002-19-52 and AD 2002-24-51)

These procedures are essentially unchanged from those previously published in accordance with AD 2002-19-52 and AD 2002-24-51. Minor changes have been made for clarification.

NORMAL PROCEDURES

The center tank fuel quantity indication system must be operative to dispatch with fuel in the center fuel tank.

The center tank fuel pump switch(es) must be turned OFF at the first indication of fuel pump low pressure any time during the flight. This includes LOW PRESSURE indications that may occur because of pitch attitude changes.

Takeoff and Initial Climb

Both center tank fuel pump switches must be OFF for takeoff if center tank fuel is less than 5000 pounds (2300 kilograms) with the airplane readied for initial taxi. Both center tank fuel pumps should be repositioned ON above 10,000 feet or after the pitch attitude has been reduced to begin acceleration to a climb speed of 250 knots or greater, if more than 1000 pounds (500 kilograms) remain in the center tank.

Climb and Cruise

Both center tank fuel pump switches must be turned OFF during climb and cruise when the center tank fuel quantity reaches approximately 1000 pounds (500 kilograms). A center tank fuel pump switch must be turned OFF at the first indication of fuel pump low pressure any time during the flight. This includes low pressure indications that may occur as a result of pitch attitude changes.

Descent

Both center tank fuel pump switches must be turned OFF at the beginning of the descent if less than 3000 pounds (1400 kilograms) of fuel remain in the center tank. If an extended period of level flight is required prior to approach and landing, i.e., holding, the center tank fuel pump switch(es) may be re-positioned ON if more than 1000 pounds (500 kilograms) remain in the tank. The fuel pump must be turned OFF at the first indication of pump low pressure.

NON-NORMAL PROCEDURES

CONFIG Indication

The CONFIG indicator will annunciate if center tank fuel exceeds 1600 pounds (800 kilograms) and the center tank fuel pump switches are OFF or are producing low pressure. Do not accomplish the CONFIG non-normal procedure prior to or during takeoff with less than 5000 pounds (2300 kilograms) of fuel in the center tank. Do not accomplish the CONFIG non-normal procedure during descent and landing with less than 3000 pounds (1400 kilograms) of fuel in the center tank.

Pump Failure

If one center tank fuel pump fails with fuel in the center tank, position the failed pump OFF. Open the crossfeed valve to prevent a fuel imbalance. The remaining center tank fuel pump may remain ON until the center tank fuel quantity reaches approximately 1000 pounds (500 kilograms). The center tank fuel pump switch must be turned OFF at the first indication of fuel pump low pressure, i.e., Master Caution and FUEL system annunciator lights illuminated, any time during the flight.

NOTE: The fuel crossfeed valve must be closed for landing.

Fuel LOW Indication

In a low fuel non-normal situation, both center tank fuel pumps may be selected ON and all center tank fuel may be used regardless of the amount of fuel remaining in the tank.

ADDITIONAL INFORMATION

Fuel Loading

For the time period that AD 2002-19-52 and AD 2002-24-51 are in effect, the zero fuel gross weight of the airplane plus the weight of center tank fuel may exceed the maximum zero fuel gross weight by up to 5000 pounds (2300

kilograms) for takeoff, climb and cruise, and up to 3000 pounds (1400 kilograms) for descent and landing, provided the effects of balance (CG) have been considered.

Ground Procedures - Defueling and Fuel Transfer

When defueling center or main wing tanks, monitor the Fuel Pump Low Pressure indication lights and position fuel pumps OFF at the first indication of fuel pump low pressure. Defueling with passengers on board is prohibited.

NOTE: The following defueling and fuel transfer procedures may be used in lieu of the above per FAA Approval Letters 140S-02-376 and 140S-02-363.

Prior to transferring fuel or defueling, conduct a lamp test of the respective fuel pump LOW PRESSURE lights. When transferring fuel or defueling from either the center or main wing tanks, monitor the fuel pump LOW PRESSURE lights and turn the fuel pumps OFF at the first indication of fuel pump low pressure. Fuel may be transferred from tank to tank or the aircraft may be defueled with passengers on board, provided the fuel quantity in the tank from which fuel is being taken is maintained at not less than 2000 pounds (900 kilograms). Deplane all passengers and non-essential crew when defueling or transferring fuel from a tank that has a fuel quantity less than 2000 pounds (900 kilograms). Wait until the process has been completed and the respective fuel pumps turned OFF before reloading non-essential crew and passengers.

Operating Instructions (Alternate Operating Instructions)

These procedures have been approved by the FAA as a Alternative Method of Compliance (AMOC) to AD 2002-24-51 per FAA Approval Letter 140S-03-189. These procedures may be used in lieu of the original procedures for those airplanes in which the center tank fuel pumps have been inspected via an approved inspection process to ensure proper wire bundle positioning.

NORMAL PROCEDURES

The center tank fuel quantity indication system must be operative to dispatch with fuel in the center fuel tank.

The center tank fuel pump switch(es) must be turned OFF at the first indication of fuel pump low pressure any time during the flight. This includes LOW PRESSURE indications that may occur as a result of pitch attitude changes.

Takeoff and Initial Climb

Both center tank fuel pump switches must be OFF for takeoff if center tank fuel is less than 5000 pounds (2300 kilograms) with the airplane readied for initial taxi. Both center tank fuel pumps should be repositioned ON above 10,000 feet or after the pitch attitude has been reduced to begin acceleration to a climb speed of 250 knots or greater, if more than 2000 pounds (950 kilograms) remain in the center tank.

Climb and Cruise

Turn one center tank fuel pump switch OFF during climb or cruise when the center tank fuel quantity reaches approximately 2000 pounds (950 kilograms). Open the crossfeed valve to minimize fuel imbalance. When the Master Caution and FUEL system annunciator lights illuminate, turn the remaining center tank fuel pump switch OFF without delay and close the fuel crossfeed valve. The fuel crossfeed valve must be closed for landing.

Descent

Turn one center tank fuel pump switch OFF at the beginning of the descent if less than 3000 pounds (1400 kilograms) of fuel remain in the center tank. Open the crossfeed valve to minimize fuel imbalance. When the Master Caution and FUEL system annunciator lights illuminate, turn the remaining center tank fuel pump switch OFF without delay and close the fuel crossfeed valve. If an extended period of level flight is required prior to approach and landing, i.e., holding, and fuel remains in the center tank, a single center tank fuel pump switch may be repositioned ON if both fuel pumps were previously turned OFF. The fuel crossfeed valve should be opened to prevent fuel imbalance. At the first indication of pump low pressure, the fuel pump must immediately be turned off and the fuel crossfeed valve must be closed. The fuel crossfeed valve must be closed for landing.

NON-NORMAL PROCEDURES

CONFIG Indication

The CONFIG indicator will annunciate if center tank fuel exceeds 1600 pounds (800 kilograms) and the center tank fuel pump switches are OFF or are producing low pressure. Do not accomplish the CONFIG non-normal procedure prior to or during takeoff with less than 5000 pounds (2300 kilograms) of fuel in the center tank. Do not accomplish the CONFIG non-normal procedure during descent and landing with less than 3000 pounds (1400 kilograms) of fuel in the center tank.

Pump Failure

If one center tank fuel pump fails with fuel in the center tank, turn the failed pump switch OFF. Turn the operational pump ON, if previously turned OFF. Open the fuel crossfeed valve to prevent a fuel imbalance. Turn the remaining center tank fuel pump switch OFF when the Master Caution and FUEL system annunciator lights illuminate and close the fuel crossfeed valve.

NOTE: The fuel crossfeed valve must be closed for landing.

Fuel LOW Indication

In a low fuel non-normal situation, both center tank fuel pumps may be selected ON and all center tank fuel may be used regardless of the amount of fuel remaining in the tank.

ADDITIONAL INFORMATION

Fuel Loading

For the time period that AD 2002-19-52 and AD 2002-24-51 are in effect, the zero fuel gross weight of the airplane plus the weight of center tank fuel may exceed the maximum zero fuel gross weight by up to 5000 pounds (2300 kilograms) for takeoff, climb and cruise, and up to 3000 pounds (1400 kilograms) for descent and landing, provided the effects of balance (CG) have been considered.

Ground Procedures - Defueling and Fuel Transfer

Prior to transferring fuel or defueling, conduct a lamp test of the respective fuel pump LOW PRESSURE lights. When transferring fuel or defueling from either the center or main wing tanks, monitor the fuel pump LOW PRESSURE lights and turn the fuel pumps OFF at the first indication of fuel pump low pressure. Fuel may be transferred from tank to tank or the aircraft may be defueled with passengers on board, provided the fuel quantity in the tank from which fuel is being taken is maintained at not less than 2000 pounds (900 kilograms). Deplane all passengers and non-essential crew when defueling or transferring fuel from a tank that has a fuel quantity less than 2000 pounds (900 kilograms). Wait until the process has been completed and the respective fuel pumps turned OFF before reloading non-essential crew and passengers.

Administrative Information

This bulletin replaces HGA-5 R1, dated November 25, 2002. Discard bulletin HGA-5 R1. Revise the Bulletin Record page to show HGA-5 R1 as "CANCELLED" (CANC).

Insert this bulletin behind the FCOM Bulletin Record Page in Volume 1 of your FCOM. Amend the FCOM Bulletin Record Page to show Bulletin HGA-5 R2 "IN EFFECT" (IE)

This bulletin will be canceled after Boeing is notified that the Master Caution system logic change and the center tank fuel pump automatic shutoff feature are incorporated and the center tank fuel pumps have been inspected via an approved inspection process to ensure proper wire bundle positioning.

Please send all correspondence regarding FCOM bulletin status to one of the following addresses:

Mailing Address: Manager 737, Flight Technical Integration & Data
 Boeing Commercial Airplane Group
 P. O. Box 3707 MS 20-89
 Seattle, WA 98124-2207
 USA

Fax Number: (206) 662-7812
Telex: 329430 Station 627
SITA: LKEBO7X
E-MAIL: FTID@Boeing.com

Intentionally
Blank



Flight Crew Operations Manual Bulletin
for
MALEV Hungarian Airlines
(Magyar Legikozlekedesi Vallalat)

The Boeing Company
Seattle, Washington 98124-2207



737

Number: HGA-8 R1

Date: November 01, 2004

Document Effectivity: D6-27370-7Q8-HGA

Subject: Flight Director and Autopilot Mode Entry Failures

Reason: This bulletin informs flight crews of flight director and autopilot anomalies that may be seen on airplanes equipped with the Collins Enhanced Digital Flight Control System (EDFCS). The purpose of this reissue is to provide Service Bulletin informaton.

Information in this Flight Crew Operations Manual (FCOM) bulletin is recommended by The Boeing Company, but may not be FAA approved at the time of writing. In the event of conflict with the FAA approved Airplane Flight Manual (AFM), the AFM shall supersede. The Boeing Company regards the information or procedures described herein as having a direct or indirect bearing on the safe operation of this model airplane.

THE FOLLOWING PROCEDURE AND/OR INFORMATION IS EFFECTIVE UPON RECEIPT

Background Information

Boeing has received reports of failure of the flight director (F/D) to enter takeoff mode and failure of the autopilot and flight director to enter pitch cruise modes on airplanes equipped with the Collins Enhanced Digital Flight Control System (EDFCS).

In certain scenarios, an error in the Collins FCC software may leave the glide slope engage logic set internally in either FCC without a corresponding G/S flight mode annunciation (FMA) on that side. This will cause the F/D takeoff mode and some autopilot or F/D pitch cruise modes to be inhibited.

This condition may also occur when an autopilot or F/D approach is discontinued using means other than autopilot or F/D go-around.

This anomaly will be corrected in a future FCC software upgrade.

Operating Instructions

Prior to takeoff, turn both flight director (F/D) switches OFF. Cycle F/D A ON then OFF. Cycle F/D B ON then OFF. At the completion of these steps, resume normal AFDS operations. This procedure should be accomplished whether the F/Ds are used for takeoff or not.

If an ILS approach is exited after G/S capture by means other than using the TO/GA switch, turn the autopilot and both F/D switches OFF. Cycle F/D A ON then OFF. Cycle F/D B ON then OFF. At the completion of these steps, resume normal AFDS operations.

Administrative Information

This bulletin replaces bulletin HGA-8, dated April 29, 2003. Discard bulletin HGA-8. Revise the Bulletin Record to show HGA-8 as "CANCELLED" (CANC).

Insert this bulletin behind the FCOM Bulletin Record Page in Volume 1 of your FCOM. Amend the FCOM Bulletin Record Page to show Bulletin HGA-8 R1 "IN EFFECT" (IE).

This bulletin will be canceled after Boeing is notified that all affected airplanes in your fleet have been modified by Service Bulletin 737-22A1164. If you do not plan to modify all your airplanes and would like to have the contents of this bulletin incorporated in your FCOM, please advise Boeing accordingly.

Please send all correspondence regarding FCOM bulletin status to one of the following addresses:

Mailing Address: Manager 737, Flight Technical Integration & Data
Boeing Commercial Airplane Group
P. O. Box 3707 MS 20-89
Seattle, WA 98124-2207
USA

Fax Number: (206) 662-7812
Telex: 329430 Station 627
SITA: LKEBO7X
E-MAIL: FTID@Boeing.com



Flight Crew Operations Manual Bulletin
for
MALEV Hungarian Airlines
(Magyar Legikozlekedesi Vallalat)

The Boeing Company
Seattle, Washington 98124-2207



737

Number: HGA-10 R1

Date: November 01, 2004

Document Effectivity: D6-27370-7Q8-HGA

Subject: Autopilot Altitude Acquire/Altitude Capture Anomaly

Reason: This bulletin informs flight crews of an anomaly reported in the Collins Enhanced Digital Flight Control System (EDFCS). The purpose of this reissue is to provide Service Bulletin information.

Information in this Flight Crew Operations Manual (FCOM) bulletin is recommended by The Boeing Company, but may not be FAA approved at the time of writing. In the event of conflict with the FAA approved Airplane Flight Manual (AFM), the AFM shall supersede. The Boeing Company regards the information or procedures described herein as having a direct or indirect bearing on the safe operation of this model airplane.

THE FOLLOWING PROCEDURE AND/OR INFORMATION IS EFFECTIVE UPON RECEIPT

Background Information

Boeing has received a report of excessive pitch up and speed loss on an airplane equipped with the Collins Enhanced Digital Flight Control System (EDFCS) after selection of a new MCP altitude during an autopilot Altitude Acquire (ALT ACQ) maneuver.

Normally, if a new altitude is selected while in ALT ACQ, the Flight Control Computer (FCC) will automatically transition to vertical speed (V/S), synchronizing to the existing airplane vertical speed. If the selection is made after transition to Altitude Hold (ALT HLD), the FCC will remain in ALT HLD at the previously selected altitude.

It has been determined that if a new altitude selection is made when the FCC is in the final transition between ALT ACQ and ALT HLD (within a 200 msec window), an altitude somewhere between the previously selected MCP altitude and the new MCP altitude will be stored as the reference ALT HLD altitude. The FCC will command a pitch maneuver in the direction of this new altitude. This new pitch command may be excessive and if the autopilot is engaged, may require flight crew intervention to return the airplane to a normal flight path.

This anomaly will be corrected in a future FCC software upgrade.

Operating Instructions

If the MCP altitude is adjusted during ALT ACQ or when ALT HLD is first displayed, monitor autopilot and flight director commands. The autopilot or flight director should transition to V/S or continue to level in ALT HLD at the previously selected altitude. If autopilot or flight director pitch commands are excessive, ensure proper flight path control and select a new pitch mode if required.

Administrative Information

This bulletin replaces bulletin HGA-10, dated June 09, 2003. Discard bulletin HGA-10. Revise the Bulletin Record to show HGA-10 as "CANCELLED" (CANC).

Insert this bulletin behind the FCOM Bulletin Record Page in Volume 1 of your FCOM. Amend the FCOM Bulletin Record Page to show Bulletin HGA-10 R1 "IN EFFECT" (IE).

This bulletin will be canceled after Boeing is notified that all affected airplanes in your fleet have been modified by Service Bulletin 737-22A1164. If you do not plan to modify all your airplanes and would like to have the contents of this bulletin incorporated in your FCOM, please advise Boeing accordingly.

Please send all correspondence regarding FCOM bulletin status to one of the following addresses:

Mailing Address: Manager 737, Flight Technical Integration & Data
 Boeing Commercial Airplane Group
 P. O. Box 3707 MS 20-89
 Seattle, WA 98124-2207
 USA

Fax Number: (206) 662-7812
Telex: 329430 Station 627
SITA: LKEB07X
E-MAIL: FTID@Boeing.com



Flight Crew Operations Manual Bulletin
for
MALEV Hungarian Airlines
(Magyar Legikozlekedesi Vallalat)

The Boeing Company
Seattle, Washington 98124-2207



737

Number: HGA-13 R1

Date: November 01, 2004

Document Effectivity: D6-27370-7Q8-HGA

Subject: Target Speed Anomaly with Flaps Extended and VNAV Engaged

Reason: This bulletin informs flight crews of target speed anomalies on airplanes equipped with the Collins Enhanced Digital Flight Control System (EDFCS) when flaps are extended and operating in VNAV. The purpose of this reissue is to provide Service Bulletin information.

Information in this Flight Crew Operations Manual (FCOM) bulletin is recommended by The Boeing Company, but may not be FAA approved at the time of writing. In the event of conflict with the FAA approved Airplane Flight Manual (AFM), the AFM shall supersede. The Boeing Company regards the information or procedures described herein as having a direct or indirect bearing on the safe operation of this model airplane.

THE FOLLOWING PROCEDURE AND/OR INFORMATION IS EFFECTIVE UPON RECEIPT

Background Information

Boeing has received reports of target speed anomalies with flaps extended when operating in VNAV during approach. The anomaly may occur at any flap setting from Flaps 2 to Flaps 40, but the discrepancy is most likely to occur at Flaps 15 due to system tolerances.

The Flight Management Computer (FMC) uses flap position data as output by the Flight Control Computer (FCC). Due to an implementation error in the Collins Enhanced Digital Flight Controls System (EDFCS), the FCC sends uncorrected flap position data rather than adjusted data. The FMC switches to the next higher flap setting when it receives a signal that the flap position has increased more than 0.5 degrees above the selected flap detent. With the flap handle at Flaps 15, the uncorrected flap position data may be as high as 19.5 degrees depending on airplane installation and tolerances. Similar differences between uncorrected and adjusted data exist for other flap settings, but the system tolerances are much smaller. As a result, the anomaly is less likely to occur at flap settings other than Flaps 15.

When Flaps 15 is selected, the target speed initially indicates the correct airspeed for the flap setting as the flaps transition from 10.5 to 15 degrees. If the tolerances at this flap setting result in an uncorrected output greater than 15.5 degrees, the target speed (magenta bug) may reduce to a speed consistent with Flaps 25 and the autothrottles will adjust to capture this lower speed. This results in the aircraft slowing to near minimum maneuver speed for Flaps 15.

When flying a VNAV approach on airplanes equipped with speed intervention (SPD INTV), the flight crew should select SPD INTV prior to the initial flap selection and manually set the correct flap speed on the MCP. The autothrottles will adjust to capture the MCP speed. SPD INTV should be used for the duration of the approach.

On airplanes without speed intervention, VNAV must be disengaged and the approach flown in another mode if the anomaly is observed. When landing flaps are selected, VNAV may be re-engaged.

On airplanes equipped with the Head-Up Display (HUD), the AOA approach band may not be correctly displayed with Flaps 15 selected. When Flaps 30 or 40 have been selected, the AOA approach band will be correctly displayed on the HUD.

This anomaly will be corrected in a future FCC software upgrade targeted for early 2004.

Operating Instructions

When flying VNAV approaches on airplanes equipped with speed intervention (SPD INTV), select SPD INTV prior to the initial flap selection and manually select the correct speed on the MCP. Remain in SPD INTV for the duration of the approach.

On airplanes without speed intervention, disengage VNAV and fly the approach in another mode if the anomaly is observed. When landing flaps are selected, VNAV may be re-engaged.

On airplanes equipped with HUD, if the AOA approach band is not correctly displayed at Flaps 15, do not use this information.

Administrative Information

This bulletin replaces bulletin HGA-13, dated September 30, 2003. Discard bulletin HGA-13. Revise the Bulletin Record to show HGA-13 as "CANCELLED" (CANC).

Insert this bulletin behind the FCOM Bulletin Record Page in Volume 1 of your FCOM. Amend the FCOM Bulletin Record Page to show Bulletin HGA-13 R1 "IN EFFECT" (IE)

This bulletin will be canceled after Boeing is notified that all affected airplanes in your fleet have been modified by Service Bulletin 737-22A1164. If you do not plan to modify all your airplanes and would like to have the contents of this bulletin incorporated in your FCOM, please advise Boeing accordingly.

Please send all correspondence regarding FCOM bulletin status to one of the following addresses:

Mailing Address: Manager 737, Flight Technical Integration & Data
 Boeing Commercial Airplane Group
 P. O. Box 3707 MS 20-89
 Seattle, WA 98124-2207
 USA

Fax Number: (206) 662-7812
Telex: 329430 Station 627
SITA: LKEBO7X
E-MAIL: FTID@Boeing.com

Intentionally
Blank



Flight Crew Operations Manual Bulletin
for
MALEV Hungarian Airlines
(Magyar Legikozlekedesi Vallalat)

The Boeing Company
Seattle, Washington 98124-2207



737

Number: HGA-15 R2

Date: November 01, 2004

Document Effectivity: D6-27370-7Q8-HGA

Subject: FMC Navigation Anomaly

Reason: This bulletin informs flight crews of an FMC navigation anomaly on airplanes equipped with dual FMCs and FMC Updates U10.3, U10.4, U10.4a or U10.5. The purpose of this reissue is to provide Service Bulletin information.

Information in this Flight Crew Operations Manual (FCOM) bulletin is recommended by The Boeing Company, but may not be FAA approved at the time of writing. In the event of conflict with the FAA approved Airplane Flight Manual (AFM), the AFM shall supersede. The Boeing Company regards the information or procedures described herein as having a direct or indirect bearing on the safe operation of this model airplane.

THE FOLLOWING PROCEDURE AND/OR INFORMATION IS EFFECTIVE UPON RECEIPT

Background Information

Boeing has received reports of FMC map shifts on 737-400 airplanes equipped with dual FMCs and FMC Update U10.4a. The root cause of the problem has not been determined, but Boeing and Smiths Industries believe the anomaly may be possible on all 737 airplanes with dual FMCs and FMC Updates U10.3, U10.4, U10.4a or U10.5. The problem can occur on both GPS and non-GPS equipped airplanes.

Each of the reported map shifts was accompanied by a “VERIFY POSITION” alert message and a displayed ACTUAL navigation performance value that was less than the RNP value. In these events, the “VERIFY POSITION” message indicated an actual FMC position error.

The “VERIFY POSITION” message is triggered by differences in FMC and/or sensor positions and RNP. The “UNABLE REQD NAV PERF - RNP” message is generated when ACTUAL navigation performance does not satisfy the RNP criteria. POS SHIFT page 3/3 provides the relative FMC, GPS (if installed), IRS and RADIO positions, as well as RNP and ACTUAL navigation performance.

For at least one of the reported events, map shifts occurred on both displays due to the FMC position aligning with the average IRS position. Each FMC's internal position then reverted to its inside IRS position. When the FMC positions exceeded the RNP criteria, the "VERIFY POSITION" message was triggered.

The ACTUAL navigation performance computation did not reflect the FMC reversion to inertial only operation. Since the computed ACTUAL navigation performance was based on the available, but unused, radio and GPS position data, it was less than the RNP, and the "UNABLE REQD NAV PERF - RNP" message was not displayed.

If the FMC Source Select Switch is positioned to BOTH ON L or BOTH ON R (i.e., equivalent to single FMC operation), the FMC position is updated from available inside sensors with the correct ACTUAL navigation performance. The "VERIFY POSITION" message will then clear if the resulting FMC position is within the RNP. With the anomaly present, the problem will recur when the FMCs are switched back to NORMAL (dual FMC operation) and the "VERIFY POSITION" message will again be displayed.

Whenever flight crews encounter a "VERIFY POSITION" message, the message should not be manually cleared from the FMC scratchpad. If the message appeared shortly after manually entering an approach RNP of 0.2 NM or less while in cruise, or during descent above 15,000 feet, the message may be due to delays in sensor updating rather than an FMC navigation anomaly. If there is no FMC anomaly, the message will self-clear after the airplane is slowed below approximately 250 knots.

However, an anomaly is indicated if the "VERIFY POSITION" message is displayed during either of the following conditions:

- within 60 seconds after descending through 15,000 feet (terminal navigation environment, default RNP = 1.0 NM), or
- within 10 seconds after passing within two NM of the initial approach fix (approach navigation environment, default RNP = 0.5 NM or with the NPS option, default RNP = 0.3 NM).

In the event of an FMC navigation anomaly, RNAV (RNP) operations should not be conducted while the "VERIFY POSITION" message is displayed. The FMC Source Select Switch should be positioned to BOTH ON L or BOTH ON R to cause the FMC to return to updating from available inside sensors. The FMC Source Select Switch should remain in the selected position for the remainder of the flight to prevent the anomaly from recurring.

After landing, a long-term power interrupt of 15 seconds or longer will be necessary to at least one FMC to clear the anomalies. This can be accomplished by removing all airplane electrical power or by an approved maintenance procedure.

This problem remains under investigation. Boeing and Smiths Industries are evaluating the need for an intermediate FMC Update (U10.5a) that would be targeted for second quarter 2004.

Operating Instructions

If the "VERIFY POSITION" message appears, do not clear the message from the FMC scratchpad. Do not conduct RNAV (RNP) operations while the message is displayed.

If the "VERIFY POSITION" message appears shortly after manually entering an approach RNP of 0.2 NM or less while in cruise or during descent above 15,000 feet, slow the airplane to 250 knots or less. If the message is due to delays in sensor updating the message will self-clear.

If the "VERIFY POSITION" message is displayed when descending through 15,000 feet, or after passing within two NM of the initial approach fix, position the FMC Source Select Switch to BOTH ON L or BOTH ON R for the remainder of the flight.

After landing, a long-term power interrupt (15 seconds or longer) must be performed on at least one FMC to clear the anomalies.

Administrative Information

This bulletin replaces bulletin HGA-15 R1, dated December 15, 2003. Discard bulletin HGA-15 R1. Revise the Bulletin Record to show HGA-15 R1 as "CANCELLED" (CANC).

Insert this bulletin behind the FCOM Bulletin Record Page in Volume 1 of your FCOM. Amend the FCOM Bulletin Record Page to show Bulletin HGA-15 R2 "IN EFFECT" (IE).

This bulletin will be canceled after Boeing is notified that all affected airplanes in your fleet have been modified by Service Bulletin 737-34A1801. If you do not plan to modify all your airplanes and would like to have the contents of this bulletin incorporated in your FCOM, please advise Boeing accordingly.

Please send all correspondence regarding FCOM bulletin status to one of the following addresses:

Mailing Address: Manager 737, Flight Technical Integration & Data
 Boeing Commercial Airplane Group
 P. O. Box 3707 MS 20-89
 Seattle, WA 98124-2207
 USA

Fax Number: (206) 662-7812
Telex: 329430 Station 627
SITA: LKEBO7X
E-MAIL: FTID@Boeing.com



Flight Crew Operations Manual Bulletin
for
MALEV Hungarian Airlines
(Magyar Legikozlekedesi Vallalat)

The Boeing Company
Seattle, Washington 98124-2207



737

Number: HGA-16

Date: January 12, 2004

Document Effectivity: D6-27370-7Q8-HGA

Subject: Flight Director Anomaly

Reason: This bulletin informs flight crews of a Flight Director anomaly during Flight Director Takeoffs on airplanes equipped with the Collins Enhanced Digital Flight Control System (EDFCS).

Information in this Flight Crew Operations Manual (FCOM) bulletin is recommended by The Boeing Company, but may not be FAA approved at the time of writing. In the event of conflict with the FAA approved Airplane Flight Manual (AFM), the AFM shall supersede. The Boeing Company regards the information or procedures described herein as having a direct or indirect bearing on the safe operation of this model airplane.

THE FOLLOWING PROCEDURE AND/OR INFORMATION IS EFFECTIVE UPON RECEIPT

Background Information

Boeing has discovered a flight director anomaly on airplanes equipped with the Collins Enhanced Digital Flight Control System (EDFCS). The anomaly may occur if the TO/GA switch is pressed a second time after liftoff while the flight director is already in takeoff mode. This anomaly only occurs during a flight director takeoff. Go-around mode is not affected, nor is operation with the autopilot engaged.

If LNAV has been selected prior to takeoff and a TO/GA switch has been pushed, pushing a TO/GA switch a second time after liftoff results in loss of flight director roll guidance and roll mode annunciation. Flight director roll guidance will be removed from view on those airplanes equipped with the split axis flight director and both pitch and roll flight director guidance will be removed from view on those airplanes equipped with the integrated cue flight director. This anomaly will occur anytime the airplane is in takeoff mode, regardless of altitude. LNAV or another roll mode can be re-selected anytime above 400 feet AGL and the correct flight director information will be displayed.

In addition, on those airplanes with the Heading Select-on-Takeoff option, pushing a TO/GA switch a second time while in Takeoff Heading Select mode

above 400 feet AGL, will also result in loss of flight director roll guidance and roll mode annunciation. The flight director bar(s) will be removed from view. The correct flight director information will be displayed after re-selecting a roll mode.

This anomaly is present on all airplanes equipped with the Collins EDFCS, regardless of software load (i.e., P1.1 or P2.0). It will be corrected in a future FCC software upgrade targeted for first quarter 2005.

Operating Instructions

If roll mode annunciation and flight director guidance (roll, or pitch and roll) is lost following a second push of a TO/GA switch, reselect the appropriate roll mode when above 400 feet AGL.

Administrative Information

Insert this bulletin behind the FCOM Bulletin Record Page in Volume 1 of your FCOM. Amend the FCOM Bulletin Record Page to show Bulletin HGA-16 "IN EFFECT" (IE)

This condition is temporary until the system is modified. This FCOM bulletin will be revised to include Service Bulletin information when available.

Please send all correspondence regarding FCOM bulletin status to one of the following addresses:

Mailing Address: Manager 737, Flight Technical Integration & Data
 Boeing Commercial Airplane Group
 P. O. Box 3707 MS 20-89
 Seattle, WA 98124-2207
 USA

Fax Number: (206) 662-7812
Telex: 329430 Station 627
SITA: LKEBO7X
E-MAIL: FlightTraining@Boeing.com



Flight Crew Operations Manual Bulletin for MALEV Hungarian Airlines (Magyar Legikozlekedesi Vallalat)

The Boeing Company
Seattle, Washington 98124-2207



737

Number: HGA-19 R1

Date: November 01, 2004

Document Effectivity: D6-27370-7Q8-HGA

Subject: FMC Arc Leg Sequencing Anomaly

Reason: This bulletin informs flight crews of a problem reported in the U10 series FMC. The purpose of this reissue is to provide Service Bulletin information.

Information in this Flight Crew Operations Manual (FCOM) bulletin is recommended by The Boeing Company, but may not be FAA approved at the time of writing. In the event of conflict with the FAA approved Airplane Flight Manual (AFM), the AFM shall supersede. The Boeing Company regards the information or procedures described herein as having a direct or indirect bearing on the safe operation of this model airplane.

THE FOLLOWING PROCEDURE AND/OR INFORMATION IS EFFECTIVE UPON RECEIPT

Background Information

Boeing has recently discovered a FMC U10 Series problem associated with sequencing waypoints with either DME Arcs to a Fix (AF legs) or Constant Radius to a Fix (RF legs). This problem only can occur if two sequential AF legs are in the route whereas this problem may occur with only one RF leg in the route.

An AF leg or RF leg is used to create an arcing route between waypoints. On the LEGS page, arc legs are identified by title containing the arc distance in nautical miles (7.3) followed by the letter L (left) or R (right), for example 7.3 L or 10.4 R. Examples of sequential DME arcs can be found on Jeppesen charts for KYKM, Yakima Washington USA, 13-1, VOR DME or GPS Rwy 27; MGGT, Guatemala, 11-3, ILS DME Arc Rwy 01; EGBB, Birmingham, UK, 11-1, ILS DME Rwy 15. The recommended method of identifying routes with DME arcs is to use the published charts as well as the FMC LEGS page.

RF legs are only used by a few operators who have tailored navigation databases associated with very low RNP operations.

If this problem occurs, the FMC does not properly sequence the waypoint at the termination of the arc and continues to provide lateral guidance commands to continue flying the arc radius. The route shown on the HSI map is not changed and appears normal but the airplane will begin deviating from the magenta flight

path since lateral guidance continues to follow the arc radius. Lab testing indicates that during this condition, LNAV will remain engaged. If Navigation Performance Scales (NPS) are installed, they provide an erroneous display of flight technical error because lateral deviation is based on continuing to follow the arc rather than the displayed magenta path. This problem has been reported during a non-revenue flight test and during flight simulator testing. Boeing is not aware of any in-service reports of this problem.

A remedy for this problem is planned to be incorporated in the next FMC software update, U10.5A. As a result, we plan to delay the previously scheduled certification date of U10.5A from May 2004 to approximately June 2004.

Operating Instructions

Boeing recommends that in either IMC or VMC conditions, flight crews monitor routes with DME arcs (AF legs) to insure the airplane follows the published route. Until a remedy has been incorporated, we recommend flight crews not use Constant Radius Arcs (RF legs) unless in VMC.

Administrative Information

This bulletin replaces bulletin HGA-19, dated April 12, 2004. Discard bulletin HGA-19. Revise the Bulletin Record to show HGA-19 as "CANCELLED" (CANC).

Insert this bulletin behind the FCOM Bulletin Record Page in Volume 1 of your FCOM. Amend the FCOM Bulletin Record Page to show Bulletin HGA-19 R1 "IN EFFECT" (IE).

This bulletin will be canceled after Boeing is notified that all affected airplanes in your fleet have been modified by Service Bulletin 737-34A1801 which installs FMC Update U10.5A or when Boeing is notified that a later software version has been installed.

Please send all correspondence regarding FCOM bulletin status to one of the following addresses:

Mailing Address: Manager 737, Flight Technical Integration & Data
 Boeing Commercial Airplane Group
 P. O. Box 3707 MS 20-89
 Seattle, WA 98124-2207
 USA

Fax Number: (206) 662-7812
Telex: 329430 Station 627
SITA: LKEBO7X
E-MAIL: FTID@Boeing.com



Flight Crew Operations Manual Bulletin
for
MALEV Hungarian Airlines
(Magyar Legikozlekedesi Vallalat)

The Boeing Company
Seattle, Washington 98124-2207



737

Number: HGA-20

Date: June 04, 2004

Document Effectivity: D6-27370-7Q8-HGA

Subject: Center Tank Fuel System Changes

Reason: This bulletin provides information about center tank fuel system changes for 737-600/-700/-800/-900 airplanes.

Information in this Flight Crew Operations Manual (FCOM) bulletin is recommended by The Boeing Company, but may not be FAA approved at the time of writing. In the event of conflict with the FAA approved Airplane Flight Manual (AFM), the AFM shall supersede. The Boeing Company regards the information or procedures described herein as having a direct or indirect bearing on the safe operation of this model airplane.

THE FOLLOWING PROCEDURE AND/OR INFORMATION IS EFFECTIVE UPON RECEIPT

Background Information

Boeing has introduced center tank fuel system changes in production, at Production Line Number 1494 and on, with deliveries starting in May 2004. These revisions include a Master Caution system logic change, center tank fuel pump auto shutoff and CONFIG alert logic change. These system updates will be available for post-production retrofit via Boeing Service Bulletins no later than fourth quarter 2004.

The Master Caution system logic has been revised so the Master Caution lights and the FUEL system annunciator light illuminate when either center tank fuel pump indicates low pressure, as opposed to the original Master Caution system logic that requires both center tank fuel pumps to indicate low pressure before the Master Caution lights and the FUEL system annunciator light illuminate. As a result of this system logic change, Master Caution light recall will no longer cause the Master Caution and FUEL annunciator lights to illuminate if one center tank fuel pump switch is positioned OFF and the other is positioned ON.

To limit the potential for prolonged dry running of the center tank fuel pumps, a Center Tank Boost Pump Auto Shutoff system has been installed to automatically turn the affected center tank fuel pump off after 15 seconds of continuous low fuel pressure indication. The center tank fuel pump switch will remain in the ON

position and LOW PRESSURE will be illuminated until the flight crew positions the fuel pump switch to OFF. The auto shutoff feature will individually control the center tank fuel pumps and can be manually reset by turning the respective center tank fuel pump switch OFF, then ON. If no fuel is available, the pump will again turn off after 15 seconds of continuous low pressure. This system is intended to be a backup to normal flight crew procedures.

The CONFIG alert logic has been changed so that the alert is illuminated when center tank quantity is greater than 1600 pounds/726 kilograms, either engine is running and both center tank fuel pump switches are positioned OFF.

New Normal Procedures have been developed for airplanes with the center tank fuel system changes installed. These are presented in the Operating Instructions below. However, operators may continue to use the procedures contained in AD 2002-19-52 and AD 2002-24-51, or the procedures approved in FAA Approval Letter 140S-03-189 as an Alternative Method of Compliance (AMOC), until all center tank fuel pumps have been inspected and all airplanes in their fleet have been modified. The AD 2002-19-52 and AD 2002-24-51 procedures, as well as the AMOC procedures, were discussed in detail in the Flight Crew Operations Manual Bulletin titled “AD 2002-19-52 and AD 2002-24-51, Center Tank Fuel Pumps.”

Operating Instructions

Operators must determine which of the three following procedures are to be used for their fleet.

The first two operating procedures were discussed in detail in the Flight Crew Operations Manual Bulletin titled “AD 2002-19-52 and AD 2002-24-51, Center Tank Fuel Pumps.”

Operating Procedure 1 - AD 2002-19-52 and AD 2002-24-51

The procedures contained in AD 2002-19-52 and AD 2002-24-51 require flight crews to maintain certain minimum fuel levels in the center fuel tank when operating any Hydro-Aire fuel pump. These procedures must be used on those airplanes in which the center tank fuel pumps have not been inspected via an approved inspection process to ensure proper wire bundle positioning. These procedures may continue to be used after the center tank fuel pumps have been inspected and after installation of the center tank fuel system changes at the discretion of the operator for the time period AD 2002-19-52 and AD 2002-24-51 are in effect.

Operating Procedure 2 - Alternative Method of Compliance (AMOC) to AD 2002-24-51

FAA Approval Letter 140S-03-189 provides alternate procedures that may be used as an Alternative Method of Compliance (AMOC) to AD 2002-24-51 on those airplanes in which the center tank fuel pumps have been inspected via an approved inspection process. These procedures minimize dry running of the center tank fuel pumps, while reducing the potential for large quantities of fuel remaining in the center tank. The AMOC procedures may continue to be used

after installation of the center tank fuel system changes at the discretion of the operator for the time period AD 2002-24-51 is in effect.

NOTE: When using the AMOC procedures on airplanes with the new Master Caution system logic, Master Caution light recall will not cause the Master Caution lights and FUEL system annunciator light to illuminate if one center tank fuel pump switch is positioned OFF and the other is positioned ON.

NOTE: The fuel crossfeed valve must be closed for takeoff and landing.

Operating Procedure 3 - Normal Procedures (Airplanes with Center Tank Fuel System Changes)

The Normal Procedures presented below may be used on those airplanes in which the center tank fuel pumps have been inspected via an approved inspection process to ensure proper wire bundle positioning (AD 2002-19-52) and in which the center tank fuel system changes have been installed in production or via Boeing service bulletins.

Climb and Cruise Procedure

During climb, position both center tank fuel pump switches OFF when one center tank fuel pump LOW PRESSURE light illuminates.

When established in a level attitude at cruise, if the center tank contains usable fuel and the center tank fuel pump switches are OFF, position the center tank fuel pump switches ON again.

Position both center tank fuel pump switches OFF when the center tank is empty.

Descent and Approach Procedure

During descent, position both center tank fuel pump switches OFF when one center tank fuel pump LOW PRESSURE light illuminates.

If established in level flight for an extended period of time (for example, holding) with usable fuel in the center tank and the center tank fuel pump switches OFF, the center tank fuel pump switches may be positioned ON again.

Position both center tank fuel pump switches OFF when the center tank is empty.

NOTE: After a center tank fuel pump has been automatically shutoff, it can be manually reset by turning the respective center tank fuel pump switch OFF, then ON. If no fuel is available, the pump will again turn off after 15 seconds of continuous low pressure. The center tank fuel pump switch will remain in the ON position and the LOW PRESSURE light will be illuminated until the flight crew positions the fuel pump switch to OFF.

Administrative Information

Insert this bulletin behind the FCOM Bulletin Record Page in Volume 1 of your FCOM. Amend the FCOM Bulletin Record Page to show Bulletin HGA-20 "IN EFFECT" (IE)

This bulletin will be canceled after Boeing is notified that all affected airplanes in your fleet have the center tank fuel system changes incorporated and the center tank fuel pumps inspected via an approved inspection process to ensure proper wire bundle positioning.

Please send all correspondence regarding FCOM bulletin status to one of the following addresses:

Mailing Address: Manager 737, Flight Technical Integration & Data
 Boeing Commercial Airplane Group
 P. O. Box 3707 MS 20-89
 Seattle, WA 98124-2207
 USA

Fax Number: (206) 662-7812
Telex: 329430 Station 627
SITA: LKEBO7X
E-MAIL: FlightTraining@Boeing.com



Flight Crew Operations Manual Bulletin for MALEV Hungarian Airlines (Magyar Legikozlekedesi Vallalat)

The Boeing Company
Seattle, Washington 98124-2207



737

Number: HGA-21 R1

Date: April 15, 2005

Document Effectivity: D6-27370-7Q8-HGA

Subject: Nuisance Stall Warning Stick Shaker Events

Reason: This bulletin provides information about nuisance stall warning stick shaker events experienced on 737-600/700/800/900 airplanes. The purpose of this reissue is to revise the crew action when maneuvering during flap retraction from Flaps 1 to Flaps Up with anti-ice selected ON.

Information in this Flight Crew Operations Manual (FCOM) bulletin is recommended by The Boeing Company, but may not be FAA approved at the time of writing. In the event of conflict with the FAA approved Airplane Flight Manual (AFM), the AFM shall supersede. The Boeing Company regards the information or procedures described herein as having a direct or indirect bearing on the safe operation of this model airplane.

THE FOLLOWING PROCEDURE AND/OR INFORMATION IS EFFECTIVE UPON RECEIPT

Background Information

A nuisance stall warning stick shaker event is one in which the stick shaker activates although the airplane is not near a stall condition. In-service incidents have revealed corners of the operating envelope where turbulence or additional maneuver loads can result in momentary nuisance stick shaker events. Boeing has determined the following flight conditions can lead to nuisance stick shaker events:

1. Encountering moderate to severe turbulence when operating at or near the Maximum Operating Altitude.
2. Maneuvering during flap retraction from Flaps 1 to Flaps Up after takeoff or during a missed approach when Engine Anti-Ice is ON or when Wing Anti-Ice has been selected ON after liftoff.
3. Maneuvering at V₂ speed following an engine failure on takeoff when Wing Anti-Ice has been selected ON after liftoff.

Boeing is investigating design changes to the Stall Management/Yaw Damper (SMYD) computer logic to minimize the frequency of these events.

Operating Instructions

Scenario 1: Moderate to severe turbulence is encountered when operating at or near the Maximum Operating Altitude.

Crew Action:

No change in operations is required. Flight crews should be aware stall warning stick shaker events have occurred in moderate turbulence, particularly when flying near the lower amber band when at or near maximum operating altitudes.

Scenario 2: After takeoff or missed approach, the airplane is maneuvered during flap retraction from Flaps 1 to Flaps Up with Engine Anti-Ice ON or Wing Anti-Ice selected ON after liftoff.

Crew Action:

During flap retraction from Flaps 1 to Flaps Up, limit bank angle to 15 degrees and avoid higher maneuver loading of the aircraft until the Leading Edge Flaps Transit light has extinguished. If a higher bank angle is required during this time, avoid the selection of Flaps 1 to Flaps Up until maneuvering is complete or bank angles are 15 degrees or less.

NOTE: A non-maneuvering segment of approximately 1 nm during all-engine operations or approximately 2.5 nm for an engine-out operation will allow for flaps to be retracted from Flaps 1 to Flaps Up.

Scenario 3: The airplane is maneuvered at V2 speed following an engine failure on takeoff when Wing Anti Ice has been selected ON after liftoff.

Crew Action:

Do not turn Wing Anti-Ice ON until airspeed has increased to at least V2+15 knots.

Administrative Information

This bulletin replaces bulletin HGA-21, dated November 16, 2004. Discard bulletin HGA-21. Revise the Bulletin Record to show HGA-21 as "CANCELLED" (CANC).

Insert this bulletin behind the FCOM Bulletin Record Page in Volume 1 of your FCOM. Amend the FCOM Bulletin Record Page to show Bulletin HGA-21 R1 "IN EFFECT" (IE).

This FCOM bulletin will be revised to include Service Bulletin information when available.

Please send all correspondence regarding FCOM bulletin status to one of the following addresses:

Mailing Address: Manager 737, Flight Technical Integration & Data
Boeing Commercial Airplane Group
P. O. Box 3707 MS 20-89
Seattle, WA 98124-2207
USA

Fax Number: (206) 662-7812
Telex: 329430 Station 627
SITA: LKEBO7X
E-MAIL: FlightTraining@Boeing.com

Intentionally
Blank



Flight Crew Operations Manual Bulletin
for
MALEV Hungarian Airlines
(Magyar Legikozlekedesi Vallalat)

The Boeing Company
Seattle, Washington 98124-2207



737

Number: HGA-23

Date: January 31, 2005

Document Effectivity: D6-27370-7Q8-HGA

Subject: Master Caution System Anomaly

Reason: This bulletin provides information about a Master Caution system anomaly during the Light Test.

Information in this Flight Crew Operations Manual (FCOM) bulletin is recommended by The Boeing Company, but may not be FAA approved at the time of writing. In the event of conflict with the FAA approved Airplane Flight Manual (AFM), the AFM shall supersede. The Boeing Company regards the information or procedures described herein as having a direct or indirect bearing on the safe operation of this model airplane.

THE FOLLOWING PROCEDURE AND/OR INFORMATION IS EFFECTIVE UPON RECEIPT

Background Information

A Master Caution system anomaly has been found on 737-600/700/800/900 airplanes at Production Line Number 1640 and later. These airplanes have provisions for GLS capability and have been equipped with a new Mode Control Unit (MCU).

When the Master LIGHTS switch is moved to the TEST position during the Light Test, all system lights and system annunciators will illuminate correctly. If the Master Caution "PUSH TO RESET" is pressed and released during the test, all system annunciators on the annunciator panel will extinguish, with the exception of the IRS annunciator, and the MASTER CAUTION light will re-illuminate. The MASTER CAUTION light and IRS light will extinguish when the Master LIGHTS switch is moved out of the TEST position.

This anomaly is present on MALEV Hungarian Airlines airplane(s) YA377 and YC207. A fix is being considered for a future update of the MCU.

Administrative Information

Insert this bulletin behind the FCOM Bulletin Record Page in Volume 1 of your FCOM. Amend the FCOM Bulletin Record Page to show Bulletin HGA-23 "IN EFFECT" (IE).

This FCOM bulletin will be revised to include Service Bulletin information when available.

Please send all correspondence regarding FCOM bulletin status to one of the following addresses:

Mailing Address: Manager 737, Flight Technical Integration & Data
 Boeing Commercial Airplane Group
 P. O. Box 3707 MS 20-89
 Seattle, WA 98124-2207
 USA

Fax Number: (206) 662-7812
Telex: 329430 Station 627
SITA: LKEBO7X
E-MAIL: FTID@Boeing.com



Flight Crew Operations Manual Bulletin
for
MALEV Hungarian Airlines
(Magyar Legikozlekedesi Vallalat)

The Boeing Company
Seattle, Washington 98124-2207



737

Number: HGA-24

Date: May 02, 2005

Document Effectivity: D6-27370-7Q8-HGA

Subject: FMC Update 549849-015 U10.6 Prediction Errors

Reason: This bulletin informs flight crews of a potential for erroneous ETA, RTA, fuel remaining and Mach number predictions.

Information in this Flight Crew Operations Manual (FCOM) bulletin is recommended by The Boeing Company, but may not be FAA approved at the time of writing. In the event of conflict with the FAA approved Airplane Flight Manual (AFM), the AFM shall supersede. The Boeing Company regards the information or procedures described herein as having a direct or indirect bearing on the safe operation of this model airplane.

THE FOLLOWING PROCEDURE AND/OR INFORMATION IS EFFECTIVE UPON RECEIPT

Background Information

Smiths Aerospace has discovered an error in the Update 549849-015 U10.6 FMC software. The software incorrectly processes wind data for certain downstream route legs which can result in erroneous values for ETA and fuel remaining for downstream waypoints. This anomaly also affects the ability of the FMC to control to a Required Time of Arrival (RTA) at a downstream waypoint. The error is a function of the entered/sensed wind, leg length, and course change between the incoming leg and outgoing leg for a downstream waypoint.

The 549849-015 U10.6 FMC predictions will be incorrect for leg segments that follow intermediate waypoints with a less than a two degree course change between the incoming and outgoing leg, for non-flyover points. The error will occur for leg segments with less than a ten degree course change for flyover points. This results in the FMC incorrectly applying winds for the particular leg. Depending on the magnitude and direction of the wind and the length and direction of the leg, the error in the ETA can range from nothing at all to more than 40 minutes. Fuel predictions and Mach targets will also be proportionally affected. This anomaly does not occur when there is a greater than two degree course change (ten-degree change for flyover waypoints) between the incoming and outgoing legs.

Flight crews should not use FMC downstream predictions for ETA, RTA, fuel remaining or Mach number target when operating with 549849-015 U10.6 FMC software. All predictions should be verified by conventional methods.

Boeing plans to revise, certify and deliver new 549849-016 U10.6 FMC software. Until that time, Boeing recommends all operators re-install U10.5A FMC software on those airplanes that delivered with 549849-015 U10.6.

Operating Instructions

When operating with 549849-015 U10.6 FMC software, do not use FMC predictions for ETA, RTA, fuel remaining or target Mach number. Verify all predictions by conventional methods.

Administrative Information

Insert this bulletin behind the FCOM Bulletin Record Page in Volume 1 of your FCOM. Amend the FCOM Bulletin Record Page to show Bulletin HGA-24 "IN EFFECT" (IE).

This FCOM bulletin will remain in effect until the new 549849-016 U10.6 FMC software has been delivered and Boeing is informed that it has been installed.

Please send all correspondence regarding FCOM bulletin status to one of the following addresses:

Mailing Address: Manager 737, Flight Technical Integration & Data
 Boeing Commercial Airplane Group
 P. O. Box 3707 MS 20-89
 Seattle, WA 98124-2207
 USA

Fax Number: (206) 662-7812
Telex: 329430 Station 627
SITA: LKEB07X
E-MAIL: FTID@Boeing.com



Operating Limitations L.10.1

- General L.10.1
- Airplane General L.10.1
 - Operational Limitations L.10.1
 - Non-AFM Operational Information L.10.1
 - Weight Limitations L.10.2
- Air Systems L.10.3
 - Pressurization L.10.3
 - Non-AFM Operational Information L.10.3
- Anti-Ice, Rain L.10.3
- Autopilot/Flight Director System L.10.3
- Communications L.10.4
 - Aircraft Communications Addressing and Reporting System L.10.4
- Engines and APU L.10.5
 - Engine Limit Display Markings L.10.5
 - Engine Ignition L.10.5
 - Reverse Thrust L.10.5
 - APU L.10.5
 - Non-AFM Operational Information L.10.5
- Flight Controls L.10.5
- Flight Management, Navigation L.10.6
 - Air Data Inertial Reference Unit (ADIRU) L.10.6
 - QFE Selection L.10.6
 - Look-Ahead Terrain Alerting (GPWS) L.10.6
 - Non-AFM Operational Information L.10.6
- Fuel System L.10.7
- Landing Gear L.10.7



Intentionally
Blank

**General**

This chapter contains Airplane Flight Manual (AFM) limitations and Boeing recommended operating limitations. Limitations that are obvious, shown on displays or placards, or incorporated within an operating procedure are not contained in this chapter.

Airplane General**Operational Limitations**

Runway slope	+/- 2%
Maximum Takeoff and Landing Tailwind Component	10 knots
Maximum speeds	Observe gear and flap placards
Maximum Operating Altitude	41,000 ft
Maximum Takeoff and Landing Altitude	8,400 ft

Maximum flight operating latitude – 82° North and 82° South, except for the region between 80° West and 130° West longitude, the maximum flight operating latitude is 70° North, and the region between 120° East and 160° East longitude, the maximum flight operating latitude is 60° South.

Installation of handle covers on the overwing exits must be verified prior to departure whenever passengers are carried.

Photoluminescent Floor Emergency Lighting must be charged in accordance with approved procedures.

Verify that an operational check of the flight deck door access system has been accomplished according to approved procedures once each flight day.

Non-AFM Operational Information

Note: The following items are not AFM limitations, but are provided for flight crew information.

On revenue flights, the escape slide retention bar (girt bar) must be installed during taxi, takeoff and landing.

The maximum demonstrated takeoff and landing crosswind is 36 knots.

Altitude Display Limits for RVSM Operations

Standby altimeters do not meet altimeter accuracy requirements of RVSM airspace.

The maximum allowable in-flight difference between Captain and First Officer altitude displays for RVSM operations is 200 feet.

The maximum allowable on-the-ground altitude display differences for RVSM operations are:

Field Elevation	Max Difference Between Captain & F/O	Max Difference Between Captain or F/O & Field Elevation
Sea Level to 5,000 feet	50 feet	75 feet
5,001 to 10,000 feet	60 feet	75 feet

Weight Limitations

YE321 - YE326

Weights	Kilograms
Maximum Taxi Weight	60,554
Maximum Takeoff Weight	60,327
Maximum Landing Weight	54,657
Maximum Zero Fuel Weight	51,482

YA371 - YA377

Weights	Kilograms
Maximum Taxi Weight	64,636
Maximum Takeoff Weight	64,410
Maximum Landing Weight	58,059
Maximum Zero Fuel Weight	54,657

737 Flight Crew Operations Manual

YC206, YC207

Weights	Kilograms
Maximum Taxi Weight	73,935
Maximum Takeoff Weight	73,708
Maximum Landing Weight	65,317
Maximum Zero Fuel Weight	61,688

YC201 - YC203

Weights	Kilograms
Maximum Taxi Weight	78,017
Maximum Takeoff Weight	77,791
Maximum Landing Weight	65,317
Maximum Zero Fuel Weight	61,688

Air Systems**Pressurization**

The maximum cabin differential pressure (relief valves) is 9.1 psi.

Non-AFM Operational Information

Note: The following items are not AFM limitations, but are provided for flight crew information.

With engine bleed air switches ON, do not operate the air conditioning packs in HIGH for takeoff, approach or landing.

Anti-Ice, Rain

Engine TAI must be on when icing conditions exist or are anticipated, except during climb and cruise below -40°C SAT.

Autopilot/Flight Director System

Use of aileron trim with the autopilot engaged is prohibited.

Do not engage the autopilot for takeoff below 400 feet AGL.

The autopilot must be disengaged before the airplane descends more than 50 feet below the minimum descent altitude (MDA) unless it is coupled to an ILS glide slope and localizer or in the go-around mode.

YE321 - YE326

The Minimum Use Height (MUH) for single channel autopilot operation is defined as 138 feet AGL.

YA371 - YA377

The Minimum Use Height (MUH) for single channel autopilot operation is defined as 135 feet AGL.

YC201 - YC207

The Minimum Use Height (MUH) for single channel autopilot operation is defined as 158 feet AGL.

Maximum allowable wind speeds, when conducting a dual channel Cat II or Cat III landing predicated on autoland operations, are:

- Headwind 25 knots
- Crosswind 20 knots
- Tailwind 10 knots.

Maximum and minimum glideslope angles are 3.25 degrees and 2.5 degrees respectively.

Autoland capability may only be used with flaps 30 or 40 and both engines operative.

Communications

Flights predicated on the use of the following frequencies (MHz) are prohibited: 29.490, 29.489.

Aircraft Communications Addressing and Reporting System

The ACARS is limited to the transmission and receipt of messages that will not create an unsafe condition if the message is improperly received, such as the following conditions:

- the message or parts of the message are delayed or not received,
- the message is delivered to the wrong recipient, or
- the message content may be frequently corrupted.

However, Pre-Departure Clearance, Digital Automatic Terminal Information Service, Oceanic Clearances, Weight and Balance and Takeoff Data messages can be transmitted and received over ACARS if they are verified per approved operational procedures.

Non-AFM Operational Information

Note: The following items are not AFM limitations, but are provided for flight crew information.

Use the VHF radio connected to the top of fuselage antenna for primary ATC communications on the ground.

Engines and APU

Engine Limit Display Markings

Maximum and minimum limits are red.

Caution limits are amber.

Engine Ignition

Engine ignition must be on for:

- takeoff
- landing
- operation in heavy rain
- anti-ice operation.

Reverse Thrust

Intentional selection of reverse thrust in flight is prohibited.

APU

APU bleed + electrical load: max alt 10,000 ft.

APU bleed: max alt 17,000 ft.

APU electrical load: max alt 41,000 ft.

Non-AFM Operational Information

Note: The following items are not AFM limitations, but are provided for flight crew information.

APU bleed valve must be closed when:

- ground air connected and isolation valve open
- engine no. 1 bleed valve open
- isolation and engine no. 2 bleed valves open.

APU bleed valve may be open during engine start, but avoid engine power above idle.

Flight Controls

Max flap extension altitude is 20,000 ft.

Holding in icing conditions with flaps extended is prohibited.

Do not deploy the speedbrakes in flight at radio altitudes less than 1,000 feet.

In flight, do not extend the SPEED BRAKE lever beyond the FLIGHT DETENT.

Flaps 15 normal landings are prohibited. A Flaps 15 landing may be performed when required by a non-normal procedure.

Avoid rapid and large alternating control inputs, especially in combination with large changes in pitch, roll, or yaw (e.g. large side slip angles) as they may result in structural failure at any speed, including below VA.

Non-AFM Operational Information

Note: The following items are not AFM limitations, but are provided for flight crew information.

Alternate flap duty cycle:

Flap Position	Minutes Off
0 – 15	5
greater than 15	25

Flight Management, Navigation

Air Data Inertial Reference Unit (ADIRU)

ADIRU alignment must not be attempted at latitudes greater than 78 degrees 15 minutes.

QFE Selection

The use of LNAV or VNAV with QFE selected is prohibited.

YA375 - YA377, YC207

A QFE altitude reference for the PFDs must be selected in the FMS whenever QFE is used instead of QNH.

YA375 - YA377, YC207

QFE operations are prohibited if the option for QFE altitude reference selection is not installed in the FMS.

Look-Ahead Terrain Alerting (GPWS)

Do not use the terrain display for navigation.

Do not use the look-ahead terrain alerting and terrain display functions:

- within 15 nm of takeoff, approach or landing at an airport not contained in the GPWS terrain database

Note: Refer to Honeywell Document 060-4267-000 for airports and runways contained in the installed GPWS terrain database.

Non-AFM Operational Information

Note: The following items are not AFM limitations, but are provided for flight crew information.

737 Flight Crew Operations Manual

Do not operate weather radar near fuel spills or within 15 feet of people.

Fuel System

The use of Wide Cut Fuels per Class B of GE Specification D50TF2, JP-4 or Jet B, is prohibited.

Maximum tank fuel temperature: 49°C.

Minimum inflight tank fuel temperature: 3°C above the freezing point of the fuel being used or -43°C, whichever is higher.

Fuel Balance

Lateral imbalance between main tanks 1 and 2 must be scheduled to be zero. Random fuel imbalance must not exceed 453 kgs for taxi, takeoff, flight or landing.

Main tanks 1 and 2 must be full if center tank contains more than 453 kgs.

Landing Gear

Operation with assumed temperature reduced takeoff thrust is not permitted with anti-skid inoperative.

Towbarless towing operations are restricted to tow vehicles that are designed and operated to preclude damage to the airplane steering system or which provide a reliable and unmistakable warning when damage to the steering system may have occurred.

Non-AFM Operational Information

Note: The following items are not AFM limitations, but are provided for flight crew information.

Do not apply brakes until after touchdown.

Intentionally
Blank



Normal Procedures

Chapter NP

Table of Contents

Section 0

Introduction NP.11.1

- General NP.11.1
- Normal Procedures Philosophy and Assumptions NP.11.1
- Configuration Check NP.11.1
- Crew Duties NP.11.2
- Control Display Unit (CDU) Procedures NP.11.3
- Autopilot Flight Director System (AFDS) Procedures NP.11.3
- Preflight and Postflight Scan Flow NP.11.4
- Areas of Responsibility - Captain as Pilot Flying or Taxiing NP.11.5
- Areas of Responsibility - First Officer as Pilot Flying or Taxiing NP.11.6

Amplified Procedures NP.21.1

- Preliminary Preflight Procedure – Captain or First Officer NP.21.1
- CDU Preflight Procedure - Captain and First Officer NP.21.3
- Exterior Inspection NP.21.5
- Preflight Procedure – First Officer NP.21.10
- Preflight Procedure – Captain NP.21.22
- Before Start Procedure NP.21.27
- Pushback or Towing Procedure NP.21.29
- Engine Start Procedure NP.21.30
- Before Taxi Procedure NP.21.31
- Before Takeoff Procedure [AD 2002-19-52 and AD 2002-24-51] NP.21.33
- Before Takeoff Procedure [Alternate Method of Compliance (AMOC) to AD 2002-24-51] NP.21.34

Before Takeoff Procedure [Alternate Method of Compliance (AMOC) to AD 2002-24-51 for Airplanes with Master Caution System Logic Change and Automatic Shutoff]	NP.21.34
Takeoff Procedure	NP.21.35
Takeoff Flap Retraction Speed Schedule	NP.21.37
Climb and Cruise Procedure [AD 2002-19-52 and AD 2002-24-51]	NP.21.38
Climb and Cruise Procedure [Alternate Method of Compliance (AMOC) to AD 2002-24-51]	NP.21.39
Climb and Cruise Procedure [Alternate Method of Compliance (AMOC) to AD 2002-24-51 for Airplanes with Master Caution System Logic Change and Automatic Shutoff]	NP.21.40
Descent Procedure [AD 2002-19-52 and AD 2002-24-51]	NP.21.41
Descent Procedure [Alternate Method of Compliance (AMOC) to AD 2002-24-51]	NP.21.42
Descent Procedure [Alternate Method of Compliance (AMOC) to AD 2002-24-51 for Airplanes with Master Caution System Logic Change and Automatic Shutoff]	NP.21.44
Approach Procedure	NP.21.45
Flap Extension Schedule	NP.21.45
Landing Procedure	NP.21.46
Go-Around and Missed Approach Procedure	NP.21.47
Landing Roll Procedure	NP.21.48
After Landing Procedure	NP.21.48
Shutdown Procedure	NP.21.50
Secure Procedure	NP.21.52



General

This chapter gives:

- an introduction to the normal procedures philosophy and assumptions
- step by step normal procedures

Normal Procedures Philosophy and Assumptions

Normal procedures verify for each phase of flight that:

- the airplane condition is satisfactory
- the flight deck configuration is correct

Normal procedures are done on each flight. Refer to the Supplementary Procedures (SP) chapter for procedures that are done as needed, for example the adverse weather procedures.

Normal procedures are used by a trained flight crew and assume:

- all systems operate normally
- the full use of all automated features (LNAV, VNAV, autoland, autopilot, and autothrottle)

Normal procedures also assume coordination with the ground crew before:

- hydraulic system pressurization, or
- flight control surface movement, or
- airplane movement

Normal procedures do not include steps for flight deck lighting and crew comfort items.

Normal procedures are done by recall and scan flow. The panel illustration in this section shows the scan flow. The scan flow sequence may be changed as needed.

Configuration Check

It is the crew member's responsibility to verify correct system response. Before engine start, use system lights to verify each system's condition or configuration. After engine start, the master caution system alerts the crew to warnings or cautions away from the normal field of view.

If there is an incorrect configuration or response:

- verify that the system controls are set correctly
- check the respective circuit breaker as needed. Maintenance must first determine that it is safe to reset a tripped circuit breaker on the ground
- test the respective system light as needed

Before engine start, use individual system lights to verify the system status. If an individual system light indicates an improper condition:

- check the Dispatch Deviations Procedures Guide (DDPG) or the operator equivalent to decide if the condition has a dispatch effect
- decide if maintenance is needed

If, during or after engine start, a red warning or amber caution light illuminates:

- do the respective non-normal checklist (NNC)
- on the ground, check the DDPG or the operator equivalent

If, during recall, an amber caution illuminates and then extinguishes after a master caution reset:

- check the DDPG or the operator equivalent
 - the respective non-normal checklist is not needed
-

Crew Duties

Preflight and postflight crew duties are divided between the captain and first officer. Phase of flight duties are divided between the Pilot Flying (PF) and the Pilot Monitoring (PM.)

Each crewmember is responsible for moving the controls and switches in their area of responsibility. The Area of Responsibility illustrations in this section show the area of responsibility for both normal and non-normal procedures. Typical panel locations are shown.

The captain may direct actions outside of the crewmember's area of responsibility.

The general PF phase of flight responsibilities are:

- taxiing
- flight path and airspeed control
- airplane configuration
- navigation

The general PM phase of flight responsibilities are:

- checklist reading
- communications
- tasks asked for by the PF

PF and PM duties may change during a flight. For example, the captain could be the PF during taxi but be the PM during takeoff through landing.

Normal procedures show who does a step by crew position (C, F/O, PF, or PM):

- in the procedure title, or
- in the far right column, or
- in the column heading of a table

737 Flight Crew Operations Manual

The mode control panel is the PF's responsibility. When flying manually, the PF directs the PM to make the changes on the mode control panel.

The captain is the final authority for all tasks directed and done.

Control Display Unit (CDU) Procedures

Before taxi, the captain or first officer may make CDU entries. The other pilot must verify the entries.

Make CDU entries before taxi or when stopped, when possible. If CDU entries must be made during taxi, the PM makes the entries. The PF must verify the entries before they are executed.

In flight, the PM usually makes the CDU entries. The PF may also make simple, CDU entries when the workload allows. The pilot making the entries executes the change only after the other pilot verifies the entries.

During high workload times, for example departure or arrival, try to reduce the need for CDU entries. Do this by using the MCP heading, altitude, and speed control modes. The MCP can be easier to use than entering complex route modifications into the CDU.

Autopilot Flight Director System (AFDS) Procedures

The crew must always monitor:

- airplane course
- vertical path
- speed

When selecting a value on the MCP, verify that the respective value changes on the flight instruments, as applicable.

The crew must verify manually selected or automatic AFDS changes. Use the FMA to verify mode changes for the:

- autopilot
- flight director
- autothrottle

During LNAV and VNAV operations, verify all changes to the airplane's:

- course
- vertical path
- thrust
- speed

Announcing changes on the FMA and thrust mode display when they occur is a good CRM practice.

Preflight and Postflight Scan Flow

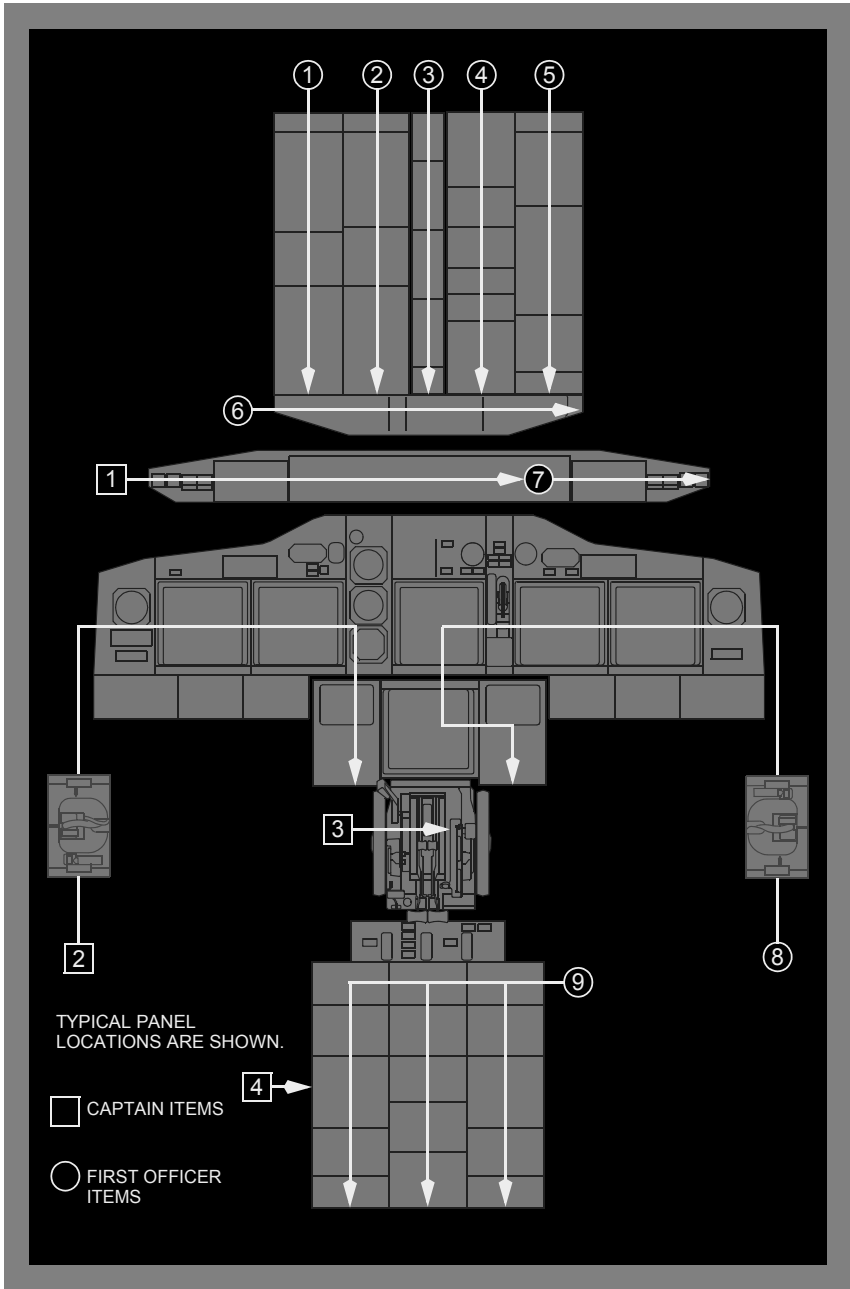

737 Flight Crew Operations Manual

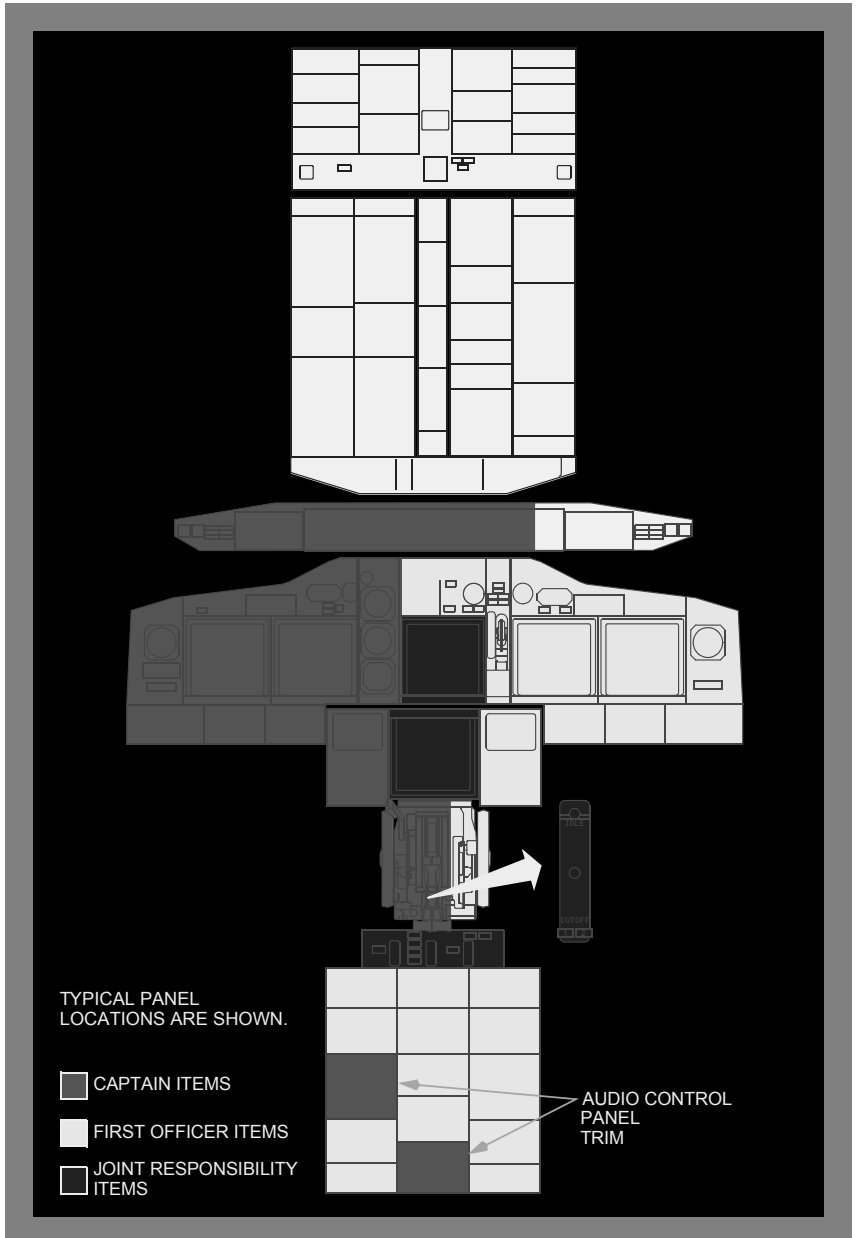
Areas of Responsibility - Captain as Pilot Flying or Taxiing

Areas of Responsibility - First Officer as Pilot Flying or Taxiing

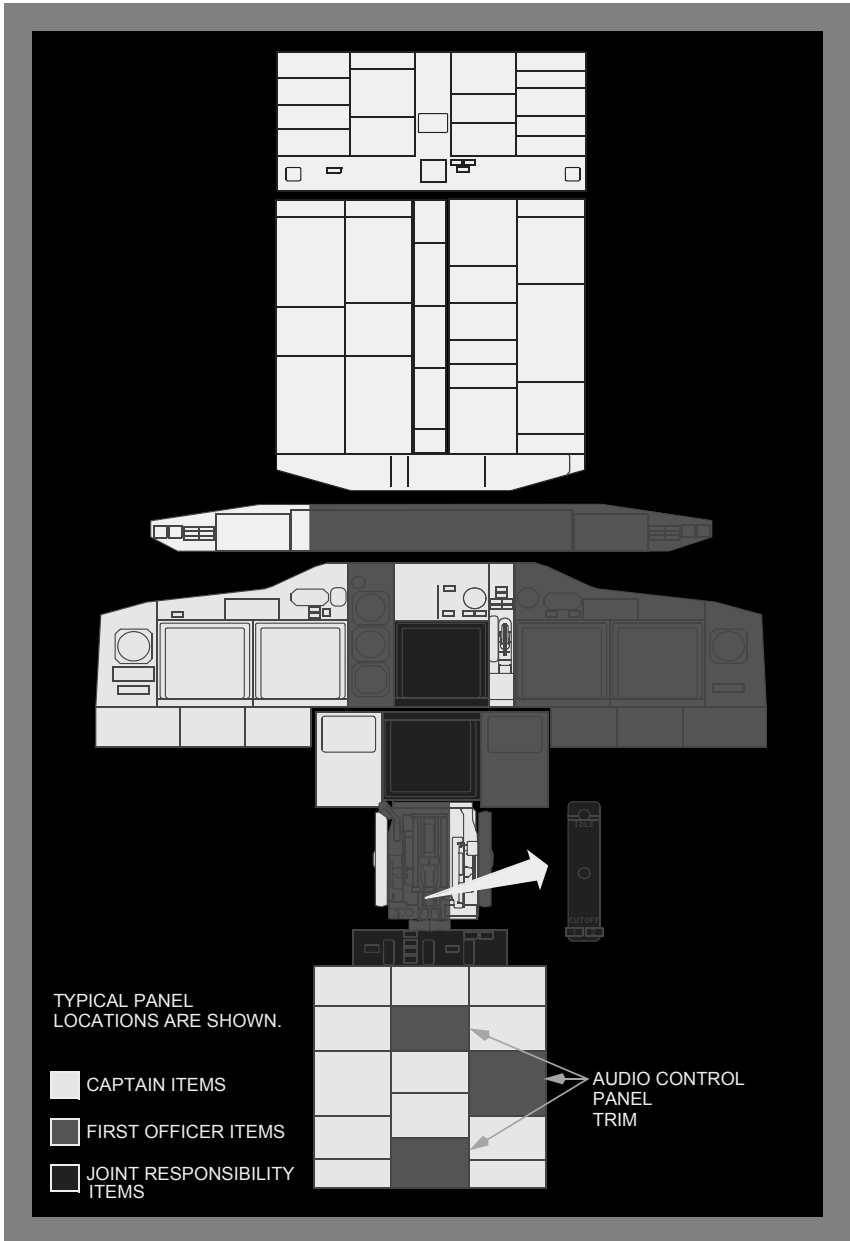



Preliminary Preflight Procedure – Captain or First Officer

The Preliminary Preflight Procedure assumes that the Electrical Power Up supplementary procedure is complete.

A full IRS alignment is recommended before each flight. If time does not allow a full alignment, do the Fast Realignment supplementary procedure.

IRS mode selectorsOFF, then NAV

Verify that the ON DC lights illuminate then extinguish.

Verify that the ALIGN lights are illuminated.

VOICE RECORDER switchAs needed

Verify that the following are sufficient for flight:

- oxygen pressure
- hydraulic quantity
- engine oil quantity

Do the remaining actions after a crew change or maintenance action.

Maintenance documents Check

FLIGHT DECK ACCESS SYSTEM switch Guard closed

Emergency equipment Check

Fire extinguisher – Checked and stowed

Crash axe – Stowed

Escape ropes – Stowed

Other needed equipment – Checked and stowed

PSEU light Verify extinguished

GPS light Verify extinguished

SERVICE INTERPHONE switch OFF

ENGINE panel Set

Verify that the REVERSER lights are extinguished.

Verify that the ENGINE CONTROL lights are extinguished.

EEC switches – ON

Verify that the ALTERNATE lights are extinguished.

Oxygen panel Set

Note: PASSENGER OXYGEN switch activation causes deployment of the passenger oxygen masks.

PASSENGER OXYGEN switch - Guard closed

Verify that the PASS OXY ON light is extinguished.

Verify pressure meets dispatch requirements.

Landing gear indicator lights Verify illuminated

Flight recorder switch Guard closed

Circuit breakers (P6 panel) Check

Manual gear extension access door Closed

Circuit breakers (control stand, P18 panel) Check

Parking brake As needed

Set the parking brake if brake wear indicators will be checked during the exterior inspection.

CDU Preflight Procedure - Captain and First Officer

Start the CDU Preflight Procedure anytime after the Preliminary Preflight Procedure. The Initial Data and Navigation Data entries must be complete before the flight instrument check during the Preflight Procedure. The Performance Data entries must be complete before the Before Start Checklist.

The captain or first officer may make CDU entries. The other pilot must verify the entries.

Enter data in all the boxed items on the following CDU pages.

Enter data in the dashed items or modify small font items that are listed in this procedure. Enter or modify other items at pilot's discretion.

Failure to enter enroute winds can result in flight plan time and fuel burn errors.

Initial DataSet

IDENT page:

Verify that the MODEL is correct.

Verify that the ENG RATING is correct.

Verify that the navigation data base ACTIVE date range is current.

POS INIT page:

Verify that the time is correct.

Enter the present position on the SET IRS POS line. Use the most accurate latitude and longitude.

Navigation DataSet

ROUTE page:

Enter the ORIGIN.

Enter the route.

Enter the FLIGHT NUMBER.

Activate and execute the route.

DEPARTURES page:

Select the runway and departure routing.

Execute the runway and departure routing.

Verify that the ROUTE and LEGS pages are correct.

Performance Data Set

PERF INIT page:

Enter the ZFW.

Verify that the FUEL on the CDU, the dispatch papers, and the fuel quantity indicators agree.

If refueling is not complete, enter the PLAN trip fuel as needed.

Verify that the fuel is sufficient for flight.

Verify that the gross weight and cruise CG (GW/CRZ CG) on the CDU and the dispatch papers agree.

Thrust mode display:

Verify that dashes are shown.

N1 LIMIT page:

Select an assumed temperature, or a fixed derate takeoff, or both as needed.

Select a full or a derated climb thrust as needed.

TAKEOFF REF page:

Make data entries on page 2/2 before page 1/2.

Enter the CG.

Verify that a trim value is shown.

Select or enter the takeoff V speeds.

Verify or enter a thrust reduction altitude.

Verify that the preflight is complete.

Exterior Inspection

Before each flight the captain, first officer, or maintenance crew must verify that the airplane is satisfactory for flight.

Items at each location may be checked in any sequence.

Use the detailed inspection route below to check that:

- the surfaces and structures are clear, not damaged, not missing parts and there are no fluid leaks
- the tires are not too worn, not damaged, and there is no tread separation
- the gear struts are not fully compressed
- the engine inlets and tailpipes are clear, the access panels are secured, the exterior is not damaged, and the reversers are stowed
- the doors and access panels that are not in use are latched
- the probes, vents, and static ports are clear and not damaged
- the skin area adjacent to the pitot probes and static ports is not wrinkled
- the antennas are not damaged
- the light lenses are clean and not damaged

For cold weather operations see the Supplementary Procedures.

Inspection Route

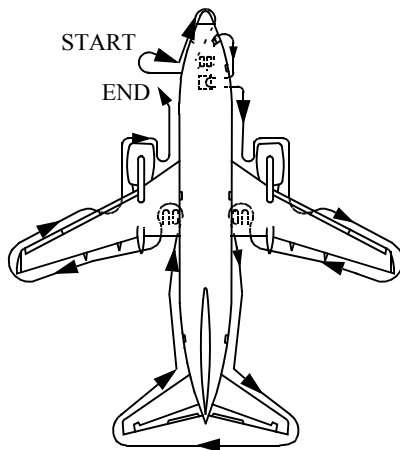

Left Forward Fuselage

Probes, sensors, ports, vents, and drains (as applicable) Check

Doors and access panels (not in use)..... Latched

Nose

Radome Check

Conductor straps - Secure

Forward E and E door Secure

Nose Wheel Well

Tires and wheels Check

Exterior light Check

Gear strut and doors Check

Nose wheel steering assembly Check

Nose gear steering lockout pin As needed

Gear pin As needed

Nose wheel spin brake (snubbers)..... In place

Right Forward Fuselage

Probes, sensors, ports, vents, and drains (as applicable)..... Check

Oxygen pressure relief green disc In place

Doors and access panels (not in use)..... Latched

Right Wing Root, Pack, and Lower Fuselage

Ram air deflector door Extended

Pack and pneumatic access doors Secure

Probes, sensors, ports, vents, and drains (as applicable)..... Check

Exterior lights Check

Leading edge flaps Check

Number 2 Engine

Access panels Latched

737 Flight Crew Operations Manual

Probes, sensors, ports, vents, and drains (as applicable)	Check
Fan blades, probes, and spinner	Check
Thrust reverser	Stowed
Exhaust area and tailcone	Check

Right Wing and Leading Edge

Access panels	Latched
Leading edge flaps and slats	Check
Fuel measuring sticks	Flush and secure
Wing Surfaces	Check
Fuel tank vent	Check

Right Wing Tip and Trailing Edge

Position and strobe lights	Check
Static discharge wicks	Check
Aileron and trailing edge flaps	Check

Right Main Gear

Tires, brakes and wheels	Check
--------------------------------	-------

Verify that the wheel chocks are in place as needed.

If the parking brake is set, the brake wear indicator pins must extend out of the guides.

Gear strut, actuators, and doors	Check
Hydraulic lines	Secure
Gear pin	As needed

Right Main Wheel Well

APU FIRE CONTROL handle	Up
-------------------------------	----

Wheel well Check

Right Aft Fuselage

Doors and access panels (not in use) Latched

Negative pressure relief door Closed

Outflow valve Check

Probes, sensors, ports, vents, and drains (as applicable) Check

APU air inlet Open

Tail

Vertical stabilizer and rudder Check

Elevator feel probes Check

YC201 - YC207

Tail skid Check

Verify that the tail skid is not damaged.

Horizontal stabilizer and elevator Check

Static discharge wicks Check

Strobe light Check

APU cooling air inlet and exhaust outlet Check

Left Aft Fuselage

Doors and access panels (not in use) Latched

Probes, sensors, ports, vents, and drains (as applicable) Check

Left Main Gear

Tires, brakes and wheels Check

Verify that the wheel chocks are in place as needed.

If the parking brake is set, the brake wear indicator pins must extend out of the guides.

Gear strut, actuators, and doors Check

737 Flight Crew Operations Manual

Hydraulic lines Secure
Gear pin As needed

Left Main Wheel Well

Wheel well Check
Engine fire bottle pressure Check

Left Wing Tip and Trailing Edge

Aileron and trailing edge flaps Check
Static discharge wicks Check
Position and strobe lights Check

Left Wing and Leading Edge

Fuel tank vent Check
Wing Surfaces Check
Fuel measuring sticks Flush and secure
Leading edge flaps and slats Check
Access panels Latched

Number 1 Engine

Exhaust area and tailcone Check
Thrust reverser Stowed
Fan blades, probes, and spinner Check
Probes, sensors, ports, vents, and drains (as applicable) Check
Access panels Latched

Left Wing Root, Pack, and Lower Fuselage

Leading edge flaps Check
Probes, sensors, ports, vents, and drains (as applicable) Check
Exterior lights Check

Pack and pneumatic access doors	Secure
Ram air deflector door	Extended

Preflight Procedure – First Officer

The first officer normally does this procedure. The captain may do this procedure as needed.

Flight control panel Check

FLIGHT CONTROL switches – Guards closed

Verify that the flight control LOW PRESSURE lights are illuminated.

Flight SPOILER switches – Guards closed

YAW DAMPER switch – ON

Verify that the YAW DAMPER light is extinguished.

Verify that the standby hydraulic LOW QUANTITY light is extinguished.

Verify that the standby hydraulic LOW PRESSURE light is extinguished.

YA372 - YE326

Verify that the STBY RUD ON light is extinguished.

ALTERNATE FLAPS master switch – Guard closed

ALTERNATE FLAPS position switch – OFF

Verify that the FEEL DIFF PRESS light is extinguished.

Verify that the SPEED TRIM FAIL light is extinguished.

Verify that the MACH TRIM FAIL light is extinguished.

Verify that the AUTO SLAT FAIL light is extinguished.

NAVIGATION panel Set

737 Flight Crew Operations Manual

- VHF NAV transfer switch – NORMAL
- IRS transfer switch – NORMAL
- FMC transfer switch – NORMAL
- DISPLAYS panelSet
- SOURCE selector – AUTO
- CONTROL PANEL select switch – NORMAL
- Fuel panelSet
- Verify that the ENG VALVE CLOSED lights are illuminated dim.
- Verify that the SPAR VALVE CLOSED lights are illuminated dim.
- Verify that the FILTER BYPASS lights are extinguished.
- CROSSFEED selector – Closed
- Verify that the VALVE OPEN light is extinguished.
- FUEL PUMP switches – OFF
- Verify that the center tank fuel pump LOW PRESSURE lights are extinguished.
- Verify that the main tank fuel pump LOW PRESSURE lights are illuminated.
- Electrical panelSet
- BATTERY switch – Guard closed
- CAB/UTIL power switch – ON
- IFE/PASS SEAT power switch – ON
- STANDBY POWER switch – Guard closed
- Verify that the STANDBY PWR OFF light is extinguished.
- Verify that the BAT DISCHARGE light is extinguished.
- Verify that the TR UNIT light is extinguished.
- Verify that the ELEC light is extinguished.

Generator drive DISCONNECT switches – Guards closed

Verify that the DRIVE lights are illuminated.

BUS TRANSFER switch – Guard closed

Verify that the TRANSFER BUS OFF lights are extinguished.

Verify that the SOURCE OFF lights are extinguished.

Verify that the GEN OFF BUS lights are illuminated.

Overheat and fire protection panel Check

Do this check if the flight crew did not do the Electrical Power Up supplementary procedure. This check is needed once per flight day.

Verify that the engine No. 1, APU, and engine No. 2 fire switches are in.

Alert ground personnel before the following test is accomplished:

OVERHEAT DETECTOR switches – NORMAL

TEST switch – Hold to FAULT/INOP

Verify that the MASTER CAUTION lights are illuminated.

Verify that the OVHT/DET annunciator is illuminated.

Verify that the FAULT light is illuminated.

If the FAULT light fails to illuminate, the fault monitoring system is inoperative.

737 Flight Crew Operations Manual

Verify that the APU DET INOP light is illuminated.

Do not run the APU if the APU DET INOP light does not illuminate.

Note: The fire warning light flashes and the horn sounds on the APU ground control panel when this test is done with the APU running. This can be mistaken by the ground crew as an APU fire.

TEST switch – Hold to OVHT/FIRE

Verify that the fire warning bell sounds.

Verify that the master FIRE WARN lights are illuminated.

Verify that the MASTER CAUTION lights are illuminated.

Verify that the OVHT/DET annunciator is illuminated.

Master FIRE WARN light – Push

Verify that the master FIRE WARN lights are extinguished.

Verify that the fire warning bell cancels.

Verify that the engine No. 1, APU and engine No. 2 fire switches stay illuminated.

Verify that the ENG 1 OVERHEAT and ENG 2 OVERHEAT lights stay illuminated.

Verify that the WHEEL WELL light stays illuminated.

EXTINGUISHER TEST switch – Check

TEST switch – Position to 1 and hold.

Verify that the three green extinguisher test lights are illuminated.

TEST switch – Release

Verify that the three green extinguisher test lights are extinguished.

Repeat for test position 2.

APU switch (as needed) START

Note: If extended APU operation is needed on the ground, position an AC operated fuel pump ON. If fuel is loaded in the center tank, position the left center tank fuel pump switch ON to prevent a fuel imbalance before takeoff.

CAUTION: Center tank fuel pump switches should be positioned ON only if the fuel quantity in the center tank exceeds 453 kgs.

CAUTION: Do not operate the center tank fuel pumps with the flight deck unattended.

Note: Whenever the APU is operating and AC electrical power is on the airplane busses, operate at least one fuel boost pump to supply fuel under pressure to the APU to extend the service life of the APU fuel control unit.

When the APU GEN OFF BUS light is illuminated:

APU GENERATOR bus switches – ON

Verify that the SOURCE OFF lights are extinguished.

Verify that the TRANSFER BUS OFF lights are extinguished.

EQUIPMENT COOLING switches NORM

Verify that the OFF lights are extinguished.

EMERGENCY EXIT LIGHTS switch Guard closed

Verify that the NOT ARMED light is extinguished.

Passenger signs Set

FASTEN BELTS switch – AUTO or ON

Windshield WIPER selectors PARK

Verify that the windshield wipers are stowed.

WINDOW HEAT switches ON

Position switches ON at least 10 minutes before takeoff.

Verify that the OVERHEAT lights are extinguished.

737 Flight Crew Operations Manual

Verify that the ON lights are illuminated (except at high ambient temperatures.)

PROBE HEAT switches OFF

Verify that all lights are illuminated.

WING ANTI-ICE switch OFF

Verify that the VALVE OPEN lights are extinguished.

ENGINE ANTI-ICE switches OFF

Verify that the COWL ANTI-ICE lights are extinguished.

Verify that the COWL VALVE OPEN lights are extinguished.

Hydraulic panel Set

ENGINE HYDRAULIC PUMPS switches – ON

Verify that the LOW PRESSURE lights are illuminated.

ELECTRIC HYDRAULIC PUMPS switches – OFF

Verify that the OVERHEAT lights are extinguished.

Verify that the LOW PRESSURE lights are illuminated.

Air conditioning panel Set

AIR TEMPERATURE source selector – As needed

YC201 - YC207

TRIM AIR switch – ON

YA371 - YA377, YE321 - YE326

Verify that the DUCT OVERHEAT lights are extinguished.

YC201 - YC207

Verify that the ZONE TEMP lights are extinguished.

Temperature selectors – As needed

Verify that the RAM DOOR FULL OPEN lights are illuminated.

YA371 - YA377, YE321 - YE326

RECIRCULATION FAN switch – AUTO

YC201 - YC207

RECIRCULATION FAN switches – AUTO

Air conditioning PACK switches – AUTO or HIGH

ISOLATION VALVE switch – OPEN

Engine BLEED air switches – ON

APU BLEED air switch – ON

Verify that the DUAL BLEED light is illuminated.

YA371 - YA377, YE321 - YE326

Verify that the PACK TRIP OFF lights are extinguished.

YC201 - YC207

Verify that the PACK lights are extinguished.

Verify that the WING–BODY OVERHEAT lights are extinguished.

Verify that the BLEED TRIP OFF lights are extinguished.

Cabin pressurization panel Set

Verify that the AUTO FAIL light is extinguished.

Verify that the OFF SCHED DESCENT light is extinguished.

FLIGHT ALTITUDE indicator – Cruise altitude

LANDING ALTITUDE indicator – Destination field elevation

737 Flight Crew Operations Manual

-
- Pressurization mode selector – AUTO
- Lighting panelSet
- LANDING light switches – RETRACT and OFF
- RUNWAY TURNOFF light switches – OFF
- TAXI light switch – OFF
- Ignition select switch IGN L or R
- Alternate the ignition select switch position on subsequent starts.
- ENGINE START switches OFF
- Lighting panelSet
- LOGO light switch – As needed
- POSITION light switch – As needed
- ANTI-COLLISION light switch – OFF
- WING illumination switch – As needed
- WHEEL WELL light switch – As needed
- Mode control panelSet
- COURSE(S) – Set
- FLIGHT DIRECTOR switch – ON
- Move the switch for the pilot flying to ON first.
- EFIS control panelSet
- MINIMUMS reference selector – RADIO or BARO
- MINIMUMS selector – Set decision height or altitude reference
- FLIGHT PATH VECTOR switch – As needed
- METERS switch – As needed
- BAROMETRIC reference selector – IN or HPA
- BAROMETRIC selector – Set local altimeter setting
- VOR/ADF switches – As needed

Mode selector – MAP

CENTER switch – As needed

Range selector – As needed

TRAFFIC switch – As needed

WEATHER RADAR – Off

Verify that the weather radar indications are not shown on the MAP.

Map switches – As needed

Oxygen Test and set

Crew oxygen pressure – Check

Verify that the pressure is sufficient for dispatch.

Oxygen mask – Stowed and doors closed

RESET/TEST switch – Push and hold

Verify that the yellow cross shows momentarily in the flow indicator.

Verify that air flow is heard.

EMERGENCY/TEST selector – Push and hold

Continue to hold the RESET/TEST switch down and push the EMERGENCY/TEST selector for 5 seconds. Verify that the yellow cross shows continuously in the flow indicator.

Verify that the crew oxygen pressure does not decrease more than 100 psig.

If the oxygen cylinder valve is not in the full open position, pressure can:

- decrease rapidly, or
- decrease more than 100 psig, or
- increase slowly back to normal.

Release the RESET/TEST switch and the EMERGENCY/TEST selector. Verify that the yellow does not show in the flow indicator.

Normal/100% selector – 100%

737 Flight Crew Operations Manual

ClockSet

TIME/DATE pushbutton - UTC time

Display select panelSet

MAIN PANEL DISPLAY UNITS selector – NORM

LOWER DISPLAY UNIT selector – NORM

Disengage light TEST switchHold to 1

Verify that the A/P light is illuminated steady amber.

Verify that the A/T light is illuminated steady amber.

Verify that the FMC light is illuminated steady amber.

Disengage light TEST switchHold to 2

Verify that the A/P light is illuminated steady red.

Verify that the A/T light is illuminated steady red.

Verify that the FMC light is illuminated steady amber.

Do the Initial Data and Navigation Data steps from the CDU Preflight Procedure and verify that the IRS alignment is complete before checking the flight instruments.

Flight instruments Check

Verify that the flight instrument indications are correct.

Verify that only these flags are shown:

- TCAS OFF
- NO VSPD until V-speeds are selected
- expected RMI flags

Verify that the flight mode annunciations are correct:

Note: Autothrottle mode and AFDS status are blank until the MCP is set in the Before Start procedure.

- autothrottle mode is blank
- roll mode is blank
- pitch mode is blank
- AFDS status is FD

Select the map mode.

GROUND PROXIMITY panel	Check
FLAP INHIBIT switch – Guard closed	
GEAR INHIBIT switch – Guard closed	
TERRAIN INHIBIT switch – Guard closed	
Verify that the INOP light is extinguished.	
Landing gear panel	Set
LANDING GEAR lever – DN	
Verify that the green landing gear indicator lights are illuminated.	
Verify that the red landing gear indicator lights are extinguished.	
AUTOBRAKE selector	RTO
Verify that the AUTOBRAKE DISARM light is extinguished	
ANTISKID INOP light	Verify extinguished
Engine display control panel	Set
N1 SET selector – AUTO	
SPEED REFERENCE selector – AUTO	
FUEL FLOW switch – RATE	
Engine instruments	Check
Verify that the primary and secondary engine indications show existing conditions.	
Verify that no exceedance is shown.	
YA373 - YA377, YC202 - YE326	
Verify that the hydraulic quantity indications do not show RF.	
CARGO FIRE panel	Check
This check is needed once per flight day or following a flight crew change.	
DETECTOR SELECT switches – NORM	

737 Flight Crew Operations Manual

TEST switch – Push

Verify that the fire warning bell sounds.

Verify that the master FIRE WARN lights are illuminated.

Master FIRE WARN light – Push

Verify that the master FIRE WARN lights are extinguished.

Verify that the fire warning bell cancels.

Verify that the FWD and AFT lights stay illuminated.

Verify that the DETECTOR FAULT light stays extinguished.

Verify that the green EXTINGUISHER test lights stay illuminated.

Verify that the DISCH light stays illuminated.

Radio tuning panelSet

**WARNING: Do not key HF radio while airplane is being fueled.
Injury to personnel or fire may result.**

Verify that the OFF light is extinguished.

VHF NAVIGATION radiosSet for departure

Audio control panelSet

ADF radiosSet

Transponder panelSet

STABILIZER TRIM override switchGuard closed

**WARNING: Do not put objects between the seat and the aisle
stand. Injury can occur when the seat is adjusted.**

SeatAdjust

Adjust the seat for optimum eye reference.

Verify a positive horizontal (fore and aft) seat lock.

Rudder pedalsAdjust

Adjust the rudder pedals to allow full rudder pedal and brake pedal movement.

Seat belt and shoulder harness Adjust

Do the PREFLIGHT checklist on the captain's command.

Preflight Procedure – Captain

The captain normally does this procedure. The first officer may do this procedure if needed.

Lights Test

Master LIGHTS TEST and DIM switch – TEST

The fire warning lights are not checked during this test. Use individual test switches or push to test features to check lights which do not illuminate during the light test. Use scan flow to verify that all other lights are flashing or illuminated. Verify that all system annunciator panel lights are illuminated.

Master LIGHTS TEST and DIM switch – As needed

EFIS control panel Set

MINIMUMS reference selector – RADIO or BARO

MINIMUMS selector – Set decision height or altitude reference

FLIGHT PATH VECTOR switch – As needed

METERS switch – As needed

BAROMETRIC reference selector – IN or HPA

BAROMETRIC selector – Set local altimeter setting

VOR/ADF switches – As needed

Mode selector – MAP

CENTER switch – As needed

Range selector – As needed

TRAFFIC switch – As needed

WEATHER RADAR – Off

Verify that the weather radar indications are not shown on the MAP.

737 Flight Crew Operations Manual

Map switches – As needed

Mode control panelSet

COURSE(S) – Set

FLIGHT DIRECTOR switch – ON

Move the switch for the pilot flying to ON first.

Bank angle selector – As needed

Autopilot DISENGAGE bar – UP

Oxygen Test and set

Crew oxygen pressure – Check

Verify that the pressure is sufficient for dispatch.

Oxygen mask – Stowed and doors closed

RESET/TEST switch – Push and hold

Verify that the yellow cross shows momentarily in the flow indicator.

Verify that air flow is heard.

EMERGENCY/TEST selector – Push and hold

Continue to hold the RESET/TEST switch down and push the EMERGENCY/TEST selector for 5 seconds. Verify that the yellow cross shows continuously in the flow indicator.

Verify that the crew oxygen pressure does not decrease more than 100 psig.

If the oxygen cylinder valve is not in the full open position, pressure can:

- decrease rapidly, or
- decrease more than 100 psig, or
- increase slowly back to normal.

Release the RESET/TEST switch and the EMERGENCY/TEST selector. Verify that the yellow does not show in the flow indicator.

Normal/100% selector – 100%

Clock Set

TIME/DATE pushbutton - UTC time

NOSE WHEEL STEERING switch..... Guard closed

Display select panel..... Set

MAIN PANEL DISPLAY UNITS selector – NORM

LOWER DISPLAY UNIT selector – NORM

Disengage light TEST switch Hold to 1

Verify that the A/P light is illuminated steady amber.

Verify that the A/T light is illuminated steady amber.

Verify that the FMC light is illuminated steady amber.

Disengage light TEST switch Hold to 2

Verify that the A/P light is illuminated steady red.

Verify that the A/T light is illuminated steady red.

Verify that the FMC light is illuminated steady amber.

STAB OUT OF TRIM light Verify extinguished

Do the Initial Data and Navigation Data steps from the CDU Preflight Procedure and verify that the IRS alignment is complete before checking the flight instruments.

Flight instruments Check

Verify that the flight instrument indications are correct.

Verify that only these flags are shown:

- TCAS OFF
- NO VSPD until V-speeds are selected
- expected RMI flags

737 Flight Crew Operations Manual

Verify that the flight mode annunciations are correct:

Note: Autothrottle mode and AFDS status are blank until the MCP is set in the Before Start procedure.

- autothrottle mode is blank
- roll mode is blank
- pitch mode is blank
- AFDS status is FD

Select the map mode.

YA373, YC202, YE324, YE325

Standby instruments Check

Standby horizon – Set

Gyro caging control – Pull, then release

Approach mode selector – As needed

Verify that the flight instrument indications are correct.

Verify that no flags are shown.

Standby altimeter – Set

Verify that the flight instrument indications are correct.

Verify that no flags are shown.

YA371, YA372, YA374 - YC201, YC203 - YE323, YE326

Integrated standby flight displaySet

Verify that the approach mode display is blank.

Set the altimeter.

Verify that the flight instrument indications are correct.

Verify that no flags or messages are shown.

Standby RMI.....Set

Select either VOR or ADF.

SPEEDBRAKE leverDOWN detent

Verify that the SPEEDBRAKE ARMED light is extinguished.

Verify that the SPEEDBRAKE DO NOT ARM light is extinguished.

Verify that the SPEEDBRAKE EXTENDED light is extinguished.

Reverse thrust levers Down

Forward thrust levers Closed

FLAP lever Set

Set the flap lever to agree with the flap position.

Parking brake Set

Verify that the parking brake warning light is illuminated

Note: Do not assume that the parking brake will prevent airplane movement. Accumulator pressure can be insufficient.

Engine start levers CUTOFF

STABILIZER TRIM cutout switches NORMAL

Radio tuning panel Set

WARNING: Do not key the HF radio when the airplane is being refueled. Injury to personnel or fire can occur.

Verify that the OFF light is extinguished.

VHF NAVIGATION radios Set for departure

Audio control panel Set

WARNING: Do not put objects between the seat and the aisle stand. Injury can occur when the seat is adjusted.

Seat Adjust

Adjust the seat for optimum eye reference.

Verify a positive horizontal (fore and aft) seat lock.

Rudder pedals Adjust

Adjust the rudder pedals to allow full rudder pedal and brake pedal movement.



737 Flight Crew Operations Manual

Seat belt and shoulder harness Adjust
Call “PREFLIGHT CHECKLIST.”

Before Start Procedure

Start the Before Start Procedure after papers are on board.

Flight deck door Closed and locked F/O

Verify that the LOCK FAIL light is extinguished.

Do the CDU Preflight Procedure – Performance Data steps before completing this procedure.

CDU display Set C, F/O

Normally the PF selects the TAKEOFF REF page.

Normally the PM selects the LEGS page.

N1 bugs Check C, F/O

Verify that the N1 reference bugs are correct.

IAS bugs Set C, F/O

YA371, YA372, YC201

Verify that the speed bugs are at V1, VR, V2 + 15, and flaps up maneuvering speed.

MCP Set C

AUTOTHROTTLE ARM switch – ARM

IAS/MACH selector – Set V2

Arm LNAV as needed.

Initial heading – Set

Initial altitude – Set

Taxi and Takeoff briefings Complete C, F/O

The pilot who will do the takeoff does the taxi and takeoff briefings.

Exterior doors Verify closed F/O

Flight deck windows Closed and locked C, F/O

Start clearance Obtain C, F/O

Obtain a clearance to pressurize the hydraulic systems.

Obtain a clearance to start the engines.

If pushback is needed:

Verify that the nose gear steering lockout pin is installed, or, if the nose gear steering lockout pin is not used, depressurize hydraulic system A during the hydraulic panel set step. C, F/O

Fuel panel Set F/O

If the center tank fuel quantity exceeds 460 kilograms:

LEFT and RIGHT CENTER FUEL PUMPS switches – ON

Verify that the LOW PRESSURE lights illuminate momentarily and then extinguish.

If the LOW PRESSURE light stays illuminated turn off the CENTER FUEL PUMPS switch.

AFT and FORWARD FUEL PUMPS switches – ON

Verify that the LOW PRESSURE lights are extinguished.

Hydraulic panel Set F/O

If pushback is needed and the nose gear steering lockout pin is not installed:

**WARNING: Do not pressurize hydraulic system A.
Unwanted tow bar movement can occur.**

System A HYDRAULIC PUMP switches – OFF

Verify that the system A pump LOW PRESSURE lights are illuminated.

System B electric HYDRAULIC PUMP switch – ON

Verify that the system B electric pump LOW PRESSURE light is extinguished.

Establish communications with ground handling personnel. C

CAUTION: Do not hold or turn the nose wheel steering wheel during pushback or towing. This can damage the nose gear or the tow bar.

CAUTION: Do not use airplane brakes to stop the airplane during pushback or towing. This can damage the nose gear or the tow bar.

Set or release the parking brake as directed by ground handling personnel. C

When pushback or towing is complete:

Verify that the tow bar is disconnected. C

Verify that the nose gear steering lockout pin is removed. C

System A HYDRAULIC PUMPS switches – ON. F/O

Engine Start Procedure

YA373 - YA377, YC202 - YE326

Select the secondary engine indications. F/O

Air conditioning PACK switchesOFF F/O

Start sequenceAnnounce C

Call “START ___ ENGINE” C

ENGINE START switchGRD F/O

Verify that the N2 RPM increases. C, F/O

When N1 rotation is seen and N2 is at 25%, or (if 25% N2 is not possible), at maximum motoring and a minimum of 20% N2:

Engine start leverIDLE C

Monitor fuel flow and EGT indications. C, F/O

At 56% N2, verify that the ENGINE START switch moves to OFF. If not, move the ENGINE START switch to OFF. F/O

Verify that the START VALVE OPEN alert extinguishes when the ENGINE START switch moves to OFF. F/O

737 Flight Crew Operations Manual

Call: "STARTER CUTOUT." F/O

Monitor N1, N2, EGT, fuel flow and oil pressure for normal indications while the engine accelerates to a stable idle. C, F/O

After the engine is stable at idle, start the other engine.

Starter duty cycle:

- Do not exceed 2 minutes during each start attempt
- A minimum of 10 seconds is needed between start attempts

Normal engine start considerations:

- do not move an engine start lever to idle early or a hot start can occur
- keep a hand on the engine start lever while monitoring RPM, EGT and fuel flow until stable
- if fuel is shutoff accidentally (by closing the engine start lever) do not reopen the engine start lever in an attempt to restart the engine
- failure of the ENGINE START switch to stay in GRD until the starter cutout RPM can cause a hot start. Do not re-engage the ENGINE START switch until engine RPM is below 20% N2.

Do the ABORTED ENGINE START checklist for one or more of the following abort start conditions:

- the N1 or N2 does not increase or increases very slowly after the EGT increases
- there is no oil pressure indication by the time that the engine is stable at idle
- the EGT does not increase by 10 seconds after the engine start lever is moved to IDLE
- the EGT quickly nears or exceeds the start limit

Before Taxi Procedure

GENERATOR 1 and 2 switches	ON	F/O
PROBE HEAT switches	ON	F/O
WING ANTI-ICE switch	As needed	F/O
ENGINE ANTI-ICE switches	As needed	F/O
PACK switches	AUTO	F/O
ISOLATION VALVE switch	AUTO	F/O
APU BLEED air switch	OFF	F/O

APU switch	OFF	F/O
ENGINE START switches	CONT	F/O
Engine start levers	IDLE detent	C
Verify that the ground equipment is clear.		C, F/O
Call “FLAPS ___” as needed for takeoff.		C
Flap lever	Set takeoff flaps	F/O
Verify that the LE FLAPS EXT green light is illuminated.		
Flight controls	Check	C
Move the control wheel and the control column to full travel in both directions and verify:		
• freedom of movement		
• that the controls return to center		
Hold the nose wheel steering wheel during the rudder check to prevent nose wheel movement.		
Move the rudder pedals to full travel in both directions and verify:		
• freedom of movement		
• that the rudder pedals return to center		
YA373 - YA377, YC202 - YE326		
Blank the lower display unit.		F/O
Transponder	As needed	F/O
At airports where ground tracking is not available, select STANDBY.		
At airports equipped to track airplanes on the ground, select an active transponder setting, but not a TCAS mode.		
Recall	Check	C, F/O
Verify that all system annunciator panel lights illuminate and then extinguish.		
Update changes to the taxi briefing, as needed.		C or PF
Call “BEFORE TAXI CHECKLIST.”		C
Do the BEFORE TAXI checklist.		F/O



737 Flight Crew Operations Manual

Before Takeoff Procedure [AD 2002-19-52 and AD 2002-24-51]

Pilot Flying	Pilot Monitoring
	Check the center tank fuel quantity. Both center tank fuel pump switches must be OFF for takeoff if center tank fuel is less than 2300 kilograms. Do not accomplish the CONFIG non-normal checklist with less than 2300 kilograms in the center tank prior to takeoff.
	Notify the cabin crew to prepare for takeoff. Verify that the cabin is secure.
The pilot who will do the takeoff updates changes to the takeoff briefing as needed.	
Set the weather radar display as needed.	
Set the terrain display as needed.	
Call "BEFORE TAKEOFF CHECKLIST."	Do the BEFORE TAKEOFF checklist.

**Before Takeoff Procedure [Alternate Method of Compliance
(AMOC) to AD 2002-24-51]**

Pilot Flying	Pilot Monitoring
	Check the center tank fuel quantity. Both center tank fuel pump switches must be OFF for takeoff if center tank fuel is less than 2300 kilograms. Do not accomplish the CONFIG non-normal checklist with less than 2300 kilograms in the center tank prior to takeoff.
	Notify the cabin crew to prepare for takeoff. Verify that the cabin is secure.
The pilot who will do the takeoff updates changes to the takeoff briefing as needed.	
Set the weather radar display as needed.	
Set the terrain display as needed.	
Call “BEFORE TAKEOFF CHECKLIST.”	Do the BEFORE TAKEOFF checklist.

**Before Takeoff Procedure [Alternate Method of Compliance
(AMOC) to AD 2002-24-51 for Airplanes with Master Caution
System Logic Change and Automatic Shutoff]**

Pilot Flying	Pilot Monitoring
	Notify the cabin crew to prepare for takeoff. Verify that the cabin is secure.
The pilot who will do the takeoff updates changes to the takeoff briefing as needed.	
Set the weather radar display as needed.	
Set the terrain display as needed.	
Call “BEFORE TAKEOFF CHECKLIST.”	Do the BEFORE TAKEOFF checklist.

Takeoff Procedure

Pilot Flying	Pilot Monitoring
	Enter the runway offset on the CDU TAKEOFF REF page.
	When entering the departure runway, set the STROBE light switch to ON. Use other lights as needed.
Verify that the brakes are released. Align the airplane with the runway.	When cleared for takeoff, set the FIXED LANDING light switches to ON. Set the transponder mode selector to TA/RA.
Advance the thrust levers to approximately 40% N1. Allow the engines to stabilize.	
Push the TO/GA switch.	
Verify that the correct takeoff thrust is set.	
	Monitor the engine instruments during the takeoff. Call out any abnormal indications. Adjust takeoff thrust before 60 knots as needed. During strong headwinds, if the thrust levers do not advance to the planned takeoff thrust by 60 knots, manually advance the thrust levers.
After takeoff thrust is set, the captain's hand must be on the thrust levers until V1.	
Monitor airspeed. Maintain light forward pressure on the control column.	Monitor airspeed and call out any abnormal indications.
Verify 80 knots and call "CHECK."	Call "80 KNOTS."
Verify V1 speed.	Call "V1."
At VR, rotate toward 15° pitch attitude. After liftoff, follow F/D commands. Establish a positive rate of climb.	At VR call "ROTATE." Monitor airspeed and vertical speed.

Pilot Flying	Pilot Monitoring
Verify a positive rate of climb on the altimeter and call “GEAR UP.”	Verify a positive rate of climb on the altimeter and call “POSITIVE RATE.” Set the landing gear lever to UP.
Above 400 feet radio altitude, call for a roll mode as needed.	Select or verify the roll mode.
At thrust reduction height verify that climb thrust is set.	
At acceleration height, call “SET FLAPS UP SPEED.”	Set the flaps up maneuvering speed.
Verify acceleration. Call “FLAPS ___” according to the flap retraction schedule.	Set the FLAP lever as directed. Monitor flaps and slats retraction.
After flaps and slats retraction is complete, call “VNAV.”	Push the VNAV switch.
Engage the autopilot after minimum altitude for autopilot engagement.	
	After flap retraction is complete: <ul style="list-style-type: none"> • Set or verify engine bleeds and air conditioning packs are operating • Set the engine start switches as needed • Set the AUTOBRAKE selector to OFF • Set the landing gear lever to OFF after landing gear retraction is complete
Call “AFTER TAKEOFF CHECKLIST.”	Do the AFTER TAKEOFF checklist.

CAUTION: Do not allow the shoulder harness straps to retract quickly. Buckles can pull or damage circuit breakers.

737 Flight Crew Operations Manual**Takeoff Flap Retraction Speed Schedule**

Takeoff Flaps	At Speed (display)	Select Flaps
25	V2 + 15	15
	"15"	5
	"5"	1
	"1"	UP
15 or 10	V2 + 15	5
	"5"	1
	"1"	UP
5	V2 + 15	1
	"1"	UP
1	"1"	UP
Limit bank angle to 15° until reaching V2 + 15		

Climb and Cruise Procedure [AD 2002-19-52 and AD 2002-24-51]

Complete the After Takeoff Checklist before starting the Climb and Cruise Procedure.

Pilot Flying	Pilot Monitoring
	If the center tank fuel pump switches were OFF for takeoff and the center tank contains more than 500 kilograms, position both center tank fuel pump switches ON above 10,000 feet or after the pitch attitude has been reduced to begin acceleration to a climb speed of 250 knots or greater.
	During climb, position both center tank fuel pump switches OFF when center tank fuel quantity reaches approximately 500 kilograms.
	At or above 10,000 feet MSL, set the LANDING light switches to OFF.
	Set the passenger signs as needed.
At transition altitude, set and crosscheck the altimeters to standard.	
	When established in a level attitude at cruise, if the center tank contains more than 500 kilograms and the center tank fuel pump switches are OFF, position the center tank fuel pump switches ON again. Position both center tank fuel pump switches OFF when center tank fuel quantity reaches approximately 500 kilograms.
	During the last hour of cruise on all ETOPS flights, do a Fuel Crossfeed Valve check.
	Before the top of descent, modify the active route as needed for the arrival and approach.

Climb and Cruise Procedure [Alternate Method of Compliance (AMOC) to AD 2002-24-51]

Complete the After Takeoff Checklist before starting the Climb and Cruise Procedure.

Pilot Flying	Pilot Monitoring
	If the center tank fuel pump switches were OFF for takeoff and the center tank contains more than 950 kilograms, position both center tank fuel pump switches ON above 10,000 feet or after the pitch attitude has been reduced to begin acceleration to a climb speed of 250 knots or greater.
	At or above 10,000 feet MSL, set the LANDING light switches to OFF.
	Set the passenger signs as needed.
At transition altitude, set and crosscheck the altimeters to standard.	
	<p>During climb or cruise, position one center tank fuel pump switch OFF when center tank fuel quantity reaches approximately 950 kilograms. Open the crossfeed valve to minimize fuel imbalance.</p> <p>Position the remaining center tank fuel pump switch OFF without delay and close the crossfeed valve when the Master Caution and FUEL system annunciator illuminate.</p>
	During the last hour of cruise on all ETOPS flights, do a Fuel Crossfeed Valve check.
	Before the top of descent, modify the active route as needed for the arrival and approach.

Climb and Cruise Procedure [Alternate Method of Compliance (AMOC) to AD 2002-24-51 for Airplanes with Master Caution System Logic Change and Automatic Shutoff]

Complete the After Takeoff Checklist before starting the Climb and Cruise Procedure.

Pilot Flying	Pilot Monitoring
	At or above 10,000 feet MSL, set the LANDING light switches to OFF.
	Set the passenger signs as needed.
At transition altitude, set and crosscheck the altimeters to standard.	
	During climb, position both center tank fuel pump switches OFF when one center tank fuel pump LOW PRESSURE light illuminates.
	When established in a level attitude at cruise, if the center tank contains usable fuel and the center tank fuel pump switches are OFF, position the center tank fuel pump switches ON again. Position both center tank fuel pump switches OFF when the center tank is empty.
	During the last hour of cruise on all ETOPS flights, do a Fuel Crossfeed Valve check.
	Before the top of descent, modify the active route as needed for the arrival and approach.

Descent Procedure [AD 2002-19-52 and AD 2002-24-51]

Start the Descent Procedure before the airplane descends below the cruise altitude for arrival at destination.

Complete the Descent Procedure by 10,000 feet MSL.

Pilot Flying	Pilot Monitoring
	During descent, position both center tank fuel pump switches OFF when center tank fuel quantity reaches approximately 1400 kilograms. Do not accomplish the CONFIG non-normal checklist.
	Verify that pressurization is set to landing altitude.
Review the system annunciator lights.	Recall and review the system annunciator lights.
Verify VREF on the APPROACH REF page.	
Set the RADIO/BARO minimums as needed for the approach.	
Set or verify the navigation radios and course for the approach.	
	Set the AUTOBRAKE selector to the needed brake setting
Do the approach briefing.	
Call "DESCENT CHECKLIST."	Do the DESCENT checklist.

Descent Procedure [Alternate Method of Compliance (AMOC) to AD 2002-24-51]

Start the Descent Procedure before the airplane descends below the cruise altitude for arrival at destination.

Complete the Descent Procedure by 10,000 feet MSL.

Pilot Flying	Pilot Monitoring
	<p>During descent, position one center tank fuel pump switch OFF when center tank fuel quantity reaches approximately 1400 kilograms. Open the crossfeed valve to minimize fuel imbalance.</p> <p>Turn the remaining center tank fuel pump switch OFF without delay and close the crossfeed valve when the Master Caution and FUEL system annunciator illuminate.</p>
	<p>If established in level flight for an extended period of time prior to approach and landing with more than 950 kilograms in the center tank and the center tank fuel pump switches OFF, one center tank fuel pump switch may be turned ON again. Open the crossfeed valve to minimize fuel imbalance.</p> <p>Turn the remaining center tank fuel pump switch OFF without delay and close the crossfeed valve when the Master Caution and FUEL system annunciator illuminate.</p>
	Verify that pressurization is set to landing altitude.
Review the system annunciator lights.	Recall and review the system annunciator lights.
Verify VREF on the APPROACH REF page.	
Set the RADIO/BARO minimums as needed for the approach.	



737 Flight Crew Operations Manual

Pilot Flying	Pilot Monitoring
Set or verify the navigation radios and course for the approach.	
	Set the AUTOBRAKE selector to the needed brake setting
Do the approach briefing.	
Call "DESCENT CHECKLIST."	Do the DESCENT checklist.

Descent Procedure [Alternate Method of Compliance (AMOC) to AD 2002-24-51 for Airplanes with Master Caution System Logic Change and Automatic Shutoff]

Start the Descent Procedure before the airplane descends below the cruise altitude for arrival at destination.

Complete the Descent Procedure by 10,000 feet MSL.

Pilot Flying	Pilot Monitoring
	During descent, position both center tank fuel pump switches OFF when one center tank fuel LOW PRESSURE light illuminates.
	If established in level flight for an extended period of time with usable fuel in the center tank and the center tank fuel pump switches OFF, the center tank fuel pump switches may be positioned ON again. Position both center tank fuel pump switches OFF when the center tank is empty.
	Verify that pressurization is set to landing altitude.
Review the system annunciator lights.	Recall and review the system annunciator lights.
Verify VREF on the APPROACH REF page.	
Set the RADIO/BARO minimums as needed for the approach.	
Set or verify the navigation radios and course for the approach.	
	Set the AUTOBRAKE selector to the needed brake setting
Do the approach briefing.	
Call "DESCENT CHECKLIST."	Do the DESCENT checklist.

Approach Procedure

The Approach Procedure is normally started at transition level.

Complete the Approach Procedure before:

- the initial approach fix, or
- the start of radar vectors to the final approach course, or
- the start of a visual approach

For a BCRS approach, enter the front course in the Mode Control Panel COURSE window. Do not select VOR/LOC.

Pilot Flying	Pilot Monitoring
	Set the passenger signs as needed.
	At or above 10,000 feet MSL, set the FIXED LANDING light switches to ON.
At transition level, set and crosscheck the altimeters.	
Update changes to the arrival and approach, as needed.	
Update the approach briefing as needed.	
Call "APPROACH CHECKLIST."	Do the APPROACH checklist.

Flap Extension Schedule

Current Flap Position	At Speedtape "Display"	Select Flaps	Command Speed for Selected Flaps
UP	"UP"	1	"1"
1	"1"	5	"5"
5	"5"	15	"15"
15	"15"	30 or 40	(VREF30 or VREF40) + wind additives

Landing Procedure

Pilot Flying	Pilot Monitoring
	Notify the cabin crew to prepare for landing. Verify that the cabin is secure.
Call “FLAPS ___” according to the flap extension schedule.	Set the flap lever as directed. Monitor flaps and slats extension.
When on localizer intercept heading: <ul style="list-style-type: none"> • verify that the ILS is tuned and identified • verify that the LOC and G/S pointers are shown 	
Arm the APP mode. Engage the other autopilot.	
<p style="text-align: center;">WARNING: When using LNAV to intercept the final approach course, LNAV might parallel the localizer without capturing it. The airplane can then descend on the glide slope with the localizer not captured.</p>	
Use HDG SEL to intercept the final approach course as needed.	
Verify that the localizer is captured.	
	Call “GLIDE SLOPE ALIVE.”
At glide slope alive, call: <ul style="list-style-type: none"> • “GEAR DOWN” • “FLAPS 15” 	Set the landing gear lever to DN. Verify that the green landing gear indicator lights are illuminated. Set the flap lever to 15. Set the engine start switches to CONT.
Set the speedbrake lever to ARM. Verify that the SPEEDBRAKE ARMED light is illuminated.	
At glide slope capture, call “FLAPS ___” as needed for landing.	Set the flap lever as directed.
Set the missed approach altitude on the MCP.	
Call “LANDING CHECKLIST.”	Do the LANDING checklist.
At the final approach fix or OM, verify the crossing altitude.	
Monitor the approach.	
Verify the AFDS status at 500 feet radio altitude.	

Go-Around and Missed Approach Procedure

Pilot Flying	Pilot Monitoring
At the same time: <ul style="list-style-type: none"> • push the TO/GA switch • call “FLAPS 15” 	Position the FLAP lever to 15 and monitor flap retraction
Verify: <ul style="list-style-type: none"> • the rotation to go-around attitude • that the thrust increases 	
	Verify that the thrust is sufficient for the go-around or adjust as needed.
Verify a positive rate of climb on the altimeter and call “GEAR UP.”	Verify a positive rate of climb on the altimeter and call “POSITIVE RATE.” Set the landing gear lever to UP.
	Verify that the missed approach altitude is set.
Above 400 feet, select appropriate roll mode and verify proper mode annunciation.	Observe mode annunciation.
Verify that the missed approach route is tracked.	
At acceleration height, call “FLAPS ___” according to the flap retraction schedule.	Set the FLAP lever as directed. Monitor flaps and slats retraction.
After flap retraction to the planned flap setting, select LVL CHG. VNAV may be selected if the flaps are up.	
Verify that climb thrust is set.	
Verify that the missed approach altitude is captured.	
	Set the landing gear lever to OFF after landing gear retraction is complete. Set the engine start switches as needed.
Call “AFTER TAKEOFF CHECKLIST.”	Do the AFTER TAKEOFF checklist.

Landing Roll Procedure

Pilot Flying	Pilot Monitoring
Disengage the autopilot. Control the airplane manually.	
Verify that the thrust levers are closed. Verify that the SPEEDBRAKE lever is up.	Verify that the SPEEDBRAKE lever is UP. Call "SPEEDBRAKES UP." If the SPEEDBRAKE lever is not UP, call "SPEEDBRAKES NOT UP."
Verify correct autobrake operation.	
WARNING: After the reverse thrust levers are moved, a full stop landing must be made. If an engine stays in reverse, safe flight is not possible.	
Without delay, move the reverse thrust levers to the interlocks and hold light pressure until the interlocks release. Then apply reverse thrust as needed.	
By 60 knots, start movement of the reverse thrust levers to be at the reverse idle detent before taxi speed.	Call "60 KNOTS."
After the engines are at reverse idle, move the reverse thrust levers full down.	
Before taxi speed, disarm the autobrakes. Use manual braking as needed.	

After Landing Procedure

Start the After Landing Procedure when clear of the active runway.

Pilot Flying	Pilot Monitoring
The captain moves or verifies that the SPEEDBRAKE lever is DOWN.	
	Start the APU.
	Set the PROBE HEAT switches to OFF.
	Set the LANDING, TAXI, and STROBE light switches as needed.



737 Flight Crew Operations Manual

Pilot Flying	Pilot Monitoring
	Set the ENGINE START switches to OFF.
Set the weather radar to OFF.	
	Set the AUTOBRAKE selector to OFF.
	Set the flap lever to UP.
	Set the transponder mode selector as needed. At airports where ground tracking is not available, select STANDBY. At airports equipped to track airplanes on the ground, select an active transponder setting, but not a TCAS mode.

Shutdown Procedure

Start the Shutdown Procedure after taxi is complete.

Parking brake Set C

Verify that the parking brake warning light is illuminated.

If towing is not needed:

FASTEN BELTS switch OFF F/O

Electrical power Set F/O

If APU power is needed:

Verify that the APU GENERATOR OFF BUS light is illuminated.

APU GENERATOR bus switches – ON

Verify that the SOURCE OFF lights are extinguished.

If external power is needed:

Verify that the GRD POWER AVAILABLE light is illuminated.

GRD POWER switch – ON

Verify that the SOURCE OFF lights are extinguished.

Engine start levers CUTOFF C

737 Flight Crew Operations Manual

If possible, after high thrust operation, including reverse thrust, run the engines at or near idle for three minutes before shutdown to cool the engine hot sections. Time at or near idle, such as taxiing before shutdown, is applicable to this three minute period. If needed, the engines may be shut down with a one minute cooling period. Routine cool down times of less than three minutes before shutdown are not recommended.

If towing is needed:

Establish communications with ground handling personnel. C

WARNING: If the nose gear steering lockout pin is not installed and hydraulic system A is pressurized, any change to electrical or hydraulic power with the tow bar connected may cause unwanted tow bar movement.

Verify that the nose gear steering lockout pin is installed, or, if the nose gear steering lockout pin is not used. C

System A HYDRAULIC PUMP switches – OFF

Verify that the system A pump LOW PRESSURE lights are illuminated.

CAUTION: Do not hold or turn the nose wheel steering wheel during pushback or towing. This can damage the nose gear or the tow bar.

CAUTION: Do not use airplane brakes to stop the airplane during pushback or towing. This can damage the nose gear or the tow bar.

Set or release the parking brake as directed by ground handling personnel. C

When towing is complete:

FASTEN BELTS switch.....	OFF	F/O
ANTI COLLISION light switch.....	OFF	F/O
FUEL PUMP switches	OFF	F/O

CAUTION: Do not use the center tank fuel pumps with the flight deck unattended.

CAB/UTIL power switch	As needed	F/O
IFE/PASS SEAT power switch	As needed	F/O
WING ANTI-ICE switch	OFF	F/O
ENGINE ANTI-ICE switches	OFF	F/O
ELECTRIC HYDRAULIC PUMP switches	OFF	F/O
YA371 - YA377, YE321 - YE326		
RECIRCULATION FAN switch	As needed	F/O
YC201 - YC207		
RECIRCULATION FAN switches	As needed	F/O
Air conditioning PACK switches	AUTO	F/O
ISOLATION VALVE switch	OPEN	F/O
Engine BLEED air switches	ON	F/O
APU BLEED air switch	ON	F/O
Exterior lights switches	As needed	F/O
FLIGHT DIRECTOR switches	OFF	C, F/O
After the wheel chocks are in place:		
Parking brake – Release.		C
APU switch	As needed	F/O
Call “SHUTDOWN CHECKLIST.”		C
Do the SHUTDOWN checklist.		F/O

Secure Procedure

IRS mode selectors	OFF	F/O
EMERGENCY EXIT LIGHTS switch	OFF	F/O
WINDOW HEAT switches	OFF	F/O
Air conditioning PACK switches	OFF	F/O
Call “SECURE CHECKLIST.”		C



737 Flight Crew Operations Manual

Do the SECURE checklist.

F/O

Intentionally
Blank



Introduction SP.05.1
 General SP.05.1

Airplane General, Emer. Equip., Doors, Windows SP.1.1
 Interior Inspection SP.1.1
 Flight Deck Door Access System Test SP.1.1
 Water System Draining SP.1.2
 Oxygen Mask Microphone Test SP.1.3

Air Systems SP.2.1
 Wing–Body Overheat Test SP.2.1
 External Air Cart Use SP.2.1
 Ground Air Conditioning Cart Use SP.2.2
 Isolated Pack Operation during Engine Start SP.2.2
 Pressurization System Manual Mode Test SP.2.2
 Manual Mode Operation SP.2.3
 During Descent SP.2.4
 Pressurization Control Operation – Landing at Alternate
 Airport SP.2.4
 Automatic Pressurization Control – Landing Airport
 Elevation Above 6000 Feet SP.2.4
 Unpressurized Takeoff and Landing SP.2.4
 Takeoff SP.2.5
 After Takeoff SP.2.5
 Landing SP.2.5
 No Engine Bleed Takeoff and Landing SP.2.5
 Takeoff SP.2.5
 After Takeoff SP.2.6
 Landing SP.2.6

Anti-Ice, Rain	SP.3.1
Anti-Ice Operation	SP.3.1
Cold-Soaked Fuel Frost	SP.3.1
Exterior Safety Inspection - Airplanes with Defined Cold-Soaked Fuel Frost Area	SP.3.1
Exterior Safety Inspection - Airplanes without Defined Cold-Soaked Fuel Frost Area	SP.3.2
Window Heat System Tests	SP.3.4
Overheat Test	SP.3.4
Power Test	SP.3.4
Automatic Flight	SP.4.1
Level Change Climb/Descent	SP.4.1
Vertical Speed (V/S) Climb/Descent	SP.4.1
Temporary Level-Off during Climb or Descent (Not at FMC Cruise Altitude)	SP.4.2
Altitude Hold	SP.4.2
Heading Select	SP.4.2
VOR Navigation	SP.4.2
Instrument Approach using VNAV	SP.4.3
Instrument Approach using Vertical Speed (V/S)	SP.4.5
Circling Approach	SP.4.6
Communications	SP.5.1
Aircraft Communication Addressing and Reporting System (ACARS)	SP.5.1
Pre-Departure Clearance	SP.5.1
Digital-Automatic Information Service	SP.5.1
Oceanic Clearances	SP.5.1
Weight and Balance	SP.5.1
Takeoff Data	SP.5.1
Cockpit Voice Recorder Test	SP.5.2

737 Flight Crew Operations Manual

Electrical	SP.6.1
Electrical Power Up	SP.6.1
Electrical Power Down	SP.6.3
Standby Power Test	SP.6.4
Engines, APU	SP.7.1
Battery Start	SP.7.1
Starting with Ground Air Source (AC electrical power available)	SP.7.4
Engine Crossbleed Start	SP.7.4
Setting N1 Bugs with an Inoperative FMC	SP.7.5
Fire Protection	SP.8.1
Fire and Overheat System Test with an Inoperative Loop	SP.8.1
Flight Controls	SP.9.1
Flight Controls Check	SP.9.1
Flight Instruments, Displays	SP.10.1
Altimeter Difference	SP.10.1
QFE Operation	SP.10.2
Setting Airspeed Bugs with an Inoperative FMC	SP.10.3
Flight Management, Navigation	SP.11.1
Tests	SP.11.1
Transponder Test	SP.11.1
Weather Radar Test	SP.11.1
IRS	SP.11.2
Align Light(s) Flashing	SP.11.2
Fast Realignment	SP.11.3
Inadvertent Selection of Attitude Mode (while on the ground)	SP.11.3
IRS Entries	SP.11.3

Lateral Navigation (LNAV)	SP.11.4
Proceeding Direct to a Waypoint (overwrite)	SP.11.4
Intercepting a Leg (Course) to a Waypoint	SP.11.4
Route Modification	SP.11.5
Route Removal	SP.11.5
Linking a Route Discontinuity	SP.11.5
Determining ETA and Distance to Cross Radial (Bearing) or Distance from a Fix	SP.11.6
Changing Destination	SP.11.6
Entering Holding Fix Into Route	SP.11.6
Exiting Holding Pattern	SP.11.7
Along Track Displacement	SP.11.7
Entering Created Waypoints on the Route or Route Legs Pages	SP.11.8
Entering Created Waypoints on the Nav Data Pages	SP.11.8
Deleting Created Waypoints on the Nav Data Pages	SP.11.9
Entering a Crossing Radial (Bearing) or Distance from a Fix as a Route Waypoint	SP.11.10
Entering a Lateral Offset	SP.11.10
Change SID or Runway	SP.11.11
Change STAR, PROF DES, or APP	SP.11.11
Delete Procedure Turn	SP.11.12
Other Operations	SP.11.12
FMC Navigation Check	SP.11.12
Inhibiting VOR/DME Use for Position Updating	SP.11.13
Inhibiting GPS Updating	SP.11.13
Vertical Navigation (VNAV)	SP.11.14
Temporary Level Off during Climb or Descent (Not at FMC Cruise Altitude)	SP.11.14
Entering Waypoint Speed and Altitude Restriction (On Climb or Descent Legs Only)	SP.11.14
Deleting Waypoint Speed and Altitude Restriction	SP.11.14
Changing Speed and/or Altitude Restriction during Climb or Descent	SP.11.15
Changing Climb/Cruise/Descent Speed Schedule	SP.11.15

737 Flight Crew Operations Manual

Early Descent	SP.11.15
Step Climb or Descent from Cruise	SP.11.15
Performance and Progress Functions	SP.11.16
Determining ETA and Fuel Remaining for New Destination	SP.11.16
Estimated Wind Entries for Cruise Waypoints	SP.11.16
Step Climb Evaluation	SP.11.17
Entering Descent Forecasts	SP.11.17
Engine Out	SP.11.17
Required Time of Arrival (RTA)	SP.11.18
Entering an RTA Waypoint and Time	SP.11.18
Entering Speed Restrictions for RTA Navigation	SP.11.18
Entering New Time Error Tolerances for RTA Navigation	SP.11.18
Additional CDU Functions	SP.11.19
Navigation Display Plan Mode (Center Step Operation)	SP.11.19
Enter Position Shift on Runway	SP.11.19
Fuel	SP.12.1
Fuel Balancing	SP.12.1
Refueling	SP.12.2
Fuel Load Distribution	SP.12.2
Fuel Pressure	SP.12.2
Normal Refueling	SP.12.2
Refueling with Battery Only	SP.12.2
Refueling with No AC or DC Power Source Available	SP.12.2
Ground Transfer of Fuel	SP.12.3
Fuel Crossfeed Valve Check	SP.12.4
Adverse Weather	SP.16.1
Introduction	SP.16.1



Cold Weather Operation	SP.16.1
Exterior Inspection - Captain or First Officer	SP.16.2
Engine Start Procedure	SP.16.3
Before Taxi Procedure	SP.16.3
Taxi-Out	SP.16.5
Exterior De-icing	SP.16.6
Before Takeoff Procedure	SP.16.7
Takeoff Procedure	SP.16.7
Climb and Cruise Procedure	SP.16.7
Approach and Landing	SP.16.10
Taxi-In	SP.16.11
Shutdown Procedure	SP.16.11
Secure Procedure (Airplane Attended)	SP.16.12
Secure Procedure (Airplane Unattended)	SP.16.12
Hot Weather Operation	SP.16.13
Moderate to Heavy Rain	SP.16.14
Turbulence	SP.16.14
Severe Turbulence	SP.16.15
Windshear	SP.16.16
Avoidance	SP.16.16
Precautions	SP.16.16



General

This section contains procedures (adverse weather operation, engine crossbleed start, and so on) that are accomplished as required rather than routinely performed on each flight.

Supplementary procedures may be required because of adverse weather, unscheduled maintenance or as a result of a procedure referenced in a Non-Normal Checklist. Additionally, some may be performed if the flight crew must accomplish preflight actions normally performed by maintenance personnel.

At the discretion of the Captain, procedures may be performed by recall, by reviewing the procedure prior to accomplishment, or by reference to the procedure during its accomplishment.

Supplementary procedures are provided by section. Section titles correspond to the respective chapter title for the system being addressed except for the adverse weather section.



Intentionally
Blank



Interior Inspection

- Emergency exit lights Check
 - Passenger signs Check
 - Service and entry doors Check
 - Escape slides Check pressure
 - Emergency exits Check
 - Wing upper surfaces Check
 - Lavatory fire extinguishers Check
 - Emergency equipment Check
- Check availability and condition of emergency equipment, as required.

Flight Deck Door Access System Test

- Flight deck access system switch NORM
- Flight deck door Open
- Flight deck door lock selector AUTO
- Emergency access code Enter
- ENT key Push
- Verify alert sounds.
- Verify AUTO UNLK light illuminates.
- Flight deck door lock selector DENY
- Verify AUTO UNLK light extinguishes.
- Flight deck door lock selector UNLKD
- Flight deck access system switch OFF

Verify LOCK FAIL light illuminates.

Flight deck access system switch NORM
Guard - Down

Verify LOCK FAIL light extinguishes.

Water System Draining

Lavatory water supply selector valves SUPPLY/DRAIN

Galley water supply shutoff valves SUPPLY ON
The shutoff valve is found adjacent to each wet galley sink.

Drain line Connect to drain ports

There are two drain port locations:

- below the main passenger entry door
- aft of the water service panel

Water service panel Open

Tank drain valve handle OPEN
Drains potable water tank and water system aft of the wings.

Forward lavatory drain valve OPEN
Drain valve is found below the sink in the forward lavatory only.

Drain valves for coffee maker and
water boiler (if installed) OPEN

All galley and lavatory water faucets Open
Close faucets when water flow stops.

Accomplish the following items after verifying the potable water
system is empty:

Drain valves for coffee maker and
water boiler (if installed) CLOSED

Forward lavatory drain valve CLOSED

Tank drain valve handle CLOSED

Water service panel Close

Drain line Disconnect from drain ports

737 Flight Crew Operations Manual

If the potable water tank will not be refilled immediately after the system is emptied, open the following circuit breakers and attach DO-NOT-CLOSE tags:

- P18-3 circuit breaker panel
- LAVATORY WATER HEATER A
 - LAVATORY WATER HEATER D
 - LAVATORY WATER HEATER E

- Power distribution panel number 1
- POT WATER COMPRESSOR
 - WATER QTY IND

Oxygen Mask Microphone Test

MASK-BOOM switch MASK

RESET/TEST Push and hold

EMERGENCY/TEST selector Push and hold

INTERPHONE transmitter selector
and receiver switches Push

Verify oxygen flow sound is heard through the flight deck
loudspeaker.

Push-to-Talk switch I/C

Simultaneously push the Push-to-Talk switch, EMERGENCY/TEST
selector and the RESET/TEST switch.

Verify oxygen flow sound is heard through the flight deck
loudspeaker.

Push-to-Talk switch Release

EMERGENCY/TEST selector Release

RESET/TEST Release

MASK-BOOM switch BOOM

Intentionally
Blank



Wing–Body Overheat Test

Wing–body OVHT TEST switch Push
Hold for a minimum of 5 seconds.

Both WING–BODY OVERHEAT lights – illuminated

MASTER CAUTION – illuminated

AIR COND system annunciator – illuminated

Wing–body OVHT TEST switch Release

Both WING–BODY OVERHEAT lights – extinguished

MASTER CAUTION lights – extinguished

AIR COND system annunciator – extinguished

External Air Cart Use

CAUTION: The BAT switch should always be on when using the airplane air conditioning system since the protective circuits are DC. This ensures protection in the event of loss of AC power.

Note: For engine start with a ground air source, see section SP.7.

APU BLEED air switch OFF

ISOLATION VALVE switch OPEN

YA371 - YA377, YE321 - YE326

RECIRC FAN switch AUTO

YC201 - YC207

RECIRC FAN switches AUTO

YC201 - YC207

Trim Air Switch ON

PACK switches AUTO or HIGH

Cabin temperature selectors AUTO

Set for desired temperature.

Duct pressure 20 psi minimum

If external air cannot hold 20 psi minimum and the APU is operating:

ISOLATION VALVE switch AUTO

APU BLEED air switch ON

APU supplies left pack and external air source supplies right pack.

Ground Air Conditioning Cart Use

Before connecting ground air conditioning cart:

PACK switches OFF

Allows cart to operate at maximum efficiency

After disconnecting ground air conditioning cart:

PACK switches As required

Isolated Pack Operation during Engine Start

To improve cabin air quality between starting the first and second engine:

CAUTION: Moving engine BLEED air switches while a starter is engaged can damage the starter.

Engine No. 2 Start

After engine No. 2 stabilized:

ISOLATION VALVE switch CLOSE

Right PACK switch AUTO

Duct pressure Stabilized

Engine No. 1 Start

After engine No. 1 stabilized:

ISOLATION VALVE switch AUTO

Pressurization System Manual Mode Test

PACK switches OFF

737 Flight Crew Operations Manual

Pressurization mode selector MAN

AUTO FAIL and ALTN lights – extinguished.

MANUAL light – illuminated.

Outflow valve switch CLOSE

Verify outflow valve position indicator moves toward CLOSE.

Outflow valve switch OPEN

Verify outflow valve position indicator moves toward OPEN.

Pressurization mode selector AUTO

Verify outflow valve position indicator moves toward OPEN.

MANUAL light – extinguished.

Manual Mode Operation

CAUTION: Switch actuation to the manual mode causes an immediate response by the outflow valve. Full range of motion of the outflow valve can take up to 20 seconds.

Pressurization mode selector MAN

MANUAL light – illuminated

CABIN/FLIGHT ALTITUDE placard Check

Determine the desired cabin altitude.

If a higher cabin altitude is desired:

Outflow valve switch (momentarily) OPEN

Verify the outflow valve position indicator moves right, cabin altitude climbs at the desired rate, and differential pressure decreases. Repeat as necessary.

If a lower cabin altitude is desired:

Outflow valve switch (momentarily) CLOSE

Verify the outflow valve position indicator moves left, cabin altitude descends at the desired rate, and differential pressure increases. Repeat as necessary.

During Descent

Thrust lever changes should be made as slowly as possible to prevent excessive pressure bumps.

Outflow valve switch (momentarily) CLOSE

During descent, intermittently position the outflow valve switch toward CLOSE, observing cabin altitude decrease as the airplane descends.

Before entering the landing pattern, slowly position the outflow valve switch to full open to depressurize the airplane. Verify differential pressure is zero.

Pressurization Control Operation – Landing at Alternate Airport

At top of descent:

LAND ALT Indicator Reset
Reset to new destination field elevation.

Automatic Pressurization Control – Landing Airport Elevation Above 6000 Feet

If flight is less than one hour:

Accomplish Normal Procedures.

If flight is more than one hour:

Accomplish Normal Procedures except as modified below.

Prior to takeoff:

LAND ALT indicator 6000 feet

At initial descent or approximately 20 minutes prior to landing:

LAND ALT indicator Destination field elevation

Unpressurized Takeoff and Landing

When making a no engine bleed takeoff or landing with the APU inoperative:

Takeoff

PACK switches AUTO
ISOLATION VALVE switch CLOSE
Engine BLEED air switches OFF

After Takeoff

Note: If engine failure occurs, do not position engine BLEED air switches ON until reaching 1500 feet or until obstacle clearance height has been attained.

At not less than 400 feet, and prior to 2000 feet above field elevation:

Engine No. 2 BLEED air switch ON

When CABIN rate of CLIMB indicator stabilizes:

Engine No. 1 BLEED air switch ON

ISOLATION VALVE switch AUTO

Landing

When below 10,000 feet and starting final approach turn:

Engine BLEED air switches OFF

Avoid high rates of descent for passenger comfort.

No Engine Bleed Takeoff and Landing

When making a no engine bleed takeoff or landing with the APU operating.

Takeoff

Note: If anti-ice is required for taxi, configure for a “No Engine Bleed Takeoff” just prior to take-off.

Note: If anti-ice is not required for taxi, configure for a “No Engine Bleed Takeoff” just after engine start.

Right PACK switch AUTO

ISOLATION VALVE switch CLOSE

Left PACK switch AUTO

Engine No. 1 BLEED air switch	OFF
APU BLEED air switch	ON
Engine No. 2 BLEED air switch	OFF
YC201 - YC207	
Trim Air Switch	ON
WING ANTI-ICE switch	OFF

The WING ANTI-ICE switch must remain OFF until the engine BLEED air switches are repositioned to ON and the ISOLATION VALVE switch is repositioned to AUTO.

After Takeoff

Note: If engine failure occurs, do not position engine BLEED air switches ON until reaching 1500 feet or until obstacle clearance height has been attained.

Engine No. 2 BLEED air switch	ON
APU BLEED air switch	OFF
When CABIN rate of CLIMB indicator stabilizes:	
Engine No. 1 BLEED air switch	ON
ISOLATION VALVE switch	AUTO

Landing

If additional go-around thrust is desired, configure for a “No Engine Bleed Landing.”

When below 10,000 feet:

WING ANTI-ICE switch	OFF
Right PACK switch	AUTO
ISOLATION VALVE switch	CLOSE
Left PACK switch	AUTO
Engine No. 1 BLEED air switch	OFF
APU BLEED air switch	ON
Engine No. 2 BLEED air switch	OFF



Anti-Ice Operation

Requirements for use of anti-ice and operational procedures for engine and wing anti-ice are contained in Supplementary Procedures, Adverse Weather Section SP.16.

Cold-Soaked Fuel Frost

Frost may form on the lower and upper wing surfaces due to cold-soaked fuel touching the wing surface after long flights with large fuel loads.

Exterior Safety Inspection - Airplanes with Defined Cold-Soaked Fuel Frost Area

Note: The presence of the painted cold soaked fuel frost area on the upper wing and the inclusion of these procedures in the FCOM do not constitute operational approval. Operators may be allowed to use these procedures by referring to the appropriate regulatory authority for approval or exemption, as required, to implement the procedure.

Surfaces..... Check

Visually inspect the lower and upper wing surfaces.

If there is frost or ice on the lower surface outboard of measuring stick 4, there may also be frost or ice on the upper surface. The distance that the frost extends outboard of measuring stick 4 can be used as an indication of the extent of the frost on the upper surface.

Takeoff with light coatings of cold-soaked fuel frost, up to 1/8 inch (3 mm) in thickness on lower wing surfaces is allowable; however, all leading edge devices, all control surfaces, tab surfaces and balance panel cavities must be free of snow, frost or ice. If the frost on the lower surface is greater than 1/8 inch (3 mm) in thickness, all ice or frost on the wings must be removed using appropriate deicing/anti-icing procedures.

Takeoff with light coatings of cold-soaked fuel frost on upper wing surfaces is allowable, provided the following conditions are met:

- the frost on the upper surface is less than 1/16 inch (1.5 mm) in thickness

- the extent of the frost is similar on both wings
- the frost is on or between the black lines defining the allowable cold-soaked fuel frost area (see figure) with no ice or frost on the leading edges or control surfaces
- the ambient air temperature is above freezing (0°C, 32°F)
- there is no precipitation or visible moisture (rain, snow, drizzle or fog with less than 1 mile visibility, etc.)

If all the above criteria are not met, all ice or frost on the wings must be removed using appropriate deicing/anti-icing procedures.

Note: If the frost on the lower surface is less than 1/16 inch (1.5 mm) in thickness, the frost on the upper surface will be less than 1/16 inch (1.5 mm) in thickness.

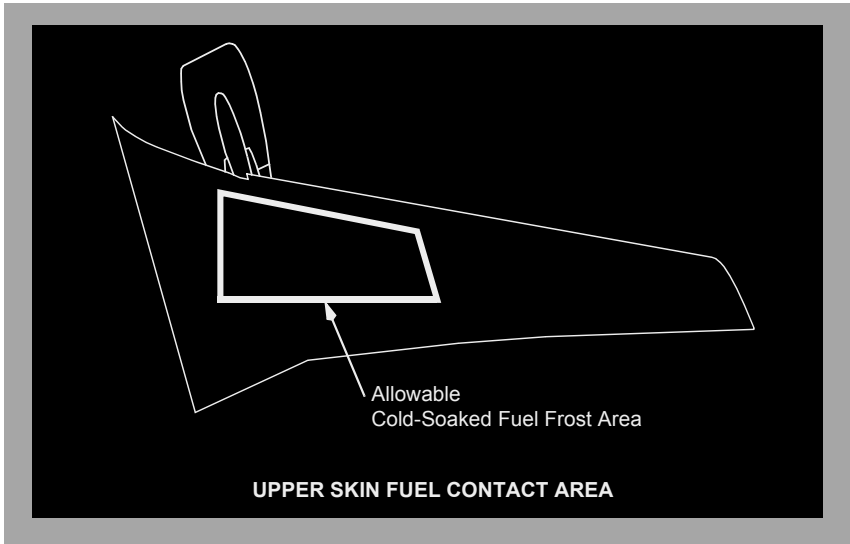

Exterior Safety Inspection - Airplanes without Defined Cold-Soaked Fuel Frost Area

Surfaces Check

Visually inspect the lower and upper wing surfaces.

If there is frost or ice on the lower surface outboard of measuring stick 4, there may also be frost or ice on the upper surface. The distance that the frost extends outboard of measuring stick 4 can be used as an indication of the extent of the frost on the upper surface.

737 Flight Crew Operations Manual

Takeoff with light coatings of cold-soaked fuel frost, up to 1/8 inch (3 mm) in thickness on lower wing surfaces is allowable; however, all leading edge devices, all control surfaces, tab surfaces and balance panel cavities must be free of snow, frost or ice. If the frost on the lower surface is greater than 1/8 inch (3 mm) in thickness, all ice or frost on the wings must be removed using appropriate deicing/anti-icing procedures.

Takeoff with cold-soaked fuel frost on upper wing surfaces is not allowable. If any frost is present on the upper wing surface, all ice or frost on the wings must be removed using appropriate deicing/anti-icing procedures.

Window Heat System Tests

Overheat Test

The overheat test simulates an overheat condition to check the overheat warning function of the window heat system.

WINDOW HEAT switches ON

WINDOW HEAT TEST switch OVHT

OVERHEAT lights – On

ON lights – Extinguish

Lights extinguish after approximately 1 minute.

MASTER CAUTION – On

ANTI-ICE system annunciator – On

WINDOW HEAT switches Reset

Position the WINDOW HEAT switches OFF, then ON.

Power Test

The power test verifies operation of the window heat system. The test may be accomplished when any of the window heat ON lights are extinguished and the associated WINDOW HEAT switch is ON.

WINDOW HEAT switches ON

Note: Do not perform the power test when all ON lights are illuminated

WINDOW HEAT TEST switch PWR

The controller is forced to full power, bypassing normal temperature control. Overheat protection is still available.

WINDOW HEAT ON lights Illuminated

If any ON light remains extinguished, the window heat system is inoperative. Observe the maximum airspeed limit of 250 kts below 10,000 feet.



Level Change Climb/Descent

ALTITUDE selector Set desired altitude

Note: If a new MCP altitude is selected while in ALT ACQ, the AFDS engages in V/S and the existing vertical speed is maintained.

LVL CHG switch Push

Verify FMA display:

Thrust mode (climb) – N1

Thrust mode (descent) – RETARD then ARM

Pitch mode – MCP SPD

IAS/MACH Selector Set desired speed

Vertical Speed (V/S) Climb/Descent

ALTITUDE selector Set desired altitude

Note: If a new MCP altitude is selected while in ALT ACQ, the AFDS engages in V/S and the existing vertical speed is maintained.

V/S thumbwheel Set desired vertical speed

Verify FMA display:

Thrust mode (climb or descent) – MCP SPD

Pitch mode – V/S

IAS/MACH Selector Set desired speed

To transition to the vertical speed mode from another engaged climb or descent mode:

V/S mode switch Push

V/S climb mode engages at existing V/S.

V/S thumbwheel Set desired vertical speed

Verify FMA display:

Thrust mode (climb or descent) – MCP SPD

Pitch mode – V/S

IAS/MACH Selector Set desired speed

Temporary Level-Off during Climb or Descent (Not at FMC Cruise Altitude)

MCP altitude selectorSet desired altitude

MCP N1 light will extinguish if leveling from a climb.

N1 Limit changes to CRZ if leveling from a climb.

To continue climb/descent:

MCP altitude selectorSet desired altitude

VNAV switch Push

Observe climb or descent initiated. Mode annunciations appear as initial climb or descent.

Altitude Hold

Altitude HOLD switch Push

Verify FMA display:

Pitch mode – ALT HOLD

Heading Select

Heading selectorSet desired heading

Heading select switch Push

Verify FMA display:

Roll mode – HDG SEL

VOR Navigation

VHF NAV radio(s)Tune and Identify

COURSE selectorSet desired course

When on an intercept heading to the VOR course:

VOR LOC mode switch Push

Verify VOR LOC armed mode annunciates.

A/P automatically captures the VOR course.

Verify VOR LOC engaged mode annunciates upon course capture.

Note: If change to a localizer frequency is desired when captured in the VOR mode, disengage VOR LOC mode prior to selection of the localizer. VOR LOC mode can then be reengaged.

Instrument Approach using VNAV

Note: This procedure is not authorized using QFE.

Note: Operational approval required for the use of an MDA(H) as a DA(H). If required to remain at or above MDA(H) during the missed approach, a missed approach must be initiated at least 50 feet above MDA(H).

Recommended roll modes for final approach:

- RNAV, GPS or TACAN approach: LNAV
- LOC-BC, VOR or NDB approach: LNAV or HDG SEL
- LOC, SDF or LDA approach: VOR/LOC or LNAV.

For LOC, LOC-BC, SDF or LDA approaches, ensure appropriate navaids are tuned and identified prior to commencing the approach and monitor raw data throughout the approach. For VOR and NDB approaches, raw data should be monitored, if available.

FMC approach procedure Select

Select the approach procedure on the ARRIVALS page. Do not manually build the approach or add waypoints to the selected FMC procedure. Add cold temperature corrections to waypoint altitude constraints as appropriate.

Verify VNAV glide path angle is displayed on the final approach segment of the LEGS page.

RNP appropriate for approach (if required) Verify/Enter
[Allows appropriate alerting to occur if ANP exceeds RNP.]

Approximately 2 NM prior to the FAF and after ALT HLD or VNAV PTH is engaged:

MCP altitude Set MDA(H)/DA(H)

[Allows VNAV to command descent in VNAV PTH. If the MDA(H)/DA(H) does not end in zero zero, for example, 1820, set MCP ALTITUDE window to the closest 100 foot increment above the constraint.]

Note: There may be a level segment beyond the FAF before intercepting the descent path.

Prior to reaching FAF:

AFDS roll mode Verify/select

Verify appropriate roll mode annunciates.

VNAV switch (if required) Push

Select VNAV if in ALT HLD. Verify VNAV PTH annunciates.

Autopilot Verify engaged

[Autopilot should remain engaged until suitable visual reference is established.]

Prior to reaching MDA(H)/DA(H) and when the airplane is at least 300 feet below the missed approach altitude:

MCP altitude Set missed approach altitude

At MDA(H)/DA(H)/Missed approach point:

If suitable visual reference is not established, execute a missed approach.

After suitable visual reference is established:

A/P disengage switch Push

Disengage the autopilot before descending below MDA(H)/DA(H).

A/T disengage switch Push

Disengage the autothrottle before descending below MDA(H)/DA(H).

Instrument Approach using Vertical Speed (V/S)

Note: Autopilot use is recommended until suitable visual reference is established.

Note: If required to remain at or above the MDA during the missed approach, the missed approach must be initiated at least 50 feet above MDA.

Recommended roll modes:

- RNAV, GPS, TACAN, LOC-BC, VOR or NDB approach: LNAV or HDG SEL.
- LOC, SDF or LDA approach: LOC or LNAV.

Ensure appropriate nav aids (VOR, LOC or NDB) are tuned and identified prior to commencing approach.

RNP appropriate for approach (if required) Verify/Enter
Allows appropriate alerting to occur if ANP exceeds RNP.

Before descent to MDA(H):

MCP altitude Set

Set the first intermediate altitude constraint or the MDA(H).
When the current constraint is assured, the next constraint may be set prior to ALT HOLD is engaged to achieve continuous descent path.

If constraints or MDA(H) do not end in zero zero, for example, 1820, set MCP ALTITUDE window to the closest 100 foot increment above the constraint.

At descent point:

Desired V/S Set

Set desired V/S to descend to MDA(H). Use a V/S that results in no level flight segment at the MDA(H).

Verify V/S mode annunciates.

Approaching MDA(H):

MCP altitude Set missed approach altitude

At MDA(H)/missed approach point:

If suitable visual reference is not established, execute a missed approach.

After a suitable visual reference is established:

A/P disengage switch Push
Disengage the autopilot before descending below
MDA(H).

A/T disengage switch Push
Disengage the autothrottle before descending below
MDA(H).

Circling Approach

Note: Autopilot use is recommended until intercepting the landing profile.

MCP altitude selector Set

If the MDA(H) does not end in zero zero, for example, 1820, set MCP ALTITUDE window to the closest 100 foot increment above the MDA(H).

Accomplish an instrument approach, establish suitable visual reference and level off at MCP altitude.

Verify ALT HLD mode annunciates.

MCP altitude selector Set missed approach altitude

HDG SEL switch Push

Verify HDG SEL mode annunciates.

Intercepting the landing profile:

Autopilot disengage switch Push

Autothrottle disengage switch Push

**Aircraft Communication Addressing and Reporting System
(ACARS)**

The following procedures are applicable to the noted ACARS functions from the company pages.

Pre-Departure Clearance

The flight crew shall manually verify (compare) the filed flight plan versus the digital pre-departure clearance and shall initiate voice contact with Air Traffic Control if any question/confusion exists between the filed flight plan and the digital pre-departure clearance.

Digital-Automatic Information Service

The flight crew shall verify that the D-ATIS altimeter setting numeric value and alpha value are identical. If the D-ATIS altimeter setting numeric value and alpha values are different, the flight crew must not accept the D-ATIS altimeter setting.

Oceanic Clearances

The flight crew shall manually verify (compare) the filed flight plan versus the digital oceanic clearance and initiate voice contact with Air Traffic Control if any questions/confusion exists between the filed flight plan and the digital oceanic clearance.

Weight and Balance

The flight crew shall verify the Weight and Balance numeric and alphabetical values are identical. If the Weight and Balance numeric and alphabetical values are different, the flight crew must not accept the Weight and Balance data.

Takeoff Data

The flight crew shall verify the Takeoff Data numeric and alphabetic values are identical. If the Takeoff Data numeric and alphabetic values are different, the flight crew must not accept the Takeoff Data message.



Cockpit Voice Recorder Test

Note: The Cockpit VOICE RECORDER switch must be in the ON position or at least one engine must be operating to perform this test.

Test switch Push

After a slight delay:

Test light ON

A tone may be heard through a headset plugged into the headset jack.

Test switch Release



Electrical Power Up

The following procedure is accomplished to permit safe application of electrical power.

BATTERY switch Guard closed
YA371, YA372, YC201

Note: Do not move the airplane until Integrated Standby Flight Display (ISFD) alignment is complete.

STANDBY POWER switch Guard closed

Verify that the STANDBY PWR OFF light is extinguished.

ALTERNATE FLAPS master switch Guard closed

Windshield WIPER selector(s) PARK

ELECTRIC HYDRAULIC PUMPS switches OFF

LANDING GEAR lever DN

Verify that the green landing gear indicator lights are illuminated.

Verify that the red landing gear indicator lights are extinguished.

WEATHER RADAR Off

If external power is needed:

Verify that the GRD POWER AVAILABLE light is illuminated.

GRD POWER switch – ON

Verify that the SOURCE OFF lights are extinguished.

Verify that the TRANSFER BUS OFF lights are extinguished.

If APU power is needed:

Verify that the engine No. 1, APU and the engine No. 2 fire switches are in.

Alert ground personnel before the following test is accomplished.

OVERHEAT DETECTOR switches – NORMAL

TEST switch – Hold to FAULT/INOP

Verify that the MASTER CAUTION lights are illuminated.

Verify that the OVHT/DET annunciator is illuminated.

Verify that the FAULT light is illuminated.

If the FAULT light fails to illuminate, the fault monitoring system is inoperative.

Verify that the APU DET INOP light is illuminated.

Do not operate the APU if the APU DET INOP light fails to illuminate.

TEST switch – Hold to OVHT/FIRE

Verify that the fire warning bell sounds.

Verify that the master FIRE WARN lights are illuminated.

Verify that the MASTER CAUTION lights are illuminated.

Verify that the OVHT/DET annunciator is illuminated.

Master FIRE WARN light – Push

Verify that the master FIRE WARN lights are extinguished.

Verify that the fire warning bell cancels.

Verify that the engine No. 1, APU and the engine No. 2 fire switches stay illuminated.

Verify that the ENG 1 OVERHEAT and ENG 2 OVERHEAT lights stay illuminated.

EXTINGUISHER TEST switch – Check

TEST Switch - Position to 1 and hold

Verify that the three green extinguisher test lights are illuminated.

TEST Switch - Release

Verify that the three green extinguisher test lights are extinguished.

Repeat for test position 2.

737 Flight Crew Operations Manual

APU - Start and on bus

When the APU GEN OFF BUS light is illuminated:

APU GENERATOR bus switches - ON

Verify that the SOURCE OFF lights are extinguished.

Verify that the TRANSFER BUS OFF lights are extinguished.

Verify that the APU MAINT light is extinguished.

Verify that the APU LOW OIL PRESSURE light is extinguished.

Verify that the APU FAULT light is extinguished.

Verify that the APU OVERSPEED light is extinguished.

Wheel well fire warning system Test

Test switch – Hold to OVHT/FIRE

Verify fire warning bell sounds, master FIRE WARN lights, MASTER CAUTION lights and OVHT/DET annunciator illuminate.

Fire warning BELL CUTOFF switch – Push

Verify that the master FIRE WARN lights extinguish.

Verify that the fire warning bell cancels.

Verify that the WHEEL WELL fire warning light is illuminated.

Electrical Power Down

This procedure assumes the Secure procedure is complete.

APU switch and/or GRD POWER switch OFF

If APU was operating:

Delay approximately 2 minutes after the APU GEN OFF BUS light extinguishes before placing the BATTERY switch OFF.

BATTERY switch OFF

Standby Power Test

Battery switch ON

AC–DC meter selectors..... STBY PWR

If APU generator is on–line:

APU GEN No. 1 switch OFF

APU GEN No. 2 switch OFF

If ground power is on–line:

GRD PWR switch OFF

STANDBY POWER switch OFF

Check STANDBY PWR OFF light illuminated.

AC–DC voltmeters Zero

STANDBY POWER switch BAT

Check STANDBY PWR OFF Light extinguished.

AC–DC voltmeters Check

AC voltmeter 115 +/-5 volts

DC voltmeter 24 +/-2 volts

Frequency meter Check

Check frequency meter for normal indication: 400 +/- 10 CPS.

DC meter selector BAT

Check DC voltmeter for normal indication: 24 +/- 2 volts.

Check DC ammeter for discharge indication: a negative value.

DC meter selector AUX BAT

Check DC voltmeter for normal indication: 24 +/- 2 volts.

Check DC ammeter for discharge indication: a negative value.

STANDBY POWER switch AUTO

GRD PWR switch or APU GEN No. 1 and No. 2 switches ON

Note: It may take up to 3 minutes for CDS displays to recover when power is interrupted for more than 2 seconds on the ground.



Battery Start

(With APU bleed or ground air available)

Maintenance documents Check

FLIGHT DECK ACCESS SYSTEM

switch Guard closed

BATTERY switch Guard closed

YA371, YA372, YC201

Note: Do not move the airplane until ISFD alignment is complete.

ELECTRIC HYDRAULIC PUMPS

switches OFF

LANDING GEAR lever DN

Verify that the green landing gear indicator lights are illuminated.

Verify that the red landing gear indicator lights are extinguished.

FLAP lever Set

Position the flap lever to agree with the flap position.

APU (bleed air source if available) Start

Flap Lever Set

Position the FLAP lever to agree with the FLAPS position indicator.

Emergency equipment Check

Fire extinguisher - Checked and stowed

Crash axe - Stowed

Escape ropes - Stowed

Other needed equipment - Checked and stowed.

Flight recorder switch Guard closed

Circuit breakers Check

Accomplish the Interior and Exterior Inspection if required, except for items requiring electrical or hydraulic power.

Accomplish the following Preflight Procedure - First Officer items:

Overheat and fire protection panel Check

TEST switch - Hold to FAULT/INOP

TEST switch - Hold to OVHT/FIRE

EXTINGUISHER TEST switch - Check

APU switch

(bleed air source, if available) START

On the captain's command, the first officer reads and the captain does the following items:

Oxygen Test and set

CAB/UTIL power switch ON

IFE/PASS seat power switch ON

EMERGENCY EXIT LIGHTS switch Guard closed

Passenger signs Set

HYDRAULIC PUMP switches ON

Air conditioning panel Set

APU BLEED air switch - ON

PACK switches - AUTO or HIGH

Engine BLEED air switches - ON

Parking brake Set

Note: The wheels should be chocked in case the brake pressure has bled down.

Papers Aboard

When cleared for Engine Start, do the following:

Air conditioning PACK switches OFF

ANTICOLLISION light switch ON

737 Flight Crew Operations Manual

Ignition select switch IGN-R

Engine Start

Engine No. 1 start Accomplish
Only N1, N2, and oil quantity are displayed until the EEC's are
powered.

Generator 1 switch ON

IRS mode selectors OFF, then NAV

Verify that the ON DC lights illuminate, then extinguish

Verify that the ALIGN lights are illuminated.

FMC/CDU Set IRS position

WARNING: If engine No. 1 was started using a ground air source, to minimize the hazard to ground personnel, the external air should be disconnected and engine No. 2 started using the Engine Crossbleed Start procedure.

Engine No. 2 start Accomplish

Generator 2 switch ON

Complete the Preliminary Preflight Procedure - Captain or First Officer
by doing the following items:

PSEU light Verify extinguished

GPS light Verify extinguished

SERVICE INTERPHONE switch OFF

ENGINE panel Set

Verify that the REVERSER lights are extinguished

Verify that the ENGINE CONTROL lights are extinguished

EEC switches - ALTN then ON

Oxygen panel Set

CREW OXYGEN pressure indicator - Check



Verify that the pressure meets dispatch requirements.

Note: PASSENGER OXYGEN switch activation causes deployment of the passenger oxygen masks.

PASSENGER OXYGEN switch - Guard closed

Verify that the PASS OXY ON light is extinguished.

Landing gear indicator lights Verify illuminated

Manual gear extension access door Closed

Accomplish the CDU Preflight Procedure, Preflight Procedure - First Officer and Preflight Procedure - Captain to ensure that the flight deck preparation procedure is complete.

BEFORE TAXI checklist Accomplish

IRS alignment Complete

**Starting with Ground Air Source
(AC electrical power available)**

Engine No. 1 must be started first.

When cleared to start:

APU BLEED air switch OFF

Engine No. 1 start Accomplish

Use normal start procedures.

WARNING: To minimize the hazard to ground personnel, the external air should be disconnected, and engine No. 2 started using the Engine Crossbleed Start procedure.

Engine Crossbleed Start

Prior to using this procedure, ensure that the area to the rear is clear.

Engine BLEED air switches ON

APU BLEED air switch OFF

PACK switches OFF

737 Flight Crew Operations Manual

ISOLATION VALVE switch AUTO

Ensures bleed air supply for engine start.

Engine thrust lever
(operating engine) Advance thrust lever until bleed
duct pressure indicates 30 PSI

Non-operating engine Start

Use normal start procedures with crossbleed air.

After starter cutout, adjust thrust on both engines, as required.

Setting N1 Bugs with an Inoperative FMC

Reference the Performance – Inflight section to determine N1 setting
for desired phase of flight.

N1 SET outer knob BOTH

The last FMC computed value is displayed by reference N1 bugs
and readouts. If the FMC has not calculated an input since power up,
a default value of 104% is displayed.

N1 SET inner knob Set N1

Note: If the N1 SET outer knob is returned to the AUTO position, the
bugs and readouts will revert to the last FMC computed value or
104% if the FMC has not calculated an input since power up.

Intentionally
Blank



Fire and Overheat System Test with an Inoperative Loop

To determine the specific inoperative loop:

OVHT DET switches A

Test switch OVHT/FIRE

If the FAULT light remains extinguished and both ENG OVERHEAT lights and engine fire warning switches illuminate, loop A is good.

If the FAULT light illuminates and one of the ENG OVERHEAT lights and corresponding engine fire warning switch remain extinguished, there is a fault in loop A of the detection system of that engine.

OVHT DET switches B

Test switch OVHT/FIRE

If the FAULT light remains extinguished and both ENG OVERHEAT lights and engine fire warning switches illuminate, loop B is good.

If the FAULT light illuminates and one of the ENG OVERHEAT lights and corresponding engine fire warning switch remain extinguished, there is a fault in loop B of the detection system of that engine.

OVHT DET switches As required

Select the good loop for each engine (NORMAL if both loops tested good).

Test switch OVHT/FIRE

If the test is successful leave the fire panel in this configuration for flight.



Intentionally
Blank

**Flight Controls Check**

This is a check of normal flight control functions and is not a complete check of the flight control system. Two people are required; both on interphone.

FLIGHT DECK ACTION	GROUND RESPONSE
Electrical power (APU or external) – On bus	
System A and B electric hydraulic pump switches – OFF	
Control wheel – Left	“LEFT AILERON UP, TAB DOWN; RIGHT AILERON DOWN, TAB UP”
Control wheel – Right	“LEFT AILERON DOWN, TAB UP; RIGHT AILERON UP, TAB DOWN”
Control wheel – Neutral	
Control column – Forward	“ELEVATOR DOWN, TABS UP”
Control column – Aft	“ELEVATOR UP, TABS DOWN”
Control column – Neutral	
Request hydraulic clearance	“CLEAR FOR HYDRAULIC PRESSURE, WING AND CONTROL AREAS CLEAR”
System A and B electric hydraulic pump switches – ON Verify System A & B pressure indicators and brake pressure indicator read 2800 psi minimum	
Parking brake – Set	

FLIGHT DECK ACTION	GROUND RESPONSE
Rudder trim – Turn left Verify left rudder pedals move forward	
Rudder trim – Turn right Verify right rudder pedals move forward	
Rudder trim – Zero, pedals centered	
Aileron trim – Turn left Verify control wheel turns to left	
Aileron trim – Turn right Verify control wheel turns to right	
Aileron trim – Zero, control wheels centered	
Flap lever – UP Verify flap position indicator reads zero	
Nose gear steering wheel – Hold Control wheel – Left Control column – Forward Rudder pedal – Left	“LEFT AILERON UP, TAB DOWN; LEFT FLIGHT SPOILERS UP; RIGHT AILERON DOWN, TAB UP; RUDDER LEFT; ELEVATORS DOWN, TABS UP”
Nose gear steering wheel – Hold Control wheel – Right Control column – Aft Rudder pedal – Right	“LEFT AILERON DOWN, TAB UP; RIGHT FLIGHT SPOILERS UP; RIGHT AILERON UP, TAB DOWN; RUDDER RIGHT; ELEVATORS UP, TABS DOWN”
Flight controls – Neutral	
Alternate flaps master switch – ARM	

737 Flight Crew Operations Manual

FLIGHT DECK ACTION	GROUND RESPONSE
Flap lever – Position 1 Verify no flap movement	
Alternate flaps position switch – hold DOWN until flap position indicator indicates 1	“FLAPS MOVING DOWN”
Flap position indicator – flaps 1 Verify aft overhead leading edge devices annunciator panel indicates all green (FULL EXTEND) with no amber lights illuminated. Verify LE FLAPS TRANSIT light remains illuminated	“ALL LEADING EDGE DEVICES FULLY EXTENDED”
Alternate flaps master switch – OFF Verify Aft overhead leading edge devices annunciator panel indicates all leading edge flaps full extended and all leading edge slats in extend position Verify LE FLAPS EXT light illuminated	“LEADING EDGE FLAPS FULLY EXTENDED, ALL LEADING EDGE SLATS RETRACTED TO EXTEND POSITION”
Speed brake lever – UP	“ALL SPOILERS UP”
Speed brake lever – DOWN	“ALL SPOILERS DOWN”
Stabilizer trim switches – NOSE DOWN	“STABILIZER LEADING EDGE MOVING UP”
Stabilizer trim switches – NOSE UP	“STABILIZER LEADING EDGE MOVING DOWN”
With stabilizer still moving: Stabilizer trim cutout switches – CUTOUT Verify trim motor stops	



737 Flight Crew Operations Manual

FLIGHT DECK ACTION	GROUND RESPONSE
Stabilizer trim cutout switches – NORMAL Verify Trim motor resumes Control column – Forward Verify Trim motor stops Column actuated stab trim override – OVERRIDE Verify Trim motor resumes	
Stabilizer trim switches – Trim into green band	
Column actuated stab trim override – NORMAL Switch guard – Close	
Request clearance to flaps 30	“FLAPS CLEAR”
Flap lever – Position 30	“FLAPS MOVING DOWN”
Control column – Forward	“ELEVATOR DOWN, TABS DOWN”
Control column – Aft	“ELEVATOR UP, TABS UP”
Control column – Neutral	
Flap lever – UP	“FLAPS MOVING UP”
Parking Brake – As desired Electrical power – As desired	



Altimeter Difference

Note: If flight in RVSM airspace is planned use the RVSM table in the limitations section.

This procedure is accomplished when there is a noticeable difference between the altimeters. Accomplish this procedure in stabilized level flight or on the ground.

Altimeter barometric settings Check
Check all altimeters set to proper barometric setting for phase of flight.

Standby altimeter baro set control Rotate and reset
Rotate to a different setting, then reset proper barometric setting.

Altimeters Crosscheck
Maximum differences between the altimeter readings:

Altitude	CDS/CDS	CDS/Standby
Sea Level	50 feet	50 feet
5,000 feet	50 feet	80 feet
10,000 feet	60 feet	120 feet
15,000 feet	70 feet	(see note)
20,000 feet	80 feet	(see note)
25,000 feet	100 feet	(see note)
30,000 feet	120 feet	(see note)
35,000 feet	140 feet	(see note)
40,000 feet	160 feet	(see note)
41,000 feet	170 feet	(see note)

Note: Above 10,000 feet and 0.4 Mach, position error causes the tolerance to diverge rapidly and direct crosscheck becomes inconclusive. Differences greater than 400 feet should be suspect and verified by ground maintenance checks.

If it is not possible to identify which altimeter is indicating the correct altitude:

ATCNotify

QFE Operation

This procedure is accomplished when ATC altitude assignments are referenced to QFE altimeter settings.

Note: Do not use LNAV or VNAV below transition altitude/level.
Altitudes in the navigation data base are not referenced to QFE.
Use only raw data for navigation.

YA375 - YA377, YC207

FMC/CDU APPROACH REFERENCE page
or TAKEOFF REFERENCE page 2/2 Select

LANDING REF line select key Push

Verify QFE selected.

[This sets the landing altitude to zero.]

Altimeters Set

Set altimeters to QFE when below transition altitude/level.

Note: If QFE altimeter setting is beyond the range of the altimeters,
QNH procedures must be used with QNH set in the altimeters.

Landing altitude indicator Set at zero

Setting Airspeed Bugs with an Inoperative FMC

To set reference airspeed bugs for takeoff:

Speed reference selector (outer) V1

Default speed of 80 knots is displayed.

Speed reference selector (inner) Set V1 speed

V1 bug is displayed when a speed greater than 80 knots is set.

The NO VSPD flag is displayed until both V1 and VR are set.

Speed reference selector (outer) VR

Default speed of 80 knots is displayed.

Speed reference selector (inner) Set VR speed

VR bug is displayed when a speed greater than 80 knots is set.

The NO VSPD flag is removed after both V1 and VR are set.

MCP speed selector Set V2

Airspeed cursor and V2+15 bug move to the correct speeds.

Speed reference selector (outer) WT

Default weight of 32,000 kgs is displayed.

Speed reference selector (inner) Set takeoff gross weight

Flaps up maneuver speed bug is displayed.

Note: If VREF is selected on the ground, INVALID ENTRY is displayed.

To set the spare bug, if desired:

Speed Reference selector (outer) Spare bug

Default speed of 60 knots is displayed.

Speed reference selector (inner) Set

Set speed as desired.

Speed reference selector (outer) SET

Digital readout is removed.

Note: When the flap lever is set to any takeoff flap setting above flaps 1, a bug comes into view for the next smaller flap maneuvering speed, between takeoff flaps and flaps up. For example, if the flap lever is set to 15 for takeoff, a bug for flaps 5 maneuvering speed will appear. For a flaps 1 takeoff, the flaps 1 maneuvering speed will be displayed.

To set reference airspeed bugs for approach:

Speed reference selector (outer) WT

Default weight of 32,000 kgs is displayed.

Speed reference selector (inner) Set current gross weight

Flaps up maneuver speed bug is displayed.

Speed reference selector (outer) VREF

Default speed of 80 knots is displayed.

Speed reference selector (inner) Set VREF speed

YA371 - YC206, YE321 - YE326

The green VREF bug and white VREF +15 bug are shown when a speed greater than 80 knots is set.

YC207

The green VREF bug and white VREF +20 bug are shown when a speed greater than 80 knots is set.

Note: If V1 or VR is selected in flight, INVALID ENTRY is displayed.

To set the spare bug, if desired:

Speed reference selector (outer) Spare bug

Default speed of 60 knots is displayed.

Speed reference selector (inner) Set

Set speed as desired.

Speed reference selector (outer) SET

Digital readout is removed.



Tests

Transponder Test

Transponder mode selector TEST

Check fail light illuminates.

Check all code segments illuminate. Verify no error codes exist.

Verify aural indicates TCAS system test passed.

Note: TCAS TEST is displayed on the navigation display during the test followed by TCAS TEST PASSED or TCAS TEST FAILED. This test remains in view for 8 seconds then blanks. An aural annunciation sounds at the completion of the test.

AURAL ALERTS	DEFINITION
“TCAS SYSTEM TEST FAIL”	Test failed. Maintenance required.
“TCAS SYSTEM TEST PASSED”	Test complete. System operable.

Weather Radar Test

EFIS mode selector MAP, MAP CTR, VOR, or APP

Weather Radar Mode TEST

STAB ON

WXR (EFIS control panel) ON

Verify test pattern consisting of the following colors appears:

- Green
- Yellow
- Red
- Magenta.

If testing of the PWS system is desired:

Weather Radar Mode Deselect TEST

WXR (EFIS control panel) ON

Weather Radar Mode TEST

Verify the amber WINDSHEAR caution, red WINDSHEAR warning and PWS FAIL annunciations display momentarily and then extinguish.

Note: In the short time the weather radar is on and not in the TEST position, it will radiate.

IRS

Align Light(s) Flashing

Do not move IRS Mode selector to OFF except where called for in procedure.

POS INIT page Select

Set IRS position Enter present position

Enter present position using the most accurate latitude and longitude available. If the present position is being entered via the CDU and a position is already displayed on the SET IRS POS line, enter new position over displayed position.

If ALIGN light continues to flash:

Set IRS position Enter present position

Re-enter same present position.

If ALIGN light continues to flash after re-entry:

IRS OFF

Rotate IRS Mode Selector to OFF and verify ALIGN light extinguished.

Note: Light must be extinguished before continuing with procedure (approximately 30 seconds.)

IRS NAV

Rotate IRS Mode Selector to NAV and verify ALIGN light illuminated.

Set IRS position Enter

737 Flight Crew Operations Manual

Enter present position. If ALIGN light flashes, re-enter same present position over displayed position.

Note: Approximately five to seventeen minutes are required for alignment.

If ALIGN light continues to flash, maintenance action is required.

Fast Realignment

Prior to commencing procedure the airplane must be parked and not moved until procedure is complete and ALIGN lights extinguish.

IRS mode selectors ALIGN

Observe ALIGN lights illuminate steadily.

CDUSet

Enter present position on SET IRS POS line of the POS INIT page.

IRS mode selectorNAV

Observe ALIGN light extinguished within 30 seconds.

Note: If time permits it is preferable to perform a full alignment of the IRS. A more precise alignment will result.

Note: If the mode selector is accidentally switched to OFF or ATT, position mode selector to OFF, wait for ALIGN light(s) to extinguish, then perform full alignment procedure.

Inadvertent Selection of Attitude Mode (while on the ground)

Inadvertent selection of the attitude mode may be due to physically overpowering the switch during turn-on or may be the result of a faulty switch which prevents the flight crew from accurately determining which mode is selected.

If ATT position is selected inadvertently when switching to NAV

IRS mode selectors OFF

Observe ALIGN lights extinguish.

After ALIGN lights extinguish, initiate a full alignment.

IRS Entries**Present Position Entry**

IRS mode selectorNAV

ALIGN lights must be illuminated (steady or flashing).

IRS display selectorPPOS

LatitudeEnter

Key—in latitude in the data display, beginning with N or S, then press the ENT Key (the Cue Lights extinguish).

LongitudeEnter

Key—in longitude in the data display, beginning with E or W, then press the ENT key (the cue lights extinguish). Observe that proper latitude and longitude are displayed and that the ALIGN light is not flashing.

Heading – Enter through CDU

FMC/CDU POS INIT page Select

Enter the correct heading into the CDU scratch pad then press line select key 5R. Verify entered heading appears on line 5R. Select HDG on the IRS display selector and verify that the entered heading is displayed on the navigation displays.

| Heading – Enter through ISDU

IRS display selectorHDG

Press the H key to initiate a heading entry.

Key—in present magnetic heading. Press the ENT key (the cue lights extinguish). Observe proper heading displayed on the navigation displays.

Lateral Navigation (LNAV)

Proceeding Direct to a Waypoint (overwrite)

RTE LEGS page Select

On page 1/XX, line 1L, enter desired waypoint over the presently active waypoint.

Correct any ROUTE DISCONTINUITY if entered waypoint was not in original flight plan.

Intercepting a Leg (Course) to a Waypoint

RTE LEGS page Select

737 Flight Crew Operations Manual

On page 1/XX, line 1L, enter desired waypoint over presently active waypoint.

Observe INTC CRS prompt displayed in line 6R.

Enter the desired intercept course in the INTC CRS line. Observe the desired course is displayed on line 6R but, with magnetic variation differences in line 1.

Correct any ROUTE DISCONTINUITY if the entered waypoint was not in original flight plan.

EXEC key Push

Observe MOD RTE LEGS page changes to ACT.

LNAV may disengage after execution of an intercept leg to a waypoint. If LNAV disengages, turn to a heading to satisfy LNAV capture criteria, as described in Chapter 11, and then engage LNAV.

Route Modification

RTE LEGS or RTE page Select

Line select existing waypoints in the desired sequence.

Key—in any new waypoints in the scratch pad and line select into the flight plan. Correct any ROUTE DISCONTINUITIES.

EXEC key Push

Observe MOD RTE or MOD RTE LEGS page changes to ACT.

Route Removal

RTE page Select

ORIGIN Enter

If EXEC key illuminates

EXEC key Push

Linking a Route Discontinuity

Correct the ROUTE DISCONTINUITY by entering or deleting waypoints in a sequence that provides a continuous flight–plan path.

EXEC key Push

Observe MOD RTE or MOD RTE LEGS page changes to ACT.

Determining ETA and Distance to Cross Radial (Bearing) or Distance from a Fix

FIX INFO page Select

Enter the identifier of the reference waypoint (normally an off-route waypoint) onto the FIX line. Enter the desired radial or distance from the FIX on a RAD/DIS line, or line select the ABM prompt if the desired radial from the FIX is perpendicular to the present route/course.

Time and distance to go Check

Check ETA and DTG, as desired.

Note: If ETA and DTG are not displayed, the fix radial and/or distance do not intersect the route.

Changing Destination

RTE page Select

Enter the new destination over the original DEST. Enter desired routing to the new destination using the RTE, RTE LEGS, and ARRIVALS pages, as appropriate. Correct any ROUTE DISCONTINUITY.

EXEC key Push

Observe the MOD RTE or MOD RTE LEGS page changes to ACT.

Note: If destination is changed during climb, performance predictions may be blanked if the new flight plan is incompatible with the entered cruise altitude. Correct by entering a lower CRZ ALT on the CLB page.

Entering Holding Fix Into Route

HOLD key Push

(If RTE HOLD page is displayed, observe NEXT HOLD prompt. Line select 6L until (RTE LEGS) HOLD AT page is displayed.)

Observe HOLD AT box prompts and PPOS prompt (if in flight) are displayed. Enter the holding fix in line 6L, or line select PPOS.

737 Flight Crew Operations Manual

If the holding fix is a waypoint in the active route, or PPOS was selected, observe MOD RTE HOLD page displayed. If the holding fix is a waypoint not in the active route, observe message HOLD AT XXXXX displayed in the scratch pad. Enter the holding fix into the route by line selecting in the desired waypoint sequence. Observe the MOD RTE HOLD page displayed. If displayed holding details are incorrect or inadequate, enter correct information on appropriate line(s).

EXEC key Push
Observe MOD RTE HOLD page changes to RTE HOLD (ACT RTE HOLD if holding at PPOS).

Exiting Holding Pattern

HOLD key Push
Observe EXIT HOLD prompt displayed.

EXIT HOLD line select key Push
Observe EXIT HOLD prompt changes to EXIT ARMED.

EXEC key Push
Observe EXIT ARMED is highlighted in reverse video and LNAV flight returns to the holding fix and resumes the active route.

Note: The holding pattern may be exited by performing a DIRECT TO modification if desired. In this case, the flight path may not return to the holding fix before proceeding to the selected waypoint.

Note: A late sequencing of the hold exit waypoint may occur if multiple route modifications are performed just prior to exiting the hold. LNAV guidance may be temporarily interrupted while sequencing the hold exit waypoint.

Along Track Displacement

RTE LEGS page Select
Line select the reference waypoint to the scratch pad. Add a “/” and the + or – distance desired. (EX: SEA/15 for a point 15 miles downtrack from SEA)

Line select the reference waypoint. (The FMC will automatically position the created waypoint to appropriate position.)

EXEC key Push

Observe the MOD RTE LEGS page change to ACT.

Entering Created Waypoints on the Route or Route Legs Pages

Note: Created waypoints are stored in the temporary navigation data base for one flight only.

RTE or RTE LEGS page Select

Using any of the following methods, key into the scratch pad the parameters which define the new created waypoint (place identifiers must already be stored in one of the FMC data bases):

- Place bearing/distance (for example, SEA250/40);
- Place bearing/place bearing (for example, SEA180/ELN270);
- Along-track displacement (for example, SEA/-10);
- Latitude and longitude (for example, N4731.8W12218.3).

Enter into the route by line selecting to the appropriate waypoint sequence.

Repeat the above steps to define additional created waypoints as desired. Correct any ROUTE DISCONTINUITY.

EXEC key Push

Observe the MOD RTE or MOD RTE LEGS page changes to ACT (for an inactive route, activate and execute on the RTE or RTE LEGS page).

Entering Created Waypoints on the Nav Data Pages

Note: Created waypoints entered on the SUPP NAV DATA pages (permitted on the ground only) are stored in the supplemental navigation data base for an indefinite time period; those entered on REF NAV DATA pages are stored in the temporary navigation data base for one flight only.

INIT/REF key Push

Observe INDEX prompt displayed.

INIT/REF INDEX page Select

Observe the NAV DATA prompt displayed. To access the SUPP NAV DATA page, enter SUPP into the scratch pad.

NAV DATA page Select

737 Flight Crew Operations Manual

(If the SUPP NAV DATA page is selected, observe the EFF FRM date line displayed. If an effective date had not been previously entered, box prompts are displayed. The effective date must be entered before proceeding. If required, enter the current or appropriate date on EFF FRM line and execute.)

Data Enter

Enter a crew-assigned identifier on either the WPT IDENT, NAVAID IDENT, or AIRPORT IDENT line, as appropriate. Use the navaid category only for stations with DME.

For a WPT IDENT entry, define the waypoint with entries for either latitude and longitude, or with entries for REF IDENT and RADIAL/DIST (REF IDENT identifier must already be stored in one of the FMC data bases).

For a NAVAID IDENT or AIRPORT IDENT entry, enter appropriate data.

EXEC key illuminates when data has been entered into all box prompts.

EXEC key Push

Repeat above steps to define additional created waypoints as desired. To enter a new identifier in the same category, simply overwrite the previous identifier.

Note: To enter a created waypoint into the flight plan, key the identifier into the scratch pad and follow the route modification procedure.

Deleting Created Waypoints on the Nav Data Pages

INIT/REF key Push

Observe the INDEX prompt displayed.

INIT/REF INDEX page Select

Observe the NAV DATA prompt displayed. To access the SUPP NAV DATA page, key SUPP into the scratch pad.

NAV DATA page Select

Enter the identifier on either the WPT IDENT, NAVAID IDENT, or AIRPORT IDENT line, as appropriate.

Data Delete

Push the DEL key and then line select the identifier. Observe the EXEC key illuminates.

EXEC key Push

Data previously entered is deleted. Observe NAV DATA page displayed with prompts.

Entering a Crossing Radial (Bearing) or Distance from a Fix as a Route Waypoint

FIX INFO page Select

Enter identifier of the reference waypoint (normally an off-route waypoint) onto the FIX line. Enter the desired radial or distance from the FIX on a RAD/DIS line, or line select the ABM prompt if the desired radial or distance from the FIX is perpendicular to the present route/course.

Line select the desired intersection (lines 2L–5L) into the scratch pad and observe the new created waypoint displayed as FIX/Radial/Distance.

RTE LEGS page Select

Line select the new created waypoint, displayed in the scratch pad, to the desired waypoint sequence.

Repeat the above steps to define additional created waypoints as desired. Correct any ROUTE DISCONTINUITIES.

EXEC key Push

Observe the MOD RTE LEGS page changes to ACT.

Note: These created waypoints are stored in the temporary navigation data base for one flight only.

Entering a Lateral Offset

RTE page Select

Observe the OFFSET prompt displayed.

LATERAL OFFSET page Select

Observe dash prompts for OFFSET DIST.

OFFSET DIST Enter

Enter desired offset distance using format Lxx or Rxx for left or right offset up to 99 nm. Observe dash prompts for START WAYPOINT and END WAYPOINT.

START/END WAYPOINT Enter

If no start/end waypoint is entered, offset will begin/end at first/last valid offset leg.

Change SID or Runway

This entire procedure must be accomplished when a SID is used and the runway or SID is changed. This will prevent the possibility of incorrect routing or inadequate obstacle clearance.

DEPARTURES page Select

RUNWAY Reselect

SID Reselect

TRANSITION (if required) Reselect

RTE LEGS page Select

WAYPOINT SEQUENCE and ALTITUDES Check

Modify as necessary to agree with clearance.

EXEC key Push

Change STAR, PROF DES, or APP

The associated airport must be entered as route origin or destination.

ARRIVAL page Select

STAR or PROFILE DESCENT (if required) Select

TRANSITION (if required) Select

APPROACH Select

APPROACH TRANSITION (if required) Select

RTE LEGS page Select

WAYPOINT SEQUENCE CHECK

Modify as necessary to agree with clearance.

EXEC key Push

Delete Procedure Turn

DEP/ARR page Select

Approach Select

Reselecting same approach or selecting a new approach will remove procedure turn and select a straight in approach on the LEGS page.

EXEC key Push

or

RTE LEGS page Select

Select last waypoint of procedure turn to scratchpad and overwrite PROC TURN line. Check waypoint sequencing to comply with clearance.

EXEC key Push

Other Operations

FMC Navigation Check

If the IRS NAV ONLY, VERIFY POSITION, or UNABLE REQUIRED NAV PERFORMANCE – RNP message is displayed in the scratch pad, or course deviation is suspected, accomplish the following as necessary to ensure navigation accuracy:

Actual position Determine and compare with FMC position

Determine actual airplane position using raw data from VHF navigation or ADF radios.

If radio nav aids are unavailable:

FMC position Compare with the IRS position

Use the POS SHIFT page of the FMC CDU. If the two IRS positions are in agreement and the FMC position is significantly different, the FMC position is probably unreliable. The POS SHIFT page may be used to shift FMC position to one of the IRS positions. This is accomplished by line selecting the IRS or radio position and then pressing the EXEC Key.

Actual position Confirm with ATC radar or visual reference points.

737 Flight Crew Operations Manual

Navigate using most accurate information available (continue to monitor FMC position using VOR/ADF raw data displays on non-flying pilot's navigation display).

CAUTION: Navigating in LNAV mode with an unreliable FMC position may result in significant navigation errors.

Navigate by conventional VOR/ADF procedures, radar vectors from ATC, dead reckoning from last known position, and/or use of visual references.

Inhibiting VOR/DME Use for Position Updating

Note: This procedure inhibits the use of VOR/DME information for FMC position updating. Use DEL key to remove a VOR/DME from inhibit status.

PROG page Select
Observe NAV STATUS prompt displayed.

NAV STATUS page Select

NAV OPTIONS page Select (NEXT/PREV page)
Observe dash prompts for VOR/DME INHIBIT. Enter desired VOR/DME identifier (a previous entry may be overwritten but will no longer be inhibited).

Inhibiting GPS Updating

Note: GPS position updates are allowed for all United States National Airspace approach operations. Outside this region, GPS position updates are allowed during approaches only if the FMC database and approach charts are referenced to the WGS-84 reference datum. GPS updates should be inhibited for all other approach operations.

PROG page Select
Observe NAV STATUS prompt displayed.

NAV STATUS page Select

NAV OPTIONS page Select (NEXT/PREV page)

GPS UPDATE OFF

Vertical Navigation (VNAV)

Temporary Level Off during Climb or Descent (Not at FMC Cruise Altitude)

MCP altitude selectorSet desired altitude

MCP N1 light will extinguish if leveling from a climb.

N1 Limit changes to CRZ if leveling from a climb.

To continue climb/descent:

MCP altitude selectorSet desired altitude

Entering Waypoint Speed and Altitude Restriction (On Climb or Descent Legs Only)

RTE LEGS page Select

Key-in desired speed and altitude, or speed only (followed by /), or altitude only, into scratch pad.

An altitude followed by A or B signifies a requirement to be “at or above” or “at or below” that altitude at the waypoint (for example, key-in 220A or 240B).

Line select to desired waypoint line.

EXEC key Push

Observe MOD RTE LEGS page changes to ACT.

Note: This changes any prior speed and altitude restriction at this waypoint.

Deleting Waypoint Speed and Altitude Restriction

RTE LEGS page Select

Push DEL key to enter DELETE in scratch pad. Line select to appropriate waypoint line.

EXEC key Push

Observe MOD RTE LEGS page changes to ACT and restriction is deleted and replaced with an FMC predicted value (small size characters).

Changing Speed and/or Altitude Restriction during Climb or Descent

CLB/DES page Select

Push DEL key to enter DELETE in the scratch pad, or key-in the desired speed and altitude in the scratch pad. Line select to the SPD REST line.

EXEC key Push

Observe the MOD CLB or the MOD DES page changes to ACT and the restriction is changed or deleted.

Changing Climb/Cruise/Descent Speed Schedule

CLB/CRZ/DES page Select

Select the prompt for the desired climb/cruise/descent schedule, or key-in the desired speed in the scratch pad and line select to the TGT SPD line.

EXEC key Push

Observe the MOD CLB, MOD CRZ, or MOD DES page changes to ACT and new speed schedule is specified.

Early Descent

MCP altitude selector Set

Set next level-off altitude.

DES page Select

Line select DES NOW prompt.

EXEC key Push

Observe MOD DES page changes to ACT. Observe descent is initiated (if VNAV engaged).

Note: For a PATH DES, this will result in a 1000 FPM rate of descent until the planned path is intercepted. For a SPD DES, this will result in an idle thrust normal rate of descent.

Step Climb or Descent from Cruise

MCP altitude selector Set

Set new level-off altitude.

CRZ page Select

Enter new altitude on the CRZ ALT line. The display changes to MOD CRZ CLB or MOD CRZ DES.

If the desired climb/descent speed is different from the displayed cruise speed, manually enter the desired TGT SPD, or use access prompts to select desired CLB/DES page.

EXEC key Push

Observe the MOD CRZ CLB/MOD CRZ DES page (or other selected MOD CLB/MOD DES page) changes to ACT. Observe climb/descent is initiated at the TGT SPD (if VNAV engaged).

Performance and Progress Functions

Determining ETA and Fuel Remaining for New Destination

RTE page Select

Enter the new destination over the original DEST. Enter correct routing to the new destination using RTE, RTE LEGS, and ARRIVALS pages, as appropriate. Correct any ROUTE DISCONTINUITY.

PROGRESS page Select

Observe new destination with a MOD title. Check ETA and FUEL remaining.

RTE page Select

EXEC or ERASE the new destination/routing, as desired. Observe MOD RTE page changes to ACT.

Estimated Wind Entries for Cruise Waypoints

RTE LEGS page Select

Observe the DATA prompt displayed.

RTE DATA page Select

Enter the estimated true wind direction/speed on the appropriate line(s).

Step Climb Evaluation

CRZ page Select

Enter the desired step climb altitude on the STEP line. If known, enter the estimated average true wind direction/speed for the desired step climb altitude on the ACTUAL WIND line.

Step climb savings Determine

Observe the fuel SAVINGS/PENALTY and FUEL AT _____ (destination) lines to determine if a higher cruise altitude is advantageous.

If step climb fuel savings are significant, use the appropriate climb procedure to initiate climb to the higher altitude when NOW is displayed on STEP POINT line.

Note: Step climb evaluations do not consider buffet margin limits. If the altitude entered for the step climb evaluation is higher than the maximum altitude for flight with an adequate buffet margin, the message “MAX ALT FLXXX” will be displayed in the scratch pad. Ensure the new cruise altitude entered for the climb is at or below the MAX ALT displayed in the message in order to maintain a safe buffet margin.

Entering Descent Forecasts

DES page Select

Observe FORECAST prompt displayed.

DES FORECASTS page Select

Verify the TRANS LVL and revise if required. Enter average ISA DEV forecast for descent and destination QNH. Enter forecast descent WINDs (for up to three different altitudes).

EXEC key Push

Observe MOD DES FORECASTS page changes to ACT.

Engine Out

Engine out climb and cruise pages provide advisory information for engine out operation. Refer to section 11.41 and 11.42 for a complete description of ENG OUT CLB and ENG OUT CRZ pages.

Required Time of Arrival (RTA)

Note: An active FMC flight plan complete with all performance data must exist before the required time of arrival (RTA) mode can be used.

Entering an RTA Waypoint and Time

RTA PROGRESS page Select

On PROGRESS page 2, line 1L, enter the flight plan waypoint where required time of arrival is applicable. Observe the MOD RTA PROGRESS page displayed with the computed ETA, for the entered waypoint, displayed in line 1R.

RTA Enter

Enter required time of arrival into line 1R. Time should be entered in hours, minutes, and seconds (Examples: 174530, 1745, 1745.5). Observe MOD RTA PROGRESS page displayed with pertinent data for complying with entered RTA. Observe EXEC key illuminated.

EXEC key Push

Observe ACT RTA PROGRESS page displayed.

Entering Speed Restrictions for RTA Navigation

PERF LIMITS page Select

Enter minimum or maximum speed restriction for RTA navigation in lines 2, 3, or 4 depending on phase of flight. Observe RTA parameters change to reflect new limits (RTA PROGRESS page) and EXEC key illuminated.

EXEC key Push

Observe MOD PERF LIMITS page change to ACT PERF LIMITS page.

Note: Entered restrictions on line 2, 3, and 4 also restrict other navigation modes such as ECON.

Entering New Time Error Tolerances for RTA Navigation

PERF LIMITS page Select

737 Flight Crew Operations Manual

Enter desired time error tolerance (5 to 30 seconds) for the RTA waypoint on line 1L (Example: 25). Observe MOD PERF LIMITS page displayed and EXEC key illuminated.

EXEC key Push
Observe ACT PERF LIMITS page displayed.

Additional CDU Functions**Navigation Display Plan Mode (Center Step Operation)**

EFIS Control Panel Mode Selector PLAN
RTE LEGS page Select
EFIS Control Panel Range Selector As required
MAP CTR STEP key Push
Each push moves the CTR label to the next geographically fixed waypoint in the route. Selecting PREV PAGE or NEXT PAGE moves the CTR label to the first geographically fixed waypoint on the new page.

EFIS Control Panel Mode Selector As required

Enter Position Shift on Runway

TAKEOFF REF page Select
YA373 - YA377, YC202 - YC207, YE324 - YE326
TO SHIFT distance Enter
Enter distance desired from runway threshold. When TO/GA is pushed, FMC will update position to runway threshold plus entered distance.

YA371, YA372, YC201, YE321 - YE323
RWY REMAIN distance Enter
Enter runway remaining distance. When TO/GA is pushed, FMC will update to the runway remaining distance.

If position shift must be removed

RTE page Select



RWYEnter

Reenter runway on RTE page. Check and reenter other performance data as required.



Fuel Balancing

If a fuel leak is suspected:

Accomplish the ENGINE FUEL LEAK checklist.

Maintain main tank No. 1 and No. 2 fuel balance within limitations.

Note: Fuel pump pressure should be supplied to the engines at all times. At high altitude, without fuel pump pressure, thrust deterioration or engine flameout may occur.

If the center tank contains fuel:

Center tank fuel pump switches OFF
[Fuel CONFIG indication may be displayed with fuel in the center tank.]

Crossfeed selector Open

Fuel pump switches (low tank) OFF

When quantities are balanced:

Fuel pump switches (main tank) ON

Center tank fuel pump switches ON

Crossfeed selector Close

If the center tank contains no fuel:

Crossfeed selector Open

Fuel pump switches (low tank) OFF

When quantities are balanced:

Fuel pump switches ON

Crossfeed selector Close

Refueling

Fuel Load Distribution

Main tanks No. 1 and No. 2 should normally be serviced equally until full. Additional fuel is loaded into the center tank until the desired fuel load is reached.

Note: Main tanks No. 1 and No. 2 must be scheduled to be full if the center tank contains more than 453 kgs of fuel. With less than 453 kgs of center tank fuel, partial main tank fuel may be loaded provided the effects of balance have been considered.

Fuel Pressure

Apply from a truck or fuel pit. A nozzle pressure of 50 psi provides approximately 1136 liters per minute.

Normal Refueling

When a full fuel load is required, the fuel shutoff system closes the fueling valves automatically when the tanks are full. When a partial fuel load is required, the fuel quantity indicators are monitored and the fueling valves are closed by manually positioning the fueling valve switches to CLOSED when the desired fuel quantity is aboard the airplane.

Refueling with Battery Only

When the APU is inoperative and external power is not available, refueling can be accomplished as follows:

Battery switch ON

Note: The refueling system will operate normally. Operation is limited only by battery life.

Refueling with No AC or DC Power Source Available

When it becomes necessary to refuel with the APU inoperative, the aircraft battery depleted, and no external power source available, refueling can still be accomplished:

Fueling hose nozzle Attached to the refueling receptacle

737 Flight Crew Operations Manual

Fueling valves Open for the tanks to be refueled

Note: Main tanks No. 1 and No. 2, and the center tank refueling valves each have a red override button that must be pressed and held while fuel is being pumped into the tank. Releasing the override button allows the spring in the valve to close the valve.

Caution must be observed not to overfill a tank, since there is no automatic fuel shutoff during manual operation. When the desired amount of fuel has been pumped into the tanks, the refueling valves for the respective tanks can be released.

Ground Transfer of Fuel

Fuel can be transferred from one tank to another tank by using the appropriate fuel pumps, the fueling valve, the defueling valve, and the crossfeed valve. AC power must be available. To transfer fuel from the main tanks to the center tank:

Main tank fuel pump switches ON

Crossfeed selector Open

Manual defueling valve Open

Center tank fueling valve switch OPEN

Fuel transfer Monitor

The center tank fuel quantity indicator shows an increase in fuel.

The main tank indicators show a decrease in fuel.

Center tank fueling valve switch CLOSED

When the required amount of fuel has been transferred, the switch is closed at the fueling panel.

Manual defueling valve Close

Crossfeed selector Close

Main tank fuel pump switches OFF

Main Tanks Refill

Refueling panel and defuel panel access doors Close



Fuel Crossfeed Valve Check

Crossfeed selectorOpen

Verify crossfeed VALVE OPEN light illuminates bright and then dim.

Crossfeed selectorClose

Verify crossfeed VALVE OPEN light illuminates bright and then extinguishes.



Introduction

Airplane operation in adverse weather conditions may require additional considerations due to the effects of extreme temperatures, precipitation, turbulence, and windshear. Procedures in this section supplement normal procedures and should be observed when applicable.

The following recommendations apply to adverse weather operations in general:

- Do not use assumed temperature reduced thrust for takeoff on a contaminated runway.
- V1 may be reduced down to minimum V1 (assuming all weight limitations are considered) to provide increased stopping distance performance.
- Takeoffs on slippery runways are not recommended when slush or wet snow is more than 1/2 inch (13mm) in depth.
- Improved stall margins can be achieved by the following:
 - If excess runway is available, consider using improved climb procedures for flaps 5.
 - If runway is limited for the planned takeoff flap setting, consider using the next greater flap position with improved climb performance. This will provide additional stall margins with minimum performance penalties.

Cold Weather Operation

Considerations associated with cold weather operation are primarily concerned with low temperatures and with ice and snow on the airplane, ramps, taxiways and runways.

Icing conditions exist when OAT (on the ground) or TAT (in-flight) is 10°C (50°F) or below and:

- visible moisture (clouds, fog with visibility less than one mile, rain, snow, sleet, ice crystals, and so on) is present, or
- standing water, ice, or snow is present on the ramps, taxiways, or runways.

Note: Do not operate engine or wing anti-ice when in-flight total air temperature (TAT) is above 10°C (50°F.)

Exterior Inspection - Captain or First Officer

Although removal of surface snow, ice or frost is normally a maintenance function, the flight crew should use additional care and scrutiny during preflight preparation to inspect areas where surface snow or frost could change or affect normal system operations.

Do the normal Exterior Inspection with the following additional steps:

Surfaces Check

Check for frost, snow or ice.

Thin hoarfrost is acceptable on the upper surface of the fuselage provided all vents and ports are clear. Thin hoarfrost is a uniform white deposit of fine crystalline texture, which usually occurs on exposed surfaces on a cold and cloudless night, and which is thin enough to distinguish surface features underneath, such as paint lines, markings or lettering.

Control balance cavities Check

Check drainage after snow removal. Puddled water may refreeze in flight.

Landing gear doors Check

Landing gear doors should be free of snow or ice.

Air conditioning inlets and exits Clear

Verify that the air inlets and exits, including the outflow valve, are clear of snow or ice.

If the APU is operating, verify that the outflow valve is fully open.

Engine inlets Clear

Verify that the inlet cowling is free of ice or snow.

Verify that the fan is free to rotate.

APU air inlets Check

The APU inlet door and cooling air inlet must be free of snow or ice prior to APU start.

Fuel tank vents Clear

Check all fuel tank vents. All traces of ice or frost should be removed.

737 Flight Crew Operations Manual

Pitot probes and static ports Clear

Verify that all pitot probes and static ports free of ice and snow. Water rundown after snow removal may refreeze immediately forward of static ports and cause an ice buildup which disturbs airflow over the static ports resulting in erroneous static readings even when static ports themselves are clear.

Preflight Procedure - First Officer

Do the following step after completing the normal Preflight Procedure - First Officer:

PROBE HEAT ON

All probe heat lights – extinguished.

Engine Start Procedure

Do a normal engine start with the following modifications:

- If the engine has been cold soaked for one or more hours at ambient temperatures less than -40°C , do not start or motor the engine. Maintenance personnel should accomplish appropriate procedures for adverse weather heating of the Hydro-Mechanical Unit.
- If the engine has been cold soaked for three or more hours at ambient temperatures less than -40°C , do not start or motor the engine. Maintenance personnel should accomplish appropriate procedures for adverse weather starter servicing.
- If ambient temperature is below -35°C (-31°F), idle the engine for two minutes before changing thrust lever position.
- Up to three and one-half minutes may be allowed for oil pressure to reach the minimum operating pressure. During this period, the LOW OIL PRESSURE light may remain illuminated, pressure may go above the normal range and the FILTER BYPASS light may illuminate. Operate the engine at idle thrust until oil pressure returns to the normal range.

Before Taxi Procedure

Do the normal Before Taxi Procedure with the following modifications:

GENERATOR 1 and 2 switches ON F/O

Normally the engine IDG's will stabilize within one minute, although due to cold oil, up to five minutes may be needed to produce steady power.

Flight controls Check C

An increase in control forces can be expected at low temperatures because of increased resistance in cables and thickened oil in snubbers and bearings.

If any flight control is suspected of binding or restricted movement, maintenance personnel should do the appropriate portion of SP.9, Flight Controls Check Supplementary Procedure.

CAUTION: The flap position indicator and leading edge devices annunciator panel should be closely observed for positive movement. If the flaps should stop, the flap lever should be placed immediately in the same position as indicated.

ENGINE ANTI-ICE switches As needed F/O

Engine anti-ice must be ON during all ground operations when icing conditions exist or are anticipated.

WARNING: Do not rely on airframe visual icing cues before activating engine anti-ice. Use the temperature and visible moisture criteria.

When engine anti-ice is needed:

ENGINE START switches CONT F/O

ENGINE ANTI-ICE switches ON F/O

Verify that the COWL VALVE OPEN lights illuminate bright, then dim.

Verify that the COWL ANTI-ICE lights are extinguished.

Note: If the COWL VALVE OPEN lights remain illuminated bright with engines at IDLE, position APU BLEED air switch to OFF and increase thrust slightly (up to a maximum of 30% N1.)

737 Flight Crew Operations Manual

WING ANTI-ICE switchAs needed F/O

Use wing anti-ice during all ground operations between engine start and takeoff when icing conditions exist or are anticipated, unless the airplane is protected by the application of Type II or Type IV fluid in compliance with an approved ground de-icing program.

WARNING: Do not use wing anti-ice as an alternative for ground de-icing/anti-icing. Close inspection is still needed to ensure that no frost, snow or ice is adhering to the wing, leading edge devices, stabilizer, control surfaces or other critical airplane components at takeoff.

When wing anti-ice is needed:

WING ANTI-ICE switchON F/O

Verify that the R and L VALVE OPEN lights illuminate bright, then dim.

Note: The wing anti-ice VALVE OPEN lights may cycle bright/dim due to the control valves cycling closed/open in response to thrust setting and duct temperature logic.

Flaps Check F/O

Move flaps from Flaps up to Flaps 40 back to Flaps up (i.e., full travel) to ensure freedom of movement.

CAUTION: The flap position indicator and leading edge devices annunciator panel should be closely observed for positive movement. If the flaps should stop, the flap lever should be placed immediately in the same position as indicated.

Call “FLAPS ___” as needed. C

FlapsAs needed F/O

If taxi route is through slush or standing water in low temperatures or if precipitation is falling with temperatures below freezing, taxi with flaps up. Taxiing with flaps extended subjects the flaps and flap drives to snow and slush accumulations from the main gear wheels. Leading edge devices are also susceptible to slush accumulations.

Taxi-Out

Do the following steps during the taxi-out:

Nose wheel steering Check C

Nose wheel steering should be exercised in both directions during taxi to circulate warm hydraulic fluid through steering cylinders and minimize steering lag caused by low temperatures.

Engine run up Do as needed C

Run-up to as high a thrust setting as practical (70% N1 recommended) at 30 minute intervals for approximately 30 seconds duration.

If airport surface conditions and the concentration of aircraft do not permit the engine thrust level to be increased to 70%, then set a thrust level and time at that thrust level as high as practical.

Note: When operating in conditions of freezing rain, freezing drizzle, freezing fog or heavy snow, additional momentary run-ups to 70% N1 at intervals of 10 minutes or less should be considered.

Exterior De-icing

Flaps UP F/O

Flaps should be positioned up to prevent ice and slush from accumulating in flap cavities during de-icing.

Thrust levers Idle C

Stabilizer trim Full APL NOSE DOWN C

Trim the airplane to the electrical APL NOSE DOWN limit. Then continue trimming manually to the manual APL NOSE DOWN limit. The full nose down position prevents de-icing fluid and slush run-off from entering the stabilizer balance panel cavity.

WARNING: To avoid personal injury, ensure that the stabilizer trim wheel handle is stowed prior to using electric trim.

APU and engine BLEED air switches OFF F/O

The bleed air switches must be turned off to reduce the possibility of fumes entering the air conditioning system.

CAUTION: With the APU operating, ingestion of deicing fluid causes objectionable fumes and odors to enter the airplane. This may also cause erratic operation or damage to the APU.

APU As needed F/O

737 Flight Crew Operations Manual

Wait approximately one minute after completion of deicing to turn engine BLEED air switches on to ensure all deicing fluid has been cleared from the engine:

Engine BLEED air switches	ON	F/O
Stabilizer trim	___ UNITS	C

Verify stabilizer trim is set for takeoff.

Before Takeoff Procedure

Do the following steps after completing the normal Before Takeoff Procedure:

Call "FLAPS ___" as needed for takeoff.	C
---	---

Flap lever	Set takeoff flaps, as needed	F/O
------------------	------------------------------	-----

Extend the flaps to the takeoff setting at this time if they have been held because of slush, or standing water or icing conditions or because of exterior de-icing.

Verify that the LE FLAPS EXT green light is illuminated.

Stabilizer trim	___ UNITS	C
-----------------------	-----------	---

Verify that the stabilizer trim is set for takeoff.

If airplane deicing was accomplished:

A visual inspection of the airplane wings should be made by the pilots just prior to takeoff.

Takeoff Procedure

Do the normal Takeoff Procedure with the following modification:

Engine run-up	Accomplish as needed	PF
---------------------	----------------------	----

If moderate to severe icing conditions are present, the takeoff roll must be preceded by a static run-up to 70% N1 and stable engine operation observed prior to brake release. If the airplane starts to slide on ice or snow during engine power check, release brakes and begin takeoff roll. Continue engine check during early part of the takeoff roll.

Climb and Cruise Procedure

Do the normal Climb and Cruise Procedure with the following additional steps:

ENGINE ANTI-ICE switches As needed PM

Engine anti-ice must be ON during all flight operations when icing conditions exist or are anticipated, except during climb and cruise when the temperature is below -40°C SAT . Engine anti-ice must be ON prior to, and during descent in all icing conditions, including temperatures below -40°C SAT .

When operating in areas of possible icing, activate engine anti-ice prior to entering icing conditions. Late selection of engine anti-ice may allow inlet ice buildup and ice shedding into the engine.

WARNING: Do not rely on airframe visual icing cues before activating engine anti-ice. Use the temperature and visible moisture criteria.

When engine anti-ice is needed:

ENGINE START switches CONT PM

ENG ANTI-ICE switches ON PM

Verify that the COWL VALVE OPEN lights illuminate bright, then dim.

Verify that the COWL ANTI-ICE lights are extinguished.

Note: If the COWL VALVE OPEN lights remain illuminated bright with engines at IDLE, position the APU BLEED air switch to OFF and increase thrust slightly (up to a maximum of 30% N1.)

CAUTION: Avoid prolonged operation in moderate to severe icing conditions.

Severe icing can usually be avoided by a change in altitude and/or airspeed. If flight in moderate to severe icing conditions cannot be avoided, do the following on both engines, one engine at a time at approximately 15 minute intervals:

Note: At higher altitudes, a descent can be needed:

Thrust Increase PF

Increase thrust to a minimum of 80% N1 to ensure the fan blades and spinner are clear of ice.

737 Flight Crew Operations Manual

Engine vibration may occur due to fan blade/spinner icing. If engine vibration continues after increasing thrust, do the following on both engines, one engine at a time:

ENGINE START switch FLT PM |

Thrust Adjust PF |

Adjust thrust to 45% N1. After approximately five seconds, increase thrust lever slowly to a minimum of 80% N1.

Note: Engine vibration may reduce to a low level before 80% N1 is reached, however, thrust increase must continue to a minimum of 80% N1 to remove ice from the fan blades.

Note: Engine vibration may indicate full scale prior to shedding ice, however, this has no adverse effect on the engine.

If vibration does not decrease, do the procedure for HIGH ENGINE VIBRATION “If not in icing conditions.”

When engine anti-ice is no longer needed:

ENGINE ANTI-ICE switches OFF PM |

Verify that the COWL VALVE OPEN lights are extinguished

ENGINE START switches OFF PM |

WING ANTI-ICE switch As needed PM

The wing anti-ice system may be used as a de-icer or anti-icer in flight only. The primary method is to use it as a de-icer by allowing ice to accumulate before turning wing anti-ice on. This procedure provides the cleanest airfoil surface, the least possible runback ice formation, and the least thrust and fuel penalty.

The secondary method is to use wing anti-ice prior to ice accumulation. Operate the wing anti-ice system as an anti-icer only during extended operations in moderate or severe icing conditions, such as holding.

Ice accumulation on the flight deck window frames, windshield center post or on the windshield wiper arm may be used as an indication of structural icing conditions and the need to turn on wing anti-ice.

Normally it is not necessary to shed ice periodically unless extended flight through icing conditions is necessary (holding.)

CAUTION: Use of wing anti-ice above approximately FL350 may cause bleed trip off and possible loss of cabin pressure.

When wing anti-ice is needed:

WING ANTI-ICE switch ON PM

Verify that the R and L VALVE OPEN lights illuminate bright, then dim.

When wing anti-ice is no longer needed:

WING ANTI-ICE switch OFF PM

Note: Prolonged operation in icing conditions with the leading edge and trailing edge flaps extended is not recommended. Holding in icing conditions with flaps extended is prohibited.

Approach and Landing

Use normal procedures and reference speeds unless a flaps 15 landing is planned.

If a flaps 15 landing will be made:

Set VREF 15

737 Flight Crew Operations Manual

If any of the following conditions apply, set VREF ICE = VREF 15 + 10:

- engine anti-ice will be used during landing
- wing anti-ice has been used any time during the flight
- icing conditions were encountered during the flight and the landing temperature is below 10° C.

Taxi-In

Do the following steps:

If prolonged operation in icing conditions with the leading and trailing edge flaps extended was needed:

Flaps 15 F/O
Retraction to less than flaps 15 is not recommended until ice has been removed or a ground inspection has been made.

Engine anti-ice As needed F/O
If icing conditions exist, engine anti-ice must be ON.

If taxi-in is delayed and icing conditions exist, do the following:

Engine run-up As needed C
Run-up to as high a thrust setting as practical (70% N1 recommended) at 30 minute intervals for approximately 30 seconds duration.

If airport surface conditions and the concentration of aircraft do not permit the engine thrust level to be increased to 70%, then set a thrust level and time at that thrust level as high as practical.

Note: When operating in conditions of freezing rain, freezing drizzle, freezing fog or heavy snow, additional momentary run-ups to 70% N1 at intervals of 10 minutes or less should be considered.

Shutdown Procedure

Do the following step before starting the normal Shutdown Procedure:

After landing in icing conditions:

Stabilizer trim Set 0 to 2 units C

Prevents melting snow and ice from running into balance bay areas and prevents the stabilizer limit switch from freezing. With flaps retracted, this requires approximately eight hand wheel turns of manual trim.

WARNING: To avoid personal injury, ensure that the stabilizer trim wheel handle is stowed prior to using electric trim.

Secure Procedure (Airplane Attended)

Do the following steps after completing the normal Secure Procedure:

If warm air circulation through cargo and E/E compartments is desired:

APU Start F/O

APU generator bus switches ON F/O

Verify that the BUS OFF lights are extinguished.

PACK switches AUTO F/O

ISOLATION VALVE switch OPEN F/O

Pressurization mode selector MAN F/O

Outflow valve switch OPEN F/O

Prevents aircraft pressurization.

Note: The airplane must be parked into the wind when the outflow valve is full open.

APU BLEED air switch ON F/O

Secure Procedure (Airplane Unattended)

Do the following steps after completing the normal Secure Procedure:

If staying overnight at off-line stations or airports where normal support is not available, the flight crew must arrange for or verify that the following steps are done:

Pressurization mode selector MAN

Outflow valve CLOSE

737 Flight Crew Operations Manual

Wheel chocks	Check in place
Parking brake	Release
Protective covers and plugs	Install
Water storage containers	Drain
Toilets	Drain
Battery	Remove
If the battery will be exposed to temperatures below -18° C (0° F), the battery should be removed and stored in an area warmer than -18° C (0° F), but below 40° C (104° F). Subsequent installation of the warm battery ensures the starting capability of the APU.	
Doors and sliding windows	Close

Hot Weather Operation

During ground operation the following considerations will help keep the airplane as cool as possible:

- While the airplane is electrically powered, packs should be run or cooling air supplied to the airplane when the OAT exceeds 40° C (103° F) to protect the reliability of electrical and electronic equipment in the airplane.
- If cooling air is available from an outside source, the supply should be plugged in immediately after engine shutdown and should not be removed until just prior to engine start.
- Keep all doors and windows, including cargo doors, closed as much as possible.
- Electronic components which contribute to a high temperature level in the flight deck should be turned off while not needed.
- Open all passenger cabin gasper outlets and close all window shades on the sun-exposed side of the passenger cabin.

YA371 - YA377, YE321 - YE326

If these actions do not reduce cabin temperatures sufficiently:

PASSENGER CABIN temperature selector	AUTO COOL
PACK switches	HIGH

If the cabin temperature remains high:

PASSENGER CABIN temperature
selector..... MAN COOL

Brake temperature levels may be reached which can cause the wheel fuse plugs to melt and deflate the tires. Consider the following actions:

- Be aware of brake temperature buildup when operating a series of short flight sectors. The energy absorbed by the brakes from each landing is accumulative.
- Extending the landing gear early during the approach provides additional cooling for tires and brakes.
- In-flight cooling time can be determined from the “Brake Cooling Schedule” in the Performance-Inflight section.

During flight planning consider the following:

- High temperatures inflict performance penalties which must be taken into account on the ground before takeoff.
- Alternate takeoff procedures (No Engine Bleed Takeoff, Improved Climb Performance, etc.)

Moderate to Heavy Rain

Flights should be conducted to avoid thunderstorm or hail activity by overflight or circumnavigation. To the maximum extent possible, moderate to heavy rain should also be avoided.

If heavy rain is encountered:

ENGINE START switches..... CONT

Thrust Levers Adjust Slowly

If thrust changes are necessary, move the thrust levers slowly.

Avoid changing thrust lever direction until engines have stabilized at a selected setting.

Turbulence

During flight in light to moderate turbulence, the autopilot and/or autothrottle may remain engaged unless performance is objectionable. Increased thrust lever activity can be expected when encountering wind, temperature changes and large pressure changes. Short-time airspeed excursions of 10 to 15 knots can be expected.

737 Flight Crew Operations Manual

Passenger signs ON

Advise passengers to fasten seat belts prior to entering areas of reported or anticipated turbulence. Instruct flight attendants to check that all passengers' seat belts are fastened.

Severe Turbulence

Autothrottle DISENGAGE

AUTOPILOT CWS

A/P status annunciators display CWS for pitch and roll.

Note: If sustained trimming occurs, disengage the autopilot.

ENGINE START switches FLT

Thrust Set

Set thrust as needed for the phase of flight. Change thrust setting only if needed to modify an unacceptable speed trend.

PHASE OF FLIGHT	AIRSPEED
CLIMB	280 knots or .76 Mach
CRUISE	Use FMC recommended thrust settings. If the FMC is inoperative, refer to the Unreliable Airspeed page in the Performance–Inflight section for approximate N1 settings that maintain near optimum penetration airspeed.
DESCENT	.76 Mach/280/250 knots. If severe turbulence is encountered at altitudes below 15,000 feet and the airplane gross weight is less than the maximum landing weight, the airplane may be slowed to 250 knots in the clean configuration.

Note: If an approach must be made into an area of severe turbulence, delay flap extension as long as possible. The airplane can withstand higher gust loads in the clean configuration.

Windshear

Windshear is a change of wind speed and/or direction over a short distance along the flight path. Indications of windshear are listed in the Windshear Escape Non-Normal maneuver in this manual.

Avoidance

The flight crew should search for any clues to the presence of windshear along the intended flight path. Presence of windshear may be indicated by:

- Thunderstorm activity
- Virga (rain that evaporates before reaching the ground)
- Pilot reports
- Low level windshear alerting system (LLWAS) warnings.

Stay clear of thunderstorm cells and heavy precipitation and areas of known windshear. If the presence of windshear is confirmed, delay takeoff or do not continue an approach.

Precautions

If windshear is suspected, be especially alert to any of the danger signals and be prepared for the possibility of an inadvertent encounter. The following precautionary actions are recommended if windshear is suspected:

Takeoff

- Use maximum takeoff thrust instead of reduced thrust
- For optimum takeoff performance, use flaps 5, 10 or 15 unless limited by obstacle clearance and/or climb gradient
- Use the longest suitable runway provided it is clear of areas of known windshear
- Consider increasing V_r speed to the performance limited gross weight rotation speed, not to exceed actual gross weight $V_r + 20$ knots. Set V speeds for the actual gross weight. Rotate at the adjusted (higher) rotation speed. This increased rotation speed results in an increased stall margin and meets takeoff performance requirements. If windshear is encountered at or beyond the actual gross weight V_r , do not attempt to accelerate to the increased V_r but rotate without hesitation.
- Be alert for any airspeed fluctuations during takeoff and initial climb. Such fluctuations may be the first indication of windshear

737 Flight Crew Operations Manual

- Know the all-engine initial climb pitch attitude. Rotate at the normal rate to this attitude for all non-engine failure takeoffs. Minimize reductions from the initial climb pitch attitude until terrain and obstruction clearance is assured, unless stick shaker activates.
- Crew coordination and awareness are very important. Develop an awareness of normal values of airspeed, attitude, vertical speed, and airspeed build-up. Closely monitor vertical flight path instruments such as vertical speed and altimeters. The pilot not flying should be especially aware of vertical flight path instruments and call out any deviations from normal.
- Should airspeed fall below the trim airspeed, unusual control column forces may be needed to maintain the desired pitch attitude. Stick shaker must be respected at all times.
- If windshear should be encountered near VR, and airspeed suddenly decreases, there may not be sufficient runway left to accelerate back to the normal VR. If there is insufficient runway left to stop, initiate a normal rotation at least 2000 feet before the end of the runway even if airspeed is low. Higher than normal attitudes may be needed to lift-off in the remaining runway.

Approach and Landing

- Use flaps 30 for landing.
- Establish a stabilized approach no lower than 1000 feet above the airport to improve windshear recognition capability.
- Use the most suitable runway that avoids the areas of suspected windshear and is compatible with crosswind or tailwind limitations. Use ILS G/S, VNAV path or VASI/PAPI indications to detect flight path deviations and help with timely detection of windshear.
- If the autothrottle is disengaged, or is planned to be disengaged prior to landing, add an appropriate airspeed correction (correction applied in the same manner as gust), up to a maximum of 20 knots.
- Avoid large thrust reductions or trim changes in response to sudden airspeed increases as these may be followed by airspeed decreases.
- Crosscheck flight director commands using vertical flight path instruments.



- Crew coordination and awareness are very important, particularly at night or in marginal weather conditions. Closely monitor the vertical flight path instruments such as vertical speed, altimeters, and glideslope displacement. The pilot not flying should call out any deviations from normal. Use of the autopilot and autothrottle for the approach may provide more monitoring and recognition time.

Recovery

Accomplish the Windshear Escape Maneuver found in the Non-Normal Maneuvers section of this manual.



737-600 CFM56-7B20 KG JAA JAR CATD

Takeoff PD.10.1

- Takeoff Field Corrections - Dry Runway PD.10.1
- Takeoff Field & Climb Limit Weights - Dry Runway PD.10.2
- Takeoff Field Corrections - Wet Runway PD.10.5
- Takeoff Field & Climb Limit Weights - Wet Runway PD.10.6
- Takeoff Obstacle Limit Weight PD.10.9

Enroute PD.11.1

- Long Range Cruise Maximum Operating Altitude PD.11.1
- Long Range Cruise Trip Fuel and Time PD.11.2
- Long Range Cruise Step Climb PD.11.4
- Short Trip Fuel and Time PD.11.5
- Holding Planning PD.11.5
- Flight Crew Oxygen Requirements PD.11.6
- Net Level Off Weight PD.11.7
- Long Range Cruise Critical Fuel Reserves PD.11.8

Landing PD.12.1

- Landing Field Limit Weight - Dry Runway PD.12.1
- Landing Field Limit Weight - Wet Runway PD.12.3
- Landing Climb Limit Weight PD.12.5
- Go-Around Climb Gradient PD.12.6
- Quick Turnaround Limit Weight PD.12.7

Text PD.13.1

- Introduction PD.13.1
- Takeoff PD.13.1
- Enroute PD.13.2
- Landing PD.13.5

737-700 CFM56-7B20 KG JAA JAR CATA

Takeoff	PD.20.1
Takeoff Field Corrections - Dry Runway	PD.20.1
Takeoff Field & Climb Limit Weights - Dry Runway	PD.20.2
Takeoff Field Corrections - Wet Runway	PD.20.4
Takeoff Field & Climb Limit Weights - Wet Runway	PD.20.5
Takeoff Obstacle Limit Weight	PD.20.7
Enroute	PD.21.1
Long Range Cruise Maximum Operating Altitude	PD.21.1
Long Range Cruise Trip Fuel and Time	PD.21.2
Long Range Cruise Step Climb	PD.21.4
Short Trip Fuel and Time	PD.21.5
Holding Planning	PD.21.5
Flight Crew Oxygen Requirements	PD.21.6
Net Level Off Weight	PD.21.7
Long Range Cruise Critical Fuel Reserves	PD.21.8
Landing	PD.22.1
Landing Field Limit Weight - Dry Runway	PD.22.1
Landing Field Limit Weight - Wet Runway	PD.22.3
Landing Climb Limit Weight	PD.22.5
Go-Around Climb Gradient	PD.22.6
Quick Turnaround Limit Weight	PD.22.7
Text	PD.23.1
Introduction	PD.23.1
Takeoff	PD.23.1
Enroute	PD.23.2
Landing	PD.23.5

737 Flight Crew Operations Manual

737-800 CFM56-7B26 KG JAA JAR CATC

Takeoff	PD.30.1
Takeoff Field Corrections - Dry Runway	PD.30.1
Takeoff Field & Climb Limit Weights - Dry Runway	PD.30.2
Takeoff Field Corrections - Wet Runway	PD.30.4
Takeoff Field & Climb Limit Weights - Wet Runway	PD.30.5
Takeoff Obstacle Limit Weight	PD.30.7
Enroute	PD.31.1
Long Range Cruise Maximum Operating Altitude	PD.31.1
Long Range Cruise Trip Fuel and Time	PD.31.2
Long Range Cruise Step Climb	PD.31.4
Short Trip Fuel and Time	PD.31.5
Holding Planning	PD.31.5
Flight Crew Oxygen Requirements	PD.31.6
Net Level Off Weight	PD.31.7
Long Range Cruise Critical Fuel Reserves	PD.31.8
Landing	PD.32.1
Landing Field Limit Weight	PD.32.1
Landing Climb Limit Weight	PD.32.2
Go-Around Climb Gradient	PD.32.3
Quick Turnaround Limit Weight	PD.32.4
Text	PD.33.1
Introduction	PD.33.1
Takeoff	PD.33.1
Enroute	PD.33.2
Landing	PD.33.5



Intentionally
Blank

Performance Dispatch

Chapter PD

Takeoff

Section 10

Takeoff Field Corrections - Dry Runway

Slope Corrections

FIELD LENGTH AVAILABLE (M)	SLOPE CORRECTED FIELD LENGTH (M)								
	RUNWAY SLOPE (%)								
	-2.0	-1.5	-1.0	-0.5	0.0	0.5	1.0	1.5	2.0
1200	1200	1200	1200	1200	1200	1170	1140	1110	1090
1400	1400	1400	1400	1400	1400	1360	1310	1270	1230
1600	1650	1640	1620	1610	1600	1540	1490	1430	1370
1800	1890	1870	1850	1820	1800	1730	1660	1590	1520
2000	2140	2100	2070	2030	2000	1920	1830	1750	1660
2200	2380	2340	2290	2250	2200	2100	2000	1900	1810
2400	2630	2570	2510	2460	2400	2290	2180	2060	1950
2600	2870	2800	2740	2670	2600	2470	2350	2220	2090
2800	3120	3040	2960	2880	2800	2660	2520	2380	2240
3000	3360	3270	3180	3090	3000	2850	2690	2540	2380
3200	3610	3510	3400	3300	3200	3030	2860	2690	2530
3400	3850	3740	3630	3510	3400	3220	3040	2850	2670
3600	4100	3970	3850	3720	3600	3400	3210	3010	2810
3800	4340	4210	4070	3940	3800	3590	3380	3170	2960
4000	4590	4440	4290	4150	4000	3780	3550	3330	3100
4200	4830	4670	4520	4360	4200	3960	3720	3490	3250
4400	5080	4910	4740	4570	4400	4150	3900	3640	3390
4600	5320	5140	4960	4780	4600	4330	4070	3800	3530
4800	5560	5370	5180	4990	4800	4520	4240	3960	3680
5000	5810	5610	5400	5200	5000	4710	4410	4120	3820

Wind Corrections

SLOPE CORR'D FIELD LENGTH (M)	SLOPE & WIND CORRECTED FIELD LENGTH (M)							
	WIND COMPONENT (KTS)							
	-15	-10	-5	0	10	20	30	40
1200	850	970	1080	1200	1280	1350	1420	1500
1400	1030	1150	1280	1400	1480	1560	1640	1720
1600	1200	1340	1470	1600	1680	1760	1850	1940
1800	1380	1520	1660	1800	1880	1970	2060	2160
2000	1560	1700	1850	2000	2080	2170	2280	2390
2200	1730	1890	2040	2200	2280	2380	2490	2610
2400	1910	2070	2240	2400	2490	2590	2700	2830
2600	2090	2260	2430	2600	2690	2790	2910	3050
2800	2260	2440	2620	2800	2890	3000	3130	3280
3000	2440	2630	2810	3000	3090	3200	3340	3500
3200	2610	2810	3000	3200	3290	3410	3550	3720
3400	2790	2990	3200	3400	3490	3620	3770	3940
3600	2970	3180	3390	3600	3700	3820	3980	4170
3800	3140	3360	3580	3800	3900	4030	4190	4390
4000	3320	3550	3770	4000	4100	4240	4410	4610
4200	3500	3730	3970	4200	4300	4440	4620	4830
4400	3670	3910	4160	4400	4500	4650	4830	5060
4600	3850	4100	4350	4600	4710	4850	5050	5280
4800	4020	4280	4540	4800	4910	5060	5260	5500
5000	4200	4470	4730	5000	5110	5270	5470	5730

Takeoff Field & Climb Limit Weights - Dry Runway

Flaps 5

Sea Level Pressure Altitude

CORR'D FIELD LENGTH (M)	FIELD LIMIT WEIGHT (1000 KG)										
	OAT (°C)										
	-40	10	14	18	22	26	30	38	42	46	50
1250	54.9	51.3	51.0	50.7	50.4	50.1	49.8	46.8	45.4	44.0	42.7
1400	58.1	54.2	53.9	53.6	53.3	53.0	52.7	49.5	48.0	46.6	45.2
1600	62.1	58.0	57.7	57.4	57.0	56.7	56.4	53.0	51.4	49.8	48.3
1800	65.9	61.6	61.2	60.9	60.5	60.2	59.8	56.2	54.6	52.9	51.3
2000	69.8	65.2	64.9	64.5	64.1	63.7	63.4	59.6	57.8	56.0	54.3
2200	72.5	68.4	68.0	67.7	67.3	66.9	66.5	62.5	60.6	58.7	56.9
2400	72.5	71.1	70.7	70.3	69.9	69.5	69.1	64.9	62.9	61.0	59.1
2600	72.5	72.5	72.5	72.5	72.2	71.8	71.4	67.0	65.0	62.9	61.0
2800	72.5	72.5	72.5	72.5	72.5	72.5	72.5	69.1	67.0	64.9	62.8
3000	72.5	72.5	72.5	72.5	72.5	72.5	72.5	71.2	68.9	66.8	64.7
3200	72.5	72.5	72.5	72.5	72.5	72.5	72.5	72.5	70.9	68.6	66.4
3400	72.5	72.5	72.5	72.5	72.5	72.5	72.5	72.5	72.5	70.4	68.2
3600	72.5	72.5	72.5	72.5	72.5	72.5	72.5	72.5	72.5	72.2	69.9
3800	72.5	72.5	72.5	72.5	72.5	72.5	72.5	72.5	72.5	72.5	71.5
4000	72.5	72.5	72.5	72.5	72.5	72.5	72.5	72.5	72.5	72.5	72.5
4200	72.5	72.5	72.5	72.5	72.5	72.5	72.5	72.5	72.5	72.5	72.5
4400	72.5	72.5	72.5	72.5	72.5	72.5	72.5	72.5	72.5	72.5	72.5
4600	72.5	72.5	72.5	72.5	72.5	72.5	72.5	72.5	72.5	72.5	72.5
CLIMB LIMIT WT (1000 KG)	62.3	61.9	61.8	61.7	61.6	61.5	61.4	56.7	54.4	52.2	50.1

2000 FT Pressure Altitude

CORR'D FIELD LENGTH (M)	FIELD LIMIT WEIGHT (1000 KG)										
	OAT (°C)										
	-40	10	14	18	22	26	30	38	42	46	50
1250	53.1	49.6	49.3	49.0	48.7	48.4	48.0	45.1	43.8	42.5	41.3
1400	56.2	52.4	52.1	51.8	51.5	51.2	50.8	47.8	46.4	45.0	43.6
1600	60.1	56.1	55.8	55.4	55.1	54.8	54.3	51.1	49.6	48.1	46.7
1800	63.8	59.5	59.2	58.9	58.5	58.1	57.7	54.2	52.6	51.1	49.6
2000	67.6	63.1	62.7	62.3	62.0	61.6	61.1	57.4	55.7	54.1	52.5
2200	70.9	66.2	65.8	65.4	65.0	64.6	64.1	60.2	58.5	56.7	55.0
2400	72.5	68.8	68.4	67.9	67.5	67.1	66.6	62.6	60.7	58.9	57.1
2600	72.5	71.0	70.6	70.2	69.8	69.3	68.8	64.6	62.7	60.7	58.9
2800	72.5	72.5	72.5	72.4	72.0	71.5	70.9	66.6	64.6	62.6	60.7
3000	72.5	72.5	72.5	72.5	72.5	72.5	72.5	68.5	66.5	64.4	62.4
3200	72.5	72.5	72.5	72.5	72.5	72.5	72.5	70.4	68.3	66.1	64.1
3400	72.5	72.5	72.5	72.5	72.5	72.5	72.5	72.3	70.1	67.9	65.8
3600	72.5	72.5	72.5	72.5	72.5	72.5	72.5	72.5	71.8	69.5	67.4
3800	72.5	72.5	72.5	72.5	72.5	72.5	72.5	72.5	72.5	71.2	69.0
4000	72.5	72.5	72.5	72.5	72.5	72.5	72.5	72.5	72.5	72.5	70.5
4200	72.5	72.5	72.5	72.5	72.5	72.5	72.5	72.5	72.5	72.5	72.0
4400	72.5	72.5	72.5	72.5	72.5	72.5	72.5	72.5	72.5	72.5	72.5
4600	72.5	72.5	72.5	72.5	72.5	72.5	72.5	72.5	72.5	72.5	72.5
CLIMB LIMIT WT (1000 KG)	61.8	61.3	61.2	61.2	61.1	61.0	60.7	55.9	53.7	51.4	49.4

With engine bleed for packs off, increase field limit weight by 550 kg and climb limit weight by 1250 kg.

With engine anti-ice on, decrease field limit weight by 150 kg and climb limit weight by 200 kg.

With engine and wing anti-ice on (optional system), decrease field limit weight by 550 kg and climb limit weight by 800 kg.

Takeoff Field & Climb Limit Weights - Dry Runway

Flaps 5

4000 FT Pressure Altitude

CORR'D FIELD LENGTH (M)	FIELD LIMIT WEIGHT (1000 KG)										
	OAT (°C)										
	-40	10	14	18	22	26	30	38	42	46	50
1250	51.2	47.6	47.2	46.8	46.5	46.2	45.8	43.4	42.1	40.9	39.8
1400	54.2	50.4	49.9	49.5	49.2	48.9	48.5	45.9	44.6	43.3	42.2
1600	58.0	53.9	53.4	53.0	52.7	52.3	51.8	49.2	47.7	46.3	45.1
1800	61.5	57.2	56.7	56.3	55.9	55.6	55.0	52.2	50.6	49.2	47.9
2000	65.2	60.6	60.1	59.6	59.2	58.8	58.3	55.3	53.6	52.1	50.7
2200	68.4	63.5	63.0	62.5	62.1	61.7	61.1	57.9	56.2	54.6	53.1
2400	71.1	66.0	65.5	64.9	64.5	64.1	63.5	60.2	58.3	56.7	55.2
2600	72.5	68.2	67.6	67.1	66.6	66.2	65.6	62.1	60.2	58.5	56.9
2800	72.5	70.3	69.7	69.1	68.7	68.2	67.6	64.0	62.0	60.2	58.5
3000	72.5	72.4	71.8	71.2	70.7	70.3	69.6	65.8	63.8	61.9	60.2
3200	72.5	72.5	72.5	72.5	72.5	72.2	71.5	67.7	65.5	63.6	61.9
3400	72.5	72.5	72.5	72.5	72.5	72.5	72.5	69.4	67.3	65.3	63.5
3600	72.5	72.5	72.5	72.5	72.5	72.5	72.5	71.2	68.9	66.9	65.0
3800	72.5	72.5	72.5	72.5	72.5	72.5	72.5	72.5	70.5	68.4	66.5
4000	72.5	72.5	72.5	72.5	72.5	72.5	72.5	72.5	72.1	69.9	68.0
4200	72.5	72.5	72.5	72.5	72.5	72.5	72.5	72.5	72.5	71.4	69.4
4400	72.5	72.5	72.5	72.5	72.5	72.5	72.5	72.5	72.5	72.5	70.8
4600	72.5	72.5	72.5	72.5	72.5	72.5	72.5	72.5	72.5	72.5	72.1
CLIMB LIMIT WT (1000 KG)	60.6	60.2	60.1	60.1	60.0	59.9	59.5	54.9	52.6	50.6	48.8

6000 FT Pressure Altitude

CORR'D FIELD LENGTH (M)	FIELD LIMIT WEIGHT (1000 KG)										
	OAT (°C)										
	-40	10	14	18	22	26	30	38	42	46	50
1250	48.4	44.7	44.4	44.1	43.9	43.5	42.4	40.1	39.1	38.1	37.2
1400	51.2	47.3	47.0	46.7	46.4	46.0	44.9	42.5	41.3	40.3	39.3
1600	54.7	50.6	50.3	50.0	49.7	49.2	48.0	45.4	44.2	43.1	42.1
1800	58.1	53.7	53.4	53.0	52.7	52.3	51.0	48.2	46.9	45.8	44.7
2000	61.6	56.9	56.5	56.2	55.8	55.3	54.0	51.1	49.7	48.5	47.3
2200	64.6	59.6	59.3	58.9	58.5	58.0	56.6	53.5	52.1	50.8	49.6
2400	67.1	61.9	61.6	61.2	60.8	60.3	58.8	55.6	54.1	52.7	51.4
2600	69.3	63.9	63.5	63.1	62.8	62.2	60.6	57.3	55.7	54.3	53.0
2800	71.5	65.9	65.5	65.1	64.7	64.1	62.5	59.0	57.4	55.9	54.5
3000	72.5	67.8	67.4	67.0	66.6	65.9	64.3	60.7	59.0	57.5	56.0
3200	72.5	69.7	69.3	68.8	68.4	67.8	66.0	62.3	60.6	59.0	57.5
3400	72.5	71.5	71.1	70.6	70.2	69.5	67.8	64.0	62.1	60.5	59.0
3600	72.5	72.5	72.5	72.4	71.9	71.2	69.4	65.5	63.7	62.0	60.4
3800	72.5	72.5	72.5	72.5	72.5	72.5	71.0	67.0	65.1	63.4	61.8
4000	72.5	72.5	72.5	72.5	72.5	72.5	72.5	68.5	66.6	64.8	63.1
4200	72.5	72.5	72.5	72.5	72.5	72.5	72.5	69.9	68.0	66.2	64.5
4400	72.5	72.5	72.5	72.5	72.5	72.5	72.5	71.3	69.3	67.5	65.7
4600	72.5	72.5	72.5	72.5	72.5	72.5	72.5	72.5	70.6	68.8	67.0
CLIMB LIMIT WT (1000 KG)	57.9	57.4	57.4	57.3	57.2	56.8	54.7	50.6	48.7	47.1	45.5

With engine bleed for packs off, increase field limit weight by 550 kg and climb limit weight by 1250 kg.

With engine anti-ice on, decrease field limit weight by 150 kg and climb limit weight by 200 kg.

With engine and wing anti-ice on (optional system), decrease field limit weight by 550 kg and climb limit weight by 800 kg.

Takeoff Field & Climb Limit Weights - Dry Runway

Flaps 5

8000 FT Pressure Altitude

CORR'D FIELD LENGTH (M)	FIELD LIMIT WEIGHT (1000 KG)										
	OAT (°C)										
	-40	10	14	18	22	26	30	38	42	46	50
1250	45.5	42.2	41.9	41.6	40.6	39.6	38.5	36.3	35.4	34.5	33.6
1400	48.1	44.6	44.3	44.0	43.0	41.8	40.7	38.4	37.5	36.5	35.6
1600	51.5	47.7	47.4	47.1	46.0	44.8	43.6	41.1	40.1	39.1	38.0
1800	54.7	50.7	50.4	50.0	48.8	47.5	46.3	43.7	42.5	41.5	40.4
2000	57.9	53.6	53.3	52.9	51.7	50.3	49.0	46.2	45.0	43.9	42.7
2200	60.7	56.2	55.9	55.5	54.2	52.8	51.3	48.4	47.2	46.0	44.8
2400	63.1	58.4	58.0	57.6	56.2	54.8	53.3	50.3	49.0	47.7	46.4
2600	65.1	60.3	59.9	59.5	58.0	56.4	54.9	51.8	50.4	49.1	47.8
2800	67.1	62.1	61.7	61.2	59.7	58.1	56.5	53.2	51.8	50.4	49.1
3000	69.1	63.9	63.5	63.0	61.4	59.8	58.1	54.7	53.3	51.8	50.4
3200	71.0	65.6	65.2	64.7	63.1	61.4	59.7	56.2	54.7	53.2	51.8
3400	72.5	67.3	66.9	66.4	64.7	63.0	61.2	57.6	56.1	54.5	53.0
3600	72.5	69.0	68.5	68.0	66.3	64.5	62.7	59.0	57.4	55.8	54.3
3800	72.5	70.6	70.1	69.6	67.8	66.0	64.1	60.3	58.7	57.1	55.5
4000	72.5	72.1	71.7	71.2	69.3	67.5	65.5	61.7	60.0	58.4	56.7
4200	72.5	72.5	72.5	72.5	70.8	68.9	66.9	62.9	61.2	59.6	57.9
4400	72.5	72.5	72.5	72.5	72.2	70.2	68.2	64.2	62.4	60.7	59.0
4600	72.5	72.5	72.5	72.5	72.5	71.5	69.5	65.4	63.6	61.9	60.1
CLIMB LIMIT WT (1000 KG)	55.2	54.7	54.7	54.5	52.6	50.7	48.7	45.0	43.4	41.9	40.4

10000 FT Pressure Altitude

CORR'D FIELD LENGTH (M)	FIELD LIMIT WEIGHT (1000 KG)										
	OAT (°C)										
	-40	10	14	18	22	26	30	38	42	46	50
1250	42.8	39.6	38.5	37.9	36.5	35.5	34.4	32.6	31.7	30.9	29.4
1400	45.2	41.9	40.8	39.7	38.6	37.5	36.4	34.5	33.6	32.7	31.7
1600	48.4	44.8	43.6	42.4	41.3	40.1	38.9	36.9	35.9	34.9	34.0
1800	51.4	47.6	46.3	45.0	43.9	42.6	41.3	39.1	38.1	37.1	36.1
2000	54.4	50.4	49.0	47.7	46.4	45.1	43.8	41.4	40.3	39.3	38.2
2200	57.0	52.8	51.4	50.0	48.7	47.3	45.8	43.4	42.3	41.1	40.0
2400	59.2	54.8	53.4	51.9	50.5	49.0	47.5	45.0	43.8	42.6	41.4
2600	61.1	56.5	55.0	53.4	52.0	50.5	48.9	46.3	45.0	43.8	42.5
2800	63.0	58.2	56.6	55.0	53.5	51.9	50.3	47.5	46.2	44.9	43.6
3000	64.8	59.9	58.2	56.5	55.0	53.3	51.7	48.8	47.5	46.1	44.8
3200	66.6	61.5	59.8	58.0	56.4	54.8	53.0	50.1	48.7	47.3	45.9
3400	68.3	63.1	61.3	59.5	57.9	56.1	54.4	51.3	49.9	48.5	47.0
3600	70.0	64.6	62.8	61.0	59.3	57.5	55.7	52.5	51.1	49.6	48.1
3800	71.6	66.1	64.2	62.4	60.6	58.8	56.9	53.7	52.2	50.7	49.2
4000	72.5	67.5	65.6	63.7	61.9	60.1	58.2	54.9	53.3	51.8	50.3
4200	72.5	69.0	67.0	65.1	63.2	61.3	59.4	56.0	54.4	52.9	51.3
4400	72.5	70.3	68.3	66.3	64.5	62.5	60.5	57.1	55.5	53.9	52.3
4600	72.5	71.6	69.6	67.6	65.7	63.7	61.7	58.2	56.5	54.9	53.2
CLIMB LIMIT WT (1000 KG)	52.4	51.9	50.0	48.0	46.2	44.4	42.5	39.5	38.1	36.7	35.3

With engine bleed for packs off, increase field limit weight by 550 kg and climb limit weight by 1250 kg.

With engine anti-ice on, decrease field limit weight by 150 kg and climb limit weight by 200 kg.

With engine and wing anti-ice on (optional system), decrease field limit weight by 550 kg and climb limit weight by 800 kg.

Takeoff Field Corrections - Wet Runway

Slope Corrections

FIELD LENGTH AVAILABLE (M)	SLOPE CORRECTED FIELD LENGTH (M)								
	RUNWAY SLOPE (%)								
	-2.0	-1.5	-1.0	-0.5	0.0	0.5	1.0	1.5	2.0
1200	1230	1220	1220	1210	1200	1180	1160	1140	1130
1400	1460	1450	1430	1420	1400	1370	1330	1300	1270
1600	1700	1670	1650	1620	1600	1550	1510	1460	1410
1800	1930	1900	1860	1830	1800	1740	1680	1610	1550
2000	2160	2120	2080	2040	2000	1920	1850	1770	1700
2200	2400	2350	2300	2250	2200	2110	2020	1930	1840
2400	2630	2570	2510	2460	2400	2300	2190	2090	1980
2600	2860	2800	2730	2670	2600	2480	2360	2240	2120
2800	3090	3020	2950	2870	2800	2670	2530	2400	2270
3000	3330	3250	3160	3080	3000	2850	2700	2560	2410
3200	3560	3470	3380	3290	3200	3040	2880	2710	2550
3400	3790	3700	3600	3500	3400	3220	3050	2870	2690
3600	4030	3920	3810	3710	3600	3410	3220	3030	2840
3800	4260	4150	4030	3920	3800	3590	3390	3180	2980
4000	4490	4370	4250	4120	4000	3780	3560	3340	3120
4200	4730	4590	4460	4330	4200	3970	3730	3500	3260
4400	4960	4820	4680	4540	4400	4150	3900	3660	3410
4600	5190	5040	4900	4750	4600	4340	4070	3810	3550
4800	5430	5270	5110	4960	4800	4520	4250	3970	3690
5000	5660	5490	5330	5160	5000	4710	4420	4130	3830

Wind Corrections

SLOPE CORR'D FIELD LENGTH (M)	SLOPE & WIND CORRECTED FIELD LENGTH (M)							
	WIND COMPONENT (KTS)							
	-15	-10	-5	0	10	20	30	40
1200	830	950	1080	1200	1280	1370	1460	1550
1400	1000	1130	1270	1400	1490	1580	1680	1780
1600	1160	1310	1450	1600	1690	1790	1890	2000
1800	1330	1490	1640	1800	1900	2000	2110	2230
2000	1500	1670	1830	2000	2100	2210	2330	2450
2200	1670	1850	2020	2200	2310	2420	2550	2680
2400	1840	2030	2210	2400	2510	2630	2760	2910
2600	2010	2200	2400	2600	2720	2840	2980	3130
2800	2170	2380	2590	2800	2920	3050	3200	3360
3000	2340	2560	2780	3000	3120	3260	3420	3590
3200	2510	2740	2970	3200	3330	3470	3640	3810
3400	2680	2920	3160	3400	3530	3680	3850	4040
3600	2850	3100	3350	3600	3740	3900	4070	4260
3800	3020	3280	3540	3800	3940	4110	4290	4490
4000	3190	3460	3730	4000	4150	4320	4510	4720
4200	3350	3640	3920	4200	4350	4530	4720	4940
4400	3520	3810	4110	4400	4560	4740	4940	5170
4600	3690	3990	4300	4600	4760	4950	5160	5400
4800	3860	4170	4490	4800	4970	5160	5380	5620
5000	4030	4350	4680	5000	5170	5370	5590	5850

737 Flight Crew Operations Manual

Takeoff Field & Climb Limit Weights - Wet Runway

Flaps 5

Sea Level Pressure Altitude

CORR'D FIELD LENGTH (M)	FIELD LIMIT WEIGHT (1000 KG)										
	OAT (°C)										
	-40	10	14	18	22	26	30	38	42	46	50
1400	58.7	54.1	53.8	53.4	53.1	52.7	52.4	49.4	48.0	46.7	45.4
1600	62.7	57.8	57.4	57.0	56.7	56.3	55.9	52.7	51.3	49.9	48.5
1800	66.4	61.2	60.8	60.4	60.0	59.6	59.2	55.8	54.3	52.8	51.4
2000	69.8	64.3	63.8	63.4	63.0	62.6	62.2	58.6	57.0	55.4	53.9
2200	72.5	67.4	66.9	66.5	66.0	65.6	65.2	61.4	59.7	58.1	56.5
2400	72.5	70.3	69.8	69.4	68.9	68.5	68.0	64.1	62.3	60.6	59.0
2600	72.5	72.5	72.3	71.8	71.4	70.9	70.4	66.4	64.5	62.7	61.0
2800	72.5	72.5	72.5	72.5	72.5	72.5	72.5	68.5	66.7	64.8	63.0
3000	72.5	72.5	72.5	72.5	72.5	72.5	72.5	70.8	68.8	66.9	65.0
3200	72.5	72.5	72.5	72.5	72.5	72.5	72.5	72.5	70.8	68.8	66.9
3400	72.5	72.5	72.5	72.5	72.5	72.5	72.5	72.5	72.5	70.7	68.7
3600	72.5	72.5	72.5	72.5	72.5	72.5	72.5	72.5	72.5	72.5	70.5
3800	72.5	72.5	72.5	72.5	72.5	72.5	72.5	72.5	72.5	72.5	72.2
4000	72.5	72.5	72.5	72.5	72.5	72.5	72.5	72.5	72.5	72.5	72.5
4200	72.5	72.5	72.5	72.5	72.5	72.5	72.5	72.5	72.5	72.5	72.5
4400	72.5	72.5	72.5	72.5	72.5	72.5	72.5	72.5	72.5	72.5	72.5
4600	72.5	72.5	72.5	72.5	72.5	72.5	72.5	72.5	72.5	72.5	72.5
4800	72.5	72.5	72.5	72.5	72.5	72.5	72.5	72.5	72.5	72.5	72.5
CLIMB LIMIT WT (1000 KG)	62.3	61.9	61.8	61.7	61.6	61.5	61.4	56.7	54.4	52.2	50.1

2000 FT Pressure Altitude

CORR'D FIELD LENGTH (M)	FIELD LIMIT WEIGHT (1000 KG)										
	OAT (°C)										
	-40	10	14	18	22	26	30	38	42	46	50
1400	56.6	52.0	51.7	51.4	51.0	50.7	50.1	47.4	46.1	44.8	43.6
1600	60.5	55.6	55.2	54.9	54.5	54.2	53.5	50.6	49.3	47.9	46.6
1800	64.0	58.8	58.4	58.1	57.7	57.3	56.6	53.6	52.1	50.7	49.3
2000	67.3	61.8	61.4	61.0	60.6	60.2	59.5	56.3	54.7	53.2	51.8
2200	70.5	64.8	64.3	63.9	63.5	63.1	62.3	59.0	57.4	55.7	54.3
2400	72.5	67.6	67.2	66.7	66.3	65.9	65.0	61.5	59.9	58.2	56.6
2600	72.5	70.0	69.5	69.1	68.6	68.2	67.3	63.7	61.9	60.2	58.6
2800	72.5	72.3	71.9	71.4	70.9	70.4	69.6	65.8	64.0	62.1	60.5
3000	72.5	72.5	72.5	72.5	72.5	72.5	71.9	67.9	66.0	64.1	62.4
3200	72.5	72.5	72.5	72.5	72.5	72.5	72.5	69.9	67.9	66.0	64.2
3400	72.5	72.5	72.5	72.5	72.5	72.5	72.5	71.8	69.8	67.8	65.9
3600	72.5	72.5	72.5	72.5	72.5	72.5	72.5	72.5	71.6	69.5	67.6
3800	72.5	72.5	72.5	72.5	72.5	72.5	72.5	72.5	72.5	71.2	69.2
4000	72.5	72.5	72.5	72.5	72.5	72.5	72.5	72.5	72.5	72.5	70.8
4200	72.5	72.5	72.5	72.5	72.5	72.5	72.5	72.5	72.5	72.5	72.4
4400	72.5	72.5	72.5	72.5	72.5	72.5	72.5	72.5	72.5	72.5	72.5
4600	72.5	72.5	72.5	72.5	72.5	72.5	72.5	72.5	72.5	72.5	72.5
4800	72.5	72.5	72.5	72.5	72.5	72.5	72.5	72.5	72.5	72.5	72.5
CLIMB LIMIT WT (1000 KG)	61.8	61.3	61.2	61.2	61.1	61.0	60.7	55.9	53.7	51.4	49.4

With engine bleed for packs off, increase field limit weight by 550 kg and climb limit weight by 1250 kg.

With engine anti-ice on, decrease field limit weight by 150 kg and climb limit weight by 200 kg.

With engine and wing anti-ice on (optional system), decrease field limit weight by 500 kg and climb limit weight by 800 kg.

Takeoff Field & Climb Limit Weights - Wet Runway

Flaps 5

4000 FT Pressure Altitude

CORR'D FIELD LENGTH (M)	FIELD LIMIT WEIGHT (1000 KG)										
	OAT (°C)										
	-40	10	14	18	22	26	30	38	42	46	50
1400	54.3	49.6	49.3	48.9	48.6	48.3	47.8	45.4	44.1	43.0	41.9
1600	58.0	53.0	52.6	52.3	51.9	51.6	51.1	48.5	47.2	45.9	44.8
1800	61.4	56.1	55.7	55.3	55.0	54.6	54.1	51.3	49.9	48.6	47.4
2000	64.5	58.9	58.5	58.1	57.7	57.4	56.8	53.9	52.4	51.0	49.8
2200	67.6	61.7	61.3	60.9	60.5	60.1	59.5	56.5	54.9	53.4	52.1
2400	70.5	64.4	64.0	63.5	63.1	62.7	62.1	58.9	57.3	55.8	54.4
2600	72.5	66.7	66.2	65.8	65.4	64.9	64.3	61.0	59.3	57.7	56.3
2800	72.5	68.9	68.4	67.9	67.5	67.1	66.4	63.0	61.2	59.5	58.1
3000	72.5	71.1	70.6	70.2	69.7	69.3	68.6	65.0	63.1	61.4	59.9
3200	72.5	72.5	72.5	72.2	71.7	71.3	70.6	66.9	64.9	63.2	61.6
3400	72.5	72.5	72.5	72.5	72.5	72.5	72.5	68.7	66.7	64.9	63.2
3600	72.5	72.5	72.5	72.5	72.5	72.5	72.5	70.4	68.4	66.5	64.9
3800	72.5	72.5	72.5	72.5	72.5	72.5	72.5	72.2	70.1	68.2	66.4
4000	72.5	72.5	72.5	72.5	72.5	72.5	72.5	72.5	71.7	69.7	68.0
4200	72.5	72.5	72.5	72.5	72.5	72.5	72.5	72.5	72.5	71.3	69.4
4400	72.5	72.5	72.5	72.5	72.5	72.5	72.5	72.5	72.5	72.5	70.9
4600	72.5	72.5	72.5	72.5	72.5	72.5	72.5	72.5	72.5	72.5	72.3
4800	72.5	72.5	72.5	72.5	72.5	72.5	72.5	72.5	72.5	72.5	72.3
CLIMB LIMIT WT (1000 KG)	60.6	60.2	60.1	60.1	60.0	59.9	59.5	54.9	52.6	50.6	48.8

6000 FT Pressure Altitude

CORR'D FIELD LENGTH (M)	FIELD LIMIT WEIGHT (1000 KG)										
	OAT (°C)										
	-40	10	14	18	22	26	30	38	42	46	50
1400	51.1	46.7	46.4	46.1	45.8	45.3	44.2	42.0	40.9	40.0	39.1
1600	54.6	49.9	49.5	49.2	48.9	48.4	47.3	44.8	43.7	42.7	41.7
1800	57.8	52.8	52.4	52.1	51.7	51.3	50.0	47.5	46.3	45.2	44.2
2000	60.7	55.4	55.0	54.7	54.3	53.8	52.5	49.8	48.6	47.4	46.3
2200	63.6	58.1	57.7	57.3	56.9	56.4	55.0	52.2	50.9	49.7	48.5
2400	66.4	60.6	60.2	59.8	59.4	58.8	57.4	54.5	53.1	51.9	50.7
2600	68.7	62.7	62.3	61.9	61.5	60.9	59.4	56.3	54.9	53.6	52.4
2800	71.0	64.7	64.3	63.9	63.5	62.9	61.3	58.1	56.6	55.3	54.0
3000	72.5	66.8	66.4	65.9	65.5	64.9	63.3	60.0	58.4	57.0	55.7
3200	72.5	68.8	68.3	67.9	67.4	66.8	65.1	61.7	60.1	58.6	57.3
3400	72.5	70.6	70.2	69.7	69.2	68.6	66.8	63.3	61.7	60.2	58.8
3600	72.5	72.5	72.0	71.5	71.0	70.3	68.6	64.9	63.2	61.7	60.3
3800	72.5	72.5	72.5	72.5	72.5	72.0	70.2	66.5	64.8	63.2	61.7
4000	72.5	72.5	72.5	72.5	72.5	72.5	71.9	68.0	66.2	64.7	63.1
4200	72.5	72.5	72.5	72.5	72.5	72.5	72.5	69.5	67.7	66.1	64.5
4400	72.5	72.5	72.5	72.5	72.5	72.5	72.5	71.0	69.1	67.4	65.8
4600	72.5	72.5	72.5	72.5	72.5	72.5	72.5	72.4	70.5	68.8	67.1
4800	72.5	72.5	72.5	72.5	72.5	72.5	72.5	72.5	71.8	70.1	68.4
CLIMB LIMIT WT (1000 KG)	57.9	57.4	57.4	57.3	57.2	56.8	54.7	50.6	48.7	47.1	45.5

With engine bleed for packs off, increase field limit weight by 550 kg and climb limit weight by 1250 kg.
 With engine anti-ice on, decrease field limit weight by 150 kg and climb limit weight by 200 kg.
 With engine and wing anti-ice on (optional system), decrease field limit weight by 500 kg and climb limit weight by 800 kg.

Takeoff Field & Climb Limit Weights - Wet Runway

Flaps 5

8000 FT Pressure Altitude

CORR'D FIELD LENGTH (M)	FIELD LIMIT WEIGHT (1000 KG)										
	OAT (°C)										
	-40	10	14	18	22	26	30	38	42	46	50
1400	47.9	43.9	43.6	43.3	42.3	41.3	40.2	38.1	37.2	36.3	35.4
1600	51.1	46.9	46.6	46.3	45.2	44.1	42.9	40.7	39.7	38.8	37.9
1800	54.1	49.7	49.3	49.0	47.8	46.6	45.4	43.1	42.1	41.1	40.1
2000	56.8	52.1	51.8	51.4	50.2	49.0	47.7	45.2	44.1	43.1	42.0
2200	59.6	54.6	54.3	53.9	52.6	51.3	50.0	47.3	46.2	45.1	44.0
2400	62.2	57.0	56.6	56.2	54.9	53.5	52.1	49.4	48.2	47.1	45.9
2600	64.3	59.0	58.6	58.1	56.8	55.4	53.9	51.1	49.9	48.7	47.5
2800	66.4	60.9	60.5	60.0	58.6	57.1	55.6	52.7	51.4	50.1	48.9
3000	68.6	62.8	62.4	61.9	60.4	58.9	57.3	54.3	52.9	51.6	50.3
3200	70.6	64.6	64.2	63.7	62.2	60.6	59.0	55.8	54.4	53.1	51.7
3400	72.5	66.4	65.9	65.4	63.8	62.2	60.5	57.3	55.8	54.5	53.1
3600	72.5	68.1	67.6	67.1	65.4	63.8	62.1	58.7	57.2	55.8	54.4
3800	72.5	69.7	69.2	68.7	67.0	65.3	63.6	60.1	58.6	57.1	55.7
4000	72.5	71.3	70.8	70.3	68.6	66.8	65.0	61.5	59.9	58.4	56.9
4200	72.5	72.5	72.4	71.8	70.1	68.3	66.4	62.8	61.2	59.7	58.2
4400	72.5	72.5	72.5	72.5	71.5	69.7	67.8	64.1	62.5	60.9	59.4
4600	72.5	72.5	72.5	72.5	72.5	71.1	69.1	65.4	63.7	62.1	60.5
4800	72.5	72.5	72.5	72.5	72.5	72.4	70.4	66.6	64.9	63.3	61.7
CLIMB LIMIT WT (1000 KG)	55.2	54.7	54.7	54.5	52.6	50.7	48.7	45.0	43.4	41.9	40.4

10000 FT Pressure Altitude

CORR'D FIELD LENGTH (M)	FIELD LIMIT WEIGHT (1000 KG)										
	OAT (°C)										
	-40	10	14	18	22	26	30	38	42	46	50
1400	44.9	41.2	40.1	39.1	38.1	37.1	36.1	34.3	33.5	32.6	31.8
1600	48.0	44.0	42.9	41.8	40.7	39.6	38.5	36.6	35.7	34.8	33.9
1800	50.8	46.6	45.4	44.2	43.1	41.9	40.8	38.8	37.8	36.9	35.9
2000	53.3	48.9	47.6	46.4	45.2	44.0	42.8	40.6	39.6	38.6	37.6
2200	55.8	51.2	49.9	48.6	47.3	46.1	44.8	42.6	41.5	40.5	39.4
2400	58.3	53.4	52.1	50.7	49.4	48.1	46.7	44.4	43.3	42.2	41.1
2600	60.3	55.3	53.9	52.4	51.1	49.7	48.3	45.9	44.8	43.6	42.5
2800	62.3	57.0	55.5	54.1	52.6	51.2	49.8	47.3	46.1	44.9	43.7
3000	64.2	58.8	57.3	55.7	54.3	52.8	51.3	48.6	47.4	46.2	45.0
3200	66.1	60.5	58.9	57.3	55.8	54.3	52.7	50.0	48.7	47.4	46.2
3400	67.9	62.1	60.5	58.8	57.3	55.7	54.1	51.3	50.0	48.7	47.4
3600	69.6	63.7	62.0	60.3	58.7	57.1	55.4	52.6	51.2	49.9	48.5
3800	71.3	65.2	63.5	61.7	60.1	58.4	56.7	53.8	52.4	51.0	49.6
4000	72.5	66.7	64.9	63.1	61.5	59.8	58.0	55.0	53.6	52.1	50.7
4200	72.5	68.2	66.3	64.5	62.8	61.0	59.3	56.2	54.7	53.2	51.8
4400	72.5	69.6	67.7	65.9	64.1	62.3	60.5	57.3	55.8	54.3	52.9
4600	72.5	70.9	69.0	67.2	65.4	63.5	61.7	58.4	56.9	55.4	53.9
4800	72.5	72.3	70.3	68.4	66.6	64.7	62.9	59.6	58.0	56.5	54.9
CLIMB LIMIT WT (1000 KG)	52.4	51.9	50.0	48.0	46.2	44.4	42.5	39.5	38.1	36.7	35.3

With engine bleed for packs off, increase field limit weight by 550 kg and climb limit weight by 1250 kg.

With engine anti-ice on, decrease field limit weight by 150 kg and climb limit weight by 200 kg.

With engine and wing anti-ice on (optional system), decrease field limit weight by 500 kg and climb limit weight by 800 kg.

Takeoff Obstacle Limit Weight

Flaps 5

Sea Level, 30°C & Below, Zero Wind

Based on engine bleed for packs on and anti-ice off

Reference Obstacle Limit Weight (1000 KG)

OBSTACLE HEIGHT (M)	DISTANCE FROM BRAKE RELEASE (100 M)													
	25	30	35	40	45	50	55	60	65	70	75	80	85	90
5	62.6	65.1												
20	57.1	60.2	62.3	63.7	64.8	65.7								
40	52.3	55.5	58.0	59.9	61.4	62.5	63.4	64.1	64.7	65.2	65.6	66.0	66.3	66.6
60	48.7	52.1	54.7	56.7	58.4	59.8	60.9	61.8	62.6	63.2	63.8	64.2	64.7	65.0
80	45.9	49.2	51.9	54.1	55.9	57.4	58.6	59.7	60.6	61.3	62.0	62.6	63.1	63.5
100	43.4	46.8	49.6	51.8	53.7	55.2	56.6	57.7	58.7	59.6	60.3	61.0	61.6	62.1
120	41.2	44.7	47.5	49.8	51.7	53.4	54.8	56.0	57.0	58.0	58.8	59.5	60.2	60.8
140		42.8	45.6	48.0	50.0	51.7	53.1	54.4	55.5	56.5	57.4	58.1	58.8	59.5
160		41.1	43.9	46.3	48.3	50.1	51.6	52.9	54.1	55.1	56.0	56.8	57.6	58.3
180		39.5	42.4	44.8	46.9	48.6	50.2	51.5	52.7	53.8	54.8	55.6	56.4	57.1
200			41.0	43.4	45.5	47.3	48.9	50.3	51.5	52.6	53.6	54.5	55.3	56.0
220			39.7	42.1	44.2	46.0	47.6	49.1	50.3	51.5	52.5	53.4	54.2	55.0
240				40.9	43.0	44.8	46.5	47.9	49.2	50.4	51.4	52.4	53.2	54.0
260				39.7	41.8	43.7	45.4	46.8	48.1	49.3	50.4	51.4	52.3	53.1
280					40.8	42.7	44.3	45.8	47.1	48.3	49.4	50.4	51.3	52.2
300					39.8	41.7	43.3	44.8	46.2	47.4	48.5	49.5	50.5	51.3

When using line-up allowances the obstacle distance from brake release must be reduced by the ASDA adjustment.

Obstacle height must be calculated from lowest point of the runway to conservatively account for runway slope.

OAT Adjustments

OAT (°C)	REFERENCE OBSTACLE LIMIT WEIGHT (1000 KG)							
	40	44	48	52	56	60	64	68
30 & BELOW	0	0	0	0	0	0	0	0
32	-0.7	-0.8	-0.9	-1.0	-1.1	-1.1	-1.2	-1.3
34	-1.5	-1.6	-1.8	-2.0	-2.1	-2.3	-2.5	-2.6
36	-2.2	-2.5	-2.7	-2.9	-3.2	-3.4	-3.7	-3.9
38	-2.9	-3.3	-3.6	-3.9	-4.3	-4.6	-4.9	-5.2
40	-3.7	-4.1	-4.5	-4.9	-5.3	-5.7	-6.1	-6.5
42	-4.4	-4.9	-5.3	-5.8	-6.3	-6.8	-7.3	-7.8
44	-5.1	-5.6	-6.2	-6.7	-7.3	-7.9	-8.4	-9.0
46	-5.7	-6.4	-7.0	-7.7	-8.3	-8.9	-9.6	-10.2
48	-6.4	-7.1	-7.9	-8.6	-9.3	-10.0	-10.7	-11.5
50	-7.1	-7.9	-8.7	-9.5	-10.3	-11.1	-11.9	-12.7

Pressure Altitude Adjustments

ALT (FT)	OAT ADJUSTED OBSTACLE LIMIT WEIGHT (1000 KG)							
	40	44	48	52	56	60	64	68
S.L. & BELOW	0	0	0	0	0	0	0	0
1000	-0.7	-0.8	-0.8	-0.8	-0.8	-0.8	-0.8	-0.8
2000	-1.5	-1.5	-1.5	-1.6	-1.6	-1.6	-1.7	-1.7
3000	-2.4	-2.4	-2.5	-2.5	-2.6	-2.6	-2.7	-2.7
4000	-3.3	-3.4	-3.4	-3.5	-3.6	-3.7	-3.7	-3.8
5000	-4.8	-5.0	-5.2	-5.4	-5.6	-5.8	-6.0	-6.3
6000	-6.3	-6.6	-7.0	-7.3	-7.7	-8.0	-8.4	-8.7
7000	-7.9	-8.5	-9.0	-9.6	-10.1	-10.6	-11.2	-11.7
8000	-9.6	-10.3	-11.1	-11.8	-12.5	-13.3	-14.0	-14.7
9000	-11.2	-12.2	-13.2	-14.2	-15.2	-16.2	-17.2	-18.2
10000	-12.7	-14.0	-15.3	-16.5	-17.8	-19.0	-20.3	-21.6

Takeoff Obstacle Limit Weight

Flaps 5

Sea Level, 30°C & Below, Zero Wind

Based on engine bleed for packs on and anti-ice off

Wind Adjustments

WIND (KTS)	OAT & ALT ADJUSTED OBSTACLE LIMIT WEIGHT (1000 KG)							
	40	44	48	52	56	60	64	68
15 TW	-6.9	-6.5	-6.2	-5.8	-5.5	-5.1	-4.8	-4.4
10 TW	-4.6	-4.4	-4.1	-3.9	-3.6	-3.4	-3.2	-2.9
5 TW	-2.3	-2.2	-2.1	-1.9	-1.8	-1.7	-1.6	-1.5
0	0	0	0	0	0	0	0	0
10 HW	0.9	0.8	0.7	0.6	0.6	0.5	0.4	0.3
20 HW	1.8	1.6	1.5	1.3	1.1	0.9	0.8	0.6
30 HW	2.8	2.5	2.2	2.0	1.7	1.4	1.2	0.9
40 HW	3.7	3.4	3.0	2.7	2.3	2.0	1.6	1.2

With engine bleed for packs off, increase weight by 1000 kg.

With engine anti-ice on, decrease weight by 200 kg.

With engine and wing anti-ice on, decrease weight by 850 kg (optional system).

Performance Dispatch

Chapter PD

Enroute

Section 11

Long Range Cruise Maximum Operating Altitude

Max Cruise Thrust

ISA + 10°C and Below

WEIGHT (1000 KG)	OPTIMUM ALT (FT)	TAT (°C)	MARGIN TO INITIAL BUFFET 'G' (BANK ANGLE)				
			1.20 (33°)	1.25 (36°)	1.30 (39°)	1.40 (44°)	1.50 (48°)
70	34300	-14	37700*	37700*	37000	35500	34100
65	35800	-18	39200*	39200*	38600	37100	35700
60	37500	-18	40700*	40700*	40200	38700	37400
55	39300	-18	41000	41000	41000	40500	39200
50	41000	-18	41000	41000	41000	41000	41000
45	41000	-18	41000	41000	41000	41000	41000
40	41000	-18	41000	41000	41000	41000	41000
35	41000	-18	41000	41000	41000	41000	41000

ISA + 15°C

WEIGHT (1000 KG)	OPTIMUM ALT (FT)	TAT (°C)	MARGIN TO INITIAL BUFFET 'G' (BANK ANGLE)				
			1.20 (33°)	1.25 (36°)	1.30 (39°)	1.40 (44°)	1.50 (48°)
70	34300	-9	37000*	37000*	37000	35500	34100
65	35800	-12	38300*	38300*	38300*	37100	35700
60	37500	-13	39800*	39800*	39800*	38700	37400
55	39300	-13	41000	41000	41000	40500	39200
50	41000	-13	41000	41000	41000	41000	41000
45	41000	-13	41000	41000	41000	41000	41000
40	41000	-13	41000	41000	41000	41000	41000
35	41000	-13	41000	41000	41000	41000	41000

ISA + 20°C

WEIGHT (1000 KG)	OPTIMUM ALT (FT)	TAT (°C)	MARGIN TO INITIAL BUFFET 'G' (BANK ANGLE)				
			1.20 (33°)	1.25 (36°)	1.30 (39°)	1.40 (44°)	1.50 (48°)
70	34300	-3	35700*	35700*	35700*	35500	34100
65	35800	-7	37200*	37200*	37200*	37100	35700
60	37500	-7	38700*	38700*	38700*	38700	37400
55	39300	-7	40200*	40200*	40200*	40200*	39200
50	41000	-7	41000	41000	41000	41000	41000
45	41000	-7	41000	41000	41000	41000	41000
40	41000	-7	41000	41000	41000	41000	41000
35	41000	-7	41000	41000	41000	41000	41000

*Denotes altitude thrust limited in level flight, 100 fpm residual rate of climb.

Long Range Cruise Trip Fuel and Time
Ground to Air Miles Conversion

AIR DISTANCE (NM)					GROUND DISTANCE (NM)	AIR DISTANCE (NM)				
HEADWIND COMPONENT (KTS)						TAILWIND COMPONENT (KTS)				
100	80	60	40	20		20	40	60	80	100
278	258	240	225	212	200	190	181	173	166	159
551	513	479	450	424	400	381	364	349	334	322
823	767	717	673	635	600	573	548	524	504	485
1095	1021	955	897	846	800	764	731	700	673	648
1366	1274	1192	1120	1057	1000	955	914	877	842	811
1636	1527	1429	1344	1268	1200	1147	1098	1053	1011	974
1906	1780	1666	1567	1480	1400	1338	1281	1229	1181	1137
2175	2032	1903	1790	1691	1600	1530	1465	1405	1350	1300
2443	2283	2139	2013	1901	1800	1721	1648	1581	1520	1464
2711	2535	2375	2236	2112	2000	1913	1832	1757	1689	1627
2978	2785	2611	2458	2323	2200	2104	2016	1934	1859	1791
3245	3035	2846	2681	2534	2400	2296	2199	2110	2028	1954
3511	3285	3081	2903	2744	2600	2488	2383	2287	2198	2118
3776	3534	3316	3125	2955	2800	2679	2567	2463	2368	2281
4041	3783	3550	3346	3165	3000	2871	2751	2640	2538	2445
4305	4032	3784	3568	3375	3200	3062	2935	2816	2708	2609
4569	4280	4018	3789	3586	3400	3254	3119	2993	2878	2773
4831	4527	4252	4011	3796	3600	3446	3302	3170	3048	2936
5093	4774	4485	4232	4006	3800	3637	3486	3346	3218	3100
5355	5021	4718	4453	4216	4000	3829	3670	3523	3388	3264
5616	5267	4951	4674	4426	4200	4021	3854	3699	3557	3428
5876	5513	5184	4894	4636	4400	4212	4038	3876	3727	3592
6136	5758	5416	5114	4846	4600	4404	4221	4052	3897	3755
6395	6003	5648	5335	5055	4800	4595	4405	4229	4067	3919
6653	6247	5879	5555	5265	5000	4787	4589	4405	4237	4083

Long Range Cruise Trip Fuel and Time
Reference Fuel and Time Required

AIR DIST (NM)	PRESSURE ALTITUDE (1000 FT)									
	29		31		33		35		37	
	FUEL (1000 KG)	TIME (HR:MIN)	FUEL (1000 KG)	TIME (HR:MIN)	FUEL (1000 KG)	TIME (HR:MIN)	FUEL (1000 KG)	TIME (HR:MIN)	FUEL (1000 KG)	TIME (HR:MIN)
200	1.4	0:38	1.4	0:37	1.4	0:37	1.4	0:36	1.4	0:36
400	2.4	1:08	2.4	1:07	2.4	1:06	2.3	1:05	2.3	1:04
600	3.4	1:39	3.4	1:37	3.3	1:34	3.3	1:33	3.2	1:31
800	4.5	2:09	4.4	2:06	4.3	2:03	4.2	2:00	4.1	1:59
1000	5.5	2:39	5.4	2:36	5.2	2:31	5.1	2:28	5.0	2:26
1200	6.5	3:09	6.4	3:04	6.2	2:59	6.1	2:56	6.0	2:53
1400	7.6	3:38	7.4	3:33	7.2	3:27	7.1	3:23	6.9	3:20
1600	8.7	4:07	8.4	4:01	8.2	3:55	8.0	3:50	7.8	3:47
1800	9.7	4:37	9.5	4:30	9.2	4:23	9.0	4:18	8.8	4:14
2000	10.8	5:06	10.5	4:58	10.2	4:51	9.9	4:45	9.7	4:41
2200	11.9	5:34	11.6	5:26	11.3	5:18	11.0	5:12	10.7	5:08
2400	13.0	6:03	12.7	5:53	12.3	5:45	12.0	5:39	11.7	5:34
2600	14.1	6:31	13.7	6:21	13.4	6:12	13.0	6:06	12.7	6:01
2800	15.3	6:59	14.8	6:49	14.4	6:39	14.0	6:33	13.7	6:28
3000	16.4	7:28	15.9	7:16	15.5	7:06	15.0	7:00	14.7	6:55
3200	17.5	7:55	17.0	7:43	16.6	7:33	16.1	7:26	15.8	7:21
3400	18.7	8:22	18.2	8:10	17.7	8:00	17.2	7:53	16.9	7:48
3600	19.9	8:50	19.3	8:37	18.8	8:27	18.2	8:20	18.0	8:14
3800	21.1	9:17	20.5	9:04	19.9	8:53	19.3	8:46	19.1	8:41
4000	22.2	9:44	21.6	9:31	21.0	9:20	20.4	9:13	20.1	9:07
4200	23.5	10:11	22.8	9:58	22.1	9:47	21.6	9:39	21.3	9:34
4400	24.7	10:38	24.0	10:24	23.3	10:13	22.7	10:06	22.5	10:00
4600	25.9	11:05	25.2	10:51	24.4	10:39	23.9	10:32	23.7	10:27
4800	27.2	11:31	26.4	11:17	25.6	11:06	25.0	10:59	24.9	10:53
5000	28.4	11:58	27.6	11:44	26.8	11:32	26.2	11:25	26.1	11:20

Fuel Required Adjustments (1000 KG)

REFERENCE FUEL REQUIRED (1000 KG)	LANDING WEIGHT (1000 KG)			
	30	40	50	60
5	-0.8	-0.4	0.0	0.7
10	-1.7	-0.9	0.0	1.5
15	-2.5	-1.3	0.0	2.5
20	-3.4	-1.8	0.0	3.7
25	-4.3	-2.3	0.0	5.1
30	-5.2	-2.7	0.0	6.6

Based on 280/.78 climb, Long Range Cruise and .78/280/250 descent.

**Long Range Cruise Step Climb
Ground to Air Miles Conversion**

AIR DISTANCE (NM)					GROUND DISTANCE (NM)	AIR DISTANCE (NM)				
HEADWIND COMPONENT (KTS)						TAILWIND COMPONENT (KTS)				
100	80	60	40	20		20	40	60	80	100
1325	1244	1173	1109	1052	1000	953	911	872	836	803
1843	1733	1636	1549	1471	1400	1336	1277	1224	1174	1129
2360	2222	2099	1989	1890	1800	1718	1644	1576	1513	1455
2876	2710	2561	2428	2309	2200	2101	2011	1928	1852	1781
3392	3197	3023	2868	2727	2600	2484	2378	2281	2191	2108
3907	3684	3485	3307	3146	3000	2867	2745	2633	2530	2435
4421	4170	3947	3746	3565	3400	3250	3113	2986	2870	2762
4934	4656	4408	4185	3983	3800	3633	3480	3339	3210	3090
5448	5142	4869	4624	4402	4200	4016	3847	3693	3550	3417
5961	5628	5330	5062	4820	4600	4399	4215	4046	3890	3745
6474	6113	5791	5501	5238	5000	4782	4583	4399	4230	4073

Trip Fuel and Time Required

AIR DIST (NM)	TRIP FUEL (1000 KG)				TIME (HR:MIN)
	LANDING WEIGHT (1000 KG)				
	30	40	50	60	
1000	3.7	4.3	5.0	5.7	2:27
1400	5.1	5.9	6.8	7.9	3:22
1800	6.5	7.5	8.7	10.1	4:16
2200	7.8	9.1	10.7	12.3	5:10
2600	9.3	10.8	12.6	14.7	6:04
3000	10.7	12.5	14.7	17.1	6:58
3400	12.2	14.2	16.8	19.5	7:51
3800	13.7	16.0	19.0	22.1	8:44
4200	15.3	17.9	21.2	24.7	9:37
4600	16.9	19.8	23.5	27.4	10:30
5000	18.5	21.8	25.9	30.1	11:23

Based on 280/.78 climb, Long Range Cruise, and .78/280/250 descent.

Valid for all pressure altitudes with 4000 ft step climb to 2000 ft above optimum altitude.

**Short Trip Fuel and Time
 Ground to Air Miles Conversion**

AIR DISTANCE (NM)					GROUND DISTANCE (NM)	AIR DISTANCE (NM)				
HEADWIND COMPONENT (KTS)						TAILWIND COMPONENT (KTS)				
100	80	60	40	20		20	40	60	80	100
92	79	69	61	55	50	46	42	39	37	34
157	141	128	117	108	100	93	87	82	77	73
222	203	186	172	160	150	141	133	125	119	113
287	264	244	228	213	200	189	178	169	161	153
351	325	302	283	265	250	236	224	213	203	194
415	385	360	337	318	300	284	270	257	246	235
478	446	417	392	370	350	332	316	301	288	276
542	506	475	447	422	400	380	362	346	331	317
607	568	533	502	475	450	428	408	389	373	357
673	629	591	557	527	500	476	453	433	415	398

Trip Fuel and Time Required

AIR DIST (NM)		LANDING WEIGHT (1000 KG)							TIME (HRS:MIN)
		30	35	40	45	50	55	60	
50	FUEL (1000 KG)	0.5	0.5	0.5	0.6	0.6	0.6	0.7	0:14
	ALT (FT)	11000	11000	11000	11000	9000	9000	9000	
100	FUEL (1000 KG)	0.7	0.8	0.8	0.9	0.9	1.0	1.0	0:22
	ALT (FT)	21000	21000	19000	19000	17000	17000	17000	
150	FUEL (1000 KG)	0.9	1.0	1.1	1.1	1.2	1.3	1.3	0:30
	ALT (FT)	29000	27000	27000	25000	25000	25000	23000	
200	FUEL (1000 KG)	1.1	1.2	1.3	1.4	1.5	1.5	1.6	0:37
	ALT (FT)	41000	35000	35000	29000	29000	27000	27000	
250	FUEL (1000 KG)	1.3	1.4	1.5	1.6	1.7	1.8	1.9	0:44
	ALT (FT)	41000	41000	41000	37000	35000	35000	31000	
300	FUEL (1000 KG)	1.4	1.6	1.7	1.8	1.9	2.0	2.1	0:50
	ALT (FT)	41000	41000	41000	39000	39000	37000	35000	
350	FUEL (1000 KG)	1.6	1.7	1.9	2.0	2.1	2.3	2.4	0:57
	ALT (FT)	41000	41000	41000	41000	39000	37000	35000	
400	FUEL (1000 KG)	1.8	1.9	2.1	2.2	2.3	2.5	2.7	1:04
	ALT (FT)	41000	41000	41000	41000	39000	37000	37000	
450	FUEL (1000 KG)	1.9	2.1	2.2	2.4	2.6	2.7	2.9	1:11
	ALT (FT)	41000	41000	41000	41000	41000	39000	37000	
500	FUEL (1000 KG)	2.1	2.3	2.4	2.6	2.8	3.0	3.2	1:18
	ALT (FT)	41000	41000	41000	41000	41000	39000	37000	

Based on 280/.78 climb, Long Range Cruise and .78/280/250 descent.

**Holding Planning
 Flaps Up**

WEIGHT (1000 KG)	TOTAL FUEL FLOW (KG/HR)								
	PRESSURE ALTITUDE (FT)								
	1500	5000	10000	15000	20000	25000	30000	35000	41000
70	2490	2450	2420	2400	2360	2330	2390	2470	
65	2330	2290	2260	2230	2200	2150	2210	2260	
60	2180	2130	2100	2070	2040	1980	2020	2060	2330
55	2020	1970	1940	1910	1870	1830	1840	1880	2030
50	1870	1820	1780	1750	1710	1680	1690	1710	1810
45	1720	1660	1650	1610	1580	1550	1530	1530	1610
40	1600	1550	1490	1450	1420	1400	1380	1360	1420
35	1450	1400	1350	1310	1280	1250	1230	1210	1240

This table includes 5% additional fuel for holding in a racetrack pattern.

Flight Crew Oxygen Requirements

Required Pressure (PSI) for 76 Cu. Ft. Cylinder

BOTTLE TEMPERATURE		NUMBER OF CREW USING OXYGEN		
°C	°F	2	3	4
50	122	735	1055	1360
45	113	725	1040	1340
40	104	715	1020	1320
35	95	700	1005	1300
30	86	690	990	1280
25	77	680	975	1255
20	68	670	960	1240
15	59	655	940	1215
10	50	645	925	1195
5	41	635	910	1175
0	32	620	890	1150
-5	23	610	875	1130
-10	14	600	860	1110

Required Pressure (PSI) for 114/115 Cu. Ft. Cylinder

BOTTLE TEMPERATURE		NUMBER OF CREW USING OXYGEN		
°C	°F	2	3	4
50	122	530	735	945
45	113	520	725	930
40	104	510	715	915
35	95	505	700	900
30	86	495	690	885
25	77	485	680	870
20	68	480	670	860
15	59	470	655	840
10	50	460	645	830
5	41	455	635	815
0	32	445	620	800
-5	23	440	610	785
-10	14	430	600	770

ENGINE INOP
MAX CONTINUOUS THRUST

Net Level Off Weight

PRESSURE ALTITUDE (1000 FT)	LEVEL OFF WEIGHT (1000 KG)		
	ISA + 10°C & BELOW	ISA + 15°C	ISA + 20°C
32	39.6		
30	43.4	42.2	40.7
28	47.2	45.8	44.3
26	51.3	49.7	48.2
24	54.7	53.0	51.3
22	57.2	55.3	53.3
20	59.7	57.3	54.5
18	61.2	58.2	54.9
16	61.8	58.6	55.7
14	64.0	61.0	58.1
12	66.5	63.3	60.2
10	69.3	65.8	62.7
8	72.2	68.8	65.5
6	72.5	71.6	68.2

Anti-Ice Adjustment

ANTI-ICE CONFIGURATION	LEVEL OFF WEIGHT ADJUSTMENT (1000 KG)									
	PRESSURE ALTITUDE (1000 FT)									
	12	14	16	18	20	22	24	26	28	30
ENGINE ONLY	-2.0	-1.8	-1.9	-1.9	-1.9	-1.5	-1.3	-1.2	-1.1	-1.0
ENGINE & WING	-7.5	-7.0	-7.0	-7.0	-6.7	-5.9	-4.9	-4.5	-4.3	-4.1

ALL ENGINES

Long Range Cruise Critical Fuel Reserves Ground to Air Miles Conversion

AIR DISTANCE (NM)					GROUND DISTANCE (NM)	AIR DISTANCE (NM)				
HEADWIND COMPONENT (KTS)						TAILWIND COMPONENT (KTS)				
100	80	60	40	20	20	40	60	80	100	
294	268	247	229	214	200	188	177	168	159	152
603	548	501	462	429	400	375	352	333	315	299
913	827	756	695	644	600	561	528	498	471	447
1224	1106	1010	929	860	800	748	703	662	626	594
1534	1386	1264	1162	1075	1000	935	878	827	782	742
1844	1665	1518	1395	1290	1200	1122	1053	992	938	889
2154	1945	1772	1628	1505	1400	1308	1228	1157	1094	1037
2465	2224	2027	1861	1721	1600	1495	1403	1322	1249	1184
2775	2504	2281	2094	1936	1800	1682	1578	1487	1405	1332

Critical Fuel (1000 KG)

AIR DIST (NM)	WEIGHT AT CRITICAL POINT (1000 KG)							
	35	40	45	50	55	60	65	70
200	1.7	1.7	1.8	1.8	1.9	2.0	2.0	2.1
300	2.4	2.4	2.5	2.6	2.7	2.8	2.9	3.0
400	3.1	3.1	3.2	3.4	3.5	3.6	3.7	3.8
500	3.8	3.8	4.0	4.1	4.3	4.4	4.5	4.7
600	4.5	4.5	4.7	4.9	5.0	5.2	5.4	5.6
700	5.2	5.2	5.4	5.6	5.8	6.0	6.2	6.4
800	5.9	5.9	6.1	6.4	6.6	6.8	7.0	7.2
900	6.6	6.6	6.8	7.1	7.3	7.6	7.8	8.1
1000	7.3	7.3	7.5	7.8	8.1	8.4	8.6	8.9
1100	8.0	8.0	8.2	8.5	8.8	9.2	9.4	9.7
1200	8.7	8.7	8.9	9.3	9.6	9.9	10.3	10.6
1300	9.4	9.4	9.6	10.0	10.4	10.7	11.1	11.4
1400	10.1	10.1	10.3	10.7	11.1	11.5	11.8	12.2
1500	10.8	10.8	11.0	11.4	11.8	12.2	12.6	13.0
1600	11.5	11.5	11.8	12.1	12.6	13.0	13.4	13.8
1700	12.2	12.2	12.5	12.8	13.3	13.7	14.2	14.6
1800	12.9	12.9	13.2	13.5	14.0	14.5	15.0	15.4

Based on: Emergency descent to 10000 ft. Level cruise at 10000 ft. 250 KIAS descent to 1500 ft. 15 minutes hold at 1500 ft. One missed approach; approach and land. 5% allowance for wind errors.

Increase fuel required 0.7% per 10°C above ISA conditions.

If icing conditions exist, increase fuel required by 18% to account for engine and wing anti-ice on (12%) and ice accumulation on unheated surfaces (6%).

Allowance for performance deterioration not included.

Compare the fuel required for all engine and engine inoperative critical fuel reserves and use the higher of the two.

ENGINE INOP

MAX CONTINUOUS THRUST

Long Range Cruise Critical Fuel Reserves Ground to Air Miles Conversion

AIR DISTANCE (NM)					GROUND DISTANCE (NM)	AIR DISTANCE (NM)				
HEADWIND COMPONENT (KTS)						TAILWIND COMPONENT (KTS)				
100	80	60	40	20		20	40	60	80	100
299	272	250	231	214	200	188	177	167	158	150
617	557	507	465	430	400	374	351	330	312	296
935	841	764	700	646	600	560	525	494	466	442
1253	1126	1022	935	862	800	746	699	657	620	587
1572	1411	1279	1170	1078	1000	932	873	821	775	733
1890	1695	1537	1405	1295	1200	1118	1047	984	929	879
2209	1980	1794	1640	1511	1400	1304	1221	1148	1083	1025
2527	2265	2052	1875	1727	1600	1491	1395	1311	1237	1171
2845	2549	2309	2110	1943	1800	1677	1569	1475	1391	1316

Critical Fuel (1000 KG)

AIR DIST (NM)	WEIGHT AT CRITICAL POINT (1000 KG)								
	35	40	45	50	55	60	65	70	
200	1.5	1.5	1.6	1.6	1.7	1.8	1.9	1.9	
300	2.1	2.1	2.2	2.3	2.4	2.5	2.6	2.7	
400	2.7	2.7	2.9	3.0	3.1	3.3	3.4	3.5	
500	3.3	3.3	3.5	3.7	3.8	4.0	4.2	4.3	
600	3.9	4.0	4.2	4.3	4.5	4.7	4.9	5.1	
700	4.5	4.6	4.8	5.0	5.3	5.5	5.7	5.9	
800	5.2	5.2	5.5	5.7	6.0	6.2	6.5	6.7	
900	5.8	5.8	6.1	6.4	6.6	6.9	7.2	7.5	
1000	6.4	6.4	6.7	7.0	7.3	7.6	7.9	8.3	
1100	7.0	7.0	7.3	7.7	8.0	8.3	8.7	9.0	
1200	7.6	7.7	7.9	8.3	8.7	9.0	9.4	9.8	
1300	8.2	8.3	8.6	8.9	9.3	9.7	10.1	10.6	
1400	8.9	8.9	9.2	9.6	10.0	10.5	10.9	11.3	
1500	9.5	9.5	9.8	10.2	10.7	11.1	11.6	12.1	
1600	10.1	10.1	10.4	10.9	11.3	11.8	12.3	12.8	
1700	10.7	10.8	11.0	11.5	12.0	12.5	13.0	13.5	
1800	11.3	11.4	11.6	12.1	12.6	13.2	13.7	14.3	

Based on: Emergency descent to 10000 ft. Level cruise at 10000 ft. 250 KIAS descent to 1500 ft. 15 minutes hold at 1500 ft. One missed approach; approach and land. 5% allowance for wind errors.

Increase fuel required 0.7% per 10°C above ISA conditions.

If icing conditions exist, increase fuel required by 15% to account for engine and wing anti-ice on (7%) and ice accumulation on unheated surfaces (8%).

Allowance for performance deterioration not included.

Compare the fuel required for all engine and engine inoperative critical fuel reserves and use the higher of the two.

Intentionally
Blank



Performance Dispatch
Landing

Chapter PD
Section 12

Landing Field Limit Weight - Dry Runway

Flaps 40

Based on anti-skid operative and automatic speedbrakes

Wind Corrected Field Length (M)

FIELD LENGTH AVAILABLE (M)	WIND COMPONENT (KTS)							
	-15	-10	-5	0	10	20	30	40
1000		800	900	1000	1070	1140	1200	1280
1200	900	990	1090	1200	1270	1350	1420	1500
1400	1070	1170	1280	1400	1480	1560	1640	1720
1600	1250	1360	1470	1600	1680	1770	1860	1950
1800	1430	1550	1660	1800	1890	1980	2080	2170
2000	1610	1730	1860	2000	2090	2180	2290	2390
2200	1780	1920	2050	2200	2290	2390	2510	2620
2400	1960	2110	2240	2400	2500	2600	2730	
2600	2140	2290	2430	2600	2700			
2800	2320	2480	2620	2800				

Field Limit Weight (1000 KG)

WIND CORR'D FIELD LENGTH (M)	AIRPORT PRESSURE ALTITUDE (FT)					
	0	2000	4000	6000	8000	10000
1000	36.8					
1200	47.5	44.6	42.0	39.4	36.9	
1400	57.4	54.8	51.7	48.6	45.6	42.7
1600	66.2	62.7	59.7	56.8	54.1	50.7
1800	72.5	70.8	67.4	63.6	60.5	57.5
2000		72.5	72.5	70.7	67.2	63.4
2200				72.5	72.5	69.7

Decrease field limit weight by 4450 kg when using manual speedbrakes.

Landing Field Limit Weight - Dry Runway

Flaps 40

Based on anti-skid inoperative and manual speedbrakes

Wind Corrected Field Length (M)

FIELD LENGTH AVAILABLE (M)	WIND COMPONENT (KTS)							
	-15	-10	-5	0	10	20	30	40
1800				1800	1940	2100	2260	2390
2000			1750	2000	2150	2310	2480	2620
2200		1720	1940	2200	2360	2520	2700	2850
2400	1680	1910	2140	2400	2560	2740	2920	3070
2600	1850	2090	2330	2600	2770	2950	3140	3300
2800	2030	2280	2520	2800	2980	3160	3350	3530
3000	2200	2460	2720	3000	3180	3370	3570	3760
3200	2380	2640	2910	3200	3390	3580	3790	3980
3400	2550	2830	3100	3400	3590	3800	4010	4210
3600	2730	3010	3290	3600	3800	4010	4230	4440
3800	2900	3200	3490	3800	4010	4220	4450	4660
4000	3080	3380	3680	4000	4210	4430	4670	4890
4200	3250	3560	3870	4200	4420	4640	4890	5120
4400	3430	3750	4070	4400	4630	4860	5110	5350
4600	3600	3930	4260	4600	4830	5070	5330	5570
4800	3780	4120	4450	4800	5040	5280	5540	5800
5000	3950	4300	4650	5000	5240	5490	5760	6030
5200	4130	4480	4840	5200	5450	5700	5980	6250
5400	4310	4670	5030	5400	5660	5920	6200	6480
5600	4480	4850	5230	5600	5860	6130	6420	6710

Field Limit Weight (1000 KG)

WIND CORR'D FIELD LENGTH (M)	AIRPORT PRESSURE ALTITUDE (FT)					
	0	2000	4000	6000	8000	10000
2000	37.7					
2200	42.9	40.3	37.3			
2400	48.1	45.2	42.0	39.2	36.5	
2600	53.4	50.2	46.7	43.6	40.6	37.8
2800	58.6	55.1	51.3	48.0	44.8	41.7
3000	63.8	60.0	55.9	52.3	48.9	45.5
3200	69.5	64.9	60.5	56.6	52.9	49.3
3400	72.5	70.1	65.1	60.8	56.8	53.0
3600		72.5	69.9	65.0	60.7	56.7
3800			72.5	69.6	64.7	60.3
4000				72.5	69.0	64.0
4200					72.5	68.1
4400						71.8
4600						72.5

Landing Field Limit Weight - Wet Runway

Flaps 40

Based on anti-skid operative and automatic speedbrakes

Wind Corrected Field Length (M)

FIELD LENGTH AVAILABLE (M)	WIND COMPONENT (KTS)							
	-15	-10	-5	0	10	20	30	40
1000				1000	1080	1150	1220	1300
1200		970	1080	1200	1280	1360	1440	1520
1400	1050	1150	1270	1400	1490	1570	1650	1750
1600	1230	1340	1460	1600	1690	1780	1870	1970
1800	1400	1530	1650	1800	1890	1990	2090	2190
2000	1580	1710	1850	2000	2100	2200	2310	2420
2200	1760	1900	2040	2200	2300	2410	2530	2640
2400	1940	2090	2230	2400	2510	2620	2750	2860
2600	2110	2270	2420	2600	2710	2830	2960	3090
2800	2290	2460	2610	2800	2910	3030	3180	
3000	2470	2650	2810	3000	3120			
3200	2650	2830	3000	3200				

Field Limit Weight (1000 KG)

WIND CORR'D FIELD LENGTH (M)	AIRPORT PRESSURE ALTITUDE (FT)					
	0	2000	4000	6000	8000	10000
1200	39.1	36.7				
1400	48.4	45.5	42.8	40.2	37.7	
1600	57.1	54.4	51.3	48.2	45.3	42.3
1800	64.5	61.3	58.5	55.6	52.6	49.3
2000	71.9	68.5	64.8	61.6	58.6	55.7
2200	72.5	72.5	71.4	67.9	64.1	60.8
2400			72.5	72.5	69.9	66.3
2600					72.5	71.5

Decrease field limit weight by 4450 kg when using manual speedbrakes.

737 Flight Crew Operations Manual

Landing Field Limit Weight - Wet Runway

Flaps 40

Based on anti-skid inoperative and manual speedbrakes

Wind Corrected Field Length (M)

FIELD LENGTH AVAILABLE (M)	WIND COMPONENT (KTS)							
	-15	-10	-5	0	10	20	30	40
1800					1960	2130	2300	2450
2000				2000	2160	2340	2520	2670
2200			1920	2200	2370	2550	2740	2900
2400		1860	2110	2400	2580	2760	2960	3130
2600		2050	2300	2600	2780	2980	3180	3350
2800	1960	2230	2500	2800	2990	3190	3400	3580
3000	2140	2410	2690	3000	3190	3400	3620	3810
3200	2310	2600	2880	3200	3400	3610	3840	4040
3400	2490	2780	3070	3400	3610	3820	4050	4260
3600	2660	2970	3270	3600	3810	4040	4270	4490
3800	2840	3150	3460	3800	4020	4250	4490	4720
4000	3010	3340	3650	4000	4230	4460	4710	4940
4200	3190	3520	3850	4200	4430	4670	4930	5170
4400	3370	3700	4040	4400	4640	4880	5150	5400
4600	3540	3890	4230	4600	4840	5100	5370	5630
4800	3720	4070	4430	4800	5050	5310	5590	5850
5000	3890	4260	4620	5000	5260	5520	5810	6080
5200	4070	4440	4810	5200	5460	5730	6030	6310
5400	4240	4620	5010	5400	5670	5940	6240	6530
5600	4420	4810	5200	5600	5880	6160	6460	6760

Field Limit Weight (1000 KG)

WIND CORR'D FIELD LENGTH (M)	AIRPORT PRESSURE ALTITUDE (FT)					
	0	2000	4000	6000	8000	10000
2400	40.0	37.5				
2600	44.5	41.8	38.7	36.1		
2800	49.0	46.1	42.8	39.9	37.2	
3000	53.6	50.4	46.9	43.8	40.8	37.9
3200	58.1	54.7	50.9	47.6	44.4	41.3
3400	62.6	58.9	54.9	51.4	48.0	44.7
3600	67.7	63.2	58.9	55.1	51.5	48.0
3800	72.0	67.8	62.8	58.8	54.9	51.2
4000	72.5	71.9	67.1	62.4	58.3	54.4
4200		72.5	71.1	66.3	61.7	57.6
4400			72.5	70.2	65.3	60.8
4600				72.5	69.0	64.0
4800					72.1	67.6
5000					72.5	70.8
5200						72.5

Landing Climb Limit Weight

Valid for approach with Flaps 15 and landing with Flaps 40

Based on engine bleed for packs on and anti-ice off

AIRPORT OAT (°C)	LANDING CLIMB LIMIT WEIGHT (1000 KG)						
	AIRPORT PRESSURE ALTITUDE (FT)						
	-2000	0	2000	4000	6000	8000	10000
54	50.9	48.6					
52	52.1	49.6					
50	53.2	50.7	49.9				
48	54.4	51.8	51.0				
46	55.4	52.8	52.0	51.1			
44	56.5	53.9	53.1	52.2			
42	57.6	55.0	54.2	53.2	49.2		
40	58.8	56.1	55.3	54.3	50.2		
38	59.9	57.3	56.5	55.4	51.1	45.5	
36	61.2	58.4	57.6	56.6	52.2	46.4	
34	62.4	59.5	58.7	57.7	53.2	47.3	41.3
32	62.5	60.7	59.9	58.8	54.2	48.2	42.1
30	62.5	62.0	61.1	59.9	55.2	49.2	42.9
28	62.6	62.0	61.4	60.3	56.2	50.2	43.9
26	62.6	62.1	61.4	60.3	57.2	51.2	44.8
24	62.7	62.2	61.5	60.4	57.6	52.1	45.7
22	62.7	62.2	61.5	60.4	57.6	53.1	46.6
20	62.8	62.3	61.6	60.4	57.6	54.0	47.5
18	62.8	62.3	61.6	60.5	57.6	54.8	48.4
16	62.9	62.3	61.6	60.5	57.7	55.0	49.3
14	62.9	62.4	61.7	60.5	57.7	55.0	50.3
12	63.0	62.4	61.7	60.6	57.7	55.0	51.3
10	63.0	62.5	61.8	60.6	57.8	55.1	52.2
-40	63.5	62.9	62.2	61.0	58.2	55.5	52.6

With engine bleed for packs off, increase weight by 1150 kg.

With engine anti-ice on, decrease weight by 200 kg.

With engine and wing anti-ice on, decrease weight by 750 kg.

When operating in icing conditions during any part of the flight with forecast landing temperature below 10°C, decrease weight by 4100 kg.

ENGINE INOP

Go-Around Climb Gradient

Flaps 15

Based on engine bleed for packs on and anti-ice off

OAT (°C)	REFERENCE GO-AROUND GRADIENT (%)					
	PRESSURE ALTITUDE (FT)					
	0	2000	4000	6000	8000	10000
54	1.41					
50	1.92	1.74				
46	2.44	2.24	2.03			
42	2.98	2.78	2.52	1.58		
38	3.53	3.33	3.08	2.02	0.69	
34	4.09	3.88	3.63	2.53	1.11	
30	4.69	4.48	4.17	3.02	1.58	0.09
26	4.72	4.55	4.28	3.51	2.05	0.53
22	4.74	4.58	4.30	3.60	2.50	0.96
18	4.76	4.60	4.31	3.61	2.94	1.39
14	4.79	4.62	4.33	3.63	2.97	1.85
10	4.81	4.63	4.35	3.65	2.99	2.31

Gradient Adjustment for Weight (%)

WEIGHT (1000 KG)	REFERENCE GO-AROUND GRADIENT (%)					
	0	1	2	3	4	5
65	-2.27	-2.60	-2.86	-3.11	-3.36	-3.61
60	-1.65	-1.88	-2.07	-2.26	-2.43	-2.62
55	-0.91	-1.04	-1.14	-1.24	-1.34	-1.44
50	0.00	0.00	0.00	0.00	0.00	0.00
45	1.12	1.24	1.36	1.49	1.63	1.76
40	2.56	2.83	3.10	3.39	3.69	3.98

Gradient Adjustment for Speed (%)

SPEED (KIAS)	WEIGHT ADJUSTED GO-AROUND GRADIENT (%)									
	0	1	2	3	4	5	6	7	8	9
VREF40	-0.34	-0.35	-0.36	-0.37	-0.37	-0.37	-0.36	-0.36	-0.36	-0.35
VREF40+5	0.00	0.00	0.00	0.00	0.00	0.00	0.00	0.00	0.00	0.00
VREF40+10	0.17	0.18	0.19	0.19	0.19	0.19	0.18	0.19	0.19	0.18
VREF40+20	0.33	0.32	0.31	0.28	0.26	0.24	0.22	0.21	0.21	0.20
VREF40+30	0.22	0.15	0.07	0.00	-0.04	-0.06	-0.07	-0.09	-0.12	-0.14

With engine bleed for packs off, increase gradient by 0.3%.

With engine anti-ice on, decrease gradient by 0.1%.

With engine and wing anti-ice on, decrease gradient by 0.2%.

When operating in icing conditions during any part of the flight with forecast landing temperatures below 10°C, decrease gradient by 0.6%.

Quick Turnaround Limit Weight Flaps 40

OAT (°C)	AIRPORT PRESSURE ALTITUDE (FT)					
	0	2000	4000	6000	8000	10000
54	71.8					
50	72.2	69.5				
45	72.5	70.0	67.4			
40	72.5	70.6	67.9	65.0		
35	72.5	71.2	68.5	65.8	62.9	
30	72.5	71.8	69.0	66.3	63.4	60.8
25	72.5	72.4	69.6	66.9	63.9	61.3
20	72.5	72.5	70.2	67.4	64.5	61.8
15	72.5	72.5	70.8	68.0	65.1	62.4
10	72.5	72.5	71.4	68.6	65.9	62.9
5	72.5	72.5	72.1	69.2	66.5	63.5
0	72.5	72.5	72.5	69.9	67.1	64.1
-5	72.5	72.5	72.5	70.5	67.7	64.7
-10	72.5	72.5	72.5	71.2	68.4	65.4
-15	72.5	72.5	72.5	71.9	69.0	66.2
-20	72.5	72.5	72.5	72.5	69.7	66.8
-30	72.5	72.5	72.5	72.5	71.1	68.2
-40	72.5	72.5	72.5	72.5	72.5	69.6
-50	72.5	72.5	72.5	72.5	72.5	71.2
-54	72.5	72.5	72.5	72.5	72.5	71.8

Increase weight by 650 kg per 1% uphill slope. Decrease weight by 950 kg per 1% downhill slope.
 Increase weight by 1800 kg per 10 knots headwind. Decrease weight by 6350 kg per 10 knots tailwind.

After landing at weights exceeding those shown above, adjusted for slope and wind, wait at least 62 minutes and check that wheel thermal plugs have not melted before executing a subsequent takeoff.

As an alternate procedure, ensure that each brake pressure plate surface temperature, without artificial cooling, is less than 218°C as follows: No sooner than 10 and no later than 15 minutes after parking, measure each brake pressure plate surface temperature at a minimum of two points per brake by an accurate method (using a Doric Microtemp 450 hand held thermometer or equivalent, hold temperature probe in place for 20 seconds or until reading stabilizes). If each measured temperature is less than 218°C, immediate dispatch is allowed; otherwise the required minimum ground wait period of 62 minutes applies.

If a Brake Temperature Monitoring System (BTMS) is installed:

No sooner than 10 and no later than 15 minutes after parking, check the BRAKE TEMP light. If the BRAKE TEMP light is not on, no ground waiting period is required. If the BRAKE TEMP light is on, do not dispatch until at least 62 minutes after landing, or until all the BTMS readings on the systems Display are below 3.5 and the BRAKE TEMP light is off. Check that wheel thermal plugs have not melted before making a subsequent takeoff.

Note: If any brake temperature display digit is blank or indicates 0.0 or 0.1, then this method cannot be used.

Intentionally
Blank

Performance Dispatch

Chapter PD

Text

Section 13

Introduction

This chapter contains self dispatch performance data intended primarily for use by flight crews in the event that information cannot be obtained from the airline dispatch office. The takeoff data provided is for a single takeoff flap at max takeoff thrust. The range of conditions covered is limited to those normally encountered in airline operation. In the event of conflict between the data presented in this chapter and that contained in the approved Airplane Flight Manual, the Flight Manual shall always take precedence.

Takeoff

The maximum allowable takeoff weight will be the least of the Field, Climb and Obstacle Limit Weights as determined from the tables shown. Tire and Brake Energy Limits are not shown as they are not limiting for the range of conditions shown in this chapter.

JAROPS-1 requires that the runway length be adjusted to account for alignment of the airplane prior to takeoff. The table below provides TORA, TODA and ASDA adjustments for both 90 degree taxiway entry and 180 degree turnaround. For the 180 degree turnaround case, adjustments are provided for both a nominal 60 m runway as well as the minimum required for the stated minimum pavement width. These values may be used when obtaining takeoff weights from the Airplane Flight Manual or a takeoff analysis program. When using line-up allowances with the Field Length Limit chart, the field length available must be reduced by the ASDA adjustment.

	90 DEGREE TAXIWAY ENTRY	180 DEGREE TURNAROUND	
	MINIMUM LINE-UP DISTANCE (M)	NOMINAL LINE-UP DISTANCE (M) (60.0 M RUNWAY)	MINIMUM LINE-UP DISTANCE (M) (24.4 M RUNWAY)
TORA & TODA	9.6	15.0	15.0
ASDA	20.9	26.4	26.4

Field Limit Weight - Slope and Wind Corrections

These tables for dry and wet runways provide corrections to the field length available for the effects of runway slope and wind component along the runway. Enter the appropriate table with the available field length and runway slope to determine the slope corrected field length. Next enter the appropriate table with slope corrected field length and wind component to determine the slope and wind corrected field length.

Field and Climb Limit Weight

Tables are presented for selected airport pressure altitudes and runway conditions and show both Field and Climb Limit Weights. Enter the appropriate table for pressure altitude and runway condition with “Slope and Wind Corrected Field Length” determined above and airport OAT to obtain Field Limit Weight. Also read Climb Limit Weight for the same OAT. Intermediate altitudes may be interpolated or use next higher altitude. When finding a maximum weight for a wet runway, the dry runway limit weight must also be determined and the lower of the two weights used.

Obstacle Limit Weight

The Reference Obstacle Limit Weight table provides obstacle limit weights for reference airport conditions based on obstacle height above the runway surface and distance from brake release. Enter the adjustment tables to adjust the reference Obstacle Limit Weight for the effects of OAT, pressure altitude and wind as indicated. In the case of multiple obstacles, enter the tables successively with each obstacle and determine the most limiting weight.

When using line-up allowances with the Obstacle Limit chart, the obstacle distance from brake release must be reduced by the ASDA adjustment.

Enroute

Long Range Cruise Maximum Operating Altitude

These tables provide the maximum operating altitude in the same manner as the FMC. Maximum altitudes are shown for a given cruise weight and maneuver capability. Note that this table considers both thrust and buffet limits, providing the more limiting of the two. Any data that is thrust limited is denoted by an asterisk and represents only a thrust limited condition in level flight with 100 ft/min residual rate of climb. Flying above these altitudes with sustained banks in excess of approximately 15° may cause the airplane to lose speed and/or altitude. The altitudes shown in the table are limited to the maximum certified altitude of 41000 ft.

Long Range Cruise Trip Fuel and Time

Long Range Cruise Trip Fuel and Time tables are provided to determine trip time and fuel required to destination.

To determine trip fuel and time for a constant altitude cruise, first enter the Ground to Air Miles Conversion table to convert ground distance and enroute wind to an equivalent still air distance for use with the Reference Fuel and Time tables. Next, enter the Reference Fuel and Time table with

air distance from the Ground to Air Miles Conversion table and the desired altitude and read Reference Fuel and Time Required. Lastly, enter the Fuel Required Adjustment table with the Reference Fuel and the planned landing weight to obtain the adjustment to the fuel required at the planned landing weight.

Long Range Cruise Step Climb Trip Fuel and Time

The Long Range Cruise Step Climb Trip Fuel and Time tables are provided to determine trip time and fuel required to destination when flying a step climb profile. Step climb profiles are based on 4000 ft step climbs to keep the flight within 2000 ft of the optimum altitude for the current cruise weight. To determine trip fuel and time, enter the Ground to Air Miles Conversion table and determine air distance as discussed above. Then enter the Trip Fuel and Time Required table with air distance and planned landing weight to read trip fuel. Continue across the table to read trip time.

Short Trip Fuel and Time

These tables are provided to determine trip fuel and time for short distances or alternates. Obtain air distance from the table using the ground distance and wind component to the alternate. Enter the Trip Fuel and Time Required table with air distance and read trip fuel required for the expected landing weight, together with time to alternate at right. For distances greater than shown or other altitudes, use the Long Range Cruise Trip Fuel and Time tables.

Holding Planning

This table provides total fuel flow information necessary for planning flaps up holding and reserve fuel requirements. Data is based on the FMC holding speed schedule which is the higher of the maximum endurance and flaps up maneuver speeds. As noted, the fuel flow is based on flight in a racetrack holding pattern. For holding in straight and level flight, reduce table values by 5%.

Flight Crew Oxygen Requirements

Regulations require that sufficient oxygen be provided to the flight crew to account for the greater of supplemental breathing oxygen in the event of a cabin depressurization or protective breathing in the event of smoke or harmful fumes in the flight deck. The oxygen quantity associated with the above requirements is achieved with the minimum dispatch oxygen cylinder pressure.

To determine the minimum dispatch oxygen cylinder pressure enter the appropriate flight crew oxygen table with the number of crew plus observers using oxygen and read the minimum cylinder pressure required for the appropriate cylinder temperature.

Net Level Off Weight

The Net Level Off Weight table is provided to determine terrain clearance capability in straight and level flight following an engine failure. Regulations require terrain clearance planning based on net performance which is the gross (or actual) gradient performance degraded by 1.1%. In addition, the net level off pressure altitude must clear the terrain by 1000 ft.

To determine the maximum weight for terrain clearance, enter the table with required net level off pressure altitude and expected ISA deviation to obtain weight. Adjust weight for anti-ice operation as noted below the table.

Extended Range Operations

Regulations require that flights conducted over a route that contains a point further than one hour's time at "normal one engine inoperative speed" from an adequate diversion airport comply with rules set up specifically for "Extended Range Operation with Two Engine airplanes." This section provides reserve fuel planning information for the "Critical Fuel Scenario" based on two engine operation at Long Range Cruise as well as single engine operation at Long Range Cruise.

Long Range Cruise Critical Fuel Reserves

Enter the Ground to Air Miles Conversion table with forecast wind and ground distance to diversion airport from critical point to obtain air distance. Now enter the Critical Fuel table with air distance and expected weight at the critical point and read required fuel. Apply the noted fuel adjustments as necessary. Regulations require a 5% allowance for performance deterioration unless a value has been established by the operator for inservice deterioration.

As noted below each table, the fuel required is the greater of the two engine fuel and the single engine fuel. This fuel is compared to the amount of fuel normally onboard the airplane at that point in the route. If the fuel required by the critical fuel reserves exceeds the amount of fuel normally expected, the fuel load must be adjusted accordingly.

Landing

Tables are provided for determining the maximum landing weight as limited by field length or climb requirements for a single landing flap.

Maximum landing weight is the lowest of the field length limit weight, climb limit weight, or maximum certified landing weight.

Landing Field Limit Weight

For the expected runway condition and anti-skid system configuration, obtain wind corrected field length by entering the Wind Corrected Field Length table with field length available and wind component along the runway. Now enter the Field Limit Weight table with wind corrected field length and pressure altitude to read field limit weight.

Landing Climb Limit Weight

Enter the table with airport OAT and pressure altitude to read landing climb limit weight. Apply the noted adjustments as required.

Go-Around Climb Gradient

Enter the Reference Go-Around Gradient table with airport OAT and pressure altitude to determine the reference go-around gradient. Then adjust the reference gradient for airplane weight and speed using the tables provided to determine the weight and speed adjusted go-around gradient. Apply the necessary corrections for engine bleed configuration and icing conditions as noted.

Quick Turnaround Limit Weight

Enter the table with airport pressure altitude and OAT to read maximum quick turnaround weight. Apply the noted adjustments as required.

If the landing weight exceeds the maximum quick turnaround weight, wait the specified time and then check that the wheel thermal plugs have not melted before executing a subsequent takeoff, or ensure the brake temperature is within limits using the alternate procedure described on the page.

Intentionally
Blank

Performance Dispatch

Chapter PD

Takeoff

Section 20

Takeoff Field Corrections - Dry Runway

Slope Corrections

FIELD LENGTH AVAILABLE (M)	SLOPE CORRECTED FIELD LENGTH (M)								
	RUNWAY SLOPE (%)								
	-2.0	-1.5	-1.0	-0.5	0.0	0.5	1.0	1.5	2.0
1200	1210	1210	1210	1200	1200	1170	1140	1110	1080
1400	1450	1440	1420	1410	1400	1360	1310	1270	1220
1600	1680	1660	1640	1620	1600	1540	1480	1420	1360
1800	1920	1890	1860	1830	1800	1730	1650	1580	1510
2000	2150	2110	2080	2040	2000	1910	1820	1740	1650
2200	2390	2340	2290	2250	2200	2100	2000	1890	1790
2400	2620	2570	2510	2460	2400	2280	2170	2050	1930
2600	2860	2790	2730	2660	2600	2470	2340	2210	2080
2800	3090	3020	2950	2870	2800	2650	2510	2360	2220
3000	3330	3250	3160	3080	3000	2840	2680	2520	2360
3200	3570	3480	3380	3290	3200	3030	2850	2680	2500
3400	3810	3710	3610	3500	3400	3210	3020	2830	2650
3600	4060	3940	3830	3710	3600	3400	3190	2990	2790
3800	4300	4180	4050	3930	3800	3580	3370	3150	2930
4000	4550	4410	4270	4140	4000	3770	3540	3300	3070
4200	4790	4650	4500	4350	4200	3950	3710	3460	3210
4400	5040	4880	4720	4560	4400	4140	3880	3620	3360
4600	5280	5110	4940	4770	4600	4320	4050	3770	3500
4800	5530	5350	5160	4980	4800	4510	4220	3930	3640
5000	5770	5580	5390	5190	5000	4700	4390	4090	3780

Wind Corrections

SLOPE CORR'D FIELD LENGTH (M)	SLOPE & WIND CORRECTED FIELD LENGTH (M)							
	WIND COMPONENT (KTS)							
	-15	-10	-5	0	10	20	30	40
1200	860	970	1090	1200	1280	1350	1430	1500
1400	1030	1150	1280	1400	1480	1560	1640	1720
1600	1200	1340	1470	1600	1680	1770	1850	1940
1800	1370	1520	1660	1800	1890	1980	2060	2150
2000	1550	1700	1850	2000	2090	2180	2280	2370
2200	1720	1880	2040	2200	2300	2390	2490	2590
2400	1890	2060	2230	2400	2500	2600	2700	2800
2600	2060	2240	2420	2600	2700	2810	2910	3020
2800	2230	2420	2610	2800	2910	3020	3130	3240
3000	2400	2600	2800	3000	3110	3230	3340	3450
3200	2570	2780	2990	3200	3320	3430	3550	3670
3400	2740	2960	3180	3400	3520	3640	3760	3890
3600	2910	3140	3370	3600	3730	3850	3980	4100
3800	3080	3320	3560	3800	3930	4060	4190	4320
4000	3260	3500	3750	4000	4130	4270	4400	4540
4200	3430	3680	3940	4200	4340	4480	4610	4750
4400	3600	3870	4130	4400	4540	4680	4830	4970
4600	3770	4050	4320	4600	4750	4890	5040	5190
4800	3940	4230	4510	4800	4950	5100	5250	5400
5000	4110	4410	4700	5000	5150	5310	5460	5620

737 Flight Crew Operations Manual

Takeoff Field & Climb Limit Weights - Dry Runway

Flaps 5

Sea Level Pressure Altitude

CORR'D FIELD LENGTH (M)	FIELD LIMIT WEIGHT (1000 KG)										
	OAT										
	°C -40	14	18	22	24	26	28	30	42	46	50
°F -40	57	64	72	75	79	82	86	108	115	122	
1220	54.1	50.3	50.0	49.7	49.5	49.4	49.2	49.1	44.6	43.1	41.8
1400	58.0	53.9	53.6	53.3	53.1	53.0	52.8	52.6	47.9	46.4	45.0
1600	61.9	57.7	57.3	57.0	56.8	56.7	56.5	56.3	51.3	49.7	48.2
1800	65.6	61.1	60.8	60.4	60.2	60.0	59.9	59.7	54.4	52.7	51.1
2000	69.1	64.3	63.9	63.6	63.4	63.2	63.0	62.8	57.2	55.4	53.7
2200	72.3	67.3	66.9	66.5	66.3	66.1	65.9	65.7	59.8	57.9	56.2
2400	75.4	70.1	69.7	69.3	69.1	68.9	68.7	68.5	62.3	60.3	58.5
2600	78.4	72.9	72.5	72.0	71.8	71.6	71.4	71.1	64.7	62.6	60.7
2800	81.3	75.6	75.1	74.7	74.4	74.2	74.0	73.7	67.0	64.9	62.8
3000	81.6	78.1	77.6	77.2	76.9	76.7	76.5	76.2	69.3	67.1	65.1
3200	81.6	80.3	79.8	79.3	79.1	78.9	78.6	78.4	71.2	69.0	66.8
3400	81.6	81.6	81.6	81.4	81.2	80.9	80.7	80.4	73.0	70.7	68.5
3600	81.6	81.6	81.6	81.6	81.6	81.6	81.6	81.6	74.8	72.4	70.1
3800	81.6	81.6	81.6	81.6	81.6	81.6	81.6	81.6	76.5	74.0	71.6
4000	81.6	81.6	81.6	81.6	81.6	81.6	81.6	81.6	78.1	75.6	73.2
4200	81.6	81.6	81.6	81.6	81.6	81.6	81.6	81.6	79.8	77.1	74.7
4400	81.6	81.6	81.6	81.6	81.6	81.6	81.6	81.6	81.5	78.7	76.2
4600	81.6	81.6	81.6	81.6	81.6	81.6	81.6	81.6	81.6	80.3	77.7
CLIMB LIMIT WT (1000 KG)	63.0	62.5	62.4	62.3	62.3	62.2	62.2	62.1	55.0	52.8	50.7

1000 FT Pressure Altitude

CORR'D FIELD LENGTH (M)	FIELD LIMIT WEIGHT (1000 KG)										
	OAT										
	°C -40	14	18	22	24	26	28	30	42	46	50
°F -40	57	64	72	75	79	82	86	108	115	122	
1220	53.3	49.4	49.1	48.8	48.6	48.5	48.3	48.1	43.9	42.4	41.1
1400	57.1	53.0	52.6	52.3	52.2	52.0	51.8	51.6	47.2	45.7	44.3
1600	61.0	56.6	56.3	56.0	55.8	55.6	55.5	55.2	50.5	48.9	47.4
1800	64.6	60.0	59.7	59.3	59.1	59.0	58.8	58.6	53.6	51.9	50.3
2000	68.0	63.2	62.8	62.4	62.2	62.0	61.8	61.6	56.3	54.6	52.9
2200	71.2	66.1	65.7	65.3	65.1	64.9	64.7	64.5	58.9	57.0	55.3
2400	74.2	68.9	68.5	68.0	67.8	67.6	67.4	67.2	61.3	59.4	57.5
2600	77.2	71.6	71.1	70.7	70.5	70.3	70.1	69.8	63.7	61.6	59.7
2800	80.0	74.2	73.7	73.3	73.0	72.8	72.6	72.3	65.9	63.8	61.8
3000	81.6	76.7	76.2	75.7	75.5	75.3	75.1	74.8	68.2	66.1	64.0
3200	81.6	78.8	78.3	77.9	77.6	77.4	77.2	76.9	70.1	67.9	65.7
3400	81.6	80.9	80.4	79.9	79.6	79.4	79.2	78.8	71.9	69.6	67.4
3600	81.6	81.6	81.6	81.6	81.6	81.4	81.1	80.8	73.6	71.2	68.9
3800	81.6	81.6	81.6	81.6	81.6	81.6	81.6	81.6	75.2	72.8	70.4
4000	81.6	81.6	81.6	81.6	81.6	81.6	81.6	81.6	76.9	74.3	71.9
4200	81.6	81.6	81.6	81.6	81.6	81.6	81.6	81.6	78.5	75.9	73.4
4400	81.6	81.6	81.6	81.6	81.6	81.6	81.6	81.6	80.1	77.4	74.9
4600	81.6	81.6	81.6	81.6	81.6	81.6	81.6	81.6	81.6	79.0	76.3
CLIMB LIMIT WT (1000 KG)	62.7	62.1	62.1	62.0	61.9	61.9	61.8	61.7	54.8	52.5	50.4

Takeoff Field & Climb Limit Weights - Dry Runway

Flaps 5

2000 FT Pressure Altitude

CORR'D FIELD LENGTH (M)	FIELD LIMIT WEIGHT (1000 KG)										
	OAT										
	°C -40	14	18	22	24	26	28	30	42	46	50
°F -40	57	64	72	75	79	82	86	108	115	122	
1220	52.5	48.5	48.2	47.9	47.8	47.6	47.5	47.2	43.0	41.7	40.4
1400	56.2	52.0	51.7	51.4	51.3	51.1	51.0	50.7	46.3	44.9	43.5
1600	60.1	55.7	55.3	55.0	54.8	54.7	54.5	54.3	49.6	48.1	46.7
1800	63.7	59.0	58.6	58.3	58.1	58.0	57.8	57.5	52.6	51.0	49.5
2000	67.0	62.1	61.7	61.3	61.2	61.0	60.8	60.5	55.3	53.6	52.0
2200	70.2	64.9	64.6	64.2	64.0	63.8	63.6	63.3	57.8	56.0	54.3
2400	73.1	67.7	67.3	66.9	66.7	66.5	66.3	65.9	60.2	58.3	56.6
2600	76.0	70.3	69.9	69.5	69.3	69.0	68.8	68.5	62.5	60.5	58.7
2800	78.8	72.9	72.4	72.0	71.8	71.5	71.3	71.0	64.7	62.7	60.7
3000	81.4	75.3	74.9	74.4	74.2	74.0	73.8	73.4	67.0	64.9	62.9
3200	81.6	77.4	77.0	76.5	76.3	76.1	75.8	75.5	68.8	66.6	64.6
3400	81.6	79.5	79.0	78.5	78.3	78.0	77.8	77.4	70.5	68.3	66.2
3600	81.6	81.4	80.9	80.4	80.2	79.9	79.7	79.3	72.2	69.9	67.7
3800	81.6	81.6	81.6	81.6	81.6	81.6	81.5	81.1	73.8	71.4	69.2
4000	81.6	81.6	81.6	81.6	81.6	81.6	81.6	81.6	75.4	72.9	70.6
4200	81.6	81.6	81.6	81.6	81.6	81.6	81.6	81.6	77.0	74.4	72.1
4400	81.6	81.6	81.6	81.6	81.6	81.6	81.6	81.6	78.5	75.9	73.5
4600	81.6	81.6	81.6	81.6	81.6	81.6	81.6	81.6	80.1	77.4	74.9
CLIMB LIMIT WT (1000 KG)	62.4	61.9	61.8	61.8	61.7	61.7	61.6	61.4	54.3	52.0	49.9

3000 FT Pressure Altitude

CORR'D FIELD LENGTH (M)	FIELD LIMIT WEIGHT (1000 KG)										
	OAT										
	°C -40	14	18	22	24	26	28	30	42	46	50
°F -40	57	64	72	75	79	82	86	108	115	122	
1220	51.5	47.5	47.2	46.9	46.8	46.6	46.5	46.2	42.2	40.9	39.7
1400	55.2	51.0	50.7	50.4	50.2	50.1	49.9	49.6	45.5	44.1	42.8
1600	59.0	54.5	54.2	53.9	53.7	53.6	53.4	53.1	48.7	47.3	45.9
1800	62.5	57.8	57.5	57.1	57.0	56.8	56.6	56.3	51.7	50.1	48.7
2000	65.8	60.8	60.4	60.1	59.9	59.7	59.6	59.2	54.3	52.7	51.2
2200	68.9	63.6	63.2	62.9	62.7	62.5	62.3	62.0	56.8	55.1	53.5
2400	71.8	66.3	65.9	65.5	65.3	65.1	64.9	64.6	59.1	57.3	55.7
2600	74.6	68.8	68.4	68.0	67.8	67.6	67.4	67.0	61.3	59.5	57.7
2800	77.3	71.3	70.9	70.5	70.3	70.1	69.8	69.5	63.5	61.6	59.8
3000	79.9	73.8	73.3	72.9	72.7	72.5	72.2	71.8	65.8	63.8	61.9
3200	81.6	75.8	75.4	74.9	74.7	74.5	74.3	73.8	67.6	65.5	63.6
3400	81.6	77.8	77.3	76.8	76.6	76.4	76.2	75.7	69.2	67.1	65.1
3600	81.6	79.7	79.2	78.7	78.5	78.3	78.0	77.6	70.9	68.7	66.6
3800	81.6	81.5	81.0	80.5	80.3	80.0	79.8	79.3	72.4	70.2	68.1
4000	81.6	81.6	81.6	81.6	81.6	81.6	81.6	81.1	74.0	71.6	69.5
4200	81.6	81.6	81.6	81.6	81.6	81.6	81.6	81.6	75.5	73.1	70.9
4400	81.6	81.6	81.6	81.6	81.6	81.6	81.6	81.6	77.0	74.6	72.3
4600	81.6	81.6	81.6	81.6	81.6	81.6	81.6	81.6	78.6	76.0	73.7
CLIMB LIMIT WT (1000 KG)	61.8	61.4	61.3	61.2	61.2	61.1	61.1	60.7	53.8	51.6	49.6

Takeoff Field Corrections - Wet Runway

Slope Corrections

FIELD LENGTH AVAILABLE (M)	SLOPE CORRECTED FIELD LENGTH (M)								
	RUNWAY SLOPE (%)								
	-2.0	-1.5	-1.0	-0.5	0.0	0.5	1.0	1.5	2.0
1200	1210	1210	1210	1200	1200	1180	1160	1130	1110
1400	1440	1430	1420	1410	1400	1370	1330	1300	1270
1600	1680	1660	1640	1620	1600	1550	1510	1460	1420
1800	1910	1880	1850	1830	1800	1740	1690	1630	1570
2000	2140	2100	2070	2030	2000	1930	1860	1790	1730
2200	2370	2330	2290	2240	2200	2120	2040	1960	1880
2400	2600	2550	2500	2450	2400	2300	2210	2110	2020
2600	2830	2780	2720	2660	2600	2490	2380	2270	2160
2800	3070	3000	2930	2870	2800	2670	2550	2420	2300
3000	3300	3220	3150	3070	3000	2860	2720	2580	2440
3200	3540	3460	3370	3290	3200	3040	2890	2730	2580
3400	3790	3690	3600	3500	3400	3230	3060	2890	2720
3600	4040	3930	3820	3710	3600	3410	3230	3040	2860
3800	4290	4170	4050	3920	3800	3600	3400	3200	3000
4000	4540	4410	4270	4140	4000	3780	3570	3350	3140
4200	4790	4640	4500	4350	4200	3970	3740	3510	3280
4400	5040	4880	4720	4560	4400	4150	3900	3650	3400
4600	5290	5120	4950	4770	4600	4330	4050	3780	3510
4800	5540	5360	5170	4990	4800	4500	4210	3910	3620
5000	5790	5590	5400	5200	5000	4680	4360	4040	3730

Wind Corrections

SLOPE CORR'D FIELD LENGTH (M)	SLOPE & WIND CORRECTED FIELD LENGTH (M)							
	WIND COMPONENT (KTS)							
	-15	-10	-5	0	10	20	30	40
1200	830	960	1080	1200	1280	1370	1460	1550
1400	1000	1130	1270	1400	1490	1580	1680	1770
1600	1170	1310	1460	1600	1700	1790	1890	2000
1800	1340	1490	1650	1800	1900	2000	2110	2220
2000	1500	1670	1830	2000	2110	2220	2330	2440
2200	1670	1850	2020	2200	2310	2430	2550	2670
2400	1840	2030	2210	2400	2520	2640	2760	2890
2600	2010	2200	2400	2600	2720	2850	2980	3110
2800	2170	2380	2590	2800	2930	3060	3200	3340
3000	2340	2560	2780	3000	3130	3270	3410	3560
3200	2510	2740	2970	3200	3340	3480	3630	3780
3400	2680	2920	3160	3400	3540	3690	3850	4010
3600	2850	3100	3350	3600	3750	3900	4060	4230
3800	3010	3280	3540	3800	3950	4120	4280	4450
4000	3180	3450	3730	4000	4160	4330	4500	4680
4200	3350	3630	3920	4200	4370	4540	4720	4900
4400	3520	3810	4110	4400	4570	4750	4930	5120
4600	3680	3990	4290	4600	4780	4960	5150	5350
4800	3850	4170	4480	4800	4980	5170	5370	5570
5000	4020	4350	4670	5000	5190	5380	5580	5790

**Takeoff Field & Climb Limit Weights - Wet Runway
 Flaps 5**

Sea Level Pressure Altitude

CORR'D FIELD LENGTH (M)	FIELD LIMIT WEIGHT (1000 KG)										
	OAT										
	°C -40	14	18	22	24	26	28	30	42	46	50
°F -40	57	64	72	75	79	82	86	108	115	122	
1310	56.6	51.6	51.2	50.9	50.7	50.5	50.3	50.2	46.2	44.9	43.8
1400	58.6	53.4	53.0	52.6	52.4	52.3	52.1	51.9	47.7	46.4	45.2
1600	62.6	57.0	56.6	56.2	56.0	55.8	55.6	55.4	51.0	49.6	48.3
1800	66.3	60.4	60.0	59.5	59.3	59.1	58.9	58.7	54.0	52.5	51.1
2000	69.7	63.4	63.0	62.5	62.3	62.1	61.9	61.7	56.7	55.1	53.7
2200	72.9	66.4	65.9	65.4	65.2	65.0	64.7	64.5	59.3	57.6	56.1
2400	76.1	69.2	68.7	68.2	68.0	67.7	67.5	67.2	61.8	60.1	58.5
2600	79.1	71.9	71.4	70.9	70.6	70.4	70.1	69.9	64.2	62.4	60.7
2800	81.6	74.5	74.0	73.4	73.2	72.9	72.7	72.4	66.5	64.6	62.8
3000	81.6	76.7	76.2	75.6	75.4	75.1	74.8	74.5	68.4	66.5	64.7
3200	81.6	79.0	78.5	77.9	77.6	77.3	77.0	76.8	70.4	68.4	66.6
3400	81.6	81.3	80.7	80.1	79.8	79.5	79.2	79.0	72.4	70.3	68.4
3600	81.6	81.6	81.6	81.6	81.6	81.6	81.4	81.1	74.3	72.2	70.2
3800	81.6	81.6	81.6	81.6	81.6	81.6	81.6	81.6	76.1	73.9	71.9
4000	81.6	81.6	81.6	81.6	81.6	81.6	81.6	81.6	78.0	75.7	73.6
4200	81.6	81.6	81.6	81.6	81.6	81.6	81.6	81.6	79.7	77.4	75.2
4400	81.6	81.6	81.6	81.6	81.6	81.6	81.6	81.6	81.5	79.1	76.8
4600	81.6	81.6	81.6	81.6	81.6	81.6	81.6	81.6	81.6	80.7	78.4
CLIMB LIMIT WT (1000 KG)	63.0	62.5	62.4	62.3	62.3	62.2	62.2	62.1	55.0	52.8	50.7

1000 FT Pressure Altitude

CORR'D FIELD LENGTH (M)	FIELD LIMIT WEIGHT (1000 KG)										
	OAT										
	°C -40	14	18	22	24	26	28	30	42	46	50
°F -40	57	64	72	75	79	82	86	108	115	122	
1310	55.5	50.5	50.2	49.8	49.7	49.5	49.3	49.1	45.3	44.1	42.9
1400	57.5	52.2	51.9	51.5	51.4	51.2	51.0	50.8	46.8	45.6	44.3
1600	61.5	55.8	55.4	55.1	54.9	54.7	54.5	54.3	50.0	48.6	47.3
1800	65.1	59.1	58.7	58.3	58.1	57.9	57.7	57.4	52.9	51.5	50.1
2000	68.4	62.1	61.6	61.2	61.0	60.8	60.6	60.3	55.6	54.1	52.6
2200	71.5	64.9	64.5	64.0	63.8	63.6	63.4	63.1	58.1	56.5	55.0
2400	74.6	67.7	67.2	66.8	66.5	66.3	66.1	65.8	60.5	58.9	57.3
2600	77.6	70.3	69.9	69.4	69.1	68.9	68.6	68.3	62.9	61.1	59.5
2800	80.4	72.9	72.4	71.9	71.6	71.4	71.1	70.8	65.1	63.3	61.6
3000	81.6	75.1	74.5	74.0	73.8	73.5	73.2	72.9	67.1	65.2	63.4
3200	81.6	77.3	76.8	76.2	75.9	75.7	75.4	75.1	69.0	67.1	65.2
3400	81.6	79.5	78.9	78.4	78.1	77.8	77.6	77.2	70.9	68.9	67.0
3600	81.6	81.6	81.1	80.5	80.2	79.9	79.6	79.3	72.8	70.7	68.7
3800	81.6	81.6	81.6	81.6	81.6	81.6	81.6	81.3	74.6	72.4	70.4
4000	81.6	81.6	81.6	81.6	81.6	81.6	81.6	81.6	76.3	74.1	72.0
4200	81.6	81.6	81.6	81.6	81.6	81.6	81.6	81.6	78.1	75.8	73.6
4400	81.6	81.6	81.6	81.6	81.6	81.6	81.6	81.6	79.8	77.5	75.2
4600	81.6	81.6	81.6	81.6	81.6	81.6	81.6	81.6	81.4	79.1	76.7
CLIMB LIMIT WT (1000 KG)	62.7	62.1	62.1	62.0	61.9	61.9	61.8	61.7	54.8	52.5	50.4

Takeoff Field & Climb Limit Weights - Wet Runway

Flaps 5

2000 FT Pressure Altitude

CORR'D FIELD LENGTH (M)	FIELD LIMIT WEIGHT (1000 KG)										
	OAT										
	°C -40	14	18	22	24	26	28	30	42	46	50
°F -40	57	64	72	75	79	82	86	108	115	122	
1310	54.5	49.5	49.2	48.8	48.7	48.5	48.4	48.1	44.3	43.2	42.1
1400	56.4	51.2	50.9	50.5	50.3	50.2	50.0	49.7	45.8	44.6	43.4
1600	60.3	54.7	54.3	54.0	53.8	53.6	53.4	53.1	48.9	47.6	46.4
1800	63.9	57.9	57.5	57.1	56.9	56.7	56.5	56.2	51.8	50.4	49.1
2000	67.1	60.8	60.4	60.0	59.8	59.6	59.4	59.1	54.4	52.9	51.5
2200	70.2	63.6	63.2	62.8	62.6	62.3	62.1	61.8	56.9	55.3	53.9
2400	73.2	66.3	65.9	65.4	65.2	65.0	64.8	64.4	59.2	57.6	56.1
2600	76.1	68.9	68.4	68.0	67.7	67.5	67.3	66.9	61.5	59.8	58.2
2800	78.9	71.4	70.9	70.4	70.2	69.9	69.7	69.3	63.7	61.9	60.3
3000	81.3	73.5	73.0	72.5	72.3	72.0	71.8	71.4	65.6	63.8	62.1
3200	81.6	75.7	75.2	74.7	74.4	74.1	73.9	73.5	67.5	65.6	63.8
3400	81.6	77.9	77.3	76.8	76.5	76.2	76.0	75.5	69.3	67.4	65.5
3600	81.6	80.0	79.4	78.8	78.6	78.3	78.0	77.6	71.1	69.1	67.2
3800	81.6	81.6	81.4	80.8	80.5	80.3	80.0	79.5	72.9	70.8	68.9
4000	81.6	81.6	81.6	81.6	81.6	81.6	81.6	81.4	74.6	72.5	70.5
4200	81.6	81.6	81.6	81.6	81.6	81.6	81.6	81.6	76.3	74.1	72.0
4400	81.6	81.6	81.6	81.6	81.6	81.6	81.6	81.6	77.9	75.7	73.6
4600	81.6	81.6	81.6	81.6	81.6	81.6	81.6	81.6	79.5	77.2	75.1
CLIMB LIMIT WT (1000 KG)	62.4	61.9	61.8	61.8	61.7	61.7	61.6	61.4	54.3	52.0	49.9

3000 FT Pressure Altitude

CORR'D FIELD LENGTH (M)	FIELD LIMIT WEIGHT (1000 KG)										
	OAT										
	°C -40	14	18	22	24	26	28	30	42	46	50
°F -40	57	64	72	75	79	82	86	108	115	122	
1310	53.4	48.4	48.0	47.7	47.6	47.4	47.2	47.0	43.4	42.3	41.3
1400	55.2	50.0	49.7	49.3	49.2	49.0	48.8	48.6	44.9	43.7	42.6
1600	59.0	53.4	53.1	52.7	52.5	52.3	52.2	51.9	47.9	46.6	45.5
1800	62.5	56.6	56.2	55.8	55.6	55.4	55.2	54.9	50.7	49.4	48.1
2000	65.6	59.4	59.0	58.6	58.4	58.2	58.0	57.7	53.2	51.8	50.5
2200	68.7	62.2	61.7	61.3	61.1	60.9	60.7	60.3	55.6	54.2	52.8
2400	71.6	64.8	64.3	63.9	63.7	63.4	63.2	62.8	58.0	56.4	55.0
2600	74.4	67.3	66.8	66.4	66.1	65.9	65.7	65.3	60.2	58.6	57.1
2800	77.2	69.7	69.2	68.7	68.5	68.3	68.0	67.6	62.3	60.6	59.1
3000	79.5	71.8	71.3	70.8	70.5	70.3	70.0	69.6	64.2	62.5	60.8
3200	81.6	73.9	73.4	72.9	72.6	72.4	72.1	71.7	66.0	64.2	62.6
3400	81.6	76.0	75.5	74.9	74.6	74.4	74.1	73.7	67.8	66.0	64.2
3600	81.6	78.0	77.5	76.9	76.6	76.4	76.1	75.6	69.6	67.7	65.9
3800	81.6	80.0	79.4	78.8	78.6	78.3	78.0	77.5	71.3	69.3	67.4
4000	81.6	81.6	81.3	80.7	80.4	80.2	79.9	79.4	72.9	70.9	69.0
4200	81.6	81.6	81.6	81.6	81.6	81.6	81.6	81.2	74.6	72.5	70.5
4400	81.6	81.6	81.6	81.6	81.6	81.6	81.6	81.6	76.2	74.0	72.0
4600	81.6	81.6	81.6	81.6	81.6	81.6	81.6	81.6	77.7	75.6	73.5
CLIMB LIMIT WT (1000 KG)	61.8	61.4	61.3	61.2	61.2	61.1	61.1	60.7	53.8	51.6	49.6

Takeoff Obstacle Limit Weight

Flaps 5

Sea Level 30°C & Below, Zero Wind

Based on engine bleed for packs on and anti-ice off

Reference Obstacle Limit Weight (1000 KG)

OBSTACLE HEIGHT (M)	DISTANCE FROM BRAKE RELEASE (100 M)													
	25	30	35	40	45	50	55	60	65	70	75	80	85	90
5	62.2	64.9												
20	56.8	60.1	62.4	63.9	65.1	66.0								
40	52.1	55.5	58.1	60.0	61.6	62.8	63.7	64.4	65.1	65.6	66.1	66.5	66.9	67.2
60	48.6	52.0	54.7	56.9	58.6	60.0	61.2	62.1	62.9	63.5	64.1	64.6	65.1	65.5
80	45.8	49.2	52.0	54.2	56.1	57.6	58.9	60.0	60.9	61.7	62.4	62.9	63.5	63.9
100	43.4	46.8	49.6	51.9	53.8	55.5	56.8	58.0	59.0	59.9	60.7	61.4	62.0	62.5
120	41.3	44.7	47.6	49.9	51.9	53.6	55.0	56.3	57.3	58.3	59.1	59.9	60.5	61.1
140		42.9	45.7	48.1	50.1	51.8	53.3	54.6	55.8	56.8	57.7	58.5	59.2	59.8
160			44.0	46.5	48.5	50.3	51.8	53.2	54.3	55.4	56.3	57.2	57.9	58.6
180			42.5	44.9	47.0	48.8	50.4	51.8	53.0	54.1	55.1	55.9	56.7	57.5
200				43.5	45.6	47.5	49.1	50.5	51.7	52.9	53.9	54.8	55.6	56.4
220				42.2	44.4	46.2	47.8	49.3	50.6	51.7	52.7	53.7	54.5	55.3
240					43.2	45.0	46.7	48.1	49.4	50.6	51.7	52.6	53.5	54.3
260					42.0	43.9	45.6	47.1	48.4	49.6	50.7	51.6	52.5	53.4
280						42.9	44.5	46.0	47.4	48.6	49.7	50.7	51.6	52.4
300						41.9	43.5	45.1	46.4	47.6	48.8	49.8	50.7	51.6

When using line-up allowances, the obstacle distance from brake release must be reduced by the ASDA adjustment.

Obstacle height must be calculated from lowest point of the runway to conservatively account for runway slope.

OAT Adjustments

OAT (°C)	REFERENCE OBSTACLE LIMIT WEIGHT (1000 KG)							
	42	46	50	54	58	62	66	70
30 & BELOW	0	0	0	0	0	0	0	0
32	-0.8	-0.9	-1.0	-1.0	-1.1	-1.2	-1.3	-1.4
34	-1.6	-1.7	-1.9	-2.1	-2.2	-2.4	-2.6	-2.7
36	-2.4	-2.6	-2.9	-3.1	-3.4	-3.6	-3.9	-4.1
38	-3.2	-3.5	-3.8	-4.2	-4.5	-4.8	-5.2	-5.5
40	-4.0	-4.4	-4.8	-5.2	-5.6	-6.0	-6.4	-6.9
42	-4.7	-5.2	-5.7	-6.1	-6.6	-7.1	-7.6	-8.1
44	-5.4	-6.0	-6.5	-7.1	-7.7	-8.2	-8.8	-9.4
46	-6.1	-6.7	-7.4	-8.0	-8.7	-9.3	-10.0	-10.6
48	-6.8	-7.5	-8.3	-9.0	-9.7	-10.4	-11.2	-11.9
50	-7.5	-8.3	-9.1	-9.9	-10.7	-11.6	-12.4	-13.2

Pressure Altitude Adjustments

ALT (FT)	OAT ADJUSTED OBSTACLE LIMIT WEIGHT (1000 KG)							
	42	46	50	54	58	62	66	70
S.L. & BELOW	0	0	0	0	0	0	0	0
1000	-0.8	-0.8	-0.8	-0.8	-0.8	-0.9	-0.9	-0.9
2000	-1.6	-1.6	-1.6	-1.7	-1.7	-1.7	-1.8	-1.8
3000	-2.5	-2.5	-2.6	-2.7	-2.7	-2.8	-2.8	-2.9
4000	-3.4	-3.5	-3.6	-3.7	-3.7	-3.8	-3.9	-4.0
5000	-5.0	-5.2	-5.4	-5.6	-5.8	-6.0	-6.3	-6.5
6000	-6.5	-6.9	-7.2	-7.6	-7.9	-8.3	-8.6	-9.0
7000	-8.3	-8.8	-9.4	-9.9	-10.5	-11.0	-11.6	-12.1
8000	-10.0	-10.8	-11.5	-12.3	-13.0	-13.7	-14.5	-15.2
9000	-11.5	-12.5	-13.6	-14.6	-15.7	-16.7	-17.7	-18.8
10000	-13.0	-14.3	-15.6	-17.0	-18.3	-19.7	-21.0	-22.3

Takeoff Obstacle Limit Weight

Flaps 5

Sea Level 30°C & Below, Zero Wind

Based on engine bleed for packs on and anti-ice off

Wind Adjustments

WIND (KTS)	OAT & ALT ADJUSTED OBSTACLE LIMIT WEIGHT (1000 KG)							
	42	46	50	54	58	62	66	70
15 TW	-6.9	-6.5	-6.2	-5.8	-5.5	-5.1	-4.8	-4.5
10 TW	-4.6	-4.3	-4.1	-3.9	-3.7	-3.4	-3.2	-3.0
5 TW	-2.3	-2.2	-2.1	-1.9	-1.8	-1.7	-1.6	-1.5
0	0	0	0	0	0	0	0	0
10 HW	0.9	0.8	0.7	0.7	0.6	0.5	0.4	0.3
20 HW	1.8	1.6	1.5	1.3	1.1	1.0	0.8	0.6
30 HW	2.7	2.5	2.2	2.0	1.7	1.5	1.2	0.9
40 HW	3.7	3.3	3.0	2.6	2.3	2.0	1.6	1.3

With engine bleed for packs off, increase weight by 900 kg.

With engine anti-ice on, decrease weight by 200 kg.

With engine and wing anti-ice on, decrease weight by 850 kg (optional system).



Performance Dispatch

Chapter PD

Enroute

Section 21

Long Range Cruise Maximum Operating Altitude

Max Cruise Thrust

ISA + 10°C and Below

WEIGHT (1000 KG)	OPTIMUM ALT (FT)	TAT (°C)	MARGIN TO INITIAL BUFFET 'G' (BANK ANGLE)				
			1.20 (33°)	1.25 (36°)	1.30 (39°)	1.40 (44°)	1.50 (48°)
80	31000	-8	34400*	34400*	34300	32700	31300
75	32400	-11	35900*	35900*	35600	34100	32700
70	33900	-14	37300*	37300*	37100	35500	34200
65	35500	-18	38700*	38700*	38600	37100	35700
60	37100	-19	40200*	40200*	40200*	38800	37400
55	39000	-19	41000	41000	41000	40600	39200
50	40900	-19	41000	41000	41000	41000	41000
45	41000	-19	41000	41000	41000	41000	41000
40	41000	-19	41000	41000	41000	41000	41000
35	41000	-19	41000	41000	41000	41000	41000
30	41000	-19	41000	41000	41000	41000	41000

ISA + 15°C

WEIGHT (1000 KG)	OPTIMUM ALT (FT)	TAT (°C)	MARGIN TO INITIAL BUFFET 'G' (BANK ANGLE)				
			1.20 (33°)	1.25 (36°)	1.30 (39°)	1.40 (44°)	1.50 (48°)
80	31000	-2	33100*	33100*	33100*	32700	31300
75	32400	-5	34900*	34900*	34900*	34100	32700
70	33900	-8	36400*	36400*	36400*	35500	34200
65	35500	-12	37900*	37900*	37900*	37100	35700
60	37100	-13	39400*	39400*	39400*	38800	37400
55	39000	-13	40900*	40900*	40900*	40600	39200
50	40900	-13	41000	41000	41000	41000	41000
45	41000	-13	41000	41000	41000	41000	41000
40	41000	-13	41000	41000	41000	41000	41000
35	41000	-13	41000	41000	41000	41000	41000
30	41000	-13	41000	41000	41000	41000	41000

ISA + 20°C

WEIGHT (1000 KG)	OPTIMUM ALT (FT)	TAT (°C)	MARGIN TO INITIAL BUFFET 'G' (BANK ANGLE)				
			1.20 (33°)	1.25 (36°)	1.30 (39°)	1.40 (44°)	1.50 (48°)
80	31000	4	30800*	30800*	30800*	30800*	30800*
75	32400	0	33300*	33300*	33300*	33300*	32700
70	33900	-3	35200*	35200*	35200*	35200*	34200
65	35500	-6	36800*	36800*	36800*	36800*	35700
60	37100	-8	38300*	38300*	38300*	38300*	37400
55	39000	-8	39800*	39800*	39800*	39800*	39200
50	40900	-8	41000	41000	41000	41000	41000
45	41000	-8	41000	41000	41000	41000	41000
40	41000	-8	41000	41000	41000	41000	41000
35	41000	-8	41000	41000	41000	41000	41000
30	41000	-8	41000	41000	41000	41000	41000

*Denotes altitude thrust limited in level flight, 100 fpm residual rate of climb.

**Long Range Cruise Trip Fuel and Time
Ground to Air Miles Conversion**

AIR DISTANCE (NM)					GROUND DISTANCE (NM)	AIR DISTANCE (NM)				
HEADWIND COMPONENT (KTS)						TAILWIND COMPONENT (KTS)				
100	80	60	40	20		20	40	60	80	100
275	256	239	224	212	200	190	181	173	166	159
544	508	475	447	423	400	381	364	349	334	322
812	759	712	670	633	600	573	548	524	503	484
1081	1011	948	893	844	800	764	731	700	672	647
1348	1262	1184	1116	1055	1000	956	914	876	842	810
1614	1512	1419	1338	1266	1200	1147	1098	1052	1011	973
1880	1761	1654	1560	1476	1400	1338	1281	1228	1180	1136
2145	2011	1889	1782	1687	1600	1530	1464	1404	1349	1299
2409	2259	2123	2004	1897	1800	1721	1648	1580	1518	1462
2673	2507	2357	2225	2107	2000	1913	1831	1756	1688	1625
2936	2755	2591	2446	2317	2200	2104	2015	1932	1857	1788
3198	3002	2824	2667	2528	2400	2295	2198	2108	2026	1952
3460	3248	3057	2888	2738	2600	2487	2382	2285	2196	2115
3721	3495	3289	3109	2947	2800	2678	2565	2461	2365	2278
3982	3741	3522	3329	3157	3000	2870	2749	2637	2535	2442
4242	3986	3754	3550	3367	3200	3062	2933	2814	2705	2606
4501	4232	3987	3770	3577	3400	3253	3117	2991	2875	2770
4760	4477	4219	3991	3787	3600	3445	3301	3167	3045	2933
5019	4721	4451	4211	3996	3800	3637	3485	3344	3215	3097
5278	4966	4682	4431	4206	4000	3828	3668	3521	3385	3261
5536	5210	4914	4651	4416	4200	4020	3852	3697	3555	3425
5794	5455	5145	4871	4625	4400	4211	4036	3874	3725	3589
6052	5698	5376	5091	4835	4600	4403	4220	4050	3894	3752
6310	5942	5607	5310	5044	4800	4594	4403	4227	4064	3916
6567	6185	5838	5530	5253	5000	4786	4587	4403	4234	4080

Long Range Cruise Trip Fuel and Time
Reference Fuel and Time Required

AIR DIST (NM)	PRESSURE ALTITUDE (1000 FT)									
	29		31		33		35		37	
	FUEL (1000 KG)	TIME (HR:MIN)	FUEL (1000 KG)	TIME (HR:MIN)	FUEL (1000 KG)	TIME (HR:MIN)	FUEL (1000 KG)	TIME (HR:MIN)	FUEL (1000 KG)	TIME (HR:MIN)
200	1.3	0:38	1.3	0:37	1.3	0:36	1.3	0:36	1.4	0:36
400	2.3	1:09	2.3	1:08	2.2	1:07	2.2	1:05	2.2	1:04
600	3.3	1:41	3.2	1:39	3.2	1:37	3.1	1:35	3.1	1:33
800	4.3	2:13	4.2	2:10	4.1	2:07	4.0	2:04	3.9	2:01
1000	5.2	2:44	5.1	2:41	5.0	2:37	4.9	2:33	4.8	2:29
1200	6.3	3:15	6.1	3:10	6.0	3:06	5.8	3:01	5.7	2:57
1400	7.3	3:46	7.1	3:40	6.9	3:35	6.7	3:29	6.6	3:24
1600	8.3	4:16	8.1	4:10	7.9	4:04	7.7	3:57	7.5	3:52
1800	9.3	4:47	9.1	4:40	8.8	4:33	8.6	4:26	8.4	4:20
2000	10.4	5:18	10.1	5:10	9.8	5:02	9.5	4:54	9.3	4:48
2200	11.4	5:47	11.1	5:39	10.8	5:30	10.5	5:22	10.2	5:15
2400	12.5	6:17	12.2	6:07	11.8	5:58	11.5	5:49	11.2	5:42
2600	13.6	6:46	13.2	6:36	12.8	6:26	12.4	6:17	12.1	6:10
2800	14.7	7:16	14.2	7:05	13.8	6:54	13.4	6:45	13.1	6:37
3000	15.7	7:45	15.3	7:33	14.8	7:22	14.4	7:12	14.0	7:04
3200	16.9	8:14	16.4	8:01	15.9	7:49	15.4	7:39	15.1	7:31
3400	18.0	8:42	17.5	8:29	16.9	8:17	16.4	8:07	16.1	7:58
3600	19.1	9:10	18.6	8:57	18.0	8:44	17.5	8:34	17.1	8:25
3800	20.3	9:39	19.7	9:24	19.1	9:12	18.5	9:01	18.1	8:52
4000	21.4	10:07	20.8	9:52	20.1	9:39	19.5	9:28	19.1	9:19
4200	22.6	10:34	21.9	10:19	21.2	10:06	20.6	9:55	20.2	9:45
4400	23.8	11:02	23.1	10:47	22.4	10:33	21.7	10:22	21.3	10:12
4600	25.0	11:29	24.2	11:14	23.5	11:00	22.8	10:49	22.4	10:39
4800	26.2	11:57	25.4	11:41	24.6	11:27	23.9	11:15	23.5	11:05
5000	27.4	12:24	26.5	12:08	25.7	11:54	25.0	11:42	24.6	11:32

Fuel Required Adjustments (1000 KG)

REFERENCE FUEL REQUIRED (1000 KG)	LANDING WEIGHT (1000 KG)				
	30	40	45	50	60
5	-0.7	-0.3	0.0	0.3	1.1
10	-1.4	-0.5	0.0	0.7	2.4
15	-2.1	-0.8	0.0	1.1	4.0
20	-2.9	-1.1	0.0	1.6	6.0
25	-3.7	-1.3	0.0	2.2	8.2
30	-4.6	-1.6	0.0	2.8	10.7

Based on .78/.78 climb, Long Range Cruise and .78/280/250 descent.

**Long Range Cruise Step Climb
Ground to Air Miles Conversion**

AIR DISTANCE (NM)					GROUND DISTANCE (NM)	AIR DISTANCE (NM)				
HEADWIND COMPONENT (KTS)						TAILWIND COMPONENT (KTS)				
100	80	60	40	20	20	40	60	80	100	
1320	1241	1170	1107	1051	1000	954	912	873	838	805
1837	1729	1633	1547	1470	1400	1336	1278	1225	1176	1131
2354	2217	2096	1987	1889	1800	1719	1645	1577	1515	1457
2870	2705	2558	2427	2308	2200	2102	2012	1930	1854	1784
3386	3193	3021	2866	2727	2600	2485	2379	2282	2193	2110
3902	3680	3483	3306	3145	3000	2867	2746	2635	2532	2437
4417	4168	3945	3745	3564	3400	3250	3113	2987	2871	2764
4932	4655	4407	4184	3983	3800	3633	3480	3340	3211	3091
5447	5141	4869	4623	4401	4200	4016	3848	3693	3550	3418
5961	5628	5330	5062	4820	4600	4399	4215	4046	3890	3745
6475	6114	5791	5501	5239	5000	4782	4583	4399	4229	4072

Trip Fuel and Time Required

AIR DIST (NM)	TRIP FUEL (1000 KG)					TIME (HRS:MIN)
	LANDING WEIGHT (1000 KG)					
	30	40	50	60	70	
1000	3.8	4.4	5.1	5.9	6.6	2:28
1400	5.2	6.0	7.0	8.1	9.1	3:23
1800	6.5	7.6	8.9	10.3	11.7	4:17
2200	8.0	9.3	10.9	12.7	14.4	5:12
2600	9.4	11.0	12.9	15.0	17.1	6:06
3000	10.9	12.7	15.1	17.5	20.0	7:00
3400	12.4	14.5	17.2	20.0	22.9	7:53
3800	14.0	16.4	19.5	22.7	25.9	8:47
4200	15.6	18.3	21.8	25.4	29.0	9:40
4600	17.2	20.3	24.2	28.1	32.2	10:34
5000	18.8	22.3	26.6	31.0	35.4	11:27

Based on 280/.78 climb, Long Range Cruise or .78 cruise and .78/280/250 descent.
Valid for all pressure altitudes with 4000 ft step climb to 2000 ft above optimum altitude.

Short Trip Fuel and Time Ground to Air Miles Conversion

AIR DISTANCE (NM)					GROUND DISTANCE (NM)	AIR DISTANCE (NM)				
HEADWIND COMPONENT (KTS)						TAILWIND COMPONENT (KTS)				
100	80	60	40	20		20	40	60	80	100
92	79	69	61	55	50	46	42	39	37	34
158	142	128	117	108	100	93	87	82	77	73
224	204	187	173	161	150	141	133	125	119	113
288	265	245	228	213	200	188	178	169	161	153
351	325	302	283	265	250	236	224	213	203	194
415	385	360	337	318	300	284	270	257	246	235
478	445	417	392	370	350	332	316	302	288	276
541	506	474	447	422	400	380	362	346	331	317
606	567	532	502	474	450	428	408	390	373	358
672	629	591	557	527	500	476	453	433	415	398

Trip Fuel and Time Required

AIR DIST (NM)		LANDING WEIGHT (1000 KG)					TIME (HRS:MIN)
		30	40	50	60	70	
50	FUEL (1000 KG)	0.5	0.5	0.6	0.6	0.7	0:14
	ALT (FT)	13000	11000	11000	9000	9000	
100	FUEL (1000 KG)	0.7	0.8	0.9	1.0	1.1	0:22
	ALT (FT)	21000	19000	19000	17000	17000	
150	FUEL (1000 KG)	0.9	1.1	1.2	1.3	1.4	0:30
	ALT (FT)	29000	25000	25000	23000	23000	
200	FUEL (1000 KG)	1.1	1.3	1.5	1.6	1.8	0:37
	ALT (FT)	41000	35000	29000	27000	25000	
250	FUEL (1000 KG)	1.3	1.5	1.7	1.9	2.1	0:44
	ALT (FT)	41000	41000	37000	31000	29000	
300	FUEL (1000 KG)	1.4	1.7	1.9	2.1	2.4	0:50
	ALT (FT)	41000	41000	39000	35000	31000	
350	FUEL (1000 KG)	1.6	1.9	2.1	2.4	2.7	0:57
	ALT (FT)	41000	41000	39000	35000	33000	
400	FUEL (1000 KG)	1.8	2.1	2.4	2.7	3.0	1:04
	ALT (FT)	41000	41000	39000	35000	33000	
450	FUEL (1000 KG)	1.9	2.2	2.6	2.9	3.3	1:11
	ALT (FT)	41000	41000	39000	35000	33000	
500	FUEL (1000 KG)	2.1	2.4	2.8	3.2	3.6	1:19
	ALT (FT)	41000	41000	39000	35000	33000	

Holding Planning Flaps Up

WEIGHT (1000 KG)	TOTAL FUEL FLOW (KG/HR)								
	PRESSURE ALTITUDE (FT)								
	1500	5000	10000	15000	20000	25000	30000	35000	41000
80	2890	2850	2830	2810	2770	2780	2850		
75	2720	2680	2650	2640	2590	2590	2650	2800	
70	2560	2510	2490	2470	2420	2400	2450	2540	
65	2400	2350	2320	2290	2260	2220	2270	2320	
60	2230	2190	2160	2130	2100	2040	2080	2110	
55	2070	2030	1990	1960	1930	1880	1900	1920	2100
50	1910	1860	1830	1800	1760	1720	1720	1760	1860
45	1760	1700	1660	1660	1620	1600	1570	1580	1650
40	1640	1580	1530	1490	1460	1440	1420	1400	1460
35	1480	1430	1380	1340	1310	1280	1270	1240	1280
30	1330	1290	1230	1190	1160	1140	1110	1100	1110

This table includes 5% additional fuel for holding in a racetrack pattern.

Flight Crew Oxygen Requirements

Required Pressure (PSI) for 76 Cu. Ft. Cylinder

BOTTLE TEMPERATURE		NUMBER OF CREW USING OXYGEN		
°C	°F	2	3	4
50	122	735	1055	1360
45	113	725	1040	1340
40	104	715	1020	1320
35	95	700	1005	1300
30	86	690	990	1280
25	77	680	975	1255
20	68	670	960	1240
15	59	655	940	1215
10	50	645	925	1195
5	41	635	910	1175
0	32	620	890	1150
-5	23	610	875	1130
-10	14	600	860	1110

Required Pressure (PSI) for 114/115 Cu. Ft. Cylinder

BOTTLE TEMPERATURE		NUMBER OF CREW USING OXYGEN		
°C	°F	2	3	4
50	122	530	735	945
45	113	520	725	930
40	104	510	715	915
35	95	505	700	900
30	86	495	690	885
25	77	485	680	870
20	68	480	670	860
15	59	470	655	840
10	50	460	645	830
5	41	455	635	815
0	32	445	620	800
-5	23	440	610	785
-10	14	430	600	770

ENGINE INOP

MAX CONTINUOUS THRUST

Net Level Off Weight

PRESSURE ALTITUDE (1000 FT)	LEVEL OFF WEIGHT (1000 KG)		
	ISA + 10° & BELOW	ISA + 15°C	ISA + 20°C
30	43.5	42.3	
28	47.3	45.9	44.4
26	51.4	49.8	48.3
24	54.8	53.1	51.4
22	57.3	55.4	53.4
20	59.8	57.4	54.6
18	61.3	58.3	55.0
16	61.9	58.7	55.8
14	64.1	61.1	58.2
12	66.7	63.5	60.3
10	69.4	66.0	62.8
8	72.3	68.9	65.6
6	75.3	71.8	68.3

Anti-Ice Adjustments

ANTI-ICE CONFIGURATION	LEVEL OFF WEIGHT ADJUSTMENT (1000 KG)												
	PRESSURE ALTITUDE (1000 FT)												
	6	8	10	12	14	16	18	20	22	24	26	28	30
ENGINE ONLY	-2.2	-2.1	-2.2	-2.0	-1.8	-1.9	-1.9	-1.9	-1.5	-1.3	-1.2	-1.1	-1.0
ENGINE & WING	-8.0	-7.9	-7.8	-7.5	-7.0	-7.0	-7.0	-6.7	-5.9	-5.0	-4.5	-4.3	

ALL ENGINES

Long Range Cruise Critical Fuel Reserves Ground to Air Miles Conversion

AIR DISTANCE (NM)					GROUND DISTANCE (NM)	AIR DISTANCE (NM)				
HEADWIND COMPONENT (KTS)						TAILWIND COMPONENT (KTS)				
100	80	60	40	20	20	40	60	80	100	
290	266	246	228	213	200	188	178	169	160	153
593	541	497	460	428	400	376	354	335	317	302
897	816	749	692	643	600	563	530	501	474	451
1201	1091	1000	923	857	800	750	706	667	631	600
1505	1367	1252	1155	1072	1000	937	882	832	788	749
1809	1642	1504	1387	1287	1200	1124	1058	998	945	898
2113	1917	1755	1618	1501	1400	1312	1234	1164	1102	1047
2417	2193	2007	1850	1716	1600	1499	1409	1330	1260	1196
2721	2468	2259	2082	1931	1800	1686	1585	1496	1417	1345

Critical Fuel (1000 KG)

AIR DIST (NM)	WEIGHT AT CRITICAL POINT (1000 KG)									
	40	45	50	55	60	65	70	75	80	
200	1.8	1.8	1.9	2.0	2.1	2.1	2.2	2.3	2.4	
300	2.5	2.6	2.7	2.8	2.9	3.0	3.1	3.2	3.3	
400	3.2	3.3	3.4	3.6	3.7	3.8	4.0	4.1	4.2	
500	3.9	4.1	4.2	4.4	4.5	4.7	4.8	5.0	5.2	
600	4.6	4.8	5.0	5.2	5.3	5.5	5.7	5.9	6.1	
700	5.3	5.5	5.7	5.9	6.1	6.3	6.6	6.8	7.0	
800	6.0	6.2	6.5	6.7	6.9	7.2	7.4	7.6	7.9	
900	6.7	7.0	7.2	7.5	7.7	8.0	8.2	8.5	8.8	
1000	7.4	7.7	7.9	8.2	8.5	8.8	9.1	9.4	9.7	
1100	8.2	8.4	8.7	9.0	9.3	9.6	9.9	10.3	10.6	
1200	8.9	9.1	9.4	9.8	10.1	10.4	10.8	11.1	11.5	
1300	9.6	9.8	10.1	10.5	10.9	11.2	11.6	12.0	12.3	
1400	10.3	10.5	10.9	11.3	11.7	12.0	12.4	12.8	13.2	
1500	11.0	11.2	11.6	12.0	12.4	12.8	13.2	13.7	14.1	
1600	11.7	11.9	12.3	12.7	13.2	13.6	14.0	14.5	15.0	
1700	12.4	12.6	13.0	13.5	13.9	14.4	14.9	15.3	15.8	
1800	13.1	13.3	13.7	14.2	14.7	15.2	15.7	16.2	16.7	

Based on: Emergency descent to 10000 ft. Level cruise at 10000 ft. 250 KIAS descent to 1500 ft. 15 minute hold at 1500 ft. One missed approach; approach and land. 5% allowance for wind errors.

Increase fuel required 0.5% for each 10°C hotter than ISA conditions.

If icing conditions exists, increase fuel by 16% to account for engine and wing anti-ice on (6%) and ice accumulation on unheated surfaces (10%).

Allowance for performance deterioration not included.

Compare the fuel required from this chart with critical fuel reserves for one engine inoperative and use the higher of the two.

ENGINE INOP

MAX CONTINUOUS THRUST

Long Range Cruise Critical Fuel Reserves Ground to Air Miles Conversion

AIR DISTANCE (NM)					GROUND DISTANCE (NM)	AIR DISTANCE (NM)				
HEADWIND COMPONENT (KTS)						TAILWIND COMPONENT (KTS)				
100	80	60	40	20		20	40	60	80	100
295	269	248	230	214	200	188	177	168	159	151
604	548	502	463	429	400	375	352	333	315	299
914	827	756	696	644	600	561	528	497	471	447
1224	1106	1010	929	860	800	748	703	662	627	594
1533	1385	1264	1162	1075	1000	935	878	827	782	742
1843	1665	1518	1395	1290	1200	1122	1053	992	938	890
2153	1944	1772	1628	1505	1400	1309	1228	1157	1094	1037
2462	2223	2026	1861	1721	1600	1495	1403	1322	1250	1185
2772	2502	2280	2094	1936	1800	1682	1579	1487	1406	1333

Critical Fuel (1000 KG)

AIR DIST (NM)	WEIGHT AT CRITICAL POINT (1000 KG)								
	40	45	50	55	60	65	70	75	80
200	1.6	1.6	1.7	1.8	1.9	2.0	2.0	2.1	2.2
300	2.2	2.3	2.4	2.5	2.6	2.7	2.8	3.0	3.1
400	2.8	2.9	3.1	3.2	3.4	3.5	3.7	3.8	3.9
500	3.4	3.6	3.8	3.9	4.1	4.3	4.5	4.6	4.8
600	4.1	4.3	4.5	4.7	4.9	5.1	5.3	5.5	5.7
700	4.7	4.9	5.1	5.4	5.6	5.8	6.1	6.3	6.5
800	5.3	5.6	5.8	6.1	6.3	6.6	6.9	7.1	7.4
900	5.9	6.2	6.5	6.8	7.0	7.3	7.6	7.9	8.2
1000	6.5	6.8	7.1	7.4	7.8	8.1	8.4	8.7	9.1
1100	7.2	7.4	7.8	8.1	8.5	8.8	9.2	9.6	9.9
1200	7.8	8.1	8.4	8.8	9.2	9.6	10.0	10.4	10.8
1300	8.4	8.7	9.1	9.5	9.9	10.3	10.8	11.2	11.6
1400	9.0	9.3	9.7	10.2	10.6	11.1	11.5	11.9	12.4
1500	9.6	9.9	10.4	10.9	11.3	11.8	12.3	12.7	13.2
1600	10.3	10.5	11.0	11.5	12.0	12.5	13.0	13.5	14.0
1700	10.9	11.2	11.7	12.2	12.7	13.2	13.7	14.3	14.8
1800	11.5	11.8	12.3	12.8	13.4	13.9	14.5	15.1	15.6

Based on: Emergency descent to 10000 ft. Level cruise at 10000 ft. 250 KIAS descent to 1500 ft. 15 minutes hold at 1500 ft. One missed approach; approach and land. 5% allowance for wind errors.

Increase fuel required 0.5% for each 10°C hotter than ISA conditions.

If icing conditions exists, increase fuel by 15% to account for engine and wing anti-ice on (7%) and ice accumulation on unheated surfaces (8%).

Allowance for performance deterioration not included.

Compare the fuel required from this chart with critical fuel reserves for all engines operative and use the higher of the two.

Intentionally
Blank



Performance Dispatch
Landing

Chapter PD
Section 22

Landing Field Limit Weight - Dry Runway
Flaps 40

Based on anti-skid operative and automatic speedbrakes
Wind Corrected Field Length (M)

FIELD LENGTH AVAILABLE (M)	WIND COMPONENT (KTS)							
	-15	-10	-5	0	10	20	30	40
1000			880	1000	1050	1110	1180	1250
1200	880	980	1080	1200	1260	1320	1400	1470
1400	1060	1160	1270	1400	1460	1540	1610	1700
1600	1230	1350	1460	1600	1670	1750	1830	1920
1800	1410	1530	1650	1800	1870	1960	2050	2140
2000	1590	1720	1840	2000	2080	2170	2270	2370
2200	1760	1900	2030	2200	2280	2380	2480	2590
2400	1940	2090	2230	2400	2490	2590	2700	2810
2600	2120	2270	2420	2600	2690	2800	2920	3040
2800	2220	2370	2520	2800	2900	3010	3140	
3000	2320	2470	2610	3000	3100			
3200	2420	2560	2710	3200				
3400	2510	2650	2800					
3600	2610	2740	2890					
3800	2710	2840	2990					
4000	2800	2930	3080					
4200	2900	3020	3170					
4400	3000	3120						
4600	3090							
4800	3190							

Field Limit Weight (1000 KG)

WIND CORR'D FIELD LENGTH (M)	AIRPORT PRESSURE ALTITUDE (FT)					
	0	2000	4000	6000	8000	10000
1200	47.5	44.7	42.0	39.4		
1400	57.3	54.7	51.8	48.7	45.7	42.7
1600	65.7	62.6	59.7	56.8	54.1	50.8
1800	74.7	70.7	67.0	63.6	60.5	57.5
2000	81.8	78.8	74.7	70.7	66.9	63.4
2200			81.2	78.0	73.7	69.6
2400				83.0	79.8	76.0
2600						80.6

Decrease field limit weight by 4500 kg when using manual speedbrakes.

737 Flight Crew Operations Manual

Landing Field Limit Weight - Dry Runway

Flaps 40

Based on anti-skid inoperative and manual speedbrakes

Wind Corrected Field Length (M)

FIELD LENGTH AVAILABLE (M)	WIND COMPONENT (KTS)							
	-15	-10	-5	0	10	20	30	40
1800				1800	1940	2090	2250	2410
2000			1750	2000	2140	2310	2470	2640
2200		1700	1940	2200	2350	2520	2680	2860
2400	1650	1880	2130	2400	2560	2730	2900	3080
2600	1830	2070	2330	2600	2760	2940	3120	3300
2800	2010	2260	2520	2800	2970	3150	3330	3530
3000	2190	2440	2710	3000	3180	3360	3550	3750
3200	2370	2630	2910	3200	3380	3570	3770	3970
3400	2540	2810	3100	3400	3590	3790	3980	4200
3600	2720	3000	3290	3600	3790	4000	4200	4420
3800	2900	3190	3480	3800	4000	4210	4420	4640
4000	3080	3370	3680	4000	4210	4420	4630	4860
4200	3260	3560	3870	4200	4410	4630	4850	5090
4400	3430	3740	4060	4400	4620	4840	5070	5310
4600	3610	3930	4250	4600	4830	5050	5280	5530
4800	3790	4120	4450	4800	5030	5270	5500	5760
5000	3970	4300	4640	5000	5240	5480	5720	
5200	4150	4490	4830	5200	5440	5690		
5400	4320	4680	5030	5400	5650			
5600	4500	4860	5220	5600				

Field Limit Weight (1000 KG)

WIND CORR'D FIELD LENGTH (M)	AIRPORT PRESSURE ALTITUDE (FT)					
	0	2000	4000	6000	8000	10000
2200	42.8	40.2				
2400	48.0	45.1	41.9	39.1		
2600	53.2	50.1	46.5	43.5	40.5	
2800	58.5	55.0	51.2	47.9	44.7	41.6
3000	63.7	59.9	55.9	52.2	48.9	45.4
3200	69.2	64.7	60.5	56.5	52.9	49.3
3400	75.0	70.0	64.9	60.8	56.8	53.0
3600	80.3	75.3	69.8	64.9	60.7	56.7
3800		80.3	74.7	69.5	64.6	60.3
4000			79.5	74.1	68.8	64.0
4200				78.7	73.1	67.8
4400				82.9	77.6	71.8
4600					81.5	76.0
4800						79.8
5000						83.5

Landing Field Limit Weight - Wet Runway

Flaps 40

Based on anti-skid operative and automatic speedbrakes

Wind Corrected Field Length (M)

FIELD LENGTH AVAILABLE (M)	WIND COMPONENT (KTS)							
	-15	-10	-5	0	10	20	30	40
1000				1000	1060	1120	1190	1270
1200		960	1070	1200	1260	1330	1410	1490
1400	1030	1140	1260	1400	1470	1540	1630	1720
1600	1210	1330	1450	1600	1670	1760	1850	1940
1800	1380	1510	1640	1800	1880	1970	2060	2160
2000	1560	1700	1830	2000	2080	2180	2280	2390
2200	1740	1880	2020	2200	2290	2390	2500	2610
2400	1910	2070	2220	2400	2490	2600	2720	2830
2600	2090	2250	2410	2600	2700	2810	2930	3060
2800	2270	2440	2600	2800	2900	3020	3150	3280
3000	2440	2620	2790	3000	3110	3230	3370	3500
3200	2550	2720	2890	3200	3310	3450	3590	
3400	2640	2810	2980	3400	3510	3660		
3600	2740	2910	3080	3600				
3800	2840	3000	3170					
4000	2930	3090	3260					
4200	3030	3180	3350					
4400	3130	3280	3450					
4600	3220	3370	3540					
4800	3320	3460	3630					

Field Limit Weight (1000 KG)

WIND CORR'D FIELD LENGTH (M)	AIRPORT PRESSURE ALTITUDE (FT)					
	0	2000	4000	6000	8000	10000
1200	39.1					
1400	48.5	45.6	42.9	40.2		
1600	57.0	54.4	51.4	48.3	45.3	42.4
1800	64.2	61.3	58.4	55.6	52.8	49.5
2000	71.9	68.2	64.7	61.5	58.5	55.6
2200	79.2	75.4	71.4	67.5	64.0	60.8
2400		81.2	78.1	73.8	69.8	66.0
2600			82.7	79.6	75.8	71.5
2800					80.6	77.1
3000						80.7

Decrease field limit weight by 4500 kg when using manual speedbrakes.

737 Flight Crew Operations Manual

Landing Field Limit Weight - Wet Runway

Flaps 40

Based on anti-skid inoperative and manual speedbrakes

Wind Corrected Field Length (M)

FIELD LENGTH AVAILABLE (M)	WIND COMPONENT (KTS)							
	-15	-10	-5	0	10	20	30	40
1800					1950	2120	2300	2470
2000				2000	2160	2330	2510	2700
2200			1910	2200	2360	2550	2730	2920
2400			2110	2400	2570	2760	2950	3140
2600		2020	2300	2600	2770	2970	3160	3370
2800	1940	2200	2490	2800	2980	3180	3380	3590
3000	2120	2390	2690	3000	3190	3390	3590	3810
3200	2290	2580	2880	3200	3390	3600	3810	4030
3400	2470	2760	3070	3400	3600	3810	4030	4260
3600	2650	2950	3260	3600	3810	4030	4250	4480
3800	2830	3130	3460	3800	4010	4240	4460	4700
4000	3010	3320	3650	4000	4220	4450	4680	4930
4200	3180	3510	3840	4200	4420	4660	4900	5150
4400	3360	3690	4030	4400	4630	4870	5110	5370
4600	3540	3880	4230	4600	4840	5080	5330	5590
4800	3720	4060	4420	4800	5040	5290	5550	5820
5000	3900	4250	4610	5000	5250	5510	5760	6040
5200	4070	4440	4810	5200	5460	5720	5980	6260
5400	4250	4620	5000	5400	5660	5930	6200	6490
5600	4430	4810	5190	5600	5870	6140	6410	

Field Limit Weight (1000 KG)

WIND CORR'D FIELD LENGTH (M)	AIRPORT PRESSURE ALTITUDE (FT)					
	0	2000	4000	6000	8000	10000
2400	39.9					
2600	44.4					
2800	48.9			39.9		
3000	53.5	50.3	46.7	43.7	40.7	
3200	58.0	54.6	50.8	47.5	44.3	41.2
3400	62.5	58.9	54.8	51.3	47.9	44.6
3600	67.2	63.1	58.9	55.0	51.5	47.9
3800	72.2	67.4	62.8	58.7	54.9	51.2
4000	77.2	72.0	66.8	62.4	58.3	54.4
4200	81.7	76.7	71.0	66.1	61.7	57.6
4400		80.9	75.4	70.1	65.2	60.8
4600			79.5	74.1	68.8	64.0
4800			83.5	78.1	72.6	67.3
5000				81.8	76.4	70.8
5200					80.0	74.3
5400					83.4	77.9
5600						81.1

Landing Climb Limit Weight

Valid for approach with Flaps 15 and landing with Flaps 40

Based on engine bleed for packs on and anti-ice off

AIRPORT OAT		LANDING CLIMB LIMIT WEIGHT (1000 KG)			
		AIRPORT PRESSURE ALTITUDE (FT)			
°C	°F	0	1000	2000	3000
50	122	51.4	51.1	50.6	
48	118	52.5	52.1	51.7	51.3
46	115	53.6	53.2	52.7	52.3
44	111	54.6	54.4	53.8	53.4
42	108	55.8	55.5	55.0	54.5
40	104	56.9	56.6	56.1	55.6
38	100	58.0	57.7	57.3	56.7
36	97	59.2	58.9	58.4	57.9
34	93	60.3	60.0	59.5	59.0
32	90	61.6	61.2	60.7	60.2
30	86	62.8	62.4	62.0	61.3
28	82	62.9	62.5	62.2	61.7
26	79	63.0	62.6	62.3	61.7
24	75	63.0	62.6	62.3	61.8
22	72	63.1	62.7	62.4	61.8
20	68	63.1	62.7	62.4	61.8
18	64	63.2	62.8	62.5	61.9
16	61	63.2	62.8	62.5	61.9
14	57	63.2	62.8	62.5	62.0
12	54	63.3	62.9	62.6	62.0
10	50	63.3	62.9	62.6	62.0
-40	-40	63.8	63.4	63.1	62.5

With engine bleed for packs off, increase weight by 1400 kg.

With engine anti-ice on, decrease weight by 150 kg.

With engine and wing anti-ice on, decrease weight by 750 kg.

When operating in icing conditions during any part of the flight with forecast landing temperature below 10°C, decrease weight by 5150 kg.

ENGINE INOP

Go-Around Climb Gradient

Flaps 15

Based on engine bleed for packs on and anti-ice off

OAT (°C)	REFERENCE GO-AROUND GRADIENT (%)					
	PRESSURE ALTITUDE (FT)					
	0	2000	4000	6000	8000	10000
54	1.46					
50	1.98	1.79				
46	2.50	2.30	2.09			
42	3.05	2.86	2.59	1.63		
38	3.61	3.41	3.16	2.08	0.72	
34	4.18	3.97	3.71	2.59	1.14	
30	4.78	4.57	4.26	3.09	1.63	0.11
29	4.79	4.63	4.35	3.21	1.75	0.23
26	4.81	4.65	4.37	3.58	2.10	0.56
25	4.82	4.65	4.37	3.67	2.21	0.67
22	4.84	4.67	4.39	3.68	2.56	1.00
18	4.86	4.69	4.41	3.69	3.00	1.43
14	4.88	4.71	4.42	3.71	3.04	1.89
10	4.91	4.73	4.44	3.72	3.05	2.36
6	4.93	4.75	4.46	3.74	3.06	2.38
2	4.94	4.77	4.47	3.75	3.08	2.39

Gradient Adjustment for Weight (%)

WEIGHT (1000 KG)	REFERENCE GO-AROUND GRADIENT (%)					
	0	1	2	3	4	5
70	-2.87	-3.26	-3.56	-3.87	-4.18	-4.48
65	-2.33	-2.65	-2.89	-3.14	-3.39	-3.63
60	-1.71	-1.94	-2.11	-2.29	-2.47	-2.64
55	-0.94	-1.06	-1.15	-1.25	-1.35	-1.44
50	0.00	0.00	0.00	0.00	0.00	0.00
45	1.14	1.26	1.38	1.51	1.64	1.77
40	2.61	2.87	3.14	3.42	3.72	4.02

Gradient Adjustment for Speed (%)

SPEED (KIAS)	WEIGHT ADJUSTED GO-AROUND GRADIENT (%)										
	0	1	2	3	4	5	6	7	8	9	10
VREF40	-0.35	-0.37	-0.38	-0.38	-0.39	-0.39	-0.39	-0.39	-0.39	-0.39	-0.39
VREF40+5	0.00	0.00	0.00	0.00	0.00	0.00	0.00	0.00	0.00	0.00	0.00
VREF40+10	0.20	0.21	0.21	0.21	0.21	0.21	0.21	0.21	0.21	0.21	0.21
VREF40+15	0.33	0.33	0.33	0.33	0.32	0.31	0.30	0.30	0.29	0.28	0.28
VREF40+20	0.39	0.37	0.36	0.34	0.32	0.30	0.28	0.27	0.26	0.25	0.23
VREF40+25	0.39	0.34	0.29	0.25	0.22	0.19	0.16	0.14	0.13	0.11	0.09
VREF40+30	0.31	0.22	0.14	0.08	0.03	-0.01	-0.04	-0.06	-0.08	-0.10	-0.13

With engine bleed for packs off, increase gradient by 0.3%.

With engine anti-ice on, decrease gradient by 0.1%.

With engine and wing anti-ice on, decrease gradient by 0.2%.

When operating in icing conditions during any part of the flight with forecast landing temperatures below 10°C decrease gradient by 0.9%.

Quick Turnaround Limit Weight Flaps 40

OAT (°C)	LIMIT WEIGHT (1000 KG)					
	AIRPORT PRESSURE ALTITUDE (FT)					
	0	2000	4000	6000	8000	10000
54	71.8					
50	72.3	69.4				
45	72.9	70.0	67.1			
40	73.5	70.6	67.7	64.9		
35	74.2	71.2	68.3	65.5	62.8	
30	74.9	71.8	68.9	66.0	63.4	60.8
25	75.6	72.5	69.5	66.6	63.9	61.3
20	76.3	73.1	70.1	67.2	64.4	61.8
15	77.0	73.8	70.8	67.8	65.0	62.4
10	77.7	74.5	71.4	68.5	65.6	62.9
5	78.4	75.2	72.1	69.1	66.2	63.5
0	79.1	76.0	72.8	69.8	66.9	64.1
-5	79.9	76.7	73.5	70.5	67.5	64.6
-10	80.6	77.5	74.3	71.2	68.2	65.3
-15	81.4	78.3	75.1	71.9	68.9	65.9
-20	81.6	79.0	75.9	72.7	69.6	66.6
-30	81.6	80.7	77.5	74.2	71.1	68.0
-40	81.6	81.6	79.2	75.9	72.7	69.6
-50	81.6	81.6	80.9	77.7	74.4	71.2
-54	81.6	81.6	81.6	78.4	75.1	71.8

Increase weight by 650 kg per 1% uphill slope. Decrease weight by 1150 kg per 1% downhill slope.
 Increase weight by 1600 kg per 10 knots headwind. Decrease weight by 8000 kg per 10 knots tailwind.

After landing at weights exceeding those shown above, adjusted for slope and wind, wait at least 62 minutes and check that wheel thermal plugs have not melted before executing a subsequent takeoff.

As an alternate procedure, ensure that each brake pressure plate surface temperature, without artificial cooling, is less than 218°C as follows: No sooner than 10 and no later than 15 minutes after parking, measure each brake pressure plate surface temperature at a minimum of two points per brake by an accurate method (using a Doric Microtemp 450 hand held thermometer or equivalent, hold temperature probe in place for 20 seconds or until reading stabilizes). If each measured temperature is less than 218°C, immediate dispatch is allowed; otherwise the required minimum ground wait period of 62 minutes applies.

If a Brake Temperature Monitoring System (BTMS) is installed:

No sooner than 10 and no later than 15 minutes after parking, check the BRAKE TEMP light. If the BRAKE TEMP light is not on, no ground waiting period is required. If the BRAKE TEMP light is on, do not dispatch until at least 62 minutes after landing, or until all the BTMS readings on the systems Display are below 3.5 and the BRAKE TEMP light is off. Check that wheel thermal plugs have not melted before making a subsequent takeoff.

Note: If any brake temperature display digit is blank or indicates 0.0 or 0.1, then this method cannot be used.

Intentionally
Blank

Performance Dispatch

Chapter PD

Text

Section 23

Introduction

This chapter contains self dispatch performance data intended primarily for use by flight crews in the event that information cannot be obtained from the airline dispatch office. The takeoff data provided is for a single takeoff flap at max takeoff thrust. The range of conditions covered is limited to those normally encountered in airline operation. In the event of conflict between the data presented in this chapter and that contained in the approved Airplane Flight Manual, the Flight Manual shall always take precedence.

Takeoff

The maximum allowable takeoff weight will be the least of the Field, Climb and Obstacle Limit Weights as determined from the tables shown. Tire and Brake Energy Limits are not shown as they are not limiting for the range of conditions shown in this chapter.

JAROPS-1 requires that the runway length be adjusted to account for alignment of the airplane prior to takeoff. The table below provides TORA, TODA and ASDA adjustments for both 90 degree taxiway entry and 180 degree turnaround. For the 180 degree turnaround case, adjustments are provided for both a nominal 60 m runway as well as the minimum required for the stated minimum pavement width. These values may be used when obtaining takeoff weights from the Airplane Flight Manual or a takeoff analysis program. When using line-up allowances with the Field Length Limit chart, the field length available must be reduced by the ASDA adjustment.

	90 DEGREE TAXIWAY ENTRY	180 DEGREE TURNAROUND	
	MINIMUM LINE-UP DISTANCE (M)	NOMINAL LINE-UP DISTANCE (M) (60.0 M RUNWAY)	MINIMUM LINE-UP DISTANCE (M) (26.0 M RUNWAY)
TORA & TODA	9.9	16.4	16.4
ASDA	22.5	29.0	29.0

Field Limit Weight - Slope and Wind Corrections

These tables for dry and wet runways provide corrections to the field length available for the effects of runway slope and wind component along the runway. Enter the appropriate table with the available field length and runway slope to determine the slope corrected field length. Next enter the appropriate table with slope corrected field length and wind component to determine the slope and wind corrected field length.

Field and Climb Limit Weight

Tables are presented for selected airport pressure altitudes and runway conditions and show both Field and Climb Limit Weights. Enter the appropriate table for pressure altitude and runway condition with “Slope and Wind Corrected Field Length” determined above and airport OAT to obtain Field Limit Weight. Also read Climb Limit Weight for the same OAT. Intermediate altitudes may be interpolated or use next higher altitude. When finding a maximum weight for a wet runway, the dry runway limit weight must also be determined and the lower of the two weights used.

Obstacle Limit Weight

The Reference Obstacle Limit Weight table provides obstacle limit weights for reference airport conditions based on obstacle height above the runway surface and distance from brake release. Enter the adjustment tables to adjust the reference Obstacle Limit Weight for the effects of OAT, pressure altitude and wind as indicated. In the case of multiple obstacles, enter the tables successively with each obstacle and determine the most limiting weight.

When using line-up allowances with the Obstacle Limit chart, the obstacle distance from brake release must be reduced by the ASDA adjustment.

Enroute

Long Range Cruise Maximum Operating Altitude

These tables provide the maximum operating altitude in the same manner as the FMC. Maximum altitudes are shown for a given cruise weight and maneuver capability. Note that this table considers both thrust and buffet limits, providing the more limiting of the two. Any data that is thrust limited is denoted by an asterisk and represents only a thrust limited condition in level flight with 100 ft/min residual rate of climb. Flying above these altitudes with sustained banks in excess of approximately 15° may cause the airplane to lose speed and/or altitude. The altitudes shown in the table are limited to the maximum certified altitude of 41000 ft.

Long Range Cruise Trip Fuel and Time

Long Range Cruise Trip Fuel and Time tables are provided to determine trip time and fuel required to destination.

To determine trip fuel and time for a constant altitude cruise, first enter the Ground to Air Miles Conversion table to convert ground distance and enroute wind to an equivalent still air distance for use with the Reference Fuel and Time tables. Next, enter the Reference Fuel and Time table with

air distance from the Ground to Air Miles Conversion table and the desired altitude and read Reference Fuel and Time Required. Lastly, enter the Fuel Required Adjustment table with the Reference Fuel and the planned landing weight to obtain the adjustment to the fuel required at the planned landing weight.

Long Range Cruise Step Climb Trip Fuel and Time

The Long Range Cruise Step Climb Trip Fuel and Time tables are provided to determine trip time and fuel required to destination when flying a step climb profile. Step climb profiles are based on 4000 ft step climbs to keep the flight within 2000 ft of the optimum altitude for the current cruise weight. To determine trip fuel and time, enter the Ground to Air Miles Conversion table and determine air distance as discussed above. Then enter the Trip Fuel and Time Required table with air distance and planned landing weight to read trip fuel. Continue across the table to read trip time.

Short Trip Fuel and Time

These tables are provided to determine trip fuel and time for short distances or alternates. Obtain air distance from the table using the ground distance and wind component to the alternate. Enter the Trip Fuel and Time Required table with air distance and read trip fuel required for the expected landing weight, together with time to alternate at right. For distances greater than shown or other altitudes, use the Long Range Cruise Trip Fuel and Time tables.

Holding Planning

This table provides total fuel flow information necessary for planning flaps up holding and reserve fuel requirements. Data is based on the FMC holding speed schedule which is the higher of the maximum endurance and flaps up maneuver speeds. As noted, the fuel flow is based on flight in a racetrack holding pattern. For holding in straight and level flight, reduce table values by 5%.

Flight Crew Oxygen Requirements

Regulations require that sufficient oxygen be provided to the flight crew to account for the greater of supplemental breathing oxygen in the event of a cabin depressurization or protective breathing in the event of smoke or harmful fumes in the flight deck. The oxygen quantity associated with the above requirements is achieved with the minimum dispatch oxygen cylinder pressure.

To determine the minimum dispatch oxygen cylinder pressure enter the appropriate flight crew oxygen table with the number of crew plus observers using oxygen and read the minimum cylinder pressure required for the appropriate cylinder temperature.

Net Level Off Weight

The Net Level Off Weight table is provided to determine terrain clearance capability in straight and level flight following an engine failure. Regulations require terrain clearance planning based on net performance which is the gross (or actual) gradient performance degraded by 1.1%. In addition, the net level off pressure altitude must clear the terrain by 1000 ft.

To determine the maximum weight for terrain clearance, enter the table with required net level off pressure altitude and expected ISA deviation to obtain weight. Adjust weight for anti-ice operation as noted below the table.

Extended Range Operations

Regulations require that flights conducted over a route that contains a point further than one hour's time at "normal one engine inoperative speed" from an adequate diversion airport comply with rules set up specifically for "Extended Range Operation with Two Engine airplanes." This section provides reserve fuel planning information for the "Critical Fuel Scenario" based on two engine operation at Long Range Cruise as well as single engine operation at Long Range Cruise.

Long Range Cruise Critical Fuel Reserves

Enter the Ground to Air Miles Conversion table with forecast wind and ground distance to diversion airport from critical point to obtain air distance. Now enter the Critical Fuel table with air distance and expected weight at the critical point and read required fuel. Apply the noted fuel adjustments as necessary. Regulations require a 5% allowance for performance deterioration unless a value has been established by the operator for inservice deterioration.

As noted below each table, the fuel required is the greater of the two engine fuel and the single engine fuel. This fuel is compared to the amount of fuel normally onboard the airplane at that point in the route. If the fuel required by the critical fuel reserves exceeds the amount of fuel normally expected, the fuel load must be adjusted accordingly.

Landing

Tables are provided for determining the maximum landing weight as limited by field length or climb requirements for a single landing flap.

Maximum landing weight is the lowest of the field length limit weight, climb limit weight, or maximum certified landing weight.

Landing Field Limit Weight

For the expected runway condition and anti-skid system configuration, obtain wind corrected field length by entering the Wind Corrected Field Length table with field length available and wind component along the runway. Now enter the Field Limit Weight table with wind corrected field length and pressure altitude to read field limit weight.

Landing Climb Limit Weight

Enter the table with airport OAT and pressure altitude to read landing climb limit weight. Apply the noted adjustments as required.

Go-Around Climb Gradient

Enter the Reference Go-Around Gradient table with airport OAT and pressure altitude to determine the reference go-around gradient. Then adjust the reference gradient for airplane weight and speed using the tables provided to determine the weight and speed adjusted go-around gradient. Apply the necessary corrections for engine bleed configuration and icing conditions as noted.

Quick Turnaround Limit Weight

Enter the table with airport pressure altitude and OAT to read maximum quick turnaround weight. Apply the noted adjustments as required.

If the landing weight exceeds the maximum quick turnaround weight, wait the specified time and then check that the wheel thermal plugs have not melted before executing a subsequent takeoff, or ensure the brake temperature is within limits using the alternate procedure described on the page.

Intentionally
Blank



Performance Dispatch
Takeoff

Chapter PD
Section 30

Takeoff Field Corrections - Dry Runway
Slope Corrections

FIELD LENGTH AVAILABLE (M)	SLOPE CORRECTED FIELD LENGTH (M)								
	RUNWAY SLOPE (%)								
	-2.0	-1.5	-1.0	-0.5	0.0	0.5	1.0	1.5	2.0
1200	1230	1220	1210	1210	1200	1190	1170	1160	1140
1400	1450	1440	1430	1410	1400	1370	1350	1320	1300
1600	1670	1650	1640	1620	1600	1560	1530	1490	1450
1800	1900	1870	1850	1820	1800	1750	1700	1650	1600
2000	2120	2090	2060	2030	2000	1940	1880	1820	1760
2200	2340	2310	2270	2240	2200	2130	2060	1980	1910
2400	2560	2520	2480	2440	2400	2320	2230	2150	2060
2600	2790	2740	2690	2650	2600	2500	2410	2310	2220
2800	3010	2960	2900	2850	2800	2690	2590	2480	2370
3000	3230	3170	3120	3060	3000	2880	2760	2640	2520
3200	3450	3390	3330	3260	3200	3070	2940	2810	2680
3400	3680	3610	3540	3470	3400	3260	3120	2970	2830
3600	3900	3820	3750	3670	3600	3450	3290	3140	2980
3800	4130	4050	3970	3880	3800	3630	3470	3300	3140
4000	4370	4280	4190	4090	4000	3820	3650	3470	3290
4200	4610	4510	4410	4300	4200	4010	3820	3630	3440
4400	4850	4740	4630	4510	4400	4200	4000	3800	3600
4600	5090	4970	4850	4720	4600	4390	4180	3960	3750
4800	5330	5200	5070	4930	4800	4580	4350	4130	3900
5000	5570	5430	5290	5140	5000	4760	4530	4290	4060

Wind Corrections

SLOPE CORR'D FIELD LENGTH (M)	SLOPE & WIND CORRECTED FIELD LENGTH (M)							
	WIND COMPONENT (KTS)							
	-15	-10	-5	0	10	20	30	40
1200	880	990	1090	1200	1260	1320	1390	1470
1400	1050	1170	1280	1400	1460	1530	1610	1690
1600	1220	1350	1470	1600	1670	1740	1820	1910
1800	1390	1530	1660	1800	1870	1950	2040	2130
2000	1560	1700	1850	2000	2080	2160	2250	2350
2200	1720	1880	2040	2200	2280	2370	2470	2570
2400	1890	2060	2230	2400	2490	2580	2680	2790
2600	2060	2240	2420	2600	2690	2790	2900	3010
2800	2230	2420	2610	2800	2900	3000	3110	3230
3000	2400	2600	2800	3000	3100	3210	3330	3460
3200	2570	2780	2990	3200	3310	3420	3540	3680
3400	2730	2960	3180	3400	3510	3630	3760	3900
3600	2900	3130	3370	3600	3720	3840	3970	4120
3800	3070	3310	3560	3800	3920	4050	4190	4340
4000	3240	3490	3750	4000	4130	4260	4410	4560
4200	3410	3670	3940	4200	4330	4470	4620	4780
4400	3570	3850	4120	4400	4540	4680	4840	5000
4600	3740	4030	4310	4600	4740	4890	5050	5220
4800	3910	4210	4500	4800	4950	5100	5270	5440
5000	4080	4390	4690	5000	5150	5310	5480	5660

737 Flight Crew Operations Manual

Takeoff Field & Climb Limit Weights - Dry Runway

Flaps 5

Sea Level Pressure Altitude

CORR'D FIELD LENGTH (M)	FIELD LIMIT WEIGHT (1000 KG)											
	OAT											
	°C	-40	14	18	22	24	26	28	30	42	46	50
	°F	-40	57	64	72	75	79	82	86	108	115	122
1400	63.2	58.2	57.8	57.4	57.3	57.1	56.9	56.7	52.7	51.4	50.1	
1600	68.3	62.9	62.5	62.1	61.9	61.7	61.5	61.3	57.0	55.6	54.2	
1800	73.1	67.2	66.8	66.4	66.2	66.0	65.8	65.5	61.0	59.4	57.9	
2000	77.7	71.3	70.9	70.4	70.2	70.0	69.8	69.5	64.6	62.9	61.3	
2200	81.8	75.1	74.6	74.2	73.9	73.7	73.4	73.2	67.9	66.2	64.4	
2400	85.7	78.6	78.1	77.6	77.4	77.1	76.8	76.6	71.0	69.2	67.3	
2600	86.2	81.8	81.3	80.8	80.5	80.3	80.0	79.7	73.9	72.0	70.0	
2800	86.2	84.9	84.4	83.8	83.6	83.3	83.0	82.7	76.7	74.7	72.7	
3000	86.2	86.2	86.2	86.2	86.2	86.0	85.7	85.5	79.2	77.1	75.0	
3200	86.2	86.2	86.2	86.2	86.2	86.2	86.2	86.2	81.4	79.2	77.1	
3400	86.2	86.2	86.2	86.2	86.2	86.2	86.2	86.2	83.5	81.3	79.1	
3600	86.2	86.2	86.2	86.2	86.2	86.2	86.2	86.2	85.5	83.3	81.0	
3800	86.2	86.2	86.2	86.2	86.2	86.2	86.2	86.2	86.2	85.2	82.9	
4000	86.2	86.2	86.2	86.2	86.2	86.2	86.2	86.2	86.2	86.2	84.7	
4200	86.2	86.2	86.2	86.2	86.2	86.2	86.2	86.2	86.2	86.2	86.2	
4400	86.2	86.2	86.2	86.2	86.2	86.2	86.2	86.2	86.2	86.2	86.2	
4600	86.2	86.2	86.2	86.2	86.2	86.2	86.2	86.2	86.2	86.2	86.2	
CLIMB LIMIT WT (1000 KG)	82.5	81.9	81.8	81.6	81.6	81.5	81.4	81.4	73.5	71.0	68.5	

1000 FT Pressure Altitude

CORR'D FIELD LENGTH (M)	FIELD LIMIT WEIGHT (1000 KG)											
	OAT											
	°C	-40	14	18	22	24	26	28	30	42	46	50
	°F	-40	57	64	72	75	79	82	86	108	115	122
1400	61.5	56.6	56.2	55.9	55.7	55.5	55.4	54.8	51.0	49.7	48.4	
1600	66.5	61.2	60.8	60.4	60.3	60.1	59.9	59.3	55.1	53.7	52.4	
1800	71.2	65.4	65.0	64.6	64.4	64.2	64.0	63.4	58.9	57.4	56.0	
2000	75.6	69.4	69.0	68.5	68.3	68.1	67.9	67.2	62.4	60.8	59.2	
2200	79.6	73.1	72.6	72.1	71.9	71.7	71.4	70.7	65.6	63.9	62.2	
2400	83.3	76.4	75.9	75.5	75.2	75.0	74.7	74.0	68.6	66.8	65.0	
2600	86.2	79.6	79.1	78.5	78.3	78.0	77.8	77.0	71.3	69.5	67.6	
2800	86.2	82.6	82.0	81.5	81.2	81.0	80.7	79.9	74.0	72.1	70.1	
3000	86.2	85.3	84.8	84.2	83.9	83.6	83.4	82.5	76.4	74.4	72.4	
3200	86.2	86.2	86.2	86.2	86.2	86.0	85.7	84.8	78.5	76.5	74.4	
3400	86.2	86.2	86.2	86.2	86.2	86.2	86.2	86.2	80.6	78.4	76.3	
3600	86.2	86.2	86.2	86.2	86.2	86.2	86.2	86.2	82.5	80.3	78.2	
3800	86.2	86.2	86.2	86.2	86.2	86.2	86.2	86.2	84.4	82.2	80.0	
4000	86.2	86.2	86.2	86.2	86.2	86.2	86.2	86.2	86.2	84.0	81.7	
4200	86.2	86.2	86.2	86.2	86.2	86.2	86.2	86.2	86.2	85.7	83.4	
4400	86.2	86.2	86.2	86.2	86.2	86.2	86.2	86.2	86.2	86.2	85.1	
4600	86.2	86.2	86.2	86.2	86.2	86.2	86.2	86.2	86.2	86.2	86.2	
CLIMB LIMIT WT (1000 KG)	80.6	80.0	79.9	79.8	79.7	79.7	79.6	78.5	71.1	68.7	66.3	

With engine bleed for packs off, increase field limit weight by 400 kg and climb limit weight by 1250 kg.
 With engine anti-ice on, decrease field limit weight by 200 kg and climb limit weight by 200 kg.
 With engine and wing anti-ice on (optional system), decrease field limit weight by 750 kg and climb limit weight by 1350 kg.

Takeoff Field & Climb Limit Weights - Dry Runway

Flaps 5

2000 FT Pressure Altitude

CORR'D FIELD LENGTH (M)	FIELD LIMIT WEIGHT (1000 KG)										
	OAT										
	°C -40	14	18	22	24	26	28	30	42	46	50
°F -40	57	64	72	75	79	82	86	108	115	122	
1400	60.0	55.0	54.7	54.3	54.2	54.0	53.5	53.0	49.2	48.0	46.8
1600	64.9	59.5	59.1	58.8	58.6	58.4	57.9	57.3	53.3	51.9	50.6
1800	69.4	63.6	63.2	62.8	62.6	62.4	61.9	61.3	56.9	55.5	54.0
2000	73.7	67.4	67.0	66.6	66.4	66.2	65.6	64.9	60.2	58.7	57.2
2200	77.6	71.0	70.5	70.1	69.8	69.6	69.0	68.3	63.3	61.7	60.0
2400	81.2	74.2	73.7	73.3	73.0	72.8	72.1	71.4	66.2	64.4	62.7
2600	84.5	77.3	76.8	76.3	76.0	75.8	75.1	74.3	68.8	67.0	65.2
2800	86.2	80.2	79.6	79.1	78.9	78.6	77.9	77.1	71.4	69.5	67.6
3000	86.2	82.8	82.3	81.7	81.5	81.2	80.5	79.6	73.7	71.8	69.8
3200	86.2	85.1	84.5	84.0	83.7	83.5	82.7	81.8	75.8	73.8	71.8
3400	86.2	86.2	86.2	86.1	85.9	85.6	84.8	83.9	77.7	75.7	73.6
3600	86.2	86.2	86.2	86.2	86.2	86.2	86.2	86.0	79.6	77.5	75.4
3800	86.2	86.2	86.2	86.2	86.2	86.2	86.2	86.2	81.4	79.3	77.1
4000	86.2	86.2	86.2	86.2	86.2	86.2	86.2	86.2	83.2	81.0	78.8
4200	86.2	86.2	86.2	86.2	86.2	86.2	86.2	86.2	84.9	82.7	80.5
4400	86.2	86.2	86.2	86.2	86.2	86.2	86.2	86.2	86.2	84.3	82.1
4600	86.2	86.2	86.2	86.2	86.2	86.2	86.2	86.2	86.2	85.9	83.6
CLIMB LIMIT WT (1000 KG)	78.6	78.0	78.0	77.9	77.8	77.8	76.9	75.9	68.7	66.4	64.1

3000 FT Pressure Altitude

CORR'D FIELD LENGTH (M)	FIELD LIMIT WEIGHT (1000 KG)										
	OAT										
	°C -40	14	18	22	24	26	28	30	42	46	50
°F -40	57	64	72	75	79	82	86	108	115	122	
1400	58.1	53.2	52.9	52.6	52.4	52.0	51.6	51.1	47.5	46.3	45.2
1600	62.9	57.6	57.2	56.9	56.7	56.3	55.8	55.3	51.4	50.2	48.9
1800	67.2	61.5	61.1	60.8	60.6	60.1	59.6	59.1	55.0	53.6	52.3
2000	71.3	65.2	64.8	64.4	64.2	63.7	63.2	62.5	58.1	56.6	55.2
2200	75.1	68.6	68.1	67.7	67.5	67.0	66.4	65.8	61.1	59.5	58.0
2400	78.6	71.7	71.3	70.8	70.6	70.0	69.4	68.7	63.8	62.1	60.5
2600	81.8	74.6	74.2	73.7	73.5	72.9	72.2	71.5	66.4	64.6	63.0
2800	84.9	77.4	76.9	76.5	76.2	75.6	74.9	74.2	68.8	67.0	65.3
3000	86.2	80.0	79.5	79.0	78.7	78.1	77.4	76.6	71.1	69.2	67.4
3200	86.2	82.2	81.7	81.1	80.9	80.2	79.5	78.8	73.0	71.1	69.3
3400	86.2	84.3	83.8	83.2	83.0	82.3	81.6	80.8	74.9	72.9	71.1
3600	86.2	86.2	85.8	85.2	85.0	84.3	83.6	82.7	76.7	74.7	72.8
3800	86.2	86.2	86.2	86.2	86.2	86.2	85.5	84.6	78.5	76.4	74.4
4000	86.2	86.2	86.2	86.2	86.2	86.2	86.2	86.2	80.2	78.1	76.1
4200	86.2	86.2	86.2	86.2	86.2	86.2	86.2	86.2	81.9	79.7	77.6
4400	86.2	86.2	86.2	86.2	86.2	86.2	86.2	86.2	83.5	81.3	79.2
4600	86.2	86.2	86.2	86.2	86.2	86.2	86.2	86.2	85.1	82.8	80.7
CLIMB LIMIT WT (1000 KG)	76.2	75.7	75.6	75.5	75.5	74.8	74.1	73.2	66.4	64.2	62.0

With engine bleed for packs off, increase field limit weight by 400 kg and climb limit weight by 1250 kg.
 With engine anti-ice on, decrease field limit weight by 200 kg and climb limit weight by 200 kg.
 With engine and wing anti-ice on (optional system), decrease field limit weight by 750 kg and climb limit weight by 1350 kg.

Takeoff Field Corrections - Wet Runway

Slope Corrections

FIELD LENGTH AVAILABLE (M)	SLOPE CORRECTED FIELD LENGTH (M)								
	RUNWAY SLOPE (%)								
	-2.0	-1.5	-1.0	-0.5	0.0	0.5	1.0	1.5	2.0
1200	1200	1200	1200	1200	1200	1190	1170	1160	1140
1400	1430	1420	1420	1410	1400	1380	1360	1330	1310
1600	1670	1650	1630	1620	1600	1570	1540	1510	1480
1800	1900	1870	1850	1820	1800	1760	1720	1680	1650
2000	2130	2100	2070	2030	2000	1950	1910	1860	1810
2200	2360	2320	2280	2240	2200	2150	2090	2040	1980
2400	2600	2550	2500	2450	2400	2340	2280	2210	2150
2600	2830	2770	2720	2660	2600	2530	2460	2390	2320
2800	3060	3000	2930	2870	2800	2720	2640	2560	2490
3000	3300	3220	3150	3070	3000	2910	2830	2740	2650
3200	3530	3450	3370	3280	3200	3110	3010	2920	2820
3400	3760	3670	3580	3490	3400	3300	3200	3090	2990
3600	4000	3900	3800	3700	3600	3490	3380	3270	3160
3800	4230	4120	4020	3910	3800	3680	3560	3450	3330
4000	4460	4350	4230	4120	4000	3870	3750	3620	3500
4200	4700	4570	4450	4320	4200	4070	3930	3800	3670
4400	4930	4800	4670	4530	4400	4260	4120	3980	3830
4600	5160	5020	4880	4740	4600	4450	4300	4150	4000
4800	5400	5250	5100	4950	4800	4640	4490	4330	4170
5000	5630	5470	5320	5160	5000	4840	4670	4510	4340

Wind Corrections

SLOPE CORR'D FIELD LENGTH (M)	SLOPE & WIND CORRECTED FIELD LENGTH (M)							
	WIND COMPONENT (KTS)							
	-15	-10	-5	0	10	20	30	40
1200	860	970	1090	1200	1280	1360	1440	1520
1400	1030	1150	1280	1400	1480	1570	1660	1750
1600	1200	1330	1470	1600	1690	1790	1880	1980
1800	1370	1510	1660	1800	1900	2000	2100	2210
2000	1540	1690	1850	2000	2110	2210	2330	2440
2200	1710	1870	2040	2200	2310	2430	2550	2670
2400	1880	2050	2230	2400	2520	2640	2770	2900
2600	2050	2230	2420	2600	2730	2860	2990	3130
2800	2220	2410	2610	2800	2930	3070	3210	3360
3000	2390	2590	2800	3000	3140	3280	3430	3590
3200	2560	2770	2990	3200	3350	3500	3650	3820
3400	2730	2950	3180	3400	3550	3710	3880	4050
3600	2900	3130	3370	3600	3760	3930	4100	4270
3800	3070	3310	3560	3800	3970	4140	4320	4500
4000	3240	3490	3750	4000	4170	4360	4540	4730
4200	3410	3670	3940	4200	4380	4570	4760	4960
4400	3580	3850	4130	4400	4590	4780	4980	5190
4600	3740	4030	4310	4600	4800	5000	5210	5420
4800	3910	4210	4500	4800	5000	5210	5430	5650
5000	4080	4390	4690	5000	5210	5430	5650	5880

**Takeoff Field & Climb Limit Weights - Wet Runway
 Flaps 5**

Sea Level Pressure Altitude

CORR'D FIELD LENGTH (M)	FIELD LIMIT WEIGHT (1000 KG)											
	OAT											
	°C	-40	14	18	22	24	26	28	30	42	46	50
	°F	-40	57	64	72	75	79	82	86	108	115	122
1400	63.3	57.6	57.2	56.8	56.6	56.4	56.2	55.9	52.0	50.7	49.4	
1600	68.3	62.2	61.7	61.3	61.1	60.8	60.6	60.4	56.1	54.7	53.3	
1800	72.9	66.3	65.9	65.4	65.2	64.9	64.7	64.5	59.9	58.4	56.9	
2000	77.2	70.2	69.7	69.2	69.0	68.7	68.5	68.2	63.4	61.8	60.2	
2200	81.2	73.9	73.3	72.8	72.6	72.3	72.0	71.8	66.7	65.0	63.3	
2400	85.0	77.3	76.7	76.2	75.9	75.7	75.4	75.1	69.7	67.9	66.2	
2600	86.2	80.6	80.0	79.4	79.1	78.8	78.5	78.2	72.6	70.7	68.9	
2800	86.2	83.6	83.0	82.4	82.1	81.8	81.5	81.2	75.3	73.4	71.5	
3000	86.2	86.2	85.6	85.0	84.7	84.4	84.0	83.7	77.7	75.7	73.7	
3200	86.2	86.2	86.2	86.2	86.2	86.2	86.2	86.2	80.0	77.9	75.9	
3400	86.2	86.2	86.2	86.2	86.2	86.2	86.2	86.2	82.2	80.1	78.0	
3600	86.2	86.2	86.2	86.2	86.2	86.2	86.2	86.2	84.3	82.2	80.0	
3800	86.2	86.2	86.2	86.2	86.2	86.2	86.2	86.2	86.2	84.1	81.9	
4000	86.2	86.2	86.2	86.2	86.2	86.2	86.2	86.2	86.2	86.1	83.8	
4200	86.2	86.2	86.2	86.2	86.2	86.2	86.2	86.2	86.2	86.2	85.6	
4400	86.2	86.2	86.2	86.2	86.2	86.2	86.2	86.2	86.2	86.2	86.2	
4600	86.2	86.2	86.2	86.2	86.2	86.2	86.2	86.2	86.2	86.2	86.2	
CLIMB LIMIT WT (1000 KG)	82.5	81.9	81.8	81.6	81.6	81.5	81.4	81.4	73.5	71.0	68.5	

1000 FT Pressure Altitude

CORR'D FIELD LENGTH (M)	FIELD LIMIT WEIGHT (1000 KG)											
	OAT											
	°C	-40	14	18	22	24	26	28	30	42	46	50
	°F	-40	57	64	72	75	79	82	86	108	115	122
1400	61.5	55.9	55.5	55.1	54.9	54.7	54.5	53.9	50.2	49.0	47.7	
1600	66.4	60.3	59.9	59.5	59.3	59.1	58.8	58.2	54.2	52.9	51.5	
1800	70.9	64.4	63.9	63.5	63.2	63.0	62.8	62.1	57.8	56.4	55.0	
2000	75.0	68.1	67.6	67.2	66.9	66.7	66.5	65.8	61.2	59.7	58.2	
2200	78.9	71.6	71.1	70.6	70.4	70.1	69.9	69.2	64.3	62.7	61.1	
2400	82.6	75.0	74.4	73.9	73.6	73.4	73.1	72.4	67.3	65.6	63.9	
2600	86.1	78.1	77.5	77.0	76.7	76.4	76.2	75.4	70.0	68.3	66.5	
2800	86.2	81.0	80.5	79.9	79.6	79.3	79.0	78.2	72.7	70.8	69.0	
3000	86.2	83.6	83.0	82.4	82.1	81.8	81.5	80.6	74.9	73.0	71.1	
3200	86.2	86.1	85.5	84.9	84.6	84.3	83.9	83.0	77.1	75.2	73.2	
3400	86.2	86.2	86.2	86.2	86.2	86.2	86.2	85.4	79.3	77.2	75.2	
3600	86.2	86.2	86.2	86.2	86.2	86.2	86.2	86.2	81.3	79.2	77.2	
3800	86.2	86.2	86.2	86.2	86.2	86.2	86.2	86.2	83.3	81.1	79.0	
4000	86.2	86.2	86.2	86.2	86.2	86.2	86.2	86.2	85.2	83.0	80.8	
4200	86.2	86.2	86.2	86.2	86.2	86.2	86.2	86.2	86.2	84.8	82.6	
4400	86.2	86.2	86.2	86.2	86.2	86.2	86.2	86.2	86.2	86.2	84.3	
4600	86.2	86.2	86.2	86.2	86.2	86.2	86.2	86.2	86.2	86.2	86.0	
CLIMB LIMIT WT (1000 KG)	80.6	80.0	79.9	79.8	79.7	79.7	79.6	78.5	71.1	68.7	66.3	

With engine bleed for packs off, increase field limit weight by 350 kg and climb limit weight by 1250 kg.
 With engine anti-ice on, decrease field limit weight by 150 kg and climb limit weight by 200 kg.
 With engine and wing anti-ice on (optional system), decrease field limit weight by 750 kg and climb limit weight by 1350 kg.

737 Flight Crew Operations Manual

Takeoff Field & Climb Limit Weights - Wet Runway

Flaps 5

2000 FT Pressure Altitude

CORR'D FIELD LENGTH (M)	FIELD LIMIT WEIGHT (1000 KG)											
	OAT											
	°C	-40	14	18	22	24	26	28	30	42	46	50
	°F	-40	57	64	72	75	79	82	86	108	115	122
1400	59.8	54.2	53.8	53.4	53.2	53.0	52.6	52.1	48.5	47.3	46.1	
1600	64.5	58.5	58.1	57.7	57.5	57.3	56.8	56.2	52.3	51.0	49.7	
1800	68.9	62.4	62.0	61.5	61.3	61.1	60.6	60.0	55.8	54.5	53.1	
2000	72.9	66.0	65.6	65.1	64.9	64.7	64.1	63.5	59.1	57.6	56.1	
2200	76.7	69.4	69.0	68.5	68.2	68.0	67.4	66.7	62.1	60.5	59.0	
2400	80.3	72.6	72.1	71.6	71.4	71.1	70.5	69.8	64.9	63.3	61.7	
2600	83.7	75.7	75.1	74.6	74.3	74.1	73.4	72.7	67.5	65.8	64.1	
2800	86.2	78.5	78.0	77.4	77.1	76.9	76.2	75.4	70.1	68.3	66.5	
3000	86.2	81.0	80.4	79.8	79.6	79.3	78.5	77.8	72.3	70.4	68.6	
3200	86.2	83.4	82.8	82.2	81.9	81.6	80.9	80.1	74.4	72.5	70.6	
3400	86.2	85.7	85.1	84.5	84.2	83.9	83.1	82.3	76.4	74.5	72.5	
3600	86.2	86.2	86.2	86.2	86.2	86.2	86.1	85.3	84.5	78.4	76.4	74.4
3800	86.2	86.2	86.2	86.2	86.2	86.2	86.2	86.2	86.2	80.3	78.2	76.2
4000	86.2	86.2	86.2	86.2	86.2	86.2	86.2	86.2	86.2	82.1	80.0	77.9
4200	86.2	86.2	86.2	86.2	86.2	86.2	86.2	86.2	86.2	83.9	81.7	79.6
4400	86.2	86.2	86.2	86.2	86.2	86.2	86.2	86.2	86.2	85.7	83.4	81.2
4600	86.2	86.2	86.2	86.2	86.2	86.2	86.2	86.2	86.2	86.2	85.1	82.9
CLIMB LIMIT WT (1000 KG)	78.6	78.0	78.0	77.9	77.8	77.8	76.9	75.9	68.7	66.4	64.1	

3000 FT Pressure Altitude

CORR'D FIELD LENGTH (M)	FIELD LIMIT WEIGHT (1000 KG)											
	OAT											
	°C	-40	14	18	22	24	26	28	30	42	46	50
	°F	-40	57	64	72	75	79	82	86	108	115	122
1400	57.8	52.3	52.0	51.6	51.4	51.0	50.6	50.2	46.8	45.6	44.5	
1600	62.4	56.5	56.1	55.7	55.5	55.1	54.7	54.1	50.5	49.2	48.1	
1800	66.6	60.3	59.9	59.5	59.3	58.8	58.3	57.8	53.9	52.5	51.3	
2000	70.5	63.8	63.4	62.9	62.7	62.2	61.7	61.1	57.0	55.6	54.3	
2200	74.1	67.1	66.6	66.2	65.9	65.4	64.9	64.3	59.9	58.4	57.0	
2400	77.6	70.2	69.7	69.2	69.0	68.4	67.8	67.2	62.6	61.0	59.5	
2600	80.8	73.1	72.6	72.1	71.8	71.2	70.6	70.0	65.1	63.5	61.9	
2800	83.9	75.8	75.3	74.8	74.5	73.9	73.3	72.6	67.5	65.8	64.2	
3000	86.2	78.2	77.6	77.1	76.8	76.2	75.6	74.9	69.6	67.9	66.2	
3200	86.2	80.5	79.9	79.4	79.1	78.5	77.8	77.1	71.7	69.8	68.1	
3400	86.2	82.8	82.2	81.6	81.3	80.7	80.0	79.2	73.6	71.7	70.0	
3600	86.2	84.9	84.3	83.7	83.4	82.8	82.0	81.3	75.5	73.6	71.8	
3800	86.2	86.2	86.2	85.7	85.4	84.8	84.0	83.2	77.3	75.4	73.5	
4000	86.2	86.2	86.2	86.2	86.2	86.2	85.9	85.1	79.1	77.1	75.2	
4200	86.2	86.2	86.2	86.2	86.2	86.2	86.2	86.2	80.8	78.7	76.8	
4400	86.2	86.2	86.2	86.2	86.2	86.2	86.2	86.2	82.5	80.4	78.4	
4600	86.2	86.2	86.2	86.2	86.2	86.2	86.2	86.2	84.2	82.0	79.9	
CLIMB LIMIT WT (1000 KG)	76.2	75.7	75.6	75.5	75.5	74.8	74.1	73.2	66.4	64.2	62.0	

With engine bleed for packs off, increase field limit weight by 350 kg and climb limit weight by 1250 kg.
 With engine anti-ice on, decrease field limit weight by 150 kg and climb limit weight by 200 kg.
 With engine and wing anti-ice on (optional system), decrease field limit weight by 750 kg and climb limit weight by 1350 kg.

Takeoff Obstacle Limit Weight

Flaps 5

Sea Level 30°C & Below, Zero Wind

Based on engine bleed for packs on and anti-ice off

Reference Obstacle Limit Weight (1000 KG)

OBSTACLE HEIGHT (M)	DISTANCE FROM BRAKE RELEASE (100 M)											
	25	30	35	40	45	50	55	60	65	70	75	
5	73.4	79.2	83.0									
20	67.2	72.8	77.1	80.3	82.5	84.1						
40	62.2	67.4	71.6	75.0	77.7	79.8	81.4	82.7	83.7	84.6	85.3	
60	58.4	63.4	67.6	70.9	73.7	76.0	77.9	79.5	80.8	81.8	82.7	
80	55.1	60.1	64.2	67.6	70.5	72.8	74.9	76.6	78.0	79.2	80.3	
100	52.4	57.3	61.4	64.8	67.6	70.1	72.2	74.0	75.5	76.9	78.1	
120	49.9	54.8	58.9	62.3	65.1	67.6	69.8	71.7	73.3	74.7	76.0	
140	47.7	52.6	56.6	60.0	62.9	65.4	67.6	69.5	71.2	72.7	74.0	
160	45.7	50.6	54.6	58.0	60.9	63.4	65.6	67.6	69.3	70.9	72.2	
180	43.9	48.7	52.7	56.1	59.0	61.6	63.8	65.8	67.6	69.2	70.6	
200	42.3	47.0	51.0	54.4	57.3	59.9	62.1	64.1	65.9	67.5	69.0	
220		45.4	49.4	52.8	55.7	58.3	60.6	62.6	64.4	66.0	67.5	
240		44.0	47.9	51.3	54.2	56.8	59.1	61.1	63.0	64.6	66.1	
260		42.6	46.5	49.9	52.8	55.4	57.7	59.8	61.6	63.3	64.8	
280			45.2	48.6	51.5	54.1	56.4	58.4	60.3	62.0	63.5	
300			44.0	47.3	50.2	52.8	55.1	57.2	59.1	60.8	62.3	

When using line-up allowances, the obstacle distance from brake release must be reduced by the ASDA adjustment.

Obstacle height must be calculated from lowest point of the runway to conservatively account for runway slope.

OAT Adjustments

OAT (°C)	REFERENCE OBSTACLE LIMIT WEIGHT (1000 KG)					
	40	50	60	70	80	90
30 & BELOW	0	0	0	0	0	0
32	-0.6	-0.7	-0.9	-1.1	-1.3	-1.4
34	-1.1	-1.5	-1.8	-2.2	-2.5	-2.9
36	-1.7	-2.2	-2.7	-3.3	-3.8	-4.3
38	-2.2	-2.9	-3.6	-4.3	-5.0	-5.7
40	-2.8	-3.6	-4.5	-5.4	-6.2	-7.1
42	-3.3	-4.3	-5.4	-6.4	-7.4	-8.5
44	-3.8	-5.0	-6.2	-7.4	-8.6	-9.8
46	-4.4	-5.7	-7.1	-8.5	-9.8	-11.2
48	-4.9	-6.4	-8.0	-9.5	-11.0	-12.6
50	-5.4	-7.1	-8.8	-10.5	-12.2	-13.9

Pressure Altitude Adjustments

ALT (FT)	OAT ADJUSTED OBSTACLE LIMIT WEIGHT (1000 KG)					
	40	50	60	70	80	90
S.L. & BELOW	0	0	0	0	0	0
1000	-1.5	-1.8	-2.2	-2.5	-2.9	-3.2
2000	-3.0	-3.7	-4.3	-4.9	-5.5	-6.1
3000	-4.1	-5.1	-6.2	-7.3	-8.3	-9.4

Takeoff Obstacle Limit Weight

Flaps 5

Sea Level 30°C & Below, Zero Wind

Based on engine bleed for packs on and anti-ice off

Wind Adjustments

WIND (KTS)	OAT & ALT ADJUSTED OBSTACLE LIMIT WEIGHT (1000 KG)					
	40	50	60	70	80	90
15 T W	-6.0	-6.2	-6.4	-6.6	-6.9	-7.1
10 T W	-4.0	-4.1	-4.3	-4.4	-4.6	-4.7
5 T W	-2.0	-2.1	-2.1	-2.2	-2.3	-2.4
0	0	0	0	0	0	0
10 H W	1.3	1.1	1.0	0.8	0.6	0.5
20 H W	2.6	2.2	1.9	1.6	1.2	0.9
30 H W	3.9	3.4	2.9	2.4	1.9	1.4
40 H W	5.2	4.6	3.9	3.2	2.5	1.8

With engine bleed for packs off, increase weight by 550 kg.

With engine anti-ice on, decrease weight by 250 kg.

With engine and wing anti-ice on, decrease weight by 1300 kg (optional system).



Performance Dispatch

Chapter PD

Enroute

Section 31

Long Range Cruise Maximum Operating Altitude

Max Cruise Thrust

ISA + 10°C and Below

WEIGHT (1000 KG)	OPTIMUM ALT (FT)	TAT (°C)	MARGIN TO INITIAL BUFFET 'G' (BANK ANGLE)				
			1.20 (33°)	1.25 (36°)	1.30 (39°)	1.40 (44°)	1.50 (48°)
85	30300	-5	32800*	32800*	32700	31200	29800
80	31600	-8	34400*	34400*	34000	32500	31100
75	33000	-11	35900*	35900*	35400	33900	32500
70	34500	-15	37300*	37300*	36800	35300	34000
65	36000	-18	38700*	38700*	38300	36900	35500
60	37700	-18	40200*	40200*	40000	38500	37200
55	39500	-18	41000	41000	41000	40300	39000
50	41000	-18	41000	41000	41000	41000	41000
45	41000	-18	41000	41000	41000	41000	41000
40	41000	-18	41000	41000	41000	41000	41000

ISA + 15°C

WEIGHT (1000 KG)	OPTIMUM ALT (FT)	TAT (°C)	MARGIN TO INITIAL BUFFET 'G' (BANK ANGLE)				
			1.20 (33°)	1.25 (36°)	1.30 (39°)	1.40 (44°)	1.50 (48°)
85	30300	0	30600*	30600*	30600*	30600*	29800
80	31600	-3	32900*	32900*	32900*	32500	31100
75	33000	-6	34800*	34800*	34800*	33900	32500
70	34500	-9	36300*	36300*	36300*	35300	34000
65	36000	-13	37800*	37800*	37800*	36900	35500
60	37700	-13	39200*	39200*	39200*	38500	37200
55	39500	-13	40800*	40800*	40800*	40300	39000
50	41000	-13	41000	41000	41000	41000	41000
45	41000	-13	41000	41000	41000	41000	41000
40	41000	-13	41000	41000	41000	41000	41000

ISA + 20°C

WEIGHT (1000 KG)	OPTIMUM ALT (FT)	TAT (°C)	MARGIN TO INITIAL BUFFET 'G' (BANK ANGLE)				
			1.20 (33°)	1.25 (36°)	1.30 (39°)	1.40 (44°)	1.50 (48°)
85	30300	6	27500*	27500*	27500*	27500*	27500*
80	31600	3	30000*	30000*	30000*	30000*	30000*
75	33000	0	32800*	32800*	32800*	32800*	32500
70	34500	-3	34900*	34900*	34900*	34900*	34000
65	36000	-7	36500*	36500*	36500*	36500*	35500
60	37700	-7	38000*	38000*	38000*	38000*	37200
55	39500	-7	39500*	39500*	39500*	39500*	39000
50	41000	-7	41000	41000	41000	41000	41000
45	41000	-7	41000	41000	41000	41000	41000
40	41000	-7	41000	41000	41000	41000	41000

*Denotes altitude thrust limited in level flight, 100 fpm residual rate of climb.

Long Range Cruise Trip Fuel and Time
Ground to Air Miles Conversion

AIR DISTANCE (NM)					GROUND DISTANCE (NM)	AIR DISTANCE (NM)				
HEADWIND COMPONENT (KTS)						TAILWIND COMPONENT (KTS)				
100	80	60	40	20	20	40	60	80	100	
279	259	241	226	212	200	190	181	173	166	160
554	515	480	450	424	400	382	365	349	335	322
829	771	720	675	636	600	573	548	525	504	485
1103	1027	958	899	847	800	764	732	701	673	648
1376	1282	1197	1123	1059	1000	956	915	877	843	811
1649	1536	1435	1348	1270	1200	1147	1098	1053	1012	974
1921	1791	1673	1571	1482	1400	1339	1282	1229	1181	1138
2192	2044	1911	1795	1693	1600	1530	1465	1405	1351	1301
2463	2297	2148	2019	1904	1800	1721	1648	1581	1520	1465
2733	2550	2386	2242	2115	2000	1913	1832	1758	1690	1628
3003	2803	2622	2465	2326	2200	2105	2016	1934	1859	1791
3272	3054	2859	2688	2537	2400	2296	2200	2111	2029	1955
3540	3306	3095	2911	2748	2600	2488	2384	2287	2199	2119
3807	3556	3330	3133	2959	2800	2680	2568	2464	2369	2282
4074	3807	3566	3356	3169	3000	2871	2752	2641	2539	2446
4340	4057	3801	3578	3380	3200	3063	2935	2817	2709	2610
4606	4306	4036	3800	3590	3400	3255	3119	2994	2879	2774
4870	4555	4270	4021	3801	3600	3446	3303	3171	3049	2938
5134	4803	4504	4243	4011	3800	3638	3487	3347	3219	3102
5397	5051	4738	4464	4221	4000	3830	3671	3524	3389	3266
5659	5298	4971	4685	4431	4200	4021	3855	3701	3559	3430
5920	5544	5204	4906	4641	4400	4213	4038	3877	3729	3594
6181	5790	5437	5127	4851	4600	4404	4222	4054	3899	3758
6440	6035	5669	5347	5061	4800	4596	4406	4230	4069	3921
6699	6280	5901	5568	5271	5000	4787	4589	4406	4238	4085

Long Range Cruise Trip Fuel and Time
Reference Fuel and Time Required

AIR DIST (NM)	PRESSURE ALTITUDE (1000 FT)									
	29		31		33		35		37	
	FUEL (1000 KG)	TIME (HR:MIN)	FUEL (1000 KG)	TIME (HR:MIN)	FUEL (1000 KG)	TIME (HR:MIN)	FUEL (1000 KG)	TIME (HR:MIN)	FUEL (1000 KG)	TIME (HR:MIN)
200	1.5	0:38	1.5	0:37	1.5	0:37	1.5	0:36	1.5	0:36
400	2.5	1:09	2.5	1:08	2.4	1:06	2.4	1:05	2.4	1:04
600	3.5	1:40	3.5	1:38	3.4	1:36	3.4	1:33	3.3	1:31
800	4.6	2:11	4.5	2:09	4.4	2:05	4.3	2:01	4.3	1:58
1000	5.7	2:42	5.5	2:39	5.4	2:34	5.3	2:29	5.2	2:25
1200	6.8	3:12	6.6	3:08	6.5	3:02	6.3	2:56	6.2	2:52
1400	7.9	3:42	7.7	3:37	7.5	3:30	7.3	3:23	7.2	3:19
1600	9.0	4:12	8.7	4:06	8.5	3:58	8.3	3:51	8.2	3:46
1800	10.1	4:42	9.8	4:35	9.6	4:26	9.3	4:18	9.1	4:13
2000	11.2	5:11	10.9	5:04	10.6	4:55	10.3	4:45	10.1	4:40
2200	12.3	5:40	12.0	5:32	11.7	5:22	11.4	5:12	11.2	5:07
2400	13.5	6:09	13.1	5:59	12.8	5:49	12.5	5:39	12.2	5:34
2600	14.7	6:38	14.3	6:27	13.9	6:17	13.5	6:06	13.3	6:00
2800	15.8	7:06	15.4	6:55	15.0	6:44	14.6	6:33	14.3	6:27
3000	17.0	7:35	16.5	7:23	16.1	7:11	15.6	7:00	15.4	6:54
3200	18.2	8:03	17.7	7:49	17.2	7:38	16.8	7:26	16.5	7:20
3400	19.4	8:30	18.9	8:16	18.4	8:05	17.9	7:53	17.6	7:47
3600	20.7	8:58	20.1	8:43	19.5	8:31	19.0	8:20	18.8	8:13
3800	21.9	9:26	21.3	9:10	20.7	8:58	20.2	8:46	19.9	8:39
4000	23.1	9:53	22.5	9:37	21.8	9:25	21.3	9:13	21.0	9:06
4200	24.4	10:20	23.7	10:03	23.0	9:51	22.5	9:39		
4400	25.7	10:47	25.0	10:30	24.3	10:18	23.7	10:05		
4600	27.0	11:14	26.2	10:56	25.5	10:44	24.9	10:32		
4800	28.3	11:41	27.5	11:23	26.7	11:10	26.2	10:58		
5000	29.5	12:08	28.7	11:49	27.9	11:37	27.4	11:24		

Fuel Required Adjustments (1000 KG)

REFERENCE FUEL REQUIRED (1000 KG)	LANDING WEIGHT (1000 KG)						
	40	45	50	55	60	65	70
2	-0.2	-0.1	0.0	0.1	0.2	0.4	0.5
4	-0.4	-0.2	0.0	0.2	0.5	0.8	1.2
6	-0.5	-0.3	0.0	0.3	0.8	1.4	2.0
8	-0.7	-0.4	0.0	0.5	1.1	2.0	3.0
10	-0.9	-0.5	0.0	0.6	1.5	2.6	4.0
12	-1.1	-0.5	0.0	0.7	1.8	3.3	5.2
14	-1.2	-0.6	0.0	0.8	2.2	4.1	6.5
16	-1.4	-0.7	0.0	1.0	2.6	4.9	7.9
18	-1.6	-0.8	0.0	1.1	3.1	5.9	9.5
20	-1.8	-0.9	0.0	1.3	3.5	6.8	11.1
22	-2.0	-1.0	0.0	1.4	4.0	7.9	12.9
24	-2.2	-1.1	0.0	1.6	4.5	9.0	14.8
26	-2.4	-1.2	0.0	1.7	5.1	10.1	16.8
28	-2.6	-1.3	0.0	1.9	5.7	11.3	18.9
30	-2.8	-1.4	0.0	2.0	6.3	12.6	21.2
32	-3.0	-1.5	0.0	2.2	6.9	14.0	23.5

Based on 280/.78 climb, Long Range Cruise and .78/280/250 descent.

Long Range Cruise Step Climb Ground to Air Miles Conversion

AIR DISTANCE (NM)					GROUND DISTANCE (NM)	AIR DISTANCE (NM)				
HEADWIND COMPONENT (KTS)						TAILWIND COMPONENT (KTS)				
100	80	60	40	20		20	40	60	80	100
1316	1237	1168	1106	1050	1000	954	912	874	839	807
1830	1724	1630	1545	1469	1400	1337	1280	1227	1179	1134
2343	2210	2091	1984	1888	1800	1720	1647	1580	1518	1461
2856	2695	2552	2423	2306	2200	2103	2015	1933	1858	1789
3369	3181	3013	2861	2724	2600	2486	2382	2287	2198	2117
3882	3666	3474	3300	3143	3000	2870	2750	2640	2539	2445
4395	4152	3934	3738	3561	3400	3253	3118	2993	2879	2772
4907	4637	4395	4177	3980	3800	3636	3485	3347	3219	3100
5420	5123	4856	4616	4398	4200	4019	3853	3700	3559	3428
5933	5608	5317	5054	4816	4600	4402	4221	4054	3899	3756
6447	6094	5778	5493	5235	5000	4785	4588	4407	4239	4084

Trip Fuel and Time Required

AIR DIST (NM)	TRIP FUEL (1000 KG)							TIME (HRS:MIN)
	LANDING WEIGHT (1000 KG)							
	40	45	50	55	60	65	70	
1000	4.5	4.8	5.2	5.6	5.9	6.4	6.7	2:24
1400	6.2	6.5	7.1	7.7	8.2	8.8	9.2	3:17
1800	7.8	8.3	9.1	9.8	10.5	11.2	11.9	4:10
2200	9.5	10.2	11.1	12.0	12.8	13.7	14.6	5:03
2600	11.3	12.1	13.2	14.2	15.3	16.3	17.4	5:56
3000	13.0	14.1	15.3	16.6	17.8	19.0	20.2	6:49
3400	14.9	16.1	17.5	19.0	20.3	21.8	23.2	7:42
3800	16.8	18.2	19.8	21.4	23.0	24.6	26.2	8:34
4200	18.8	20.4	22.2	24.0	25.7	27.6		9:27
4600	20.8	22.6	24.6	26.6	28.6	30.6		10:20
5000	22.9	24.9	27.0	29.3	31.5	33.7		11:13

Based on 280/.78 climb, Long Range Cruise or .78 and .78/280/250 descent.

Valid for all pressure altitudes with 4000 ft step climb to 2000 ft above optimum altitude.

**Short Trip Fuel and Time
 Ground to Air Miles Conversion**

AIR DISTANCE (NM)					GROUND DISTANCE (NM)	AIR DISTANCE (NM)				
HEADWIND COMPONENT (KTS)						TAILWIND COMPONENT (KTS)				
100	80	60	40	20		20	40	60	80	100
93	80	69	61	55	50	46	42	39	36	34
160	143	129	118	108	100	93	87	82	77	73
225	205	188	173	161	150	141	132	125	118	112
290	266	246	228	213	200	188	178	169	160	153
353	326	303	283	265	250	236	224	213	203	194
416	386	360	338	318	300	284	270	257	245	235
478	446	417	392	370	350	332	316	301	288	276
542	506	474	447	422	400	380	362	346	331	317
606	567	532	502	474	450	428	408	390	373	358
672	629	591	557	527	500	476	454	434	415	398

Trip Fuel and Time Required

AIR DIST (NM)		LANDING WEIGHT (1000 KG)							TIME (HRS:MIN)
		40	45	50	55	60	65	70	
50	FUEL (1000 KG)	0.5	0.5	0.6	0.6	0.7	0.7	0.7	0:14
	ALT (FT)	12000	12000	11000	11000	9000	9000	8000	
100	FUEL (1000 KG)	0.8	0.9	0.9	1.0	1.0	1.1	1.1	0:22
	ALT (FT)	19000	18000	18000	18000	17000	17000	17000	
150	FUEL (1000 KG)	1.1	1.1	1.2	1.3	1.3	1.4	1.5	0:30
	ALT (FT)	26000	25000	25000	24000	23000	22000	22000	
200	FUEL (1000 KG)	1.3	1.4	1.5	1.6	1.6	1.7	1.8	0:37
	ALT (FT)	35000	30000	28000	27000	26000	26000	26000	
250	FUEL (1000 KG)	1.5	1.6	1.7	1.8	1.9	2.0	2.1	0:44
	ALT (FT)	40000	37000	36000	35000	34000	31000	30000	
300	FUEL (1000 KG)	1.7	1.8	1.9	2.1	2.2	2.3	2.4	0:50
	ALT (FT)	41000	40000	39000	37000	35000	34000	32000	
350	FUEL (1000 KG)	1.9	2.0	2.2	2.3	2.4	2.6	2.7	0:56
	ALT (FT)	41000	40000	40000	38000	36000	35000	33000	
400	FUEL (1000 KG)	2.1	2.2	2.4	2.5	2.7	2.9	3.0	1:03
	ALT (FT)	41000	40000	40000	38000	36000	35000	33000	
450	FUEL (1000 KG)	2.3	2.5	2.6	2.8	3.0	3.1	3.3	1:10
	ALT (FT)	41000	41000	40000	38000	36000	35000	34000	
500	FUEL (1000 KG)	2.5	2.7	2.8	3.0	3.2	3.4	3.6	1:17
	ALT (FT)	41000	41000	40000	38000	36000	35000	34000	

Based on 280/.78 climb, Long Range Cruise and .78/280/250 descent.

**Holding Planning
 Flaps Up**

WEIGHT (1000 KG)	TOTAL FUEL FLOW (KG/HR)								
	PRESSURE ALTITUDE (FT)								
	1500	5000	10000	15000	20000	25000	30000	35000	41000
85	3080	3030	3020	2990	2970	2980	3080		
80	2910	2870	2840	2830	2780	2790	2860	3130	
75	2750	2700	2670	2650	2600	2600	2660	2800	
70	2590	2540	2500	2480	2430	2420	2470	2550	
65	2420	2370	2340	2310	2270	2230	2280	2330	
60	2260	2210	2180	2140	2110	2050	2090	2130	
55	2100	2050	2010	1980	1940	1890	1910	1940	2110
50	1950	1890	1850	1810	1780	1730	1750	1770	1890
45	1790	1730	1690	1680	1640	1610	1590	1590	1670
40	1670	1620	1560	1520	1480	1450	1440	1420	1480

This table includes 5% additional fuel for holding in a racetrack pattern.

Flight Crew Oxygen Requirements

Required Pressure (PSI) for 76 Cu. Ft. Cylinder

BOTTLE TEMPERATURE		NUMBER OF CREW USING OXYGEN		
°C	°F	2	3	4
50	122	735	1055	1360
45	113	725	1040	1340
40	104	715	1020	1320
35	95	700	1005	1300
30	86	690	990	1280
25	77	680	975	1255
20	68	670	960	1240
15	59	655	940	1215
10	50	645	925	1195
5	41	635	910	1175
0	32	620	890	1150
-5	23	610	875	1130
-10	14	600	860	1110

Required Pressure (PSI) for 114/115 Cu. Ft. Cylinder

BOTTLE TEMPERATURE		NUMBER OF CREW USING OXYGEN		
°C	°F	2	3	4
50	122	530	735	945
45	113	520	725	930
40	104	510	715	915
35	95	505	700	900
30	86	495	690	885
25	77	485	680	870
20	68	480	670	860
15	59	470	655	840
10	50	460	645	830
5	41	455	635	815
0	32	445	620	800
-5	23	440	610	785
-10	14	430	600	770

ENGINE INOP

MAX CONTINUOUS THRUST

Net Level Off Weight

PRESSURE ALTITUDE (1000 FT)	LEVEL OFF WEIGHT (1000 KG)		
	ISA + 10°C & BELOW	ISA + 15°C	ISA + 20°C
30	42.5	41.3	
28	46.3	44.9	43.5
26	50.3	48.8	47.3
24	54.7	52.9	51.3
22	59.4	57.4	55.5
20	64.4	62.2	60.1
18	69.4	66.9	64.4
16	74.2	71.8	69.4
14	78.1	76.3	74.3
12	83.4	81.1	78.2
10	86.1	85.4	81.8

Anti-Ice Adjustments

ANTI-ICE CONFIGURATION	LEVEL OFF WEIGHT ADJUSTMENT (1000 KG)										
	PRESSURE ALTITUDE (1000 FT)										
	10	12	14	16	18	20	22	24	26	28	30
ENGINE ONLY		-2.9	-2.5	-1.7	-1.6	-1.5	-1.4	-1.3	-1.2	-1.1	
ENGINE AND WING	-5.3	-7.8	-6.4	-6.6	-6.3	-5.8	-5.5	-5.1	-4.7	-4.4	

ALL ENGINES

Long Range Cruise Critical Fuel Reserves Ground to Air Miles Conversion

AIR DISTANCE (NM)					GROUND DISTANCE (NM)	AIR DISTANCE (NM)				
HEADWIND COMPONENT (KTS)						TAILWIND COMPONENT (KTS)				
100	80	60	40	20	20	40	60	80	100	
287	264	245	228	213	200	189	178	169	161	153
585	535	494	458	427	400	376	355	336	319	304
882	806	742	688	641	600	564	532	503	478	455
1180	1077	991	918	855	800	752	709	671	636	605
1477	1348	1240	1148	1069	1000	939	886	838	795	756
1774	1619	1489	1379	1283	1200	1127	1062	1005	953	907
2072	1890	1738	1609	1497	1400	1315	1239	1172	1112	1057
2369	2161	1987	1839	1711	1600	1502	1416	1339	1270	1208
2667	2432	2236	2069	1925	1800	1690	1593	1506	1429	1358

Critical Fuel (1000 KG)

AIR DIST (NM)	WEIGHT AT CRITICAL POINT (1000 KG)									
	45	50	55	60	65	70	75	80	85	
200	1.8	1.9	2.0	2.1	2.1	2.2	2.3	2.4	2.4	
300	2.6	2.7	2.8	2.9	3.0	3.1	3.2	3.3	3.4	
400	3.4	3.5	3.6	3.7	3.9	4.0	4.1	4.3	4.4	
500	4.1	4.3	4.4	4.6	4.7	4.9	5.0	5.2	5.4	
600	4.9	5.1	5.2	5.4	5.6	5.8	6.0	6.2	6.3	
700	5.6	5.8	6.0	6.2	6.4	6.6	6.8	7.1	7.3	
800	6.4	6.6	6.8	7.0	7.3	7.5	7.7	8.0	8.2	
900	7.2	7.4	7.6	7.9	8.1	8.4	8.6	8.9	9.2	
1000	7.9	8.1	8.4	8.7	8.9	9.2	9.5	9.8	10.1	
1100	8.7	8.9	9.2	9.5	9.8	10.1	10.4	10.7	11.1	
1200	9.4	9.6	10.0	10.3	10.6	10.9	11.3	11.6	12.0	
1300	10.2	10.4	10.7	11.1	11.4	11.8	12.1	12.5	12.9	
1400	10.9	11.1	11.5	11.9	12.2	12.6	13.0	13.4	13.8	
1500	11.7	11.9	12.3	12.7	13.1	13.5	13.9	14.3	14.7	
1600	12.5	12.7	13.0	13.4	13.9	14.3	14.7	15.2	15.7	
1700	13.2	13.4	13.8	14.2	14.7	15.1	15.6	16.1	16.6	
1800	14.0	14.2	14.5	15.0	15.5	16.0	16.4	16.9	17.5	

Based on: Emergency descent to 10000 ft. Level cruise at 10000 ft. 250 KIAS descent to 1500 ft. 15 minutes hold at 1500 ft. One missed approach; approach and land. 5% allowance for wind errors.

Increase fuel required 0.5% for each 10°C hotter than ISA conditions.

If icing conditions exist, increase fuel by 15% to account for engine and wing anti-ice on (7%) and ice accumulation on unheated surfaces (8%).

Allowance for performance deterioration not included.

Compare the fuel required from this chart with critical fuel reserves for one engine inoperative.

Use the higher of the two.

ENGINE INOP

MAX CONTINUOUS THRUST

Long Range Cruise Critical Fuel Reserves Ground to Air Miles Conversion

AIR DISTANCE (NM)					GROUND DISTANCE (NM)	AIR DISTANCE (NM)				
HEADWIND COMPONENT (KTS)						TAILWIND COMPONENT (KTS)				
100	80	60	40	20		20	40	60	80	100
292	267	246	229	213	200	188	178	168	160	152
595	542	498	460	428	400	375	354	334	317	301
898	817	749	692	643	600	563	530	500	474	451
1201	1092	1000	923	857	800	750	706	666	631	600
1504	1366	1252	1155	1072	1000	937	882	833	789	749
1808	1641	1503	1386	1286	1200	1124	1058	999	946	898
2111	1916	1754	1618	1501	1400	1312	1234	1165	1103	1047
2414	2191	2006	1849	1716	1600	1499	1410	1331	1260	1197
2717	2466	2257	2081	1930	1800	1686	1586	1497	1417	1346

Critical Fuel (1000 KG)

AIR DIST (NM)	WEIGHT AT CRITICAL POINT (1000 KG)								
	45	50	55	60	65	70	75	80	85
200	1.7	1.7	1.8	1.9	2.0	2.1	2.1	2.2	2.3
300	2.3	2.4	2.5	2.7	2.8	2.9	3.0	3.1	3.2
400	3.0	3.1	3.3	3.4	3.6	3.7	3.8	4.0	4.1
500	3.7	3.8	4.0	4.2	4.4	4.5	4.7	4.9	5.1
600	4.3	4.5	4.7	4.9	5.1	5.4	5.6	5.8	6.0
700	5.0	5.2	5.5	5.7	5.9	6.2	6.4	6.6	6.9
800	5.7	5.9	6.2	6.4	6.7	7.0	7.2	7.5	7.8
900	6.4	6.6	6.9	7.2	7.5	7.8	8.1	8.4	8.7
1000	7.0	7.3	7.6	7.9	8.2	8.6	8.9	9.2	9.6
1100	7.7	7.9	8.3	8.6	9.0	9.4	9.7	10.1	10.4
1200	8.4	8.6	9.0	9.4	9.8	10.2	10.5	10.9	11.3
1300	9.0	9.3	9.7	10.1	10.5	10.9	11.4	11.8	12.2
1400	9.7	10.0	10.4	10.8	11.3	11.7	12.2	12.6	13.0
1500	10.4	10.6	11.1	11.5	12.0	12.5	12.9	13.4	13.9
1600	11.1	11.3	11.7	12.2	12.7	13.2	13.7	14.3	14.8
1700	11.7	12.0	12.4	12.9	13.5	14.0	14.5	15.1	15.6
1800	12.4	12.6	13.1	13.6	14.2	14.8	15.3	15.9	16.5

Based on: Emergency descent to 10000 ft. Level cruise at 10000 ft. 250 KIAS descent to 1500 ft. 15 minutes hold at 1500 ft. One missed approach; approach and land. 5% allowance for wind errors.

Increase fuel required 0.5% for each 10°C hotter than ISA conditions.

If icing conditions exist, increase fuel by 15% to account for engine and wing anti-ice on (6%) and ice accumulation on unheated surfaces (9%).

Allowance for performance deterioration not included.

Compare the fuel required from this chart with critical fuel reserves for all engines operative.

Use the higher of the two.

Intentionally
Blank



Performance Dispatch
Landing

Chapter PD
Section 32

Landing Field Limit Weight
Flaps 40

Wind Corrected Field Length (M)

FIELD LENGTH AVAILABLE (M)	WIND COMPONENT (KTS)							
	-15	-10	-5	0	10	20	30	40
1000		810	900	1000	1060	1130	1200	1270
1200	900	1000	1100	1200	1270	1340	1420	1500
1400	1080	1180	1290	1400	1470	1560	1640	1720
1600	1250	1360	1480	1600	1680	1770	1850	1940
1800	1430	1550	1670	1800	1890	1980	2070	2170
2000	1610	1730	1860	2000	2090	2190	2290	2390
2200	1790	1920	2050	2200	2300	2400	2510	2620
2400	1970	2100	2250	2400	2510	2610	2720	
2600	2140	2290	2440	2600	2720			
2800	2320	2470	2630	2800				
3000	2500	2650						
3200	2680							

Field Limit Weight (1000 KG)

WIND CORR'D FIELD LENGTH (M)	AIRPORT PRESSURE ALTITUDE (FT)											
	0		2000		4000		6000		8000		10000	
	DRY	WET	DRY	WET	DRY	WET	DRY	WET	DRY	WET	DRY	WET
1000	36.0											
1200	46.0	38.2	43.4	36.0	40.9		38.5		36.2			
1400	55.7	46.9	52.9	44.2	49.9	41.7	47.1	39.2	44.3	36.9	41.6	
1600	63.7	55.4	60.8	52.5	58.1	49.5	55.4	46.7	52.4	43.9	49.3	41.3
1800	72.3	62.3	68.7	59.5	65.2	56.8	62.2	54.1	59.3	51.0	56.5	48.0
2000	81.3	69.6	77.1	66.1	73.2	63.0	69.4	60.2	65.8	57.4	62.6	54.7
2200	88.5	77.4	85.3	73.4	81.2	69.7	77.0	66.1	72.9	62.9	69.0	60.0
2400		85.0		80.8	87.8	76.7	84.5	72.7	80.1	68.8	75.7	65.2
2600		90.4		87.1		83.7	89.8	79.3	85.6	75.1	81.7	71.0
2800						88.8		85.5	88.4	81.3	84.8	76.8
3000								90.1		85.7	87.1	81.8
3200										88.2	89.4	84.6
3400										90.6		86.6
3600												88.6
3800												90.6

Decrease field limit weight 4300 kg when using manual speedbrakes.

Landing Climb Limit Weight

Valid for approach with Flaps 15 and landing with Flaps 40

Based on engine bleed for packs on and anti-ice off

AIRPORT OAT		LANDING CLIMB LIMIT WEIGHT (1000 KG)					
		AIRPORT PRESSURE ALTITUDE (FT)					
°C	°F	0	2000	4000	6000	8000	10000
50	122	66.4	61.4				
48	118	67.8	62.9				
46	115	69.0	64.4	59.4			
44	111	70.2	65.6	60.8			
42	108	71.5	66.8	62.2	57.1		
40	104	72.7	68.0	63.4	58.4		
38	100	74.0	69.1	64.5	59.7	54.4	
36	97	75.3	70.4	65.7	60.8	55.3	
34	93	76.7	71.7	66.9	61.9	56.3	51.5
32	90	78.1	72.9	68.0	62.9	57.3	52.7
30	86	79.4	74.0	68.8	63.8	58.3	53.7
28	82	79.5	75.0	69.6	64.6	59.2	54.5
26	79	79.5	75.9	70.3	65.2	60.1	55.5
24	75	79.6	75.9	70.9	65.7	60.9	56.0
22	72	79.7	76.0	71.4	66.1	61.3	56.6
20	68	79.7	76.0	71.4	66.7	61.7	57.1
18	64	79.8	76.1	71.5	67.1	62.1	57.3
16	61	79.9	76.1	71.5	67.1	62.5	57.8
14	57	79.9	76.2	71.6	67.2	62.9	58.1
12	54	80.0	76.2	71.6	67.2	62.9	58.4
10	50	80.0	76.3	71.6	67.2	62.9	58.8
-40	-40	80.6	76.8	72.1	67.7	63.3	59.3

With engine bleeds for packs off, increase weight by 1200 kg.

With engine anti-ice on, decrease weight by 300 kg.

With engine and wing anti-ice on, decrease weight by 1400 kg.

When operating in icing conditions during any part of the flight with forecast landing temperature below 10°C, decrease weight by 5500 kg.

ENGINE INOP

Go-Around Climb Gradient

Flaps 15

Based on engine bleed for packs on and anti-ice off

OAT (°C)	REFERENCE GO-AROUND GRADIENT (%)					
	PRESSURE ALTITUDE (FT)					
	0	2000	4000	6000	8000	10000
54	2.54					
50	3.21	2.15				
46	3.72	2.80	1.75			
42	4.23	3.27	2.35	1.29		
38	4.75	3.74	2.79	1.82	0.73	
34	5.27	4.25	3.26	2.25	1.11	0.19
30	5.82	4.71	3.65	2.62	1.52	0.60
26	5.85	5.07	3.94	2.90	1.87	0.94
22	5.88	5.09	4.16	3.09	2.11	1.16
18	5.90	5.11	4.17	3.27	2.27	1.33
14	5.92	5.12	4.18	3.28	2.41	1.47
10	5.95	5.14	4.20	3.29	2.42	1.61
6	5.97	5.16	4.21	3.30	2.44	1.62
2	5.99	5.17	4.22	3.31	2.45	1.63

Gradient Adjustment for Weight (%)

WEIGHT (1000 KG)	REFERENCE GO-AROUND GRADIENT (%)						
	0	1	2	3	4	5	6
80	-2.44	-2.78	-3.08	-3.35	-3.62	-3.88	-4.15
75	-1.98	-2.23	-2.47	-2.68	-2.90	-3.11	-3.32
70	-1.42	-1.60	-1.76	-1.92	-2.07	-2.23	-2.38
65	-0.76	-0.86	-0.95	-1.03	-1.12	-1.20	-1.28
60	0	0	0	0	0	0	0
55	0.90	1.00	1.10	1.21	1.31	1.41	1.52
50	2.01	2.23	2.45	2.67	2.90	3.13	3.37

Gradient Adjustment for Speed (%)

SPEED (KIAS)	WEIGHT ADJUSTED GO-AROUND GRADIENT (%)												
	0	1	2	3	4	5	6	7	8	9	10	11	12
VREF40	-0.25	-0.27	-0.29	-0.30	-0.31	-0.31	-0.30	-0.30	-0.30	-0.30	-0.29	-0.29	-0.27
VREF40+5	0	0	0	0	0	0	0	0	0	0	0	0	0
VREF40+10	0.15	0.14	0.14	0.14	0.13	0.12	0.12	0.12	0.12	0.13	0.13	0.13	0.11
VREF40+15	0.22	0.21	0.20	0.20	0.18	0.16	0.14	0.13	0.14	0.15	0.16	0.16	0.14
VREF40+20	0.24	0.22	0.21	0.19	0.17	0.13	0.10	0.09	0.09	0.10	0.11	0.09	0.05
VREF40+25	0.20	0.17	0.14	0.12	0.08	0.04	-0.01	-0.04	-0.04	-0.03	-0.03	-0.05	-0.11
VREF40+30	0.12	0.07	0.03	-0.02	-0.08	-0.14	-0.19	-0.22	-0.23	-0.23	-0.23	-0.25	-0.31

With engine bleed for packs off, increase gradient by 0.2%.

With engine anti-ice on, decrease gradient by 0.1%.

With engine and wing anti-ice on, decrease gradient by 0.3%.

When operating in icing conditions during any part of the flight with forecast landing temperatures below 10°C decrease gradient by 0.9%.

Quick Turnaround Limit Weight Flaps 40

AIRPORT OAT (°C)	LIMIT WEIGHT (1000 KG)					
	AIRPORT PRESSURE ALTITUDE (FT)					
	0	2000	4000	6000	8000	10000
54	79.6					
50	80.2	77.2				
45	80.9	77.8	74.8			
40	81.6	78.5	75.4	72.4		
35	82.3	79.2	76.1	73.1	70.1	
30	83.0	79.9	76.7	73.7	70.8	67.9
25	83.8	80.6	77.4	74.4	71.4	68.5
20	84.6	81.3	78.1	75.1	72.1	69.1
15	85.4	82.1	78.9	75.8	72.7	69.8
10	86.1	82.9	79.6	76.5	73.4	70.4
5	86.1	83.7	80.4	77.2	74.1	71.1
0	86.1	84.5	81.2	78.0	74.9	71.8
-5	86.1	85.4	82.0	78.8	75.6	72.5
-10	86.1	86.1	82.8	79.6	76.4	73.3
-15	86.1	86.1	83.7	80.4	77.2	74.0
-20	86.1	86.1	84.6	81.2	78.0	74.8
-30	86.1	86.1	86.1	83.0	79.7	76.4
-40	86.1	86.1	86.1	84.9	81.5	78.1
-50	86.1	86.1	86.1	86.1	83.4	79.9
-54	86.1	86.1	86.1	86.1	84.1	80.7

Increase weight by 700 kg per 1% uphill slope. Decrease weight by 1200 kg per 1% downhill slope.
Increase weight by 1850 kg per 10 knots headwind. Decrease weight by 7750 kg per 10 knots tailwind.

After landing at weights exceeding those shown above, adjusted for slope and wind, wait at least 67 minutes and check that wheel thermal plugs have not melted before executing a subsequent takeoff.

As an alternate procedure, ensure that each brake pressure plate surface temperature, without artificial cooling, is less than 218°C as follows: No sooner than 10 and no later than 15 minutes after parking, measure each brake pressure plate surface temperature at a minimum of two points per brake by an accurate method (using a Doric Microtemp 450 hand held thermometer or equivalent, hold temperature probe in place for 20 seconds or until reading stabilizes). If each measured temperature is less than 218°C, immediate dispatch is allowed; otherwise the required minimum ground wait period of 67 minutes applies.

If a Brake Temperature Monitoring System (BTMS) is installed:

No sooner than 10 and no later than 15 minutes after parking, check the BRAKE TEMP light. If the BRAKE TEMP light is not on, no ground waiting period is required. If the BRAKE TEMP light is on, do not dispatch until at least 67 minutes after landing, or until all the BTMS readings on the systems Display are below 3.5 and the BRAKE TEMP light is off. Check that wheel thermal plugs have not melted before making a subsequent takeoff.

Note: If any brake temperature display digit is blank or indicates 0.0 or 0.1, then this method cannot be used.

Performance Dispatch

Chapter PD

Text

Section 33

Introduction

This chapter contains self dispatch performance data intended primarily for use by flight crews in the event that information cannot be obtained from the airline dispatch office. The takeoff data provided is for a single takeoff flap at max takeoff thrust. The range of conditions covered is limited to those normally encountered in airline operation. In the event of conflict between the data presented in this chapter and that contained in the approved Airplane Flight Manual, the Flight Manual shall always take precedence.

Takeoff

The maximum allowable takeoff weight will be the least of the Field, Climb and Obstacle Limit Weights as determined from the tables shown. Tire and Brake Energy Limits are not shown as they are not limiting for the range of conditions shown in this chapter.

JAROPS-1 requires that the runway length be adjusted to account for alignment of the airplane prior to takeoff. The table below provides TORA, TODA and ASDA adjustments for both 90 degree taxiway entry and 180 degree turnaround. For the 180 degree turnaround case, adjustments are provided for both a nominal 60 m runway as well as the minimum required for the stated minimum pavement width. These values may be used when obtaining takeoff weights from the Airplane Flight Manual or a takeoff analysis program. When using line-up allowances with the Field Length Limit chart, the field length available must be reduced by the ASDA adjustment.

	90 DEGREE TAXIWAY ENTRY	180 DEGREE TURNAROUND	
	MINIMUM LINE-UP DISTANCE (M)	NOMINAL LINE-UP DISTANCE (M) (60.0 M RUNWAY)	MINIMUM LINE-UP DISTANCE (M) (30.0 M RUNWAY)
TORA & TODA	10.8	19.6	19.6
ASDA	26.4	35.2	35.2

Field Limit Weight - Slope and Wind Corrections

These tables for dry and wet runways provide corrections to the field length available for the effects of runway slope and wind component along the runway. Enter the appropriate table with the available field length and runway slope to determine the slope corrected field length. Next enter the appropriate table with slope corrected field length and wind component to determine the slope and wind corrected field length.

Field and Climb Limit Weight

Tables are presented for selected airport pressure altitudes and runway conditions and show both Field and Climb Limit Weights. Enter the appropriate table for pressure altitude and runway condition with “Slope and Wind Corrected Field Length” determined above and airport OAT to obtain Field Limit Weight. Also read Climb Limit Weight for the same OAT. Intermediate altitudes may be interpolated or use next higher altitude. When finding a maximum weight for a wet runway, the dry runway limit weight must also be determined and the lower of the two weights used.

Obstacle Limit Weight

The Reference Obstacle Limit Weight table provides obstacle limit weights for reference airport conditions based on obstacle height above the runway surface and distance from brake release. Enter the adjustment tables to adjust the reference Obstacle Limit Weight for the effects of OAT, pressure altitude and wind as indicated. In the case of multiple obstacles, enter the tables successively with each obstacle and determine the most limiting weight.

When using line-up allowances with the Obstacle Limit chart, the obstacle distance from brake release must be reduced by the ASDA adjustment.

Enroute

Long Range Cruise Maximum Operating Altitude

These tables provide the maximum operating altitude in the same manner as the FMC. Maximum altitudes are shown for a given cruise weight and maneuver capability. Note that this table considers both thrust and buffet limits, providing the more limiting of the two. Any data that is thrust limited is denoted by an asterisk and represents only a thrust limited condition in level flight with 100 ft/min residual rate of climb. Flying above these altitudes with sustained banks in excess of approximately 15° may cause the airplane to lose speed and/or altitude. The altitudes shown in the table are limited to the maximum certified altitude of 41000 ft.

Long Range Cruise Trip Fuel and Time

Long Range Cruise Trip Fuel and Time tables are provided to determine trip time and fuel required to destination.

To determine trip fuel and time for a constant altitude cruise, first enter the Ground to Air Miles Conversion table to convert ground distance and enroute wind to an equivalent still air distance for use with the Reference Fuel and Time tables. Next, enter the Reference Fuel and Time table with

air distance from the Ground to Air Miles Conversion table and the desired altitude and read Reference Fuel and Time Required. Lastly, enter the Fuel Required Adjustment table with the Reference Fuel and the planned landing weight to obtain the adjustment to the fuel required at the planned landing weight.

Long Range Cruise Step Climb Trip Fuel and Time

The Long Range Cruise Step Climb Trip Fuel and Time tables are provided to determine trip time and fuel required to destination when flying a step climb profile. Step climb profiles are based on 4000 ft step climbs to keep the flight within 2000 ft of the optimum altitude for the current cruise weight. To determine trip fuel and time, enter the Ground to Air Miles Conversion table and determine air distance as discussed above. Then enter the Trip Fuel and Time Required table with air distance and planned landing weight to read trip fuel. Continue across the table to read trip time.

Short Trip Fuel and Time

These tables are provided to determine trip fuel and time for short distances or alternates. Obtain air distance from the table using the ground distance and wind component to the alternate. Enter the Trip Fuel and Time Required table with air distance and read trip fuel required for the expected landing weight, together with time to alternate at right. For distances greater than shown or other altitudes, use the Long Range Cruise Trip Fuel and Time tables.

Holding Planning

This table provides total fuel flow information necessary for planning flaps up holding and reserve fuel requirements. Data is based on the FMC holding speed schedule which is the higher of the maximum endurance and flaps up maneuver speeds. As noted, the fuel flow is based on flight in a racetrack holding pattern. For holding in straight and level flight, reduce table values by 5%.

Flight Crew Oxygen Requirements

Regulations require that sufficient oxygen be provided to the flight crew to account for the greater of supplemental breathing oxygen in the event of a cabin depressurization or protective breathing in the event of smoke or harmful fumes in the flight deck. The oxygen quantity associated with the above requirements is achieved with the minimum dispatch oxygen cylinder pressure.

To determine the minimum dispatch oxygen cylinder pressure enter the appropriate flight crew oxygen table with the number of crew plus observers using oxygen and read the minimum cylinder pressure required for the appropriate cylinder temperature.

Net Level Off Weight

The Net Level Off Weight table is provided to determine terrain clearance capability in straight and level flight following an engine failure. Regulations require terrain clearance planning based on net performance which is the gross (or actual) gradient performance degraded by 1.1%. In addition, the net level off pressure altitude must clear the terrain by 1000 ft.

To determine the maximum weight for terrain clearance, enter the table with required net level off pressure altitude and expected ISA deviation to obtain weight. Adjust weight for anti-ice operation as noted below the table.

Extended Range Operations

Regulations require that flights conducted over a route that contains a point further than one hour's time at "normal one engine inoperative speed" from an adequate diversion airport comply with rules set up specifically for "Extended Range Operation with Two Engine airplanes." This section provides reserve fuel planning information for the "Critical Fuel Scenario" based on two engine operation at Long Range Cruise as well as single engine operation at Long Range Cruise.

Long Range Cruise Critical Fuel Reserves

Enter the Ground to Air Miles Conversion table with forecast wind and ground distance to diversion airport from critical point to obtain air distance. Now enter the Critical Fuel table with air distance and expected weight at the critical point and read required fuel. Apply the noted fuel adjustments as necessary. Regulations require a 5% allowance for performance deterioration unless a value has been established by the operator for inservice deterioration.

As noted below each table, the fuel required is the greater of the two engine fuel and the single engine fuel. This fuel is compared to the amount of fuel normally onboard the airplane at that point in the route. If the fuel required by the critical fuel reserves exceeds the amount of fuel normally expected, the fuel load must be adjusted accordingly.

Landing

Tables are provided for determining the maximum landing weight as limited by field length or climb requirements for a single landing flap.

Maximum landing weight is the lowest of the field length limit weight, climb limit weight, or maximum certified landing weight.

Landing Field Limit Weight

Obtain wind corrected field length by entering the Wind Corrected Field Length table with field length available and wind component along the runway. Now enter the Field Limit Weight table with wind corrected field length and pressure altitude to read field limit weight for the expected runway condition.

Landing Climb Limit Weight

Enter the table with airport OAT and pressure altitude to read landing climb limit weight. Apply the noted adjustments as required.

Go-Around Climb Gradient

Enter the Reference Go-Around Gradient table with airport OAT and pressure altitude to determine the reference go-around gradient. Then adjust the reference gradient for airplane weight and speed using the tables provided to determine the weight and speed adjusted go-around gradient. Apply the necessary corrections for engine bleed configuration and icing conditions as noted.

Quick Turnaround Limit Weight

Enter the table with airport pressure altitude and OAT to read maximum quick turnaround weight. Apply the noted adjustments as required.

If the landing weight exceeds the maximum quick turnaround weight, wait the specified time and then check that the wheel thermal plugs have not melted before executing a subsequent takeoff, or ensure the brake temperature is within limits using the alternate procedure described on the page.

Intentionally
Blank



**Airplane General, Emergency
Equipment, Doors, Windows
Table of Contents**

**Chapter 1
Section 0**

Dimensions 1.10.1

Principal Dimensions 1.10.1

Turning Radius 1.10.4

Instrument Panels 1.20.1

Panel Arrangement 1.20.1

Aft Flight Deck Overview 1.20.2

Left Forward Panel 1.20.3

Right Forward Panel 1.20.4

Glareshield Panel 1.20.5

Center Forward Panel 1.20.6

Forward Aisle Stand 1.20.7

Forward Overhead Panel 1.20.9

Aft Overhead Panel 1.20.10

Control Stand 1.20.11

Aft Electronic Panel 1.20.12

Auxiliary Panels 1.20.13

Attendant Panels 1.20.14

Attendant Handset 1.20.15

Controls and Indicators 1.30.1

Flight Deck Lighting 1.30.1

Map and Chart Light Controls 1.30.1

Main Panel Lighting 1.30.1

Background and AFDS Flood Light Control 1.30.2

Flood and Aft Electronics Lights Controls 1.30.2

Overhead/Circuit Breaker Panel Light Controls 1.30.3

Dome Light Control 1.30.3

Master Lights Test and Dim Switch	1.30.4
Exterior Lighting	1.30.5
Landing, Runway Turnoff and Taxi Lights	1.30.5
Miscellaneous Exterior Lights	1.30.6
Emergency Lighting and Passenger Signs	1.30.7
Emergency Locator	1.30.9
Doors	1.30.10
Flight Deck Door	1.30.10
Exterior Door Annunciator Lights	1.30.13
Passenger Entry/Galley Service Doors	1.30.15
Oxygen	1.30.15
Oxygen Panel	1.30.15
Oxygen Mask Panel	1.30.16
Oxygen Mask and Regulator	1.30.17
Water System Controls	1.30.18
Lavatory Controls	1.30.19
Systems Description	1.40.1
Introduction	1.40.1
Lighting Systems	1.40.1
Exterior Lighting	1.40.1
Exterior Lighting Locations	1.40.3
Flight Deck Lighting	1.40.3
Passenger Cabin Lighting	1.40.3
Passenger Cabin Signs	1.40.4
Emergency Lighting	1.40.4
Emergency Exit Lighting	1.40.8
Oxygen Systems	1.40.9
Oxygen System Schematic	1.40.10
Flight Crew Oxygen System	1.40.11
Portable Protective Breathing Equipment	1.40.14
Passenger Oxygen System	1.40.14
PSU Oxygen Mask Compartment	1.40.15



737 Flight Crew Operations Manual

Passenger Portable Oxygen	1.40.16
Passenger Portable Oxygen Schematic	1.40.16
Fire Extinguishers	1.40.17
Water Fire Extinguishers	1.40.17
Halon (BCF) Fire Extinguishers	1.40.17
Fire Extinguisher Usage	1.40.19
Emergency Equipment Symbols	1.40.20
Emergency Equipment Locations	1.40.21
Doors and Windows	1.40.25
Flight Deck Door	1.40.25
Flight Deck Number Two Windows	1.40.26
Lower Cargo Compartments	1.40.27
Emergency Escape	1.40.27
Emergency Evacuation Routes	1.40.27
Flight Deck Window Emergency Egress	1.40.29
Escape Slide Detachment Handle	1.40.31
Escape Straps	1.40.32
Emergency Exit Doors	1.40.35
Pilot Seat Adjustment	1.40.38
Pilot Seat Adjustment	1.40.38
Galleys	1.40.38
Electrical Power	1.40.39
Water Service	1.40.39
Water System	1.40.39
Quantity Indication and System Operation	1.40.40
Hot Water	1.40.40
Servicing	1.40.40

Intentionally
Blank



Principal Dimensions

YE321 - YE326

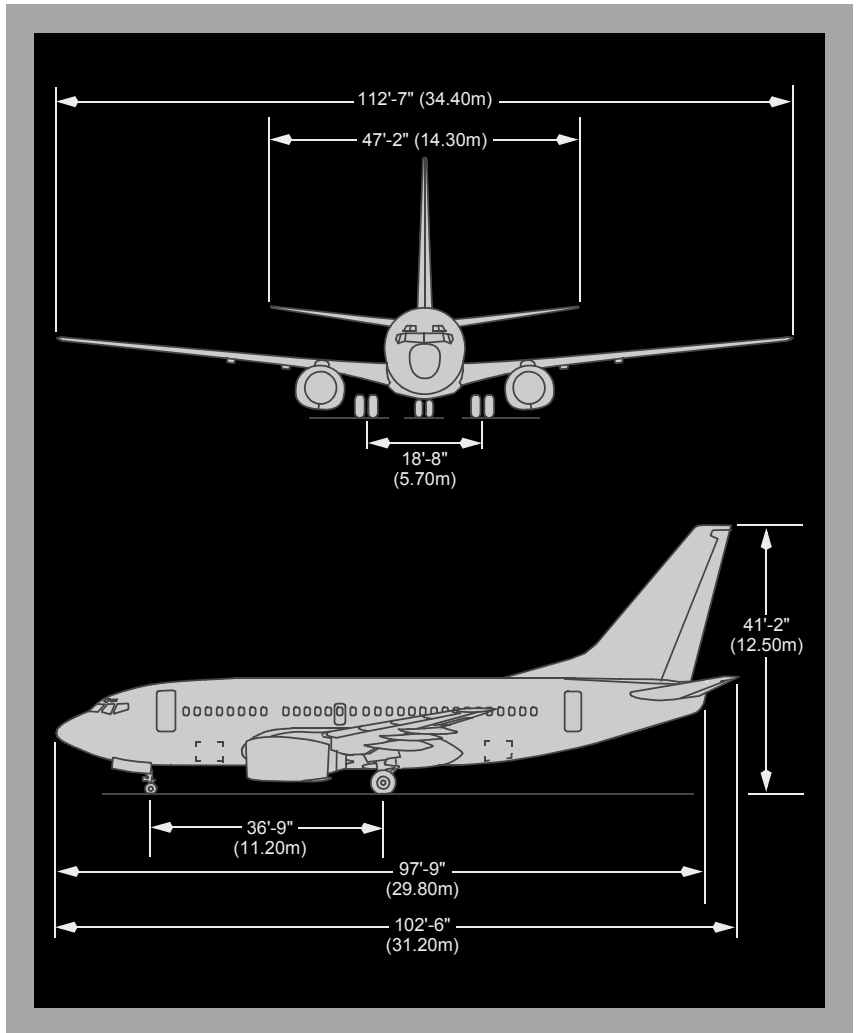

YA371 - YA377

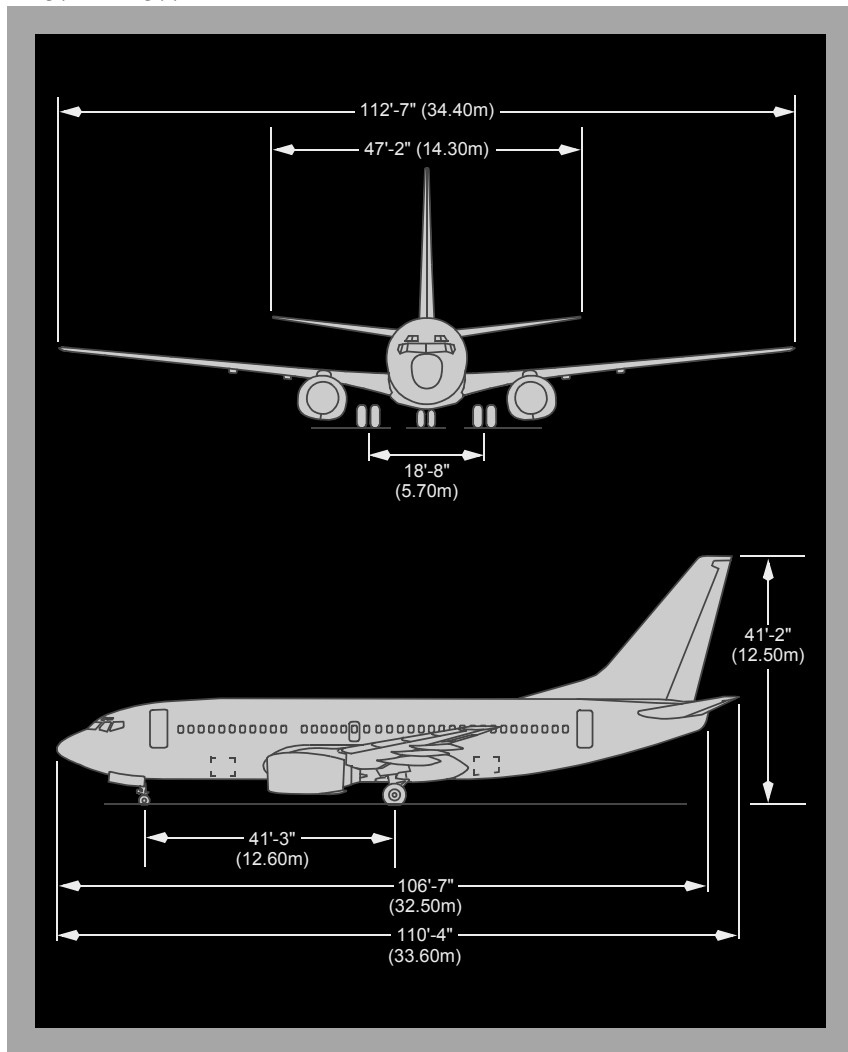

737 Flight Crew Operations Manual

YC201 - YC207

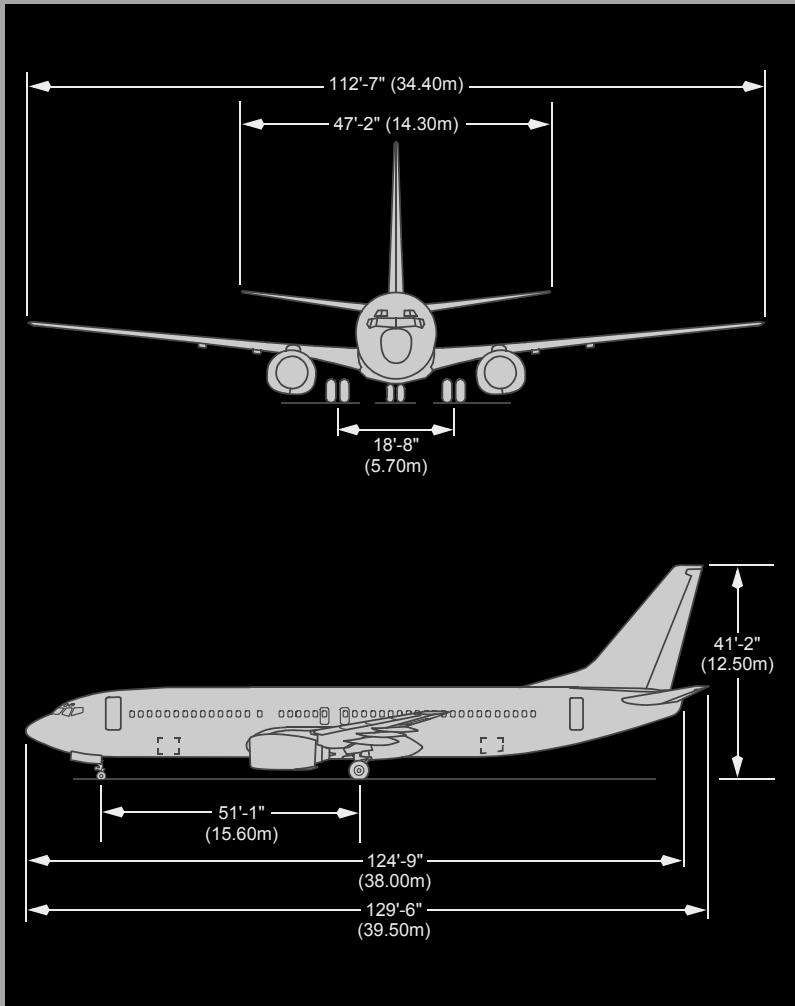

Turning Radius

YA371 - YA377, YE321 - YE326

The wingtip swings the largest arc while turning and determines the minimum obstruction clearance path. All other portions of the airplane structure remain within this arc.

YC201 - YC207

The tail swings the largest arc while turning and determines the minimum obstruction path. All other portions of the airplane remain within this arc.

YE321 - YE326

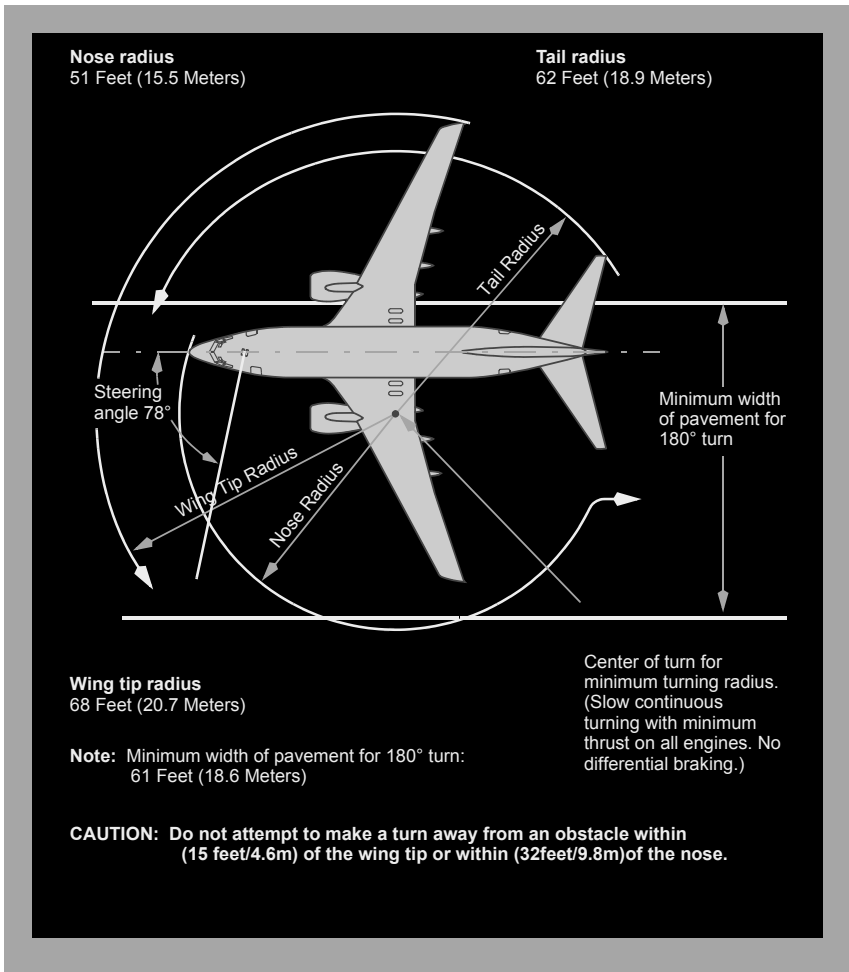

737 Flight Crew Operations Manual

YA371 - YA377

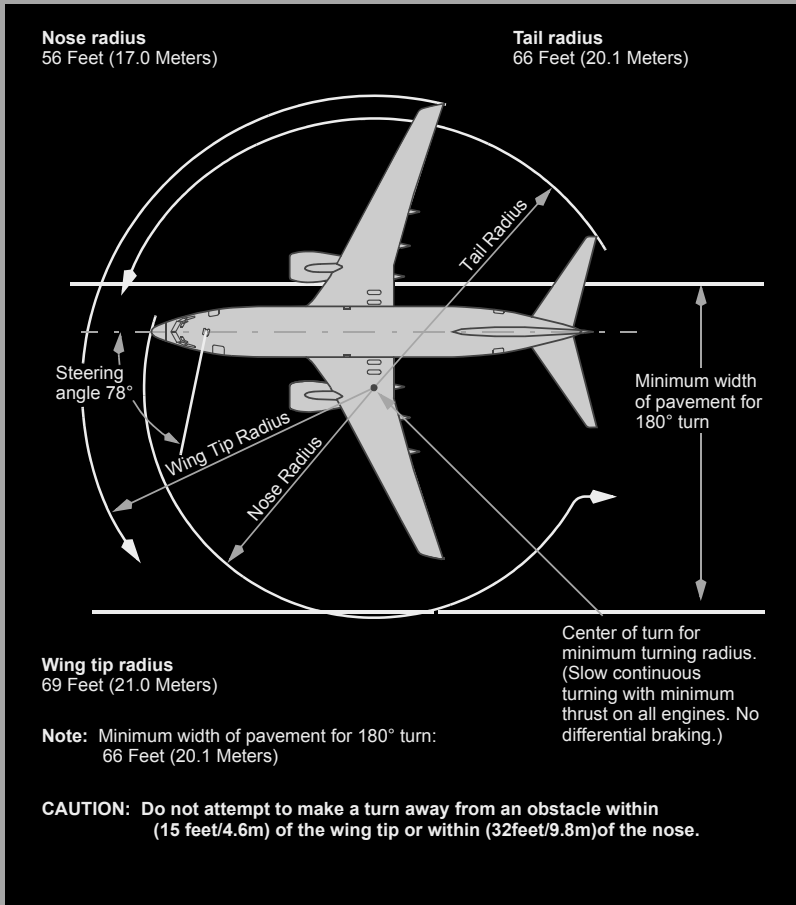

YC201 - YC207

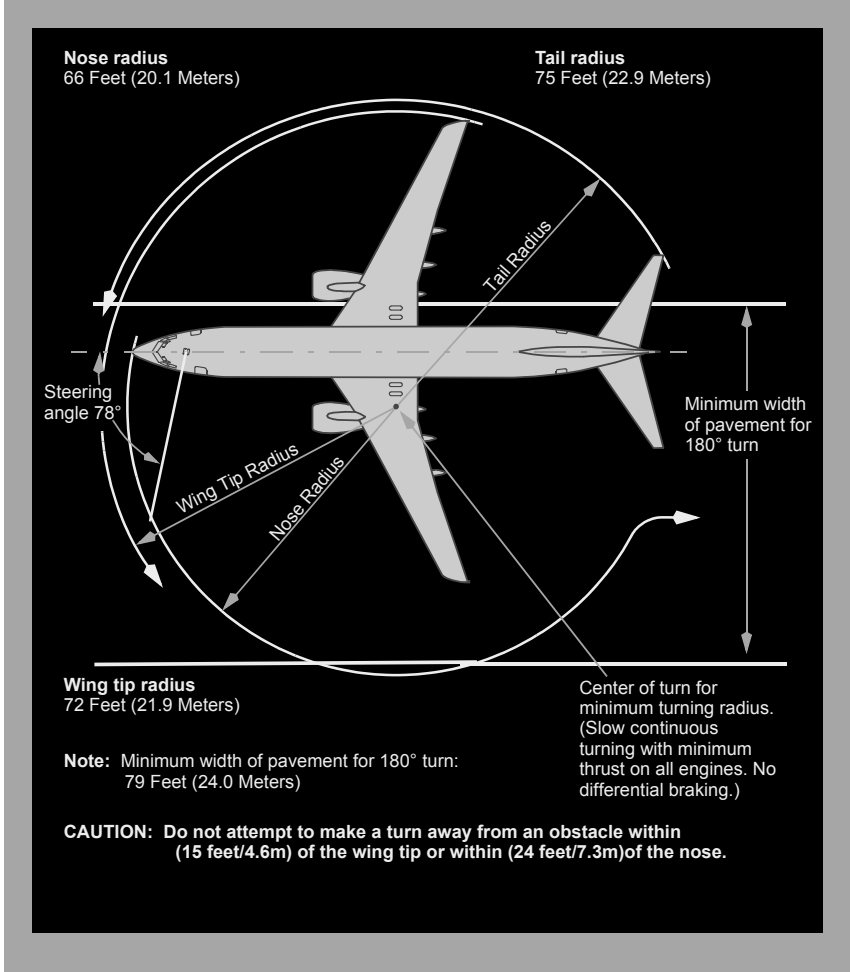

Airplane General, Emergency Equipment, Doors, Windows Instrument Panels

Chapter 1

Section 20

Panel Arrangement

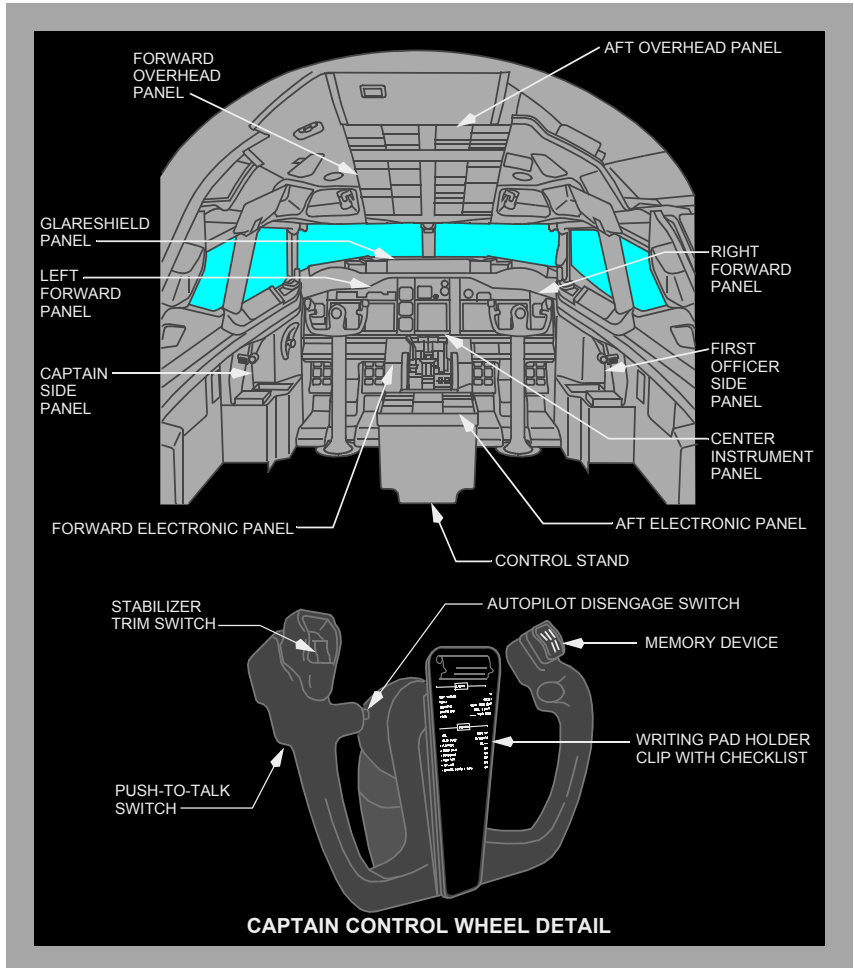

On the following pages, circled numbers refer to chapters where information on the item may be found.

The panels, controls, and indicators shown in this chapter are representative of installed units and may not exactly match the latest configuration. Refer to the appropriate chapter system descriptions for current information.

Aft Flight Deck Overview

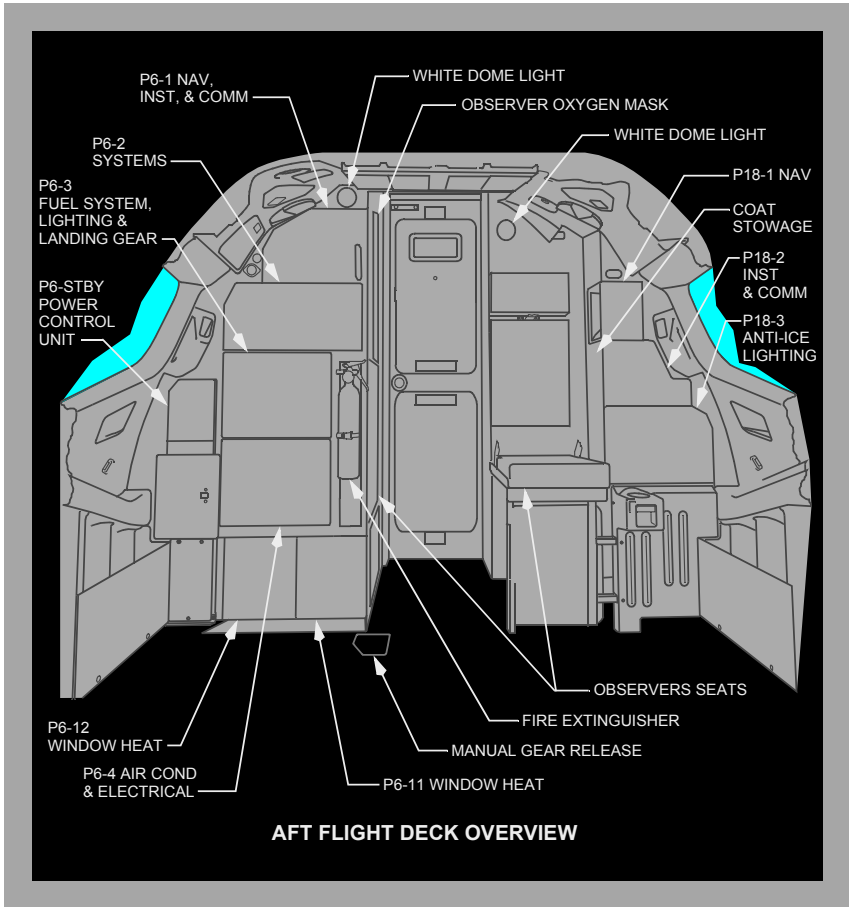

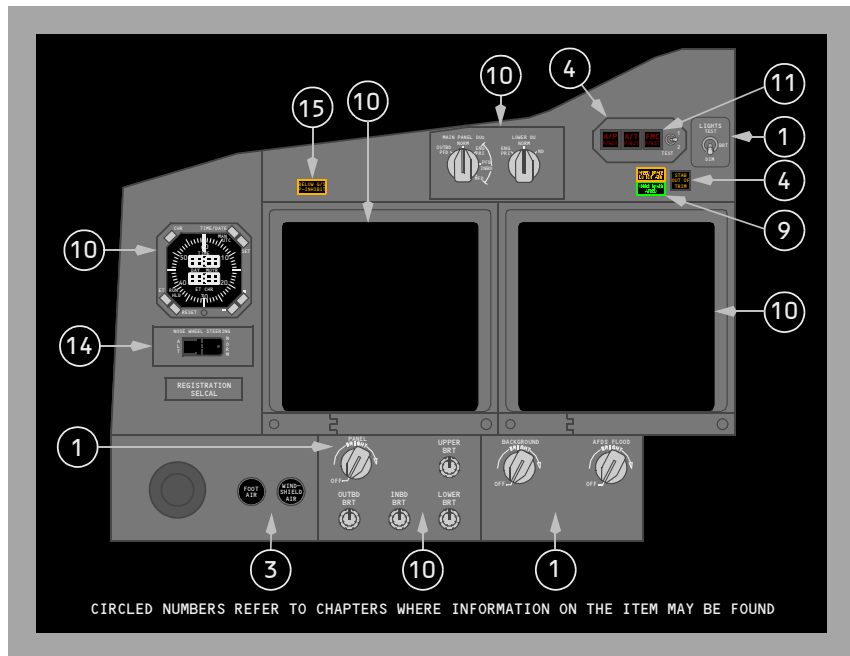
Left Forward Panel

Right Forward Panel

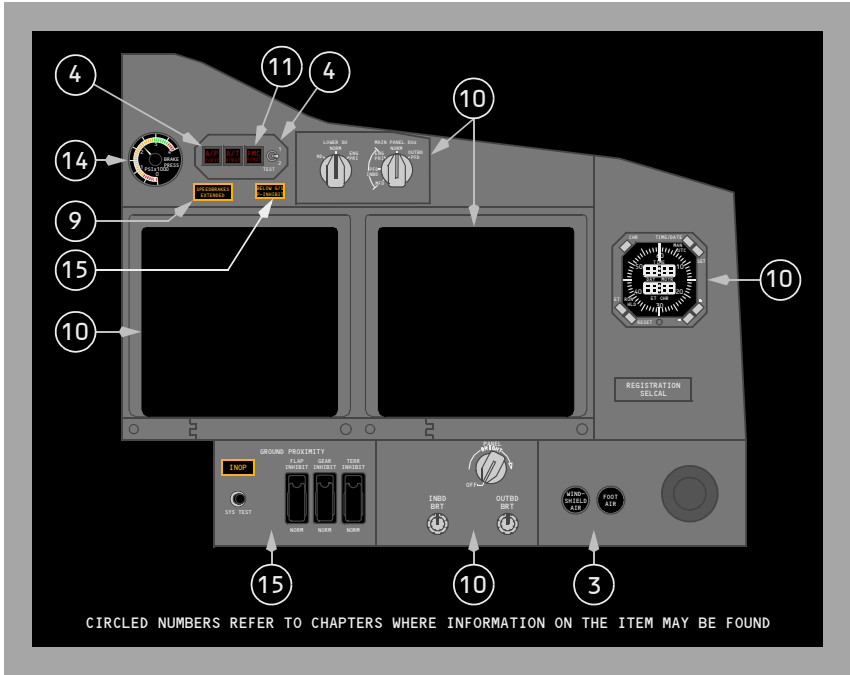

Glareshield Panel

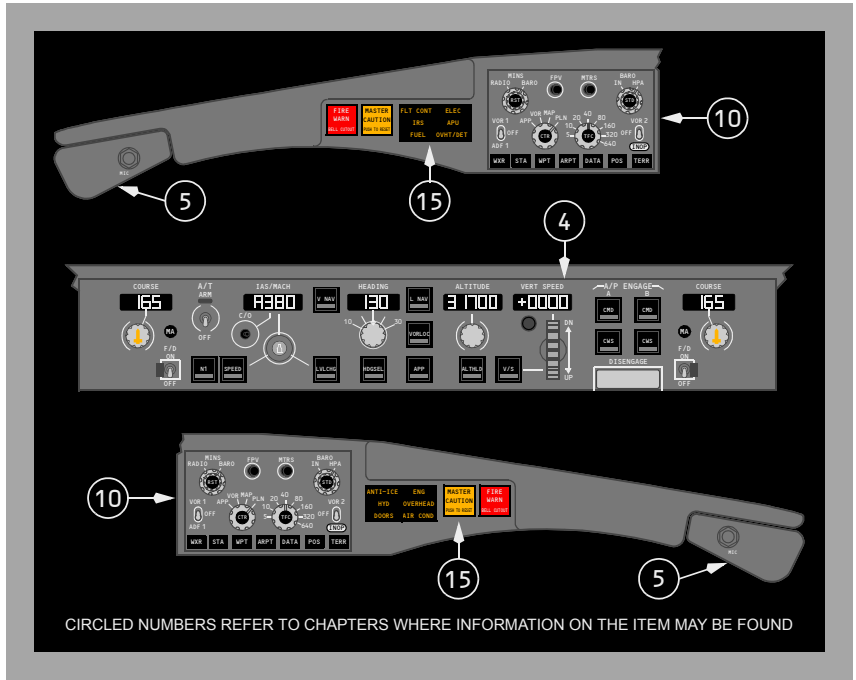

Center Forward Panel

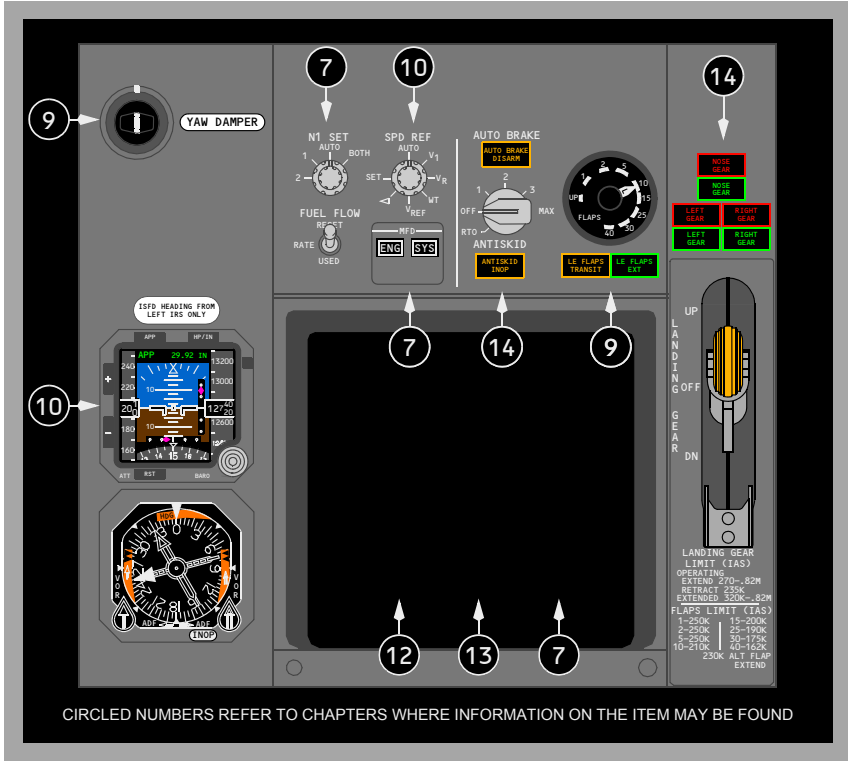

Forward Aisle Stand

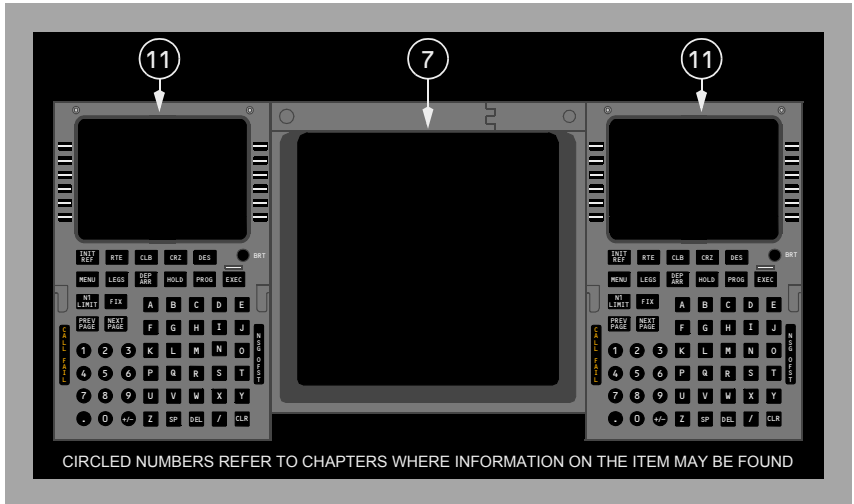

Intentionally
Blank

Forward Overhead Panel

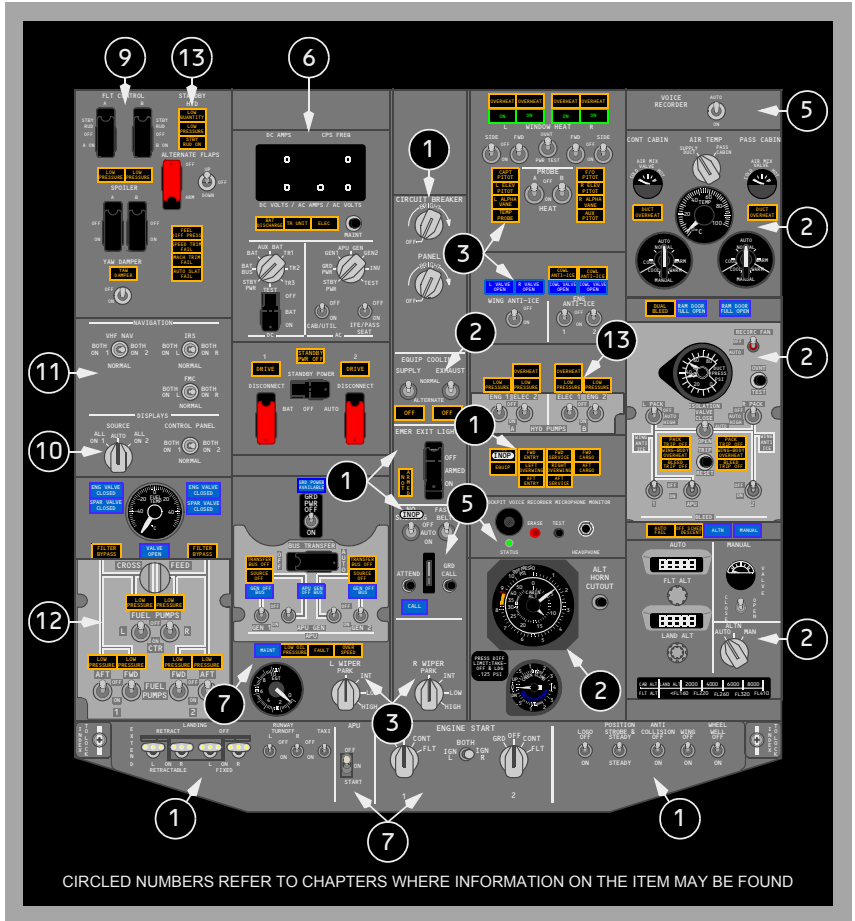

Aft Overhead Panel

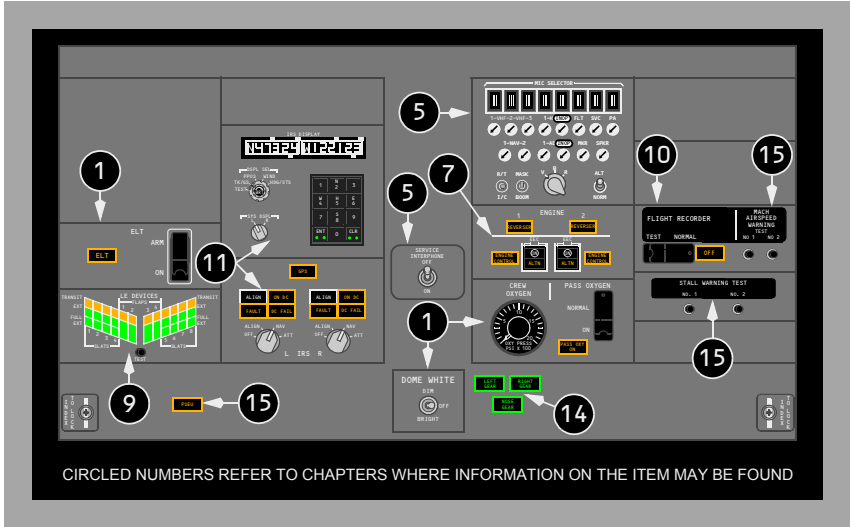

Control Stand

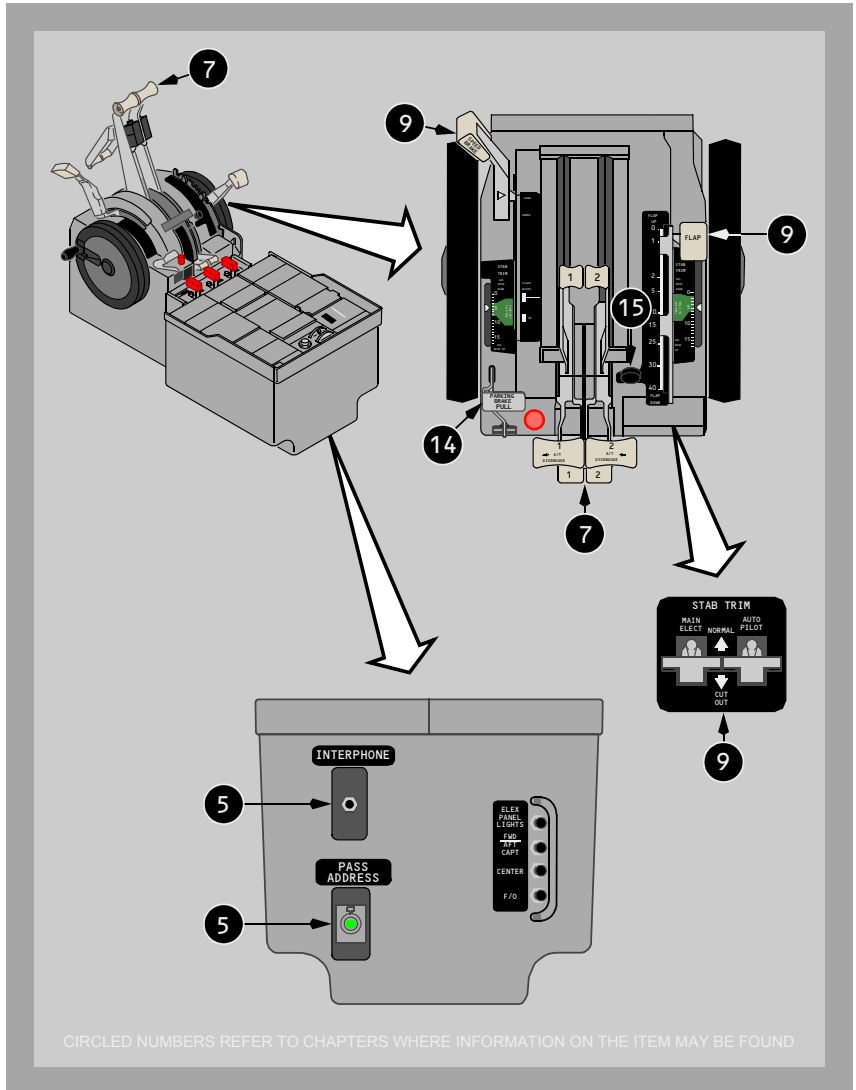

Aft Electronic Panel

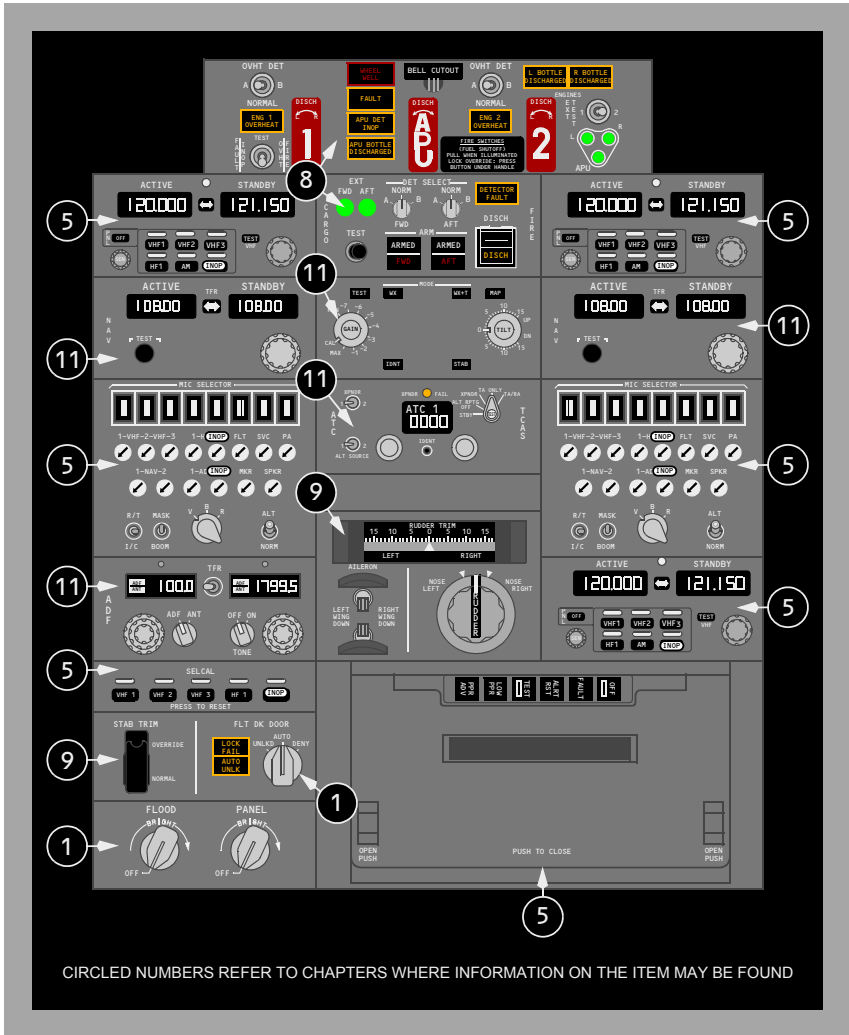

CIRCLED NUMBERS REFER TO CHAPTERS WHERE INFORMATION ON THE ITEM MAY BE FOUND

Auxiliary Panels

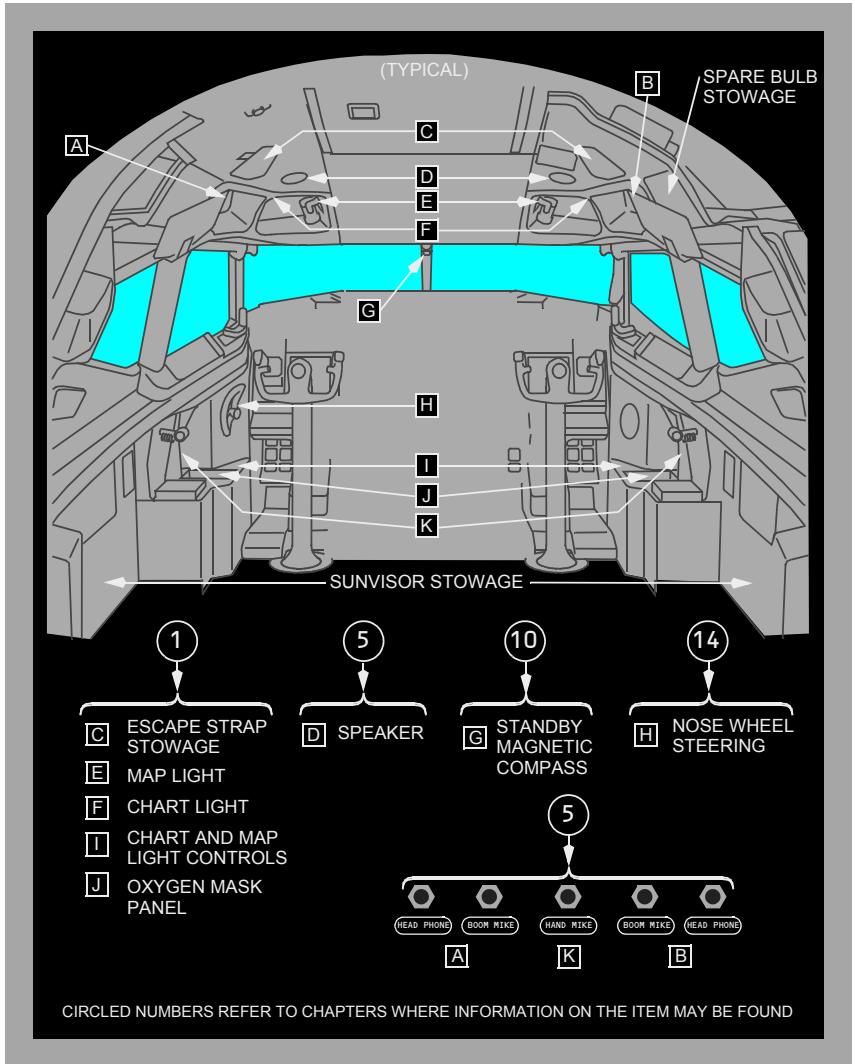

Attendant Panels

Forward Attendant Panel

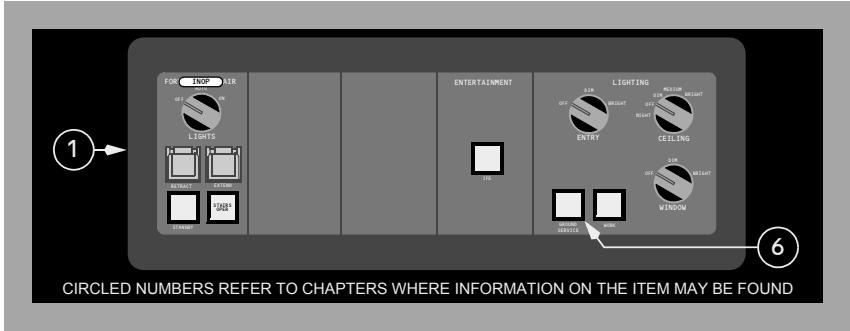

Aft Attendant Panel

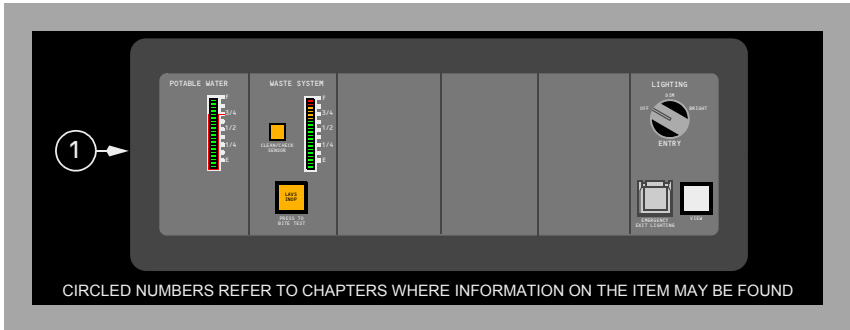

Attendant Handset

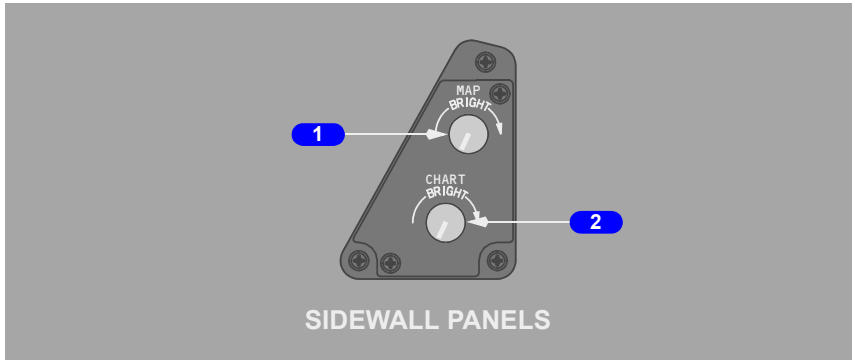

Intentionally
Blank

Flight Deck Lighting**Map and Chart Light Controls****1 MAP Light Control**

Rotate – adjusts brightness of Captain/First Officer map lights

2 CHART Light Control

Rotate – adjusts brightness of Captain/First Officer chart lights

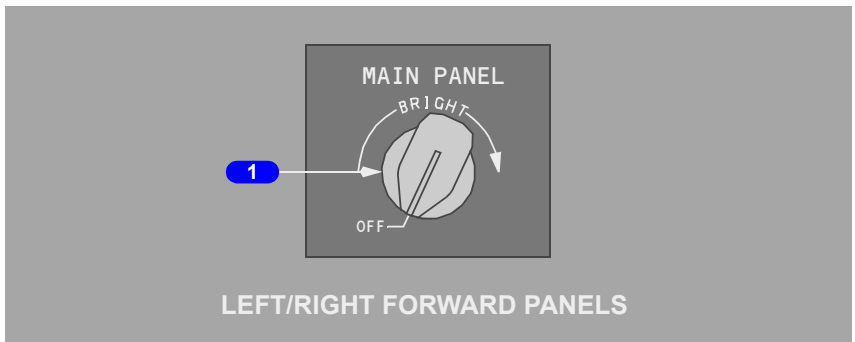
Main Panel Lighting

1 MAIN PANEL Light Control

Rotate –

- Captain – controls brightness of Captain’s panel and instrument lighting, center instrument panel, and AFDS panel displays and edge lighting
- First Officer – controls brightness of First Officer’s panel and instrument lighting.

Background and AFDS Flood Light Control

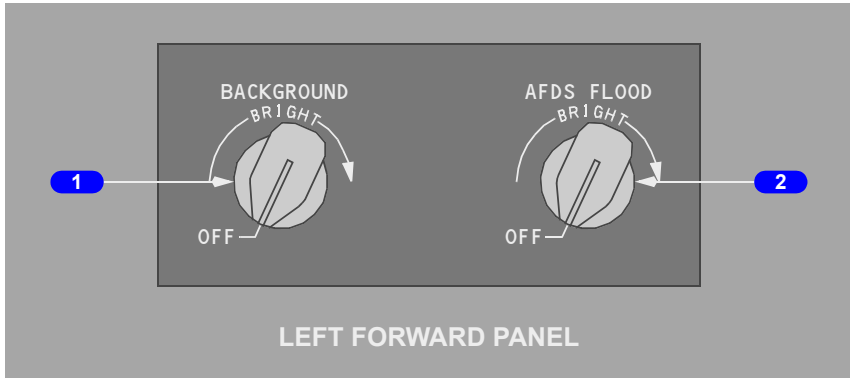

1 BACKGROUND Light Control

Rotate – controls incandescent lighting brightness for Captain’s panel, First Officer’s panel, and center panel.

2 AFDS FLOOD Light Control

Rotate – controls brightness of lighting directed at AFDS panel.

Flood and Aft Electronics Lights Controls

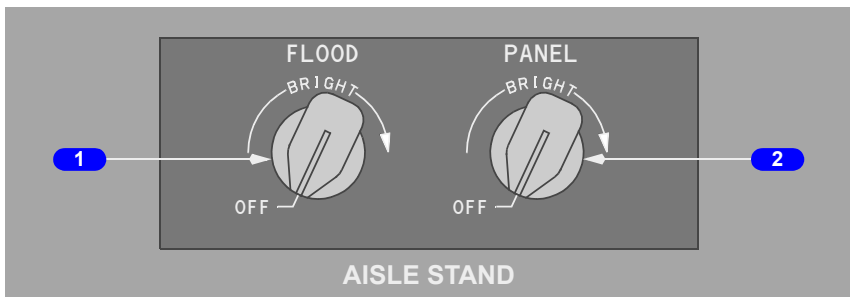

1 FLOOD Light Control

Rotate – controls overhead spotlight brightness directed at thrust lever quadrant.

2 PANEL Light Control

Rotate – controls forward and aft electronic control panel lights brightness.

Overhead/Circuit Breaker Panel Light Controls

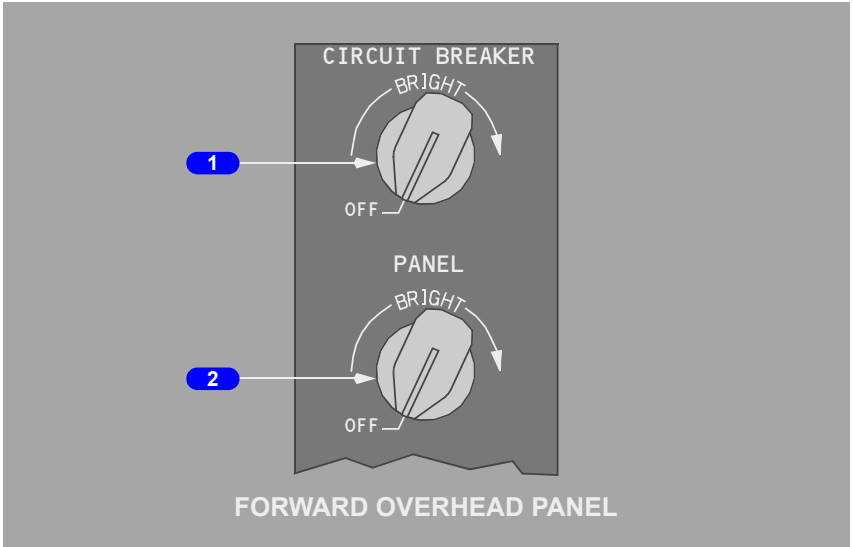

1 CIRCUIT BREAKER Light Control

Rotate – controls P-6 and P-18 circuit breaker panels light brightness.

2 PANEL Light Control

Rotate – controls forward and aft overhead panel lights brightness.

Dome Light Control

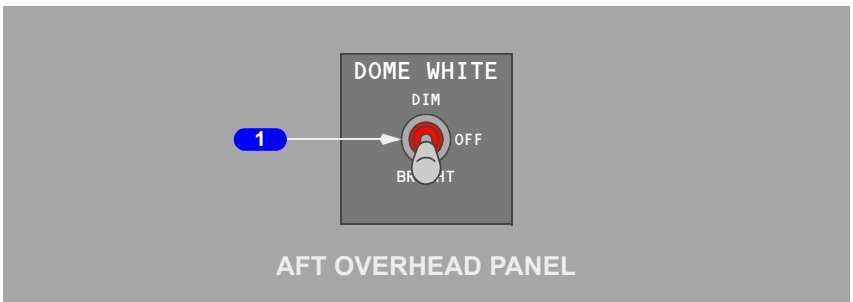

1 DOME Light Control

DIM – sets overhead dome lights to low brightness.

OFF – overhead dome lights are extinguished.

BRIGHT – sets overhead dome lights to full brightness.

Master Lights Test and Dim Switch

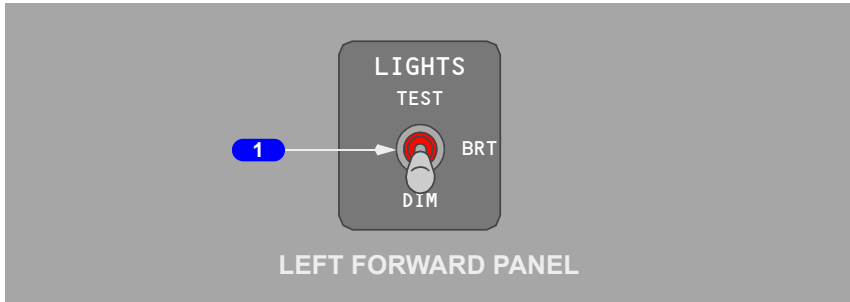

1 Master LIGHTS TEST and DIM SWITCH

TEST – illuminates all system lights on forward and aft overhead panels, and some lights on Captain and First Officer instrument panels to full brightness.

BRT (bright) – sets all system lights on forward and aft overhead panels, and some lights on Captain and First Officer panels to full brightness.

DIM – sets all system lights on forward and aft overhead panels, and some lights on Captain and First Officer panels to low brightness.

Note: Placing the Master Lights Test and Dim Switch in the TEST position will result in a master caution recall and any stored fault will cause the associated light to remain illuminated when the switch is released.

Exterior Lighting

Landing, Runway Turnoff and Taxi Lights

YA371 - YC207

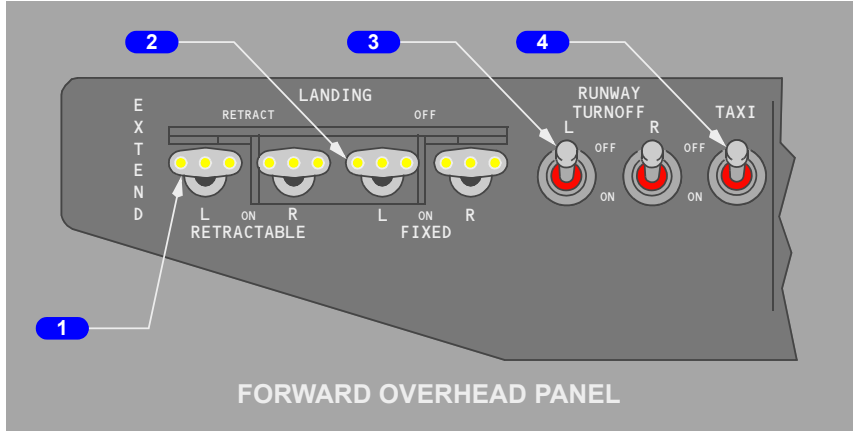

YE321 - YE326

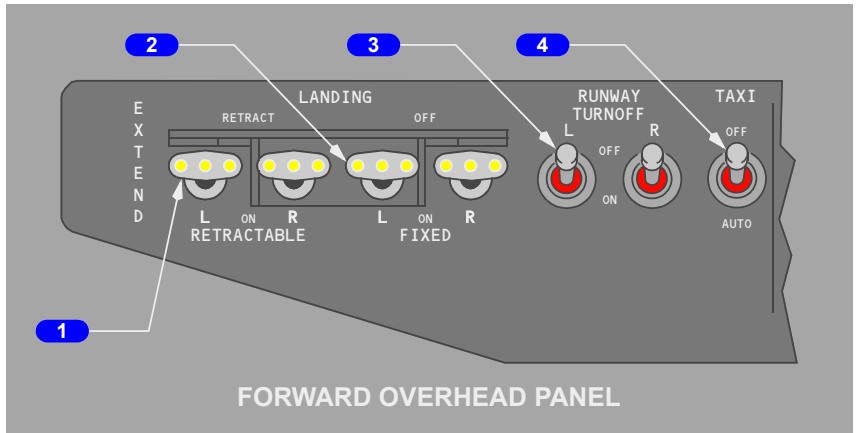

1 RETRACTABLE LANDING Light Switch

RETRACT – retractable landing lights are retracted and extinguished

EXTEND – retractable landing lights are extended and extinguished

ON – retractable landing lights are extended and illuminated.

2 FIXED LANDING Light Switch

OFF – fixed landing lights are extinguished.

ON – fixed landing lights are illuminated.

3 RUNWAY TURNOFF Light Switch

OFF – runway turnoff lights located in leading edge of wing root are extinguished.

ON – runway turnoff lights are illuminated.

4 TAXI Light Switch

YA371 - YC207

OFF – nose wheel well taxi light extinguished.

ON – nose wheel well taxi light illuminated.

4 TAXI Light Switch

YE321 - YE326

OFF – nose wheel well taxi light extinguished.

AUTO – nose landing gear taxi light automatically extinguishes when the nose landing gear retracts.

Miscellaneous Exterior Lights

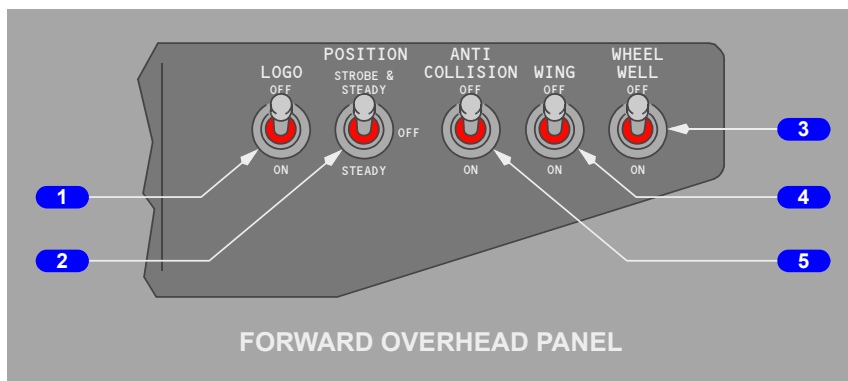

1 LOGO Light Switch

OFF – logo lights on each side of vertical fin extinguished.

ON – logo lights illuminated.

2 POSITION Light Switch

STROBE & STEADY – red and green wing-tip position lights, white trailing edge wing-tip lights and wing-tip and tail strobe lights illuminated.

OFF – red and green wing–tip position lights, white trailing edge wing–tip lights and wing–tip and tail strobe lights extinguished.

STEADY – red and green wing–tip position lights and white trailing edge wing–tip lights illuminated.

3 WHEEL WELL Light Switch

OFF – three wheel well lights extinguished.

ON – wheel well lights illuminated.

4 WING Illumination Switch

OFF – wing leading edge lights on fuselage forward of wing extinguished.

ON – wing leading edge lights illuminated.

5 ANTI-COLLISION Light Switch

OFF – red rotating beacon lights on upper and lower fuselage extinguished.

ON – red rotating beacon lights illuminated.

Emergency Lighting and Passenger Signs

Flight Deck

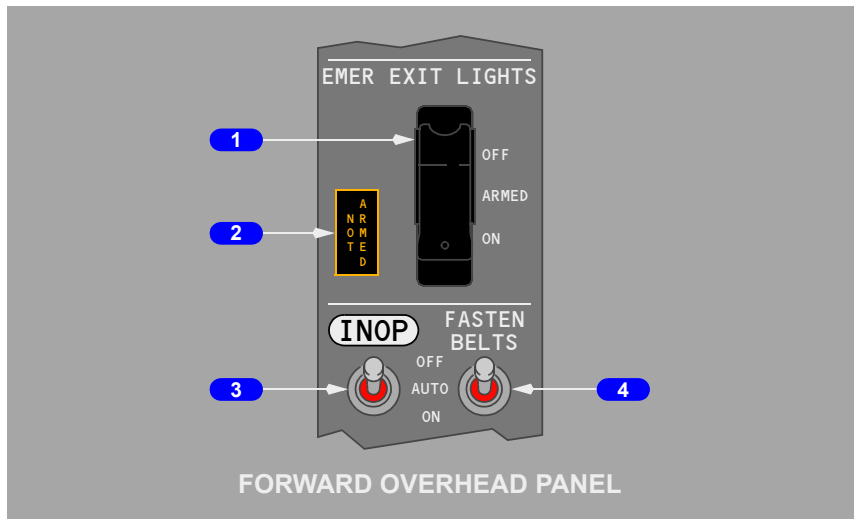

1 Emergency (EMER) EXIT LIGHTS Switch

OFF – prevents emergency lights system operation if airplane electrical power fails or is turned off.

ARMED – (guarded position) all emergency lights illuminate automatically if airplane electrical power to DC bus No. 1 fails or AC power is turned off.

ON – all emergency lights illuminate.

2 Emergency (EMER) EXIT LIGHTS NOT ARMED Light

Illuminated (amber) – EMER EXIT LIGHTS switch not in ARMED position.

3 NO SMOKING Switch

The No Smoking signs are permanently illuminated. The No Smoking switch is placarded INOP.

4 FASTEN BELTS Switch

OFF – the FASTEN SEAT BELTS and RETURN TO SEAT signs are not illuminated.

AUTO – the FASTEN SEAT BELTS and RETURN TO SEAT signs are illuminated or extinguished automatically with reference to airplane configuration (refer to the Lighting System Description section).

ON – the FASTEN SEAT BELTS and RETURN TO SEAT signs are illuminated.

Passenger Cabin

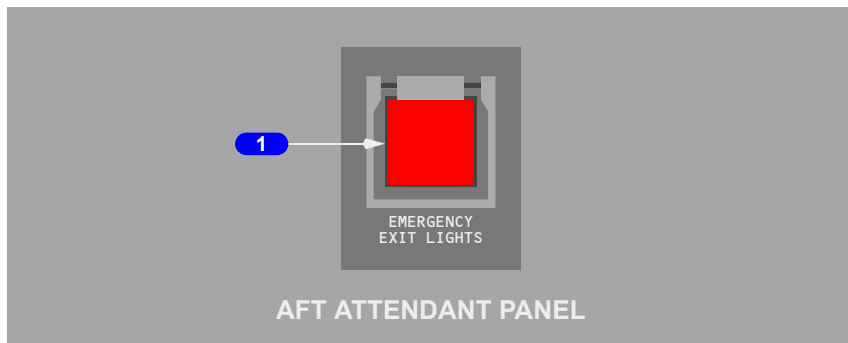

1 Passenger Cabin Emergency Lights Switch (guarded)

On – illuminates all emergency lights and bypasses flight deck control.

Emergency Locator

Emergency Locator Transmitter



1 Emergency Locator Transmitter Light

Illuminated (amber) – ELT has been activated and is simultaneously transmitting on 121.5, 243.0 and 406.0 mhz.

2 Emergency Locator Transmitter Switch

ARM – (guarded position) ELT transmits automatically when it reaches its preset G-Load limit.

ON – manually activates the ELT.

Doors

Flight Deck Door

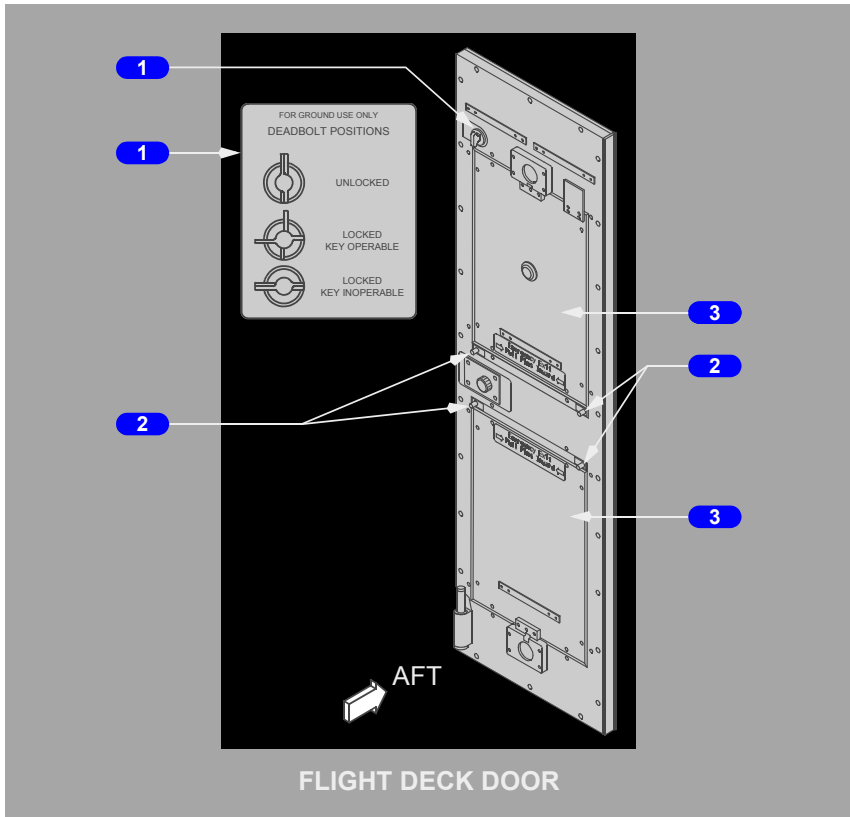

1 Deadbolt and Deadbolt Placard

2 Release Pins

Pull pins inward - manually separates decompression panel from a jammed door to allow panel opening and egress.

3 Decompression Panel

Provides emergency egress path and automatically opens during cabin decompression.

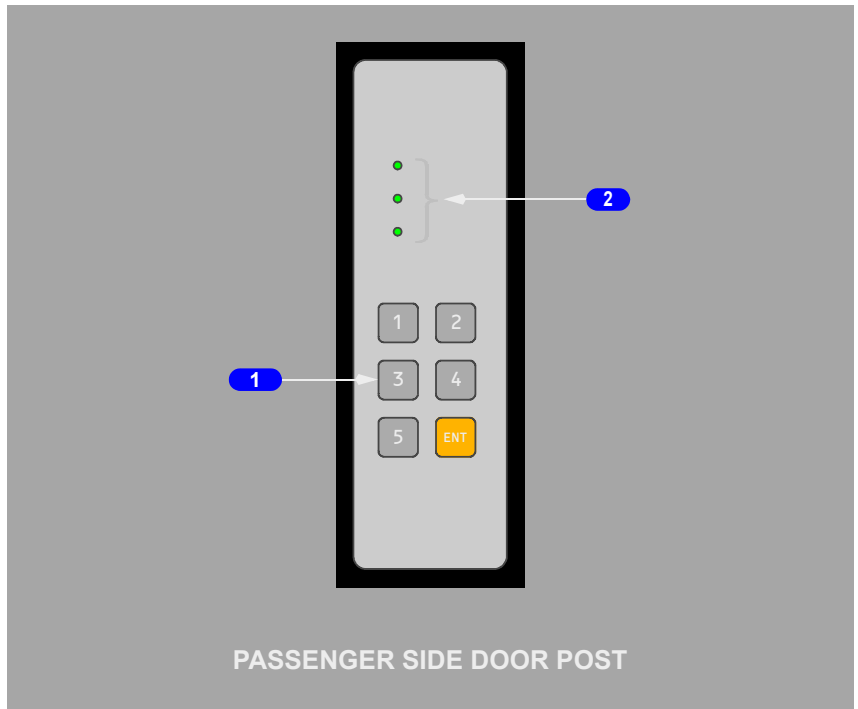
Flight Deck Emergency Access Panel**1 Keypad**

Push - enters 3 to 8 digit emergency access code by pressing numeric then "ENT" keys. Entry of correct emergency access code sounds flight deck chime.

2 Access Lights

Illuminated (red) - door locked or Flight Deck Access System switch OFF.

Illuminated (amber) - correct emergency access code entered.

Illuminated (green) - door unlocked.

Flight Deck Access System Switch

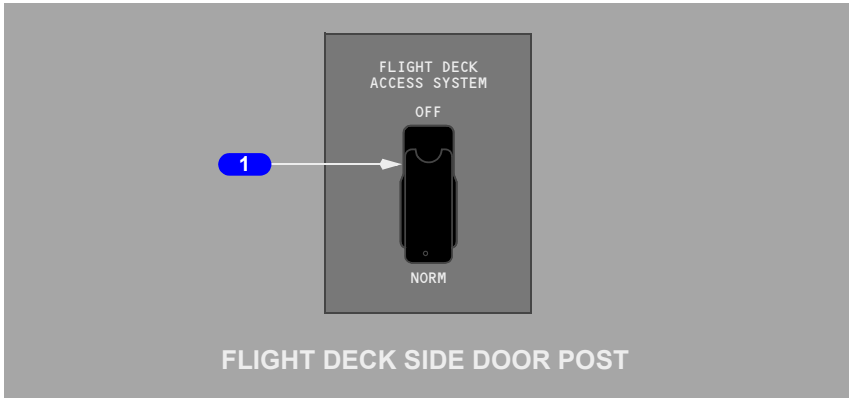

1 Flight Deck Access System Switch

OFF - removes electrical power from door lock.

NORM (Normal) - flight deck access system configured for flight.

Flight Deck Door Lock Panel

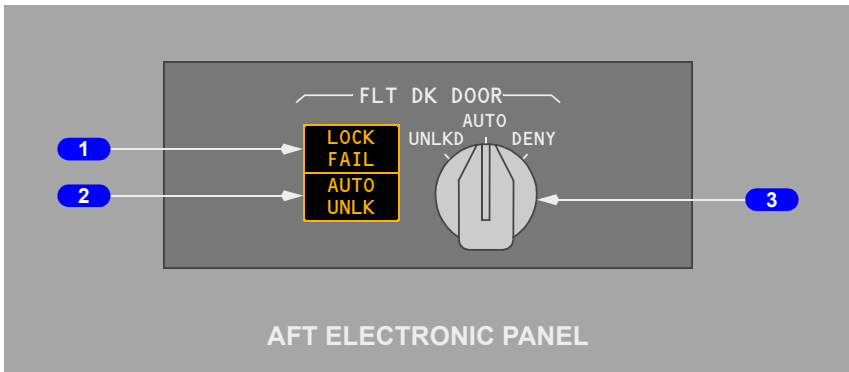

1 LOCK FAIL Light

Illuminated (amber) - Flight Deck Door Lock selector in AUTO and door lock has failed or Flight Deck Access System switch is OFF.

2 AUTO Unlock (UNLK) Light

Illuminated (amber) - correct emergency access code entered in keypad. AUTO UNLK light flashes and continuous chime sounds before timer expires and door unlocks.

3 Flight Deck (FLT DK) Door Lock Selector

Spring loaded to AUTO. Selector must be pushed in to rotate from AUTO to UNLKD. Selector must not be pushed in to rotate from AUTO to DENY.

UNLKD - door unlocked while selector in UNLKD.

AUTO - door locked. Allows door to unlock after entry of emergency access code and expiration of timer, unless crew takes action.

DENY - rejects keypad entry request and prevents further emergency access code entry for a time period.

Exterior Door Annunciator Lights

YA371 - YA377, YE321 - YE325

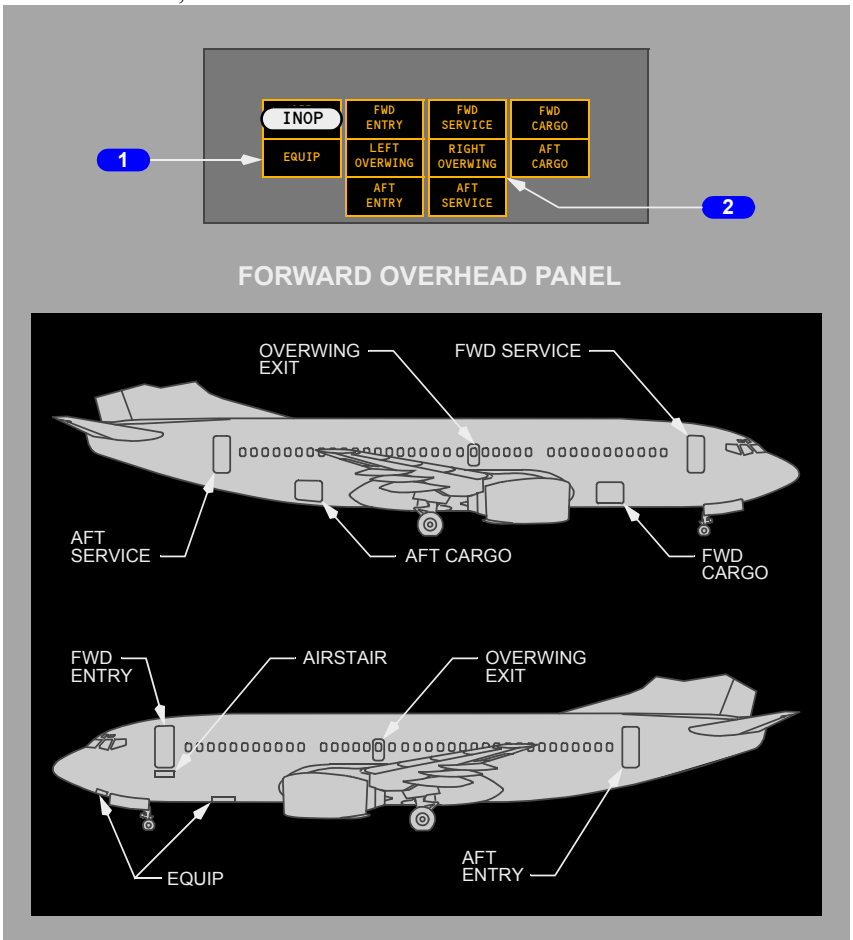

YC201 - YC207



FORWARD OVERHEAD PANEL

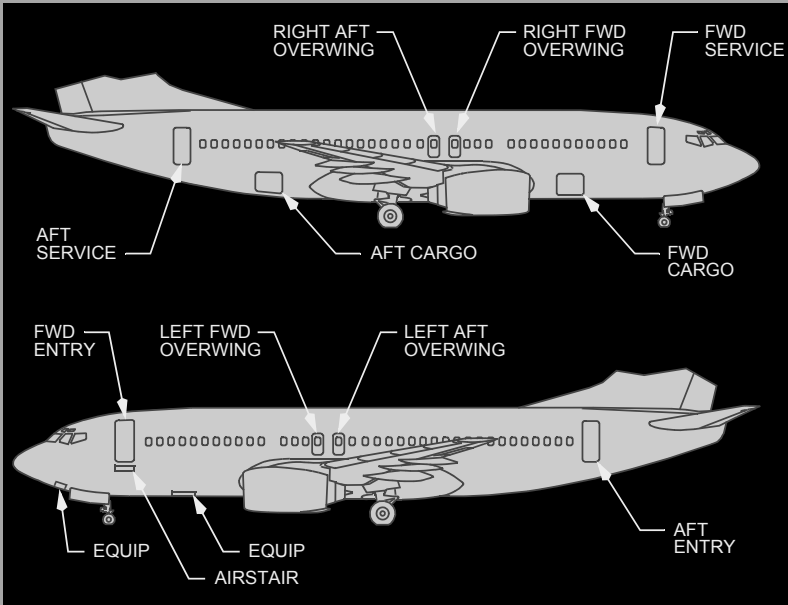

1 Exterior Door Annunciations

Illuminated (amber) – related door is not closed and locked.

2 Overwing Exit Annunciations

Illuminated (amber) –

- related overwing exit is not closed and locked
- related flight lock failed to engage when commanded locked.

Passenger Entry/Galley Service Doors

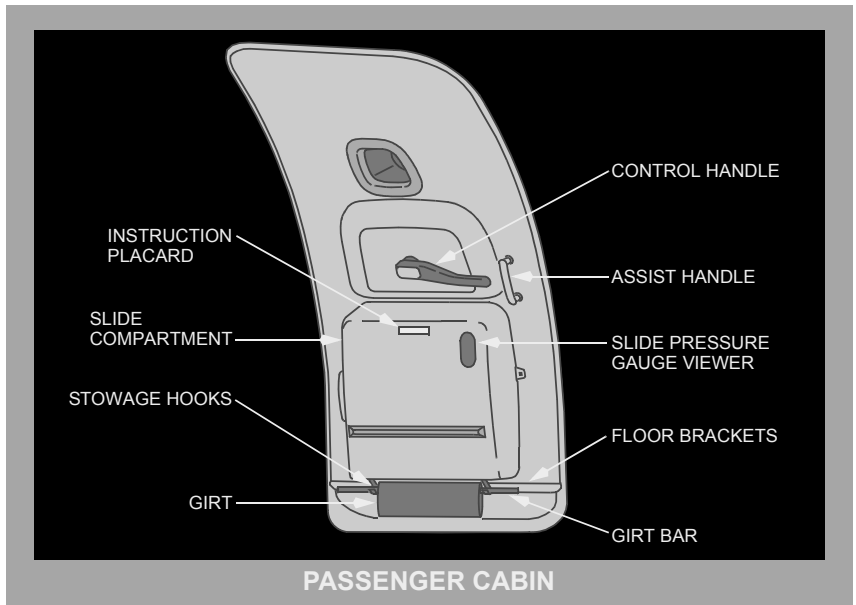

Oxygen

Oxygen Panel



1 Flight CREW OXYGEN Pressure Indicator

Indicates pressure at the crew oxygen cylinder.

2 Passenger Oxygen (PASS OXYGEN) Switch

NORMAL – (guarded position) passenger masks drop and passenger oxygen system activated automatically if cabin altitude climbs to 14,000 feet

ON – activates system and drops masks if automatic function fails.

3 Passenger Oxygen On Light

Illuminated (amber) – passenger oxygen system is operating and masks have dropped.

Oxygen Mask Panel

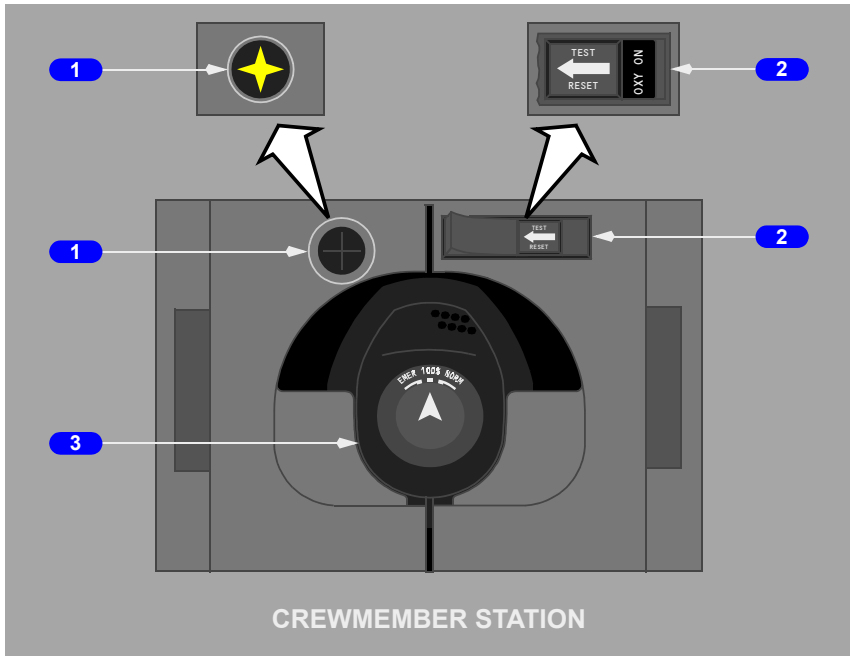

1 Oxygen Flow Indicator

Indicates a colored cross when oxygen is flowing.

2 TEST/RESET Switch

Push –

- if mask is stowed, activates oxygen flow momentarily to test regulator
- if mask is not stowed, activates mask microphone and regulator and keeps box OXY ON flag visible until released.

3 Regulator and Inflation Lever (Hidden)

Grasp Regulator and pull up –

- allows mask removal from stowage box
- initiates oxygen flow when stowage box doors open

Squeeze Inflation Lever –

- inflates harness.

Oxygen Mask and Regulator

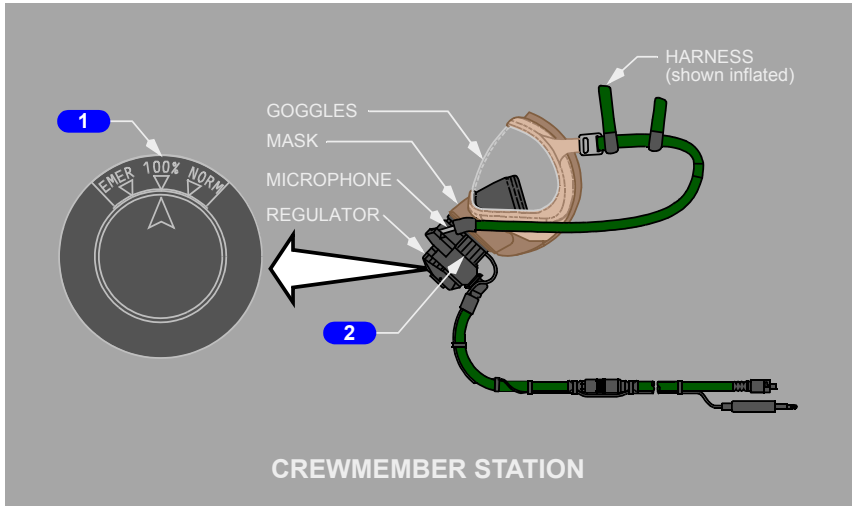

1 Regulator Selector

Rotate –

- EMER - supplies 100% oxygen under positive pressure at all cabin altitudes
- 100% - supplies 100% oxygen on demand
- NORM - supplies air/oxygen mixture on demand (ratio depends on cabin altitude)

2 Inflation Lever

Squeeze –

- inflates mask harness
- flow indicator shows a colored cross momentarily as harness inflates.

Water System Controls

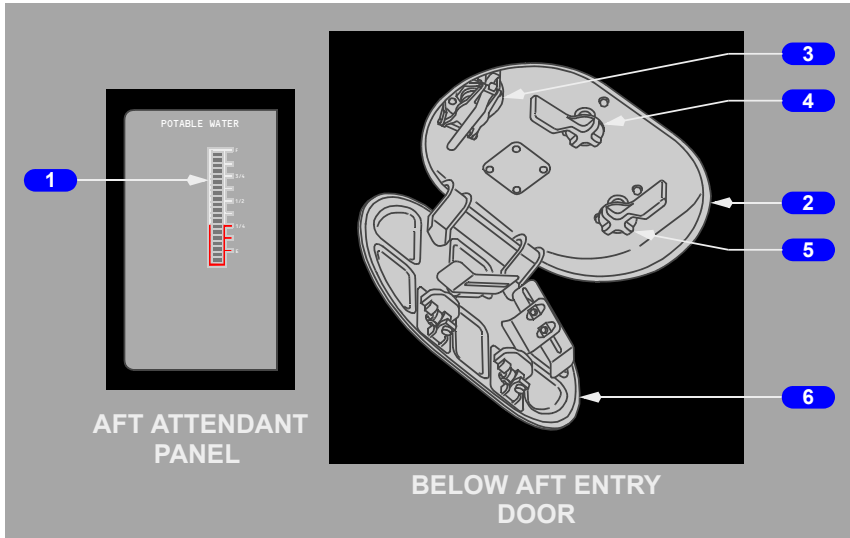

1 Water Quantity Indicator

Indicates quantity of water in reservoir.

2 Water System Service Panel

3 Fill Fitting

Used to fill tank.

4 Fill and Overflow Valve Handle

Open - enables filling or gravity draining water tank.

Closed - normal position.

5 Tank Drain Valve Handle

Open - drains water from tank.

Closed - normal position.

6 Access Panel

Cannot be closed unless the Fill and Overflow Valve and Tank Drain Valve Handles are in the closed position.

Lavatory Controls

YA371, YA372, YC201, YE321 - YE323

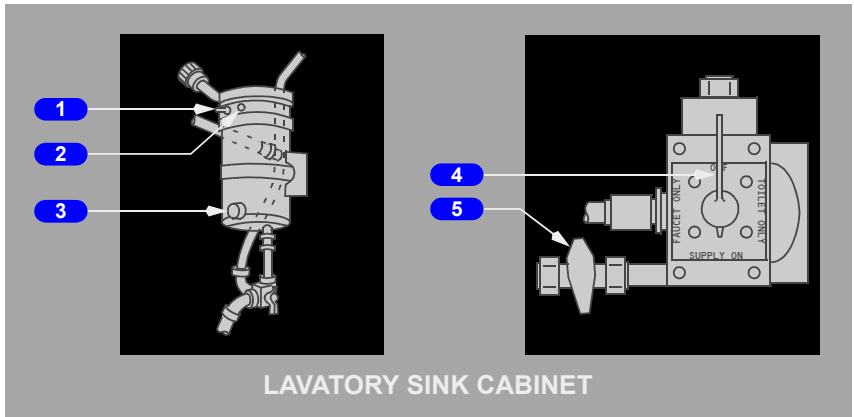
**1 Water Heater Switch**

On – activates the water heater.

2 Water Heater Light

Illuminated - heater operating.

3 Temperature Control Switch**4 Water Supply Selector Valve**

SUPPLY ON – provides water to lavatory sink faucets and water heater (normal position).

FAUCET ONLY– water is supplied to faucet only.

OFF – shuts off water to lavatory sink faucets and water heater.

TOILET ONLY– water is supplied to toilet only.

5 Drain Valve

Located in the forward lavatory.

YA373 - YA377, YC202 - YC207, YE324 - YE326

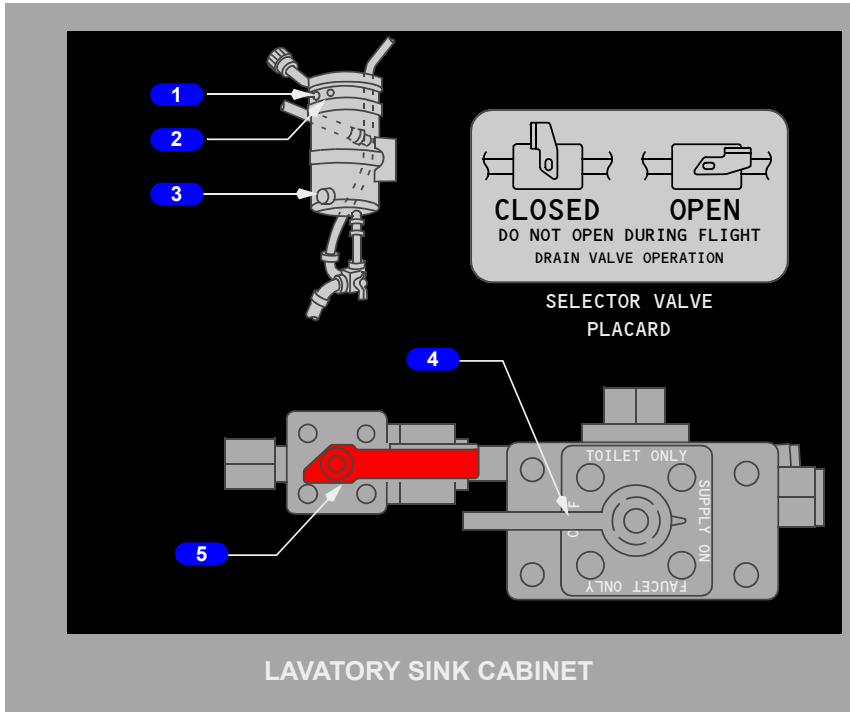

1 Water Heater Switch

On – activates the water heater.

2 Water Heater Light

Illuminated - heater operating.

3 Temperature Control Switch

4 Water Supply Selector Valve

Each lavatory has a Water Supply Selector Valve. The Water Supply Selector Valve has four positions, and is located in the cabinet below the sink.

SUPPLY ON – Normal operating position. When the water system is depressurized, all lavatories except “A” will drain. In this lavatory, the drain valve must be opened to drain the lavatory

FAUCET ONLY – In this position, water is supplied to the faucet, but not to the toilet



TOILET ONLY – In this position, water is supplied to the toilet, but not to the faucet

OFF – No water is supplied to the lavatory.

5 Drain Valve Handle (red)

Located in the forward lavatory only.

Intentionally
Blank



Introduction

This chapter describes miscellaneous airplane systems, including:

- lighting systems
- oxygen systems
- fire extinguishers
- emergency equipment
- doors and windows
- cargo compartments
- emergency egress
- flight deck seats
- galleys
- water systems
- lavatories

Lighting Systems

Lighting systems described in this chapter include:

- exterior lighting
- flight deck lighting
- passenger cabin lighting
- emergency lighting.

Exterior Lighting

Exterior lighting consists of these lights:

- landing
- runway turnoff
- taxi
- logo
- position (navigation)
- strobe
- anti-collision
- wing illumination
- wheel well.

Retractable Landing Lights

Retractable landing lights are installed in the lower airplane fuselage. The lights are designed to extend and shine forward, parallel to the waterline of the airplane. The lights may be extended at any speed.

Fixed Landing Lights

Two fixed landing lights are in the wing leading edge. The lights shine forward and down in a fixed position.

Runway Turnoff Lights

Runway turnoff lights are in each wing root. The lights illuminate the area in front of the main gear.

Taxi Lights

YA371 - YC207

The taxi light is mounted on the nose wheel strut and points in the same direction as the nose wheel.

Taxi Lights

YE321 - YE326

The taxi light is mounted on the nose wheel strut and points in the same direction as the nose wheel. The light extinguishes automatically when the nose gear is retracted.

Logo Lights

Logo lights are located on the top of each horizontal stabilizer surface to point light on both sides of the vertical stabilizer.

Position Lights

The navigation lights are the standard red (left forward wingtip), green (right forward wingtip), and white (aft tip of both wings) position lights.

Strobe Lights

Three high intensity white strobe lights are installed on the left forward wing tip, right forward wing tip, and tail cone.

Anti-collision Lights

Two red anti-collision strobe lights are located on the top and bottom of the fuselage.

Wing Illumination Lights

Wing lights are installed on the fuselage and illuminate the leading edge of the wing.

Wheel Well Lights

Lights are installed in the wheel well of the nose gear and each main gear.

Exterior Lighting Locations

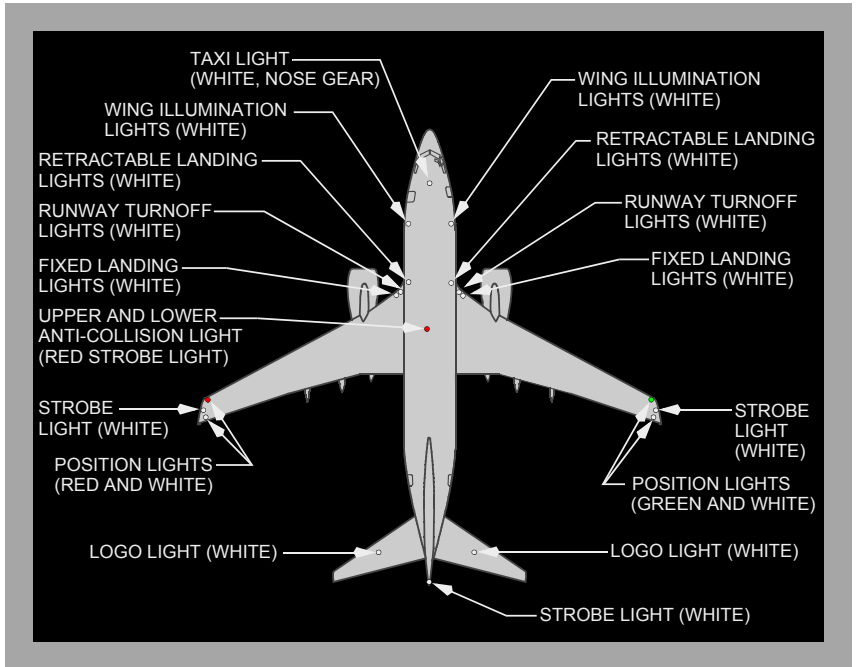

Flight Deck Lighting

Flight deck lighting is provided for panel illumination, area lighting and localized illumination. Dome lights supply general flight deck flood lighting. The glareshield supplies background light for the main instrument panels. Each instrument and instrument panel has its own integral lights. Floodlights are installed for the MCP, aisle stand, and aft circuit breaker panel.

Map lights, chart lights and utility lights are available at the pilot stations, each with individual controls.

If normal electrical power is lost, standby electrical power is automatically provided to the standby compass light, dome lights, instrument flood lights and selected system information and warning lights.

Passenger Cabin Lighting

Passenger cabin lighting is supplied by incandescent and fluorescent lights. General cabin lighting is provided by window lights, ceiling lights, and entry lights. Reading lights are located above each passenger seat in the passenger service unit. Lights are also installed in the lavatories and galleys.

Passenger Cabin Signs

The passenger cabin signs are controlled by a switch on the forward overhead panel. With Auto selected, the signs are controlled automatically by reference to landing gear and flap positions:

FASTEN BELTS and RETURN TO SEAT signs:

- illuminate when flaps or gear are extended
- extinguish when flaps and gear are retracted.

NO SMOKING signs:

- are illuminated at all times.

All passenger signs can be controlled manually by positioning the respective switch to ON or OFF.

When the passenger cabin signs illuminate or extinguish, a low tone sounds over the PA system.

Emergency Lighting

Exit lights are located throughout the passenger cabin to indicate the approved emergency exit routes. The system is controlled by a switch on the overhead panel. The switch has three positions, OFF, ARMED and ON and is guarded to the ARMED position. With the switch in the ARMED position, the emergency exit lights are normally extinguished. If electrical power to DC bus No. 1 fails or if AC power has been turned off, the emergency exit lights illuminate automatically.

The emergency exit lights may also be illuminated by a switch on the aft attendants panel. Lifting the guard and pushing the switch ON overrides the flight deck control and illuminates the emergency exit lights. Control from this panel is available in the event of failure of the automatic control.

The flight deck aft DOME light contains a separate bulb that is powered by the emergency lighting system to provide for flight deck evacuation.

Interior Emergency Lighting

Interior emergency exit lights are located:

- in the lower inboard corner of stowage bins to illuminate the aisle
- over the entry/service and overwing emergency hatches to indicate the door and hatch exits
- in the ceiling to locate the exits and provide general illumination in the area of the exits.

Self-illuminating exit locator signs are installed at the forward, middle, and aft end of the passenger cabin.



737 Flight Crew Operations Manual

A photoluminescent floor path marking system is installed along the cabin aisle. The photoluminescent material, when excited by light, will glow and provide exit path guidance. At the exit, electrically operated lights and markers provide exit identification.

The photoluminescent strips need to be properly charged. The table below contains charging information and can be used to determine how long the strips remain illuminated. For charging, the cabin ceiling, and sidewall lights need to be on at full intensity, and the strips should not be covered or blocked.

Charge Scenario	Photoluminescent Duration (Hours)	Remarks
First flight of the day - bins closed, no passengers <ul style="list-style-type: none"> • 5 minute charge • 10 minute charge • 15 minute charge • 30 minute charge • 45 minute charge 	<ul style="list-style-type: none"> • 4.25 • 8 • 9.5 • 14 • 16 	Close overhead bins during charging and cabin activity is limited to minor aisle traffic of crew and personnel. Passengers will shadow the system and are not allowed on board during charging.
First flight of the day - bins open, no passengers <ul style="list-style-type: none"> • 15 minute charge • 30 minute charge 	<ul style="list-style-type: none"> • 5.75 • 7.5 	Cabin activity is limited to minor aisle traffic of crew and personnel. Passengers will shadow the system and are not allowed on board during charging.
Photoluminescent duration can be extended beyond the initial charge, by using the following charge scenarios:		
In flight/taxi - with cabin lighting on	No limit with ceiling lights on dim or greater	
In flight/taxi - with cabin lighting off <ul style="list-style-type: none"> • 15 minute charge • 30 minute charge 	<ul style="list-style-type: none"> • 8 • 11.25 	Begin charging prior to previous discharge duration ending.

737 Flight Crew Operations Manual

Charge Scenario	Photoluminescent Duration (Hours)	Remarks
Ground turn with bin doors open and passengers in seats <ul style="list-style-type: none">• 15 minute charge• 30 minute charge	<ul style="list-style-type: none">• 6.75• 9	Bin doors can be open during charging. Passenger loading and unloading periods cannot be included in the charge time. Passengers can be on the airplane. Begin charging prior to previous discharge duration.
Ground turn with bin doors open and no passengers in seats <ul style="list-style-type: none">• 15 minute charge• 30 minute charge	<ul style="list-style-type: none">• 7.5• 10	Bin doors can be open during charging. Passenger loading and unloading periods cannot be included in the charge time. Passengers cannot be on the airplane. Begin charging prior to previous discharge duration.

Exterior Emergency Lighting

Exterior emergency lights illuminate the escape slides. The fuselage installed escape slide lights are adjacent to the forward and aft service and entry doors. Lights are also installed on the fuselage to illuminate the overwing escape routes and ground contact area.

Emergency Exit Lighting

YA371 - YA377, YE321 - YE326

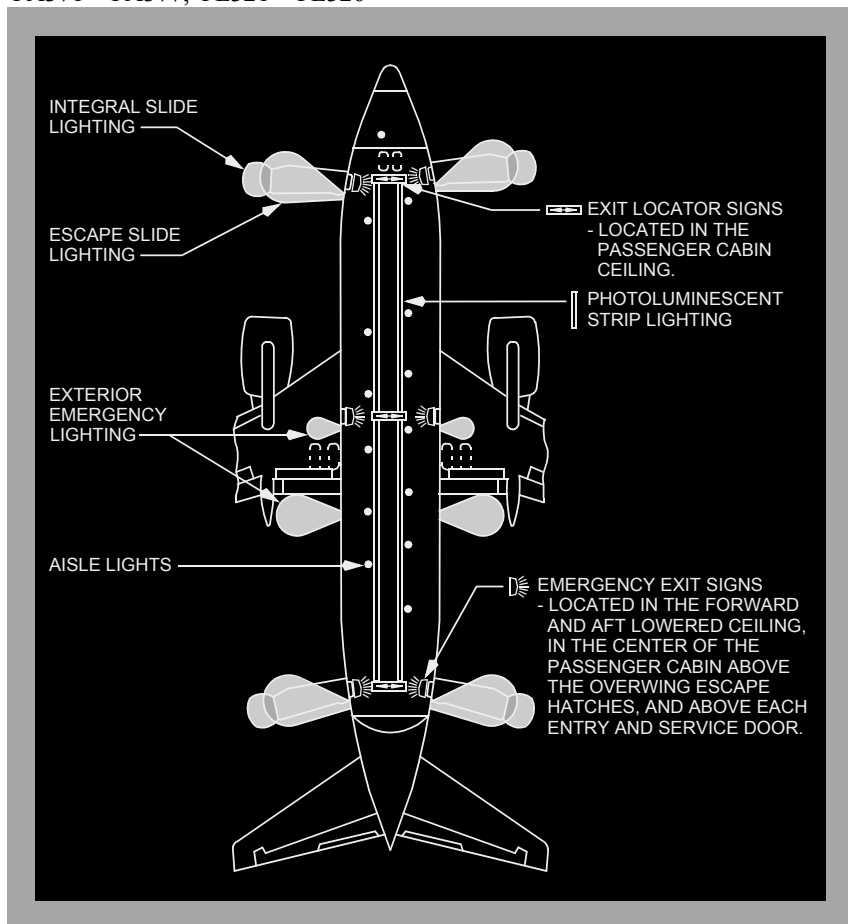

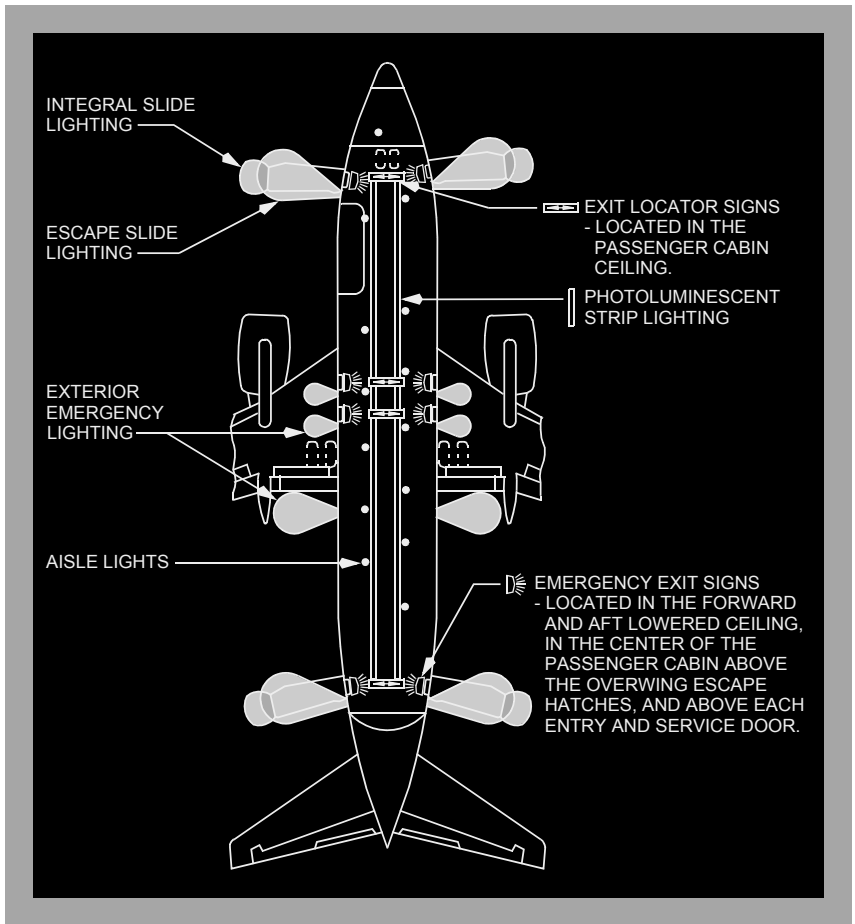
YC201 - YC207

Oxygen Systems

Two independent oxygen systems are provided, one for the flight crew and one for the passengers. Portable oxygen cylinders can be located throughout the airplane for emergency use. These cylinders are normally found in the forward and aft areas of the passenger cabin.

Oxygen System Schematic

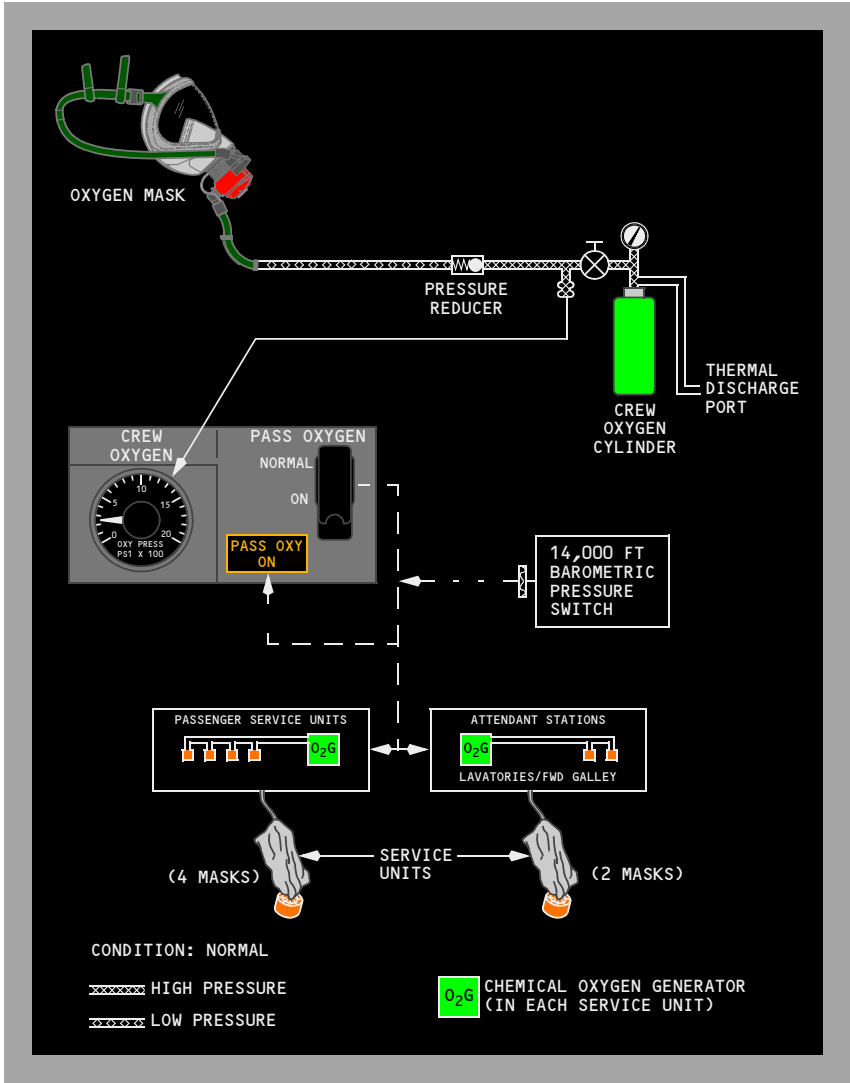

Flight Crew Oxygen System

The flight crew oxygen system uses automatic pressure-breathing masks/regulators located at each crew station. Pressure breathing occurs above 27,000 feet. Oxygen is supplied by a single cylinder. Oxygen pressure is displayed on the indicator located on the aft overhead panel. Oxygen flow is controlled through a pressure-reducing regulator to supply low-pressure oxygen. System pressure may be as high as 1850 psi.

Oxygen flow is controlled by a regulator that is mounted on the oxygen mask. The regulator may be adjusted to supply NORMAL, 100% or EMERGENCY oxygen by rotating the regulator selector.

Flight Crew Oxygen Mask Usage

Donning Instructions

To don the oxygen mask accomplish the following:

- Grasp the regulator with the hand nearest the stowage box.
- Pull upward to expose the entire regulator and inflation lever.
- Re-grip the regulator and squeeze the inflation lever while pulling the mask from the stowage box.
- Pull the mask across in front of you, toward the center of the aircraft (to ensure ample hose extension), while rolling the mask face-up.
- Lean slightly toward the center of the airplane and place your face into the mask so the chin contacts the lower part of the mask first, then roll the top of the mask toward your forehead so the harness goes over and behind your head.
- Release the inflation lever so the harness holds the mask in place.

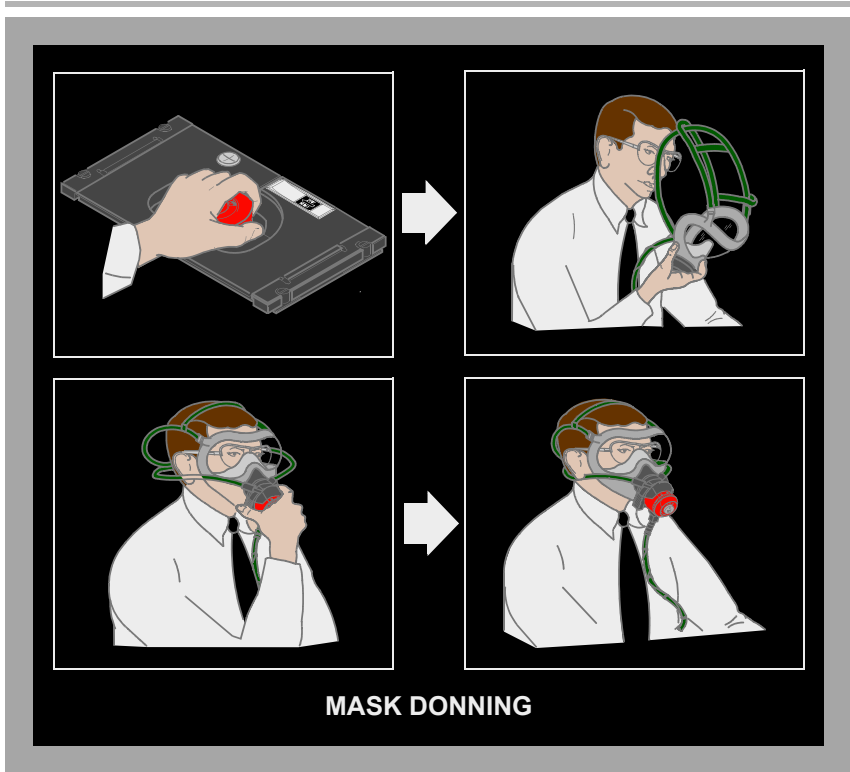

Flight Crew Oxygen Mask Stowing Instructions

To stow the oxygen mask accomplish the following:

- Set the regulator to “100%.”
- Ensure that the cloth liner is secured at the top of the stowage box and is laying flat against all interior sides of the box.
- Coil the supply hose into the bottom of the stowage box, making the largest diameter possible.
- Ensure that the harness is completely deflated.
- Hold the mask by the regulator with the facepiece down and the inside of the mask toward you.
- Grasp the harness “cross,” then pull it downward toward the top of the facepiece and tightly roll the mask around it. Allow the excess harness to hang down from the top of the rolled facepiece.

CAUTION: Do not push the harness “cross” straps into or behind the nose piece. Doing this may cause the cross straps to hang up on the mask during inflation.

- Position the supply hose along the side of the rolled facepiece on the outboard side (relative to the aircraft).
- Insert the mask-regulator assembly into the stowage box, beginning with the harness (regulator up).
- Press down on the mask-regulator until all but the regulator control knob is below the top surface of the stowage box.
- Close the right-hand door. The “OXY ON” flag will slide into view.
- Close the left-hand door, ensuring not to pinch the hose
- Press, then release the “TEST AND RESET” control lever on the right-hand door. Ensure that the “OXY ON” flag disappears when the lever is released.

WARNING: Do not push the red Release Levers on the regulator. Doing this will inflate the harness and prevent the correct stowage of the mask-regulator.

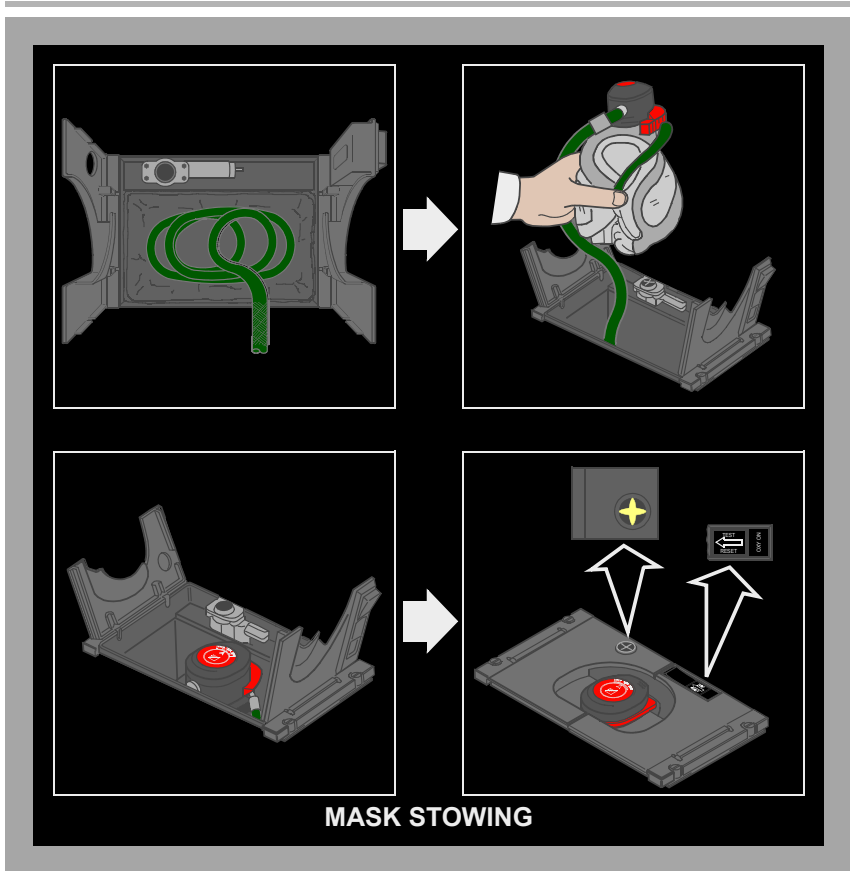

Portable Protective Breathing Equipment

Protective Breathing Equipment (PBE/Smoke Hood) devices for crew use (for combating fires and/or entering areas of smoke or fume accumulation) may be stowed throughout the airplane; however, they are normally found in the forward and aft sections of the passenger cabin. The device is placed over the head and, when activated, provides approximately 15 to over 20 minutes of oxygen depending upon the device used. Manufacturer's operating instructions are placarded on the container.

Passenger Oxygen System

The passenger oxygen system is supplied by individual chemical oxygen generators located at each Passenger Service Unit (PSU). Four continuous flow masks are connected to each generator. A generator with two masks is located above each attendant station and in each lavatory.

737 Flight Crew Operations Manual

The system is activated automatically by a pressure switch at a cabin altitude of 14,000 feet or when the Passenger Oxygen Switch on the aft overhead panel is positioned to ON. When the system is activated, the PASS OXY ON light illuminates and OVERHEAD illuminates on the Master Caution System.

Activating the system causes the masks to drop from the stowage compartments. The oxygen generators are activated when any mask in the unit is pulled down. Pulling one mask down causes all masks in that unit to come down and 100% oxygen flows to all masks. A green in-line flow indicator is visible in the transparent oxygen hose whenever oxygen is flowing to the mask. Oxygen flows for approximately 12 minutes and cannot be shut off. If the passenger oxygen is activated and a PSU oxygen mask compartment does not open, the masks may be dropped manually.

PSU Oxygen Mask Compartment

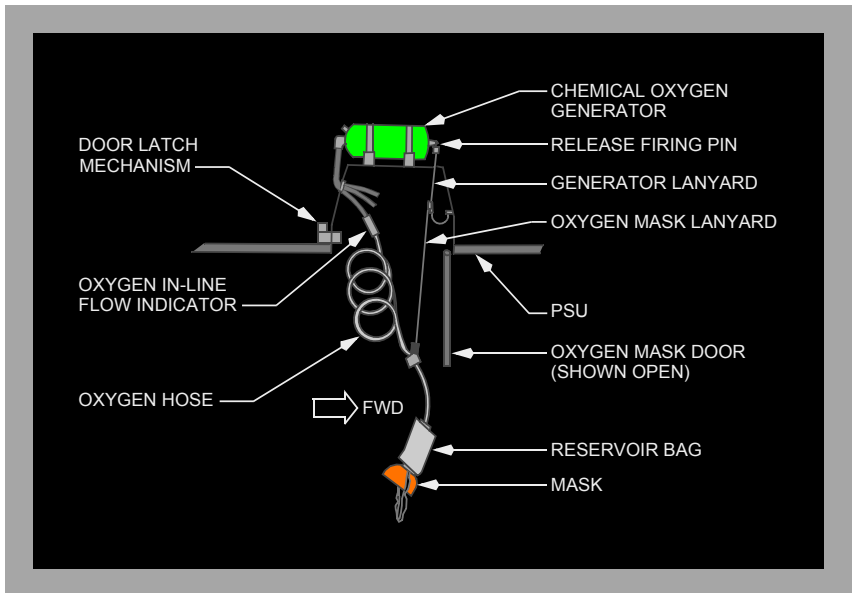

WARNING: When using passenger oxygen, the “NO SMOKING” sign should be strictly observed. Once the generator is activated, the flow of oxygen is constant, whether or not the mask is being worn.

WARNING: Do not use passenger oxygen with cabin altitude below 14,000 feet when smoke or an abnormal heat source is present. The use of passenger oxygen does not prevent the passengers from inhaling smoke. Air inhaled is a mixture of oxygen and cabin air.

Passenger Portable Oxygen

First aid and supplemental portable oxygen cylinders are installed at suitable locations in the passenger cabin. The cylinders are fitted with a pressure gage, pressure regulator and on-off valve. The cylinders are pressurized to 1800 psi. At this pressure and a temperature of 70 degrees Fahrenheit, (21 degrees Celsius) the cylinders have a capacity of 4.25 cubic feet (120 liters) of free oxygen. Two continuous flow outlets are provided on each cylinder, one regulates flow at two liters per minute for walk-around; the second outlet provides flow at four liters per minute. The four-liter flow is used for first aid.

Duration can be determined by dividing capacity by outflow (120 liters divided by 4 liters/minute = 30 minutes).

Passenger Portable Oxygen Schematic

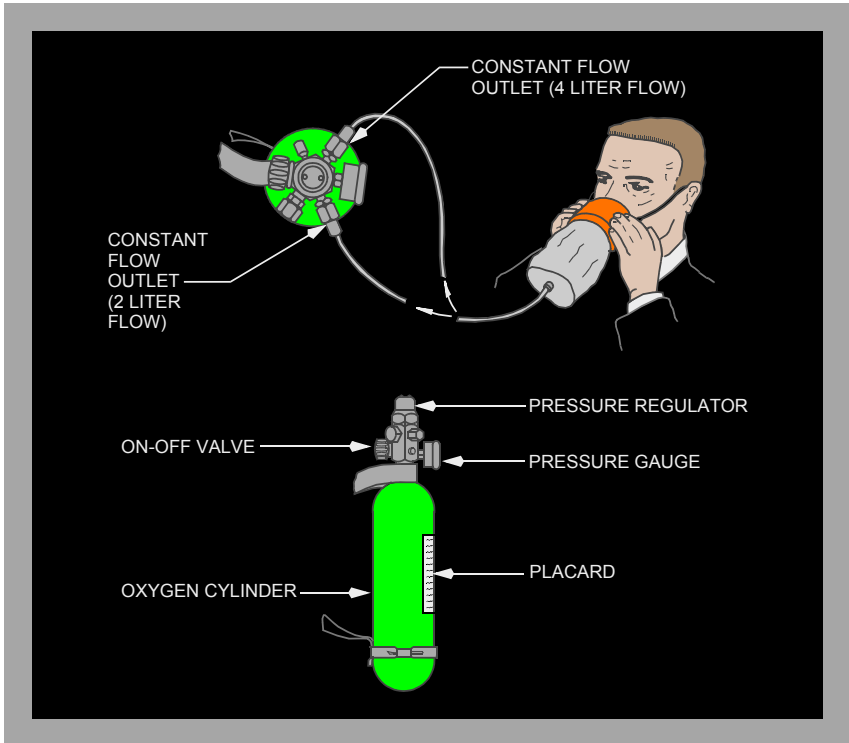

Fire Extinguishers

Fire extinguishers are located in the flight deck and passenger cabin.

Water Fire Extinguishers

Water fire extinguishers contain a solution of water mixed with antifreeze. The container is pressurized by a CO₂ cartridge when the extinguisher handle is rotated fully clockwise. The extinguisher should be used on fabric, paper or wood fires only.

To use the water fire extinguisher:

- remove from stowage
- rotate handle fully clockwise
- aim at base of fire and press trigger.

CAUTION: Do not use on electrical or grease type fires.

Water Fire Extinguisher

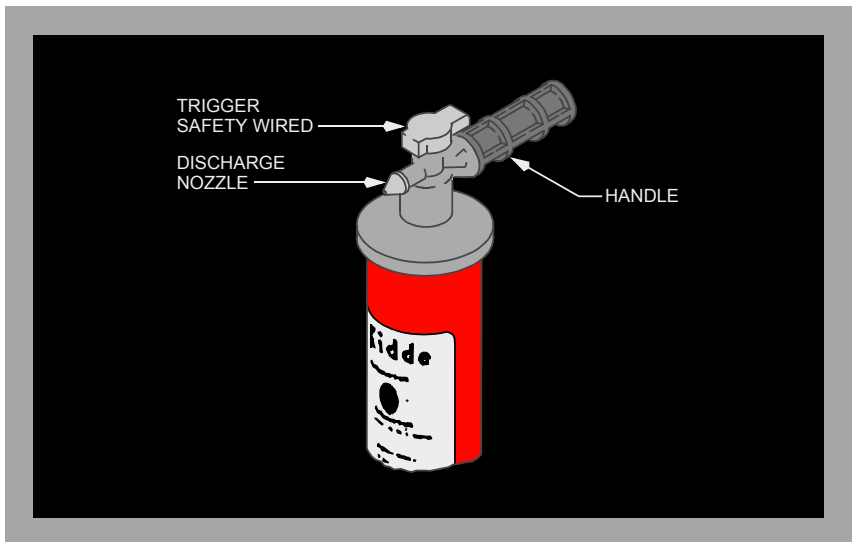

Halon (BCF) Fire Extinguishers

Halon (BCF) fire extinguishers contain a liquefied gas agent under pressure. The pressure indicator shows an acceptable pressure range, a recharge range, and an overcharged range. A safety pin with a pull ring prevents accidental trigger movement. When released the liquefied gas agent vaporizes and extinguishes the fire. The extinguisher is effective on all types of fires, but primarily on electrical, fuel and grease fires.

To use the Halon fire extinguisher:

- remove from stowage
- hold upright and remove ringed safety pin
- aim at base of fire from a distance of six feet and press top lever
- use side to side motion to suppress fire.

BCF Fire Extinguisher (Halon 1211)

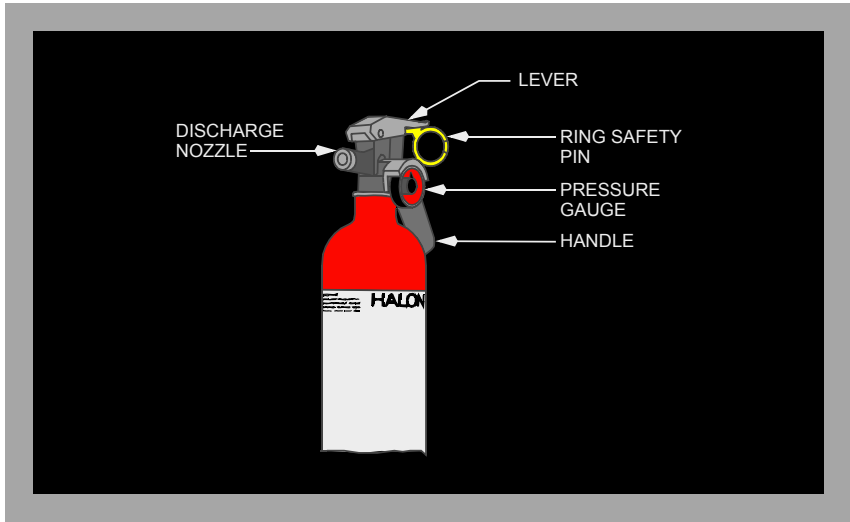

Fire Extinguisher Usage

Each class of fire calls for specialized action. Using the wrong extinguisher may do more harm than good. For your own protection, you should know these basic types, how to use them, and why.

CLASS OF FIRES There are three common classes of fire:		EXTINGUISHER TYPE
CLASS A COMBUSTABLE MATERIALS	- paper, wood, fabric, rubber, certain plastics, etc., where quenching by water is effective.	TYPE A Water (H ₂ O) saturates material and prevents rekindling.
CLASS B FLAMMABLE LIQUIDS	- gasoline, oils, greases, solvents, paints, burning liquids, cooking fats, etc., where smothering action is required.	TYPE B BCF (Halon 1211)
CLASS C LIVE ELECTRICAL	- fires started by short circuit or faulty wiring in electrical, electronic equipment, or fires in motors, switches, galley equipment, etc., where a nonconducting extinguisher agent is required. NOTE: Whenever possible, electrical equipment should be de-energized before attacking a class C fire.	TYPE C BCF (Halon 1211)

WARNING: THE WRONG EXTINGUISHER ON A FIRE COULD DO MORE HARM THAN GOOD. FOR EXAMPLE, **B** **C** RATED EXTINGUISHER IS NOT AS EFFECTIVE AS H₂O ON A CLASS **A** FIRE. WATER ON FLAMMABLE LIQUID FIRES SPREAD THE FIRE. WATER ON A LIVE ELECTRICAL FIRE COULD CAUSE SEVERE SHOCK OR DEATH.

WARNING: The concentrated agent, or the by-products created by the heat of the fire, are toxic when inhaled.

WARNING: If a fire extinguisher is to be discharged in the flight deck, then all crewmembers are to wear oxygen masks and use 100% oxygen with emergency selected.

Emergency Equipment Symbols



CO₂
EXTINGUISHER



WATER
EXTINGUISHER



DRY CHEMICAL
EXTINGUISHER



BCF
EXTINGUISHER



PORTABLE
OXYGEN BOTTLE



PORTABLE
OXYGEN BOTTLE
WITH SMOKE
MASK ATTACHED



DISPOSABLE
OXYGEN MASK



FULL FACE
OXYGEN MASK



SMOKE
HOOD



EXIT PATH
WITHOUT ESCAPE
STRAP



EXIT PATH
WITH ESCAPE
STRAP



EXIT PATH
WITH ESCAPE
SLIDE



LIFE RAFT



EMERGENCY
TRANSMITTER



LIFE
VEST



PROTECTIVE
GLOVES



SMOKE
GOGGLES



CRASH
AXE



MEGAPHONE



BATON



AED



HANDCUFFS



FLASHLIGHT



EMERGENCY
MEDICAL KIT



FIRST AID
KIT



PORTABLE
EXIT LIGHT



RESUSCITATOR

NOTE: SOME SYMBOLS DO NOT APPLY TO ALL CONFIGURATIONS.

Emergency Equipment Locations

YE321 - YE326

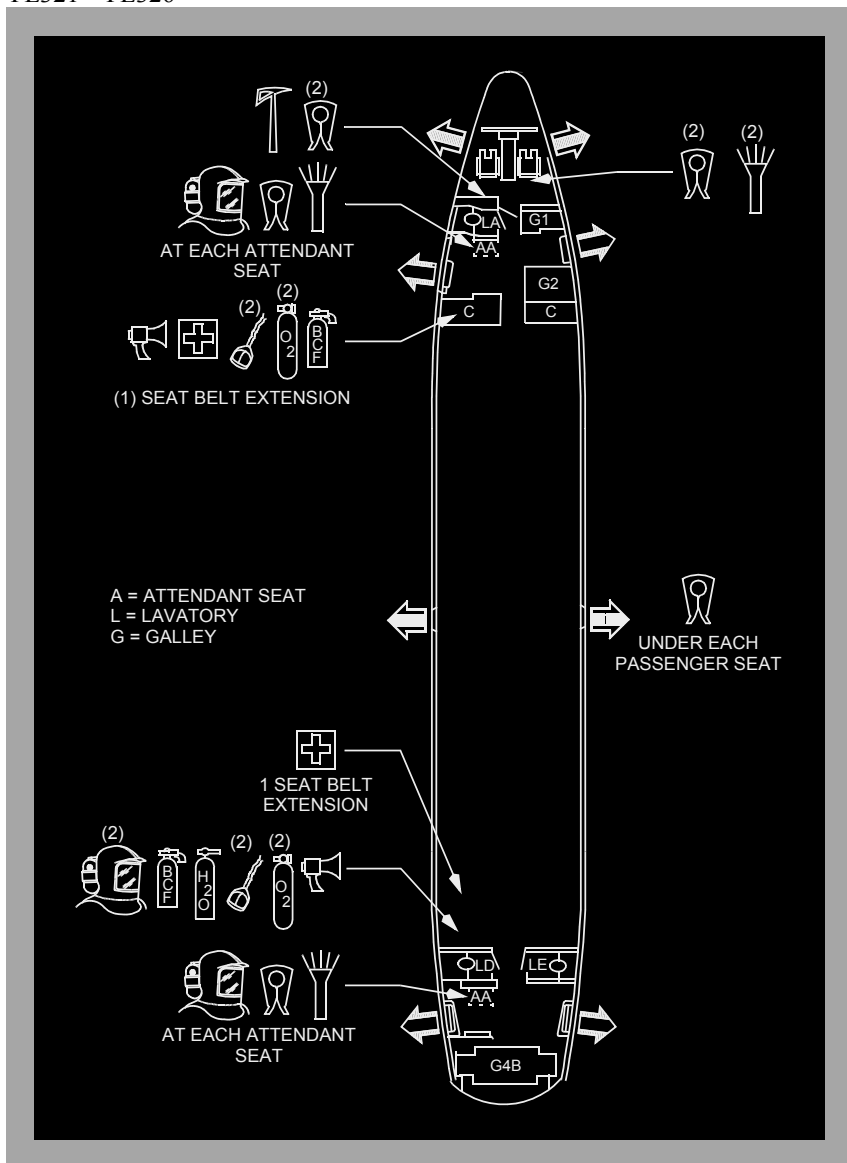

YA371 - YA377

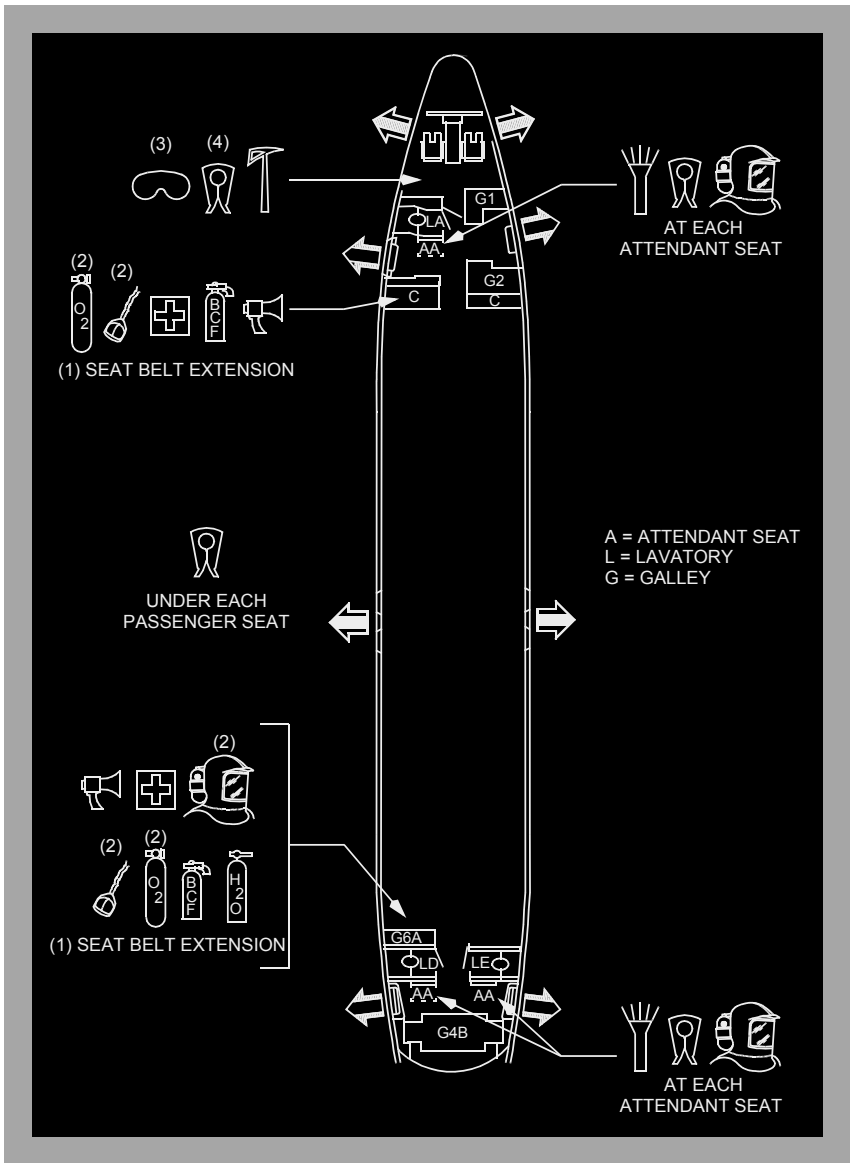

737 Flight Crew Operations Manual

YC201 - YC203

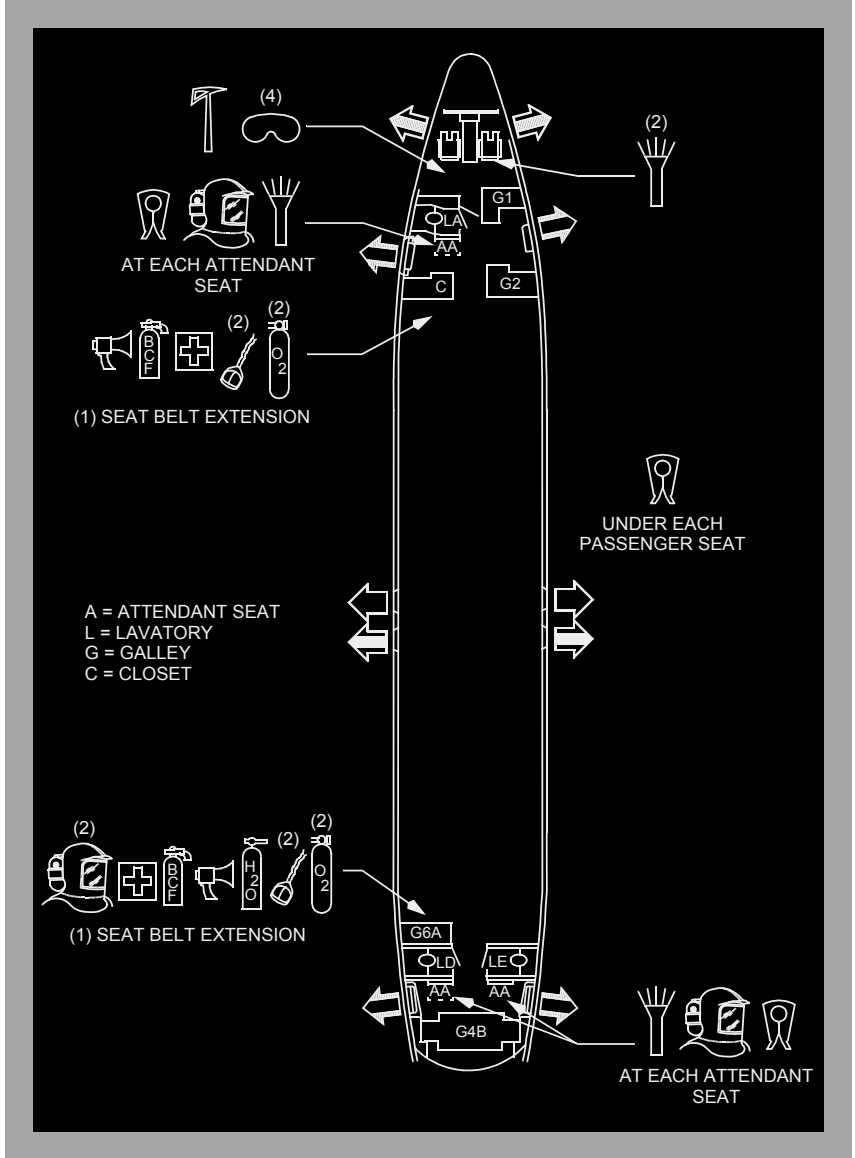

YC206, YC207

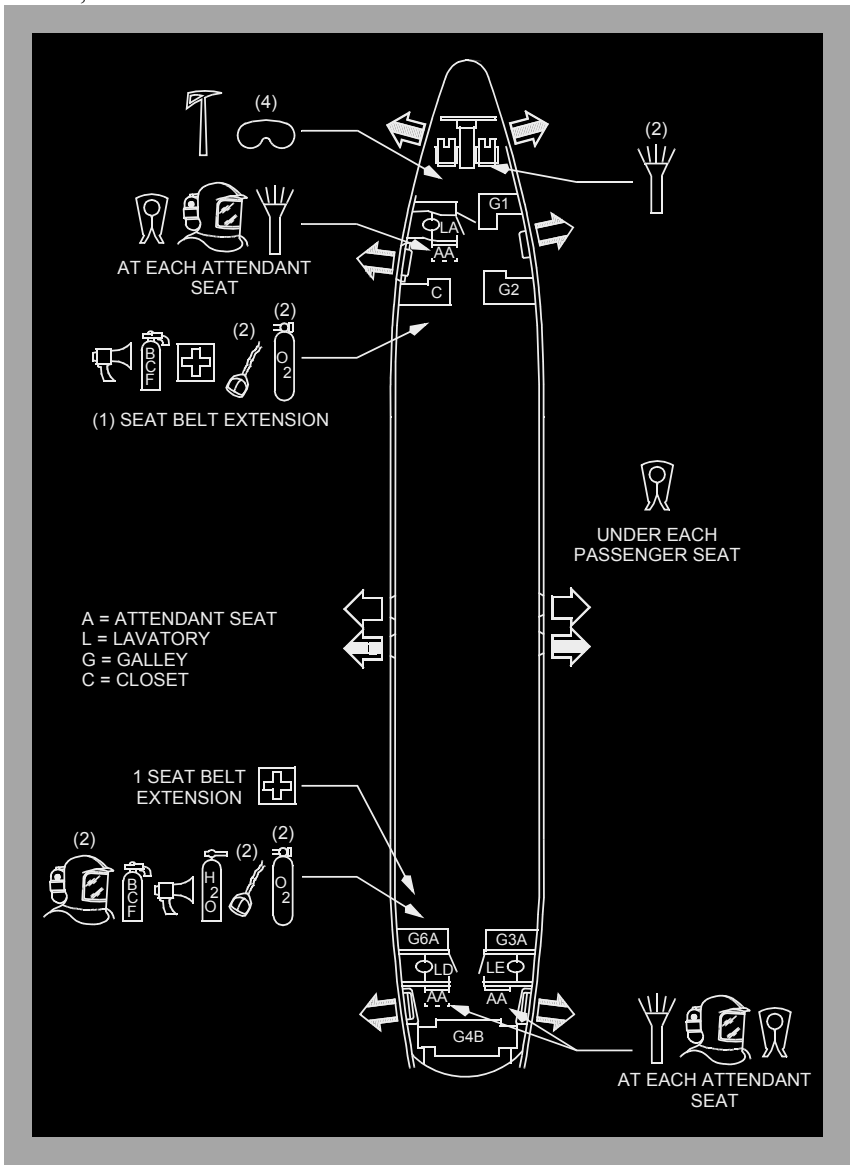

Doors and Windows

The airplane has two passenger entry doors, one cabin door (the flight deck/passenger cabin entry), two service doors and two cargo doors. There is also a center electrical and electronic (E/E) equipment access door and an equipment compartment access door on the bottom of the airplane.

The flight deck number two windows, one on the left and one on the right, can be opened by the flight crew.

Flight Deck Door

The flight deck door meets requirements for resistance to ballistic penetration and intruder entrance. The door opens into the passenger cabin. When closed, the door locks when electrical power is available and unlocks when electrical power is removed. A viewing lens in the door allows observation of the passenger cabin. The door can be manually opened from the flight deck by turning the door handle.

The door incorporates a deadbolt with a key lock on the passenger cabin side. Rotating both concentric deadbolt levers to the locked (horizontal) position prevents the passenger cabin key from unlocking the door. Rotating only the forward deadbolt lever to locked allows the key to unlock the door.

The flight deck access system consists of an emergency access panel, chime module, three position Door Lock selector, two indicator lights, and an Access System switch. The emergency access panel includes a six button keypad for entering the numeric emergency access code along with red, amber, and green lights. The red light illuminates to indicate the door is locked. When the correct emergency access code is entered, the amber light illuminates. The green light illuminates to indicate the door is unlocked.

Two indicator lights and a three position Door Lock selector are located on the aisle stand. Illumination of the amber LOCK FAIL light indicates the door lock has failed or the Access System switch is in the OFF position.

The emergency access code is used to gain access to the flight deck in case of pilot incapacitation. A flight deck chime and illumination of the amber AUTO UNLK light indicates the correct emergency access code has been entered and the door is programmed to unlock after a time delay. Selecting the DENY position on the Door Lock selector denies entry and prevents further keypad entry for several minutes. To allow entry, the selector is turned to the UNLKD position which unlocks the door while held in that position. If the emergency access code is entered and the pilot takes no action, the door unlocks after expiration of the time delay. Before the door unlocks, the chime sounds continuously and the AUTO UNLK light flashes.

By pressing "1" then "ENT" keys on the emergency access panel, the flight deck chime will sound (if programmed).

The door incorporates two pressure sensors that unlock the decompression panels in the event pressurization is lost. The decompression panels have manual release pins. Pulling the pins frees the panels allowing egress in the event the door is jammed.

Flight Deck Number Two Windows

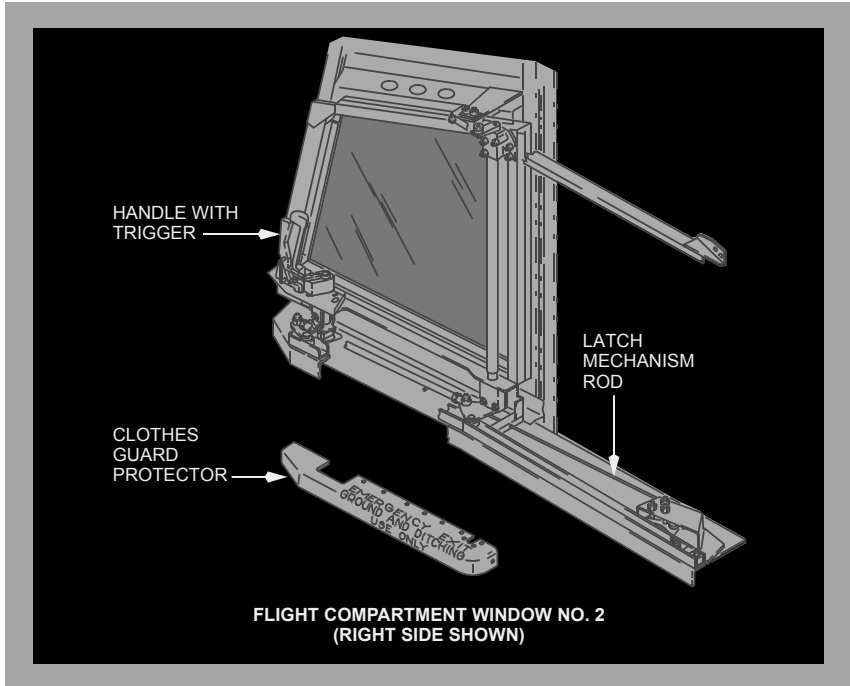

The flight deck number two windows can be opened on the ground or in flight and can be used for emergency evacuation. To open the window, depress the trigger and turn the handle back and inboard. After the window moves inboard, move it back until it locks in the open position.

To close the window, it must first be unlocked. Pull forward on the latch mechanism rod to unlock the window. Depress the trigger and move the window forward until the handle can be turned forward and outboard. When the trigger is released, the window latches.

Only the first officer's window number two window can be opened from outside the airplane.

Lower Cargo Compartments

The lower cargo compartments are designed and constructed to satisfy FAA category Class C compartment requirements. This means the compartments are designed to completely confine a fire without endangering the safety of the airplane or its occupants. The compartments are sealed and pressurized but do not have fresh air circulation and temperature control as do the upper passenger compartments.

There are two cargo compartment doors on the lower right side of the fuselage. Both are plug type, inward opening pressure doors, hinged at their upper edges and operated manually from either inside or outside the airplane. Except for slight difference in shape, both doors are similar in design and operation. The door is locked closed by two latches. Each door has a balance mechanism which creates door–open force slightly more than equal to the weight of the door. The door can therefore, with little effort, be swung open. The door can be closed easily by pulling a lanyard attached to the door, grasping the handle and closing the door.

A pressure equalization valve is in the aft bulkhead of each compartment. The valves let only enough air flow into or out of the cargo compartments to keep the pressures nearly the same as the cabin pressure.

Blowout panels in the lower cargo compartments provide pressure relief at a greater rate than the pressure equalization valve in case the airplane pressurization is lost.

YA371 - YA373, YC201, YC202, YE321 - YE325

WARNING: With the cargo sliding carpet loading system installed, failure to fully extend the baggage handling system bulkhead before airplane dispatch may interfere with airplane decompression and the smoke detection and fire suppression system.

Emergency Escape

Emergency escape information included in this chapter includes:

- emergency evacuation routes
- flight deck windows
- escape slides
- escape straps
- emergency exit doors

Emergency Evacuation Routes

YA371 - YA377, YE321 - YE326

Emergency evacuation may be accomplished through four entry/service doors and two overwing escape hatches. Flight deck crew members may evacuate the airplane through two sliding flight deck windows.

YC201 - YC207

Emergency evacuation may be accomplished through four entry/service doors and four overwing escape hatches. Flight deck crew members may evacuate the airplane through two sliding flight deck windows.

Emergency Evacuation Routes

YA371 - YA377, YE321 - YE326

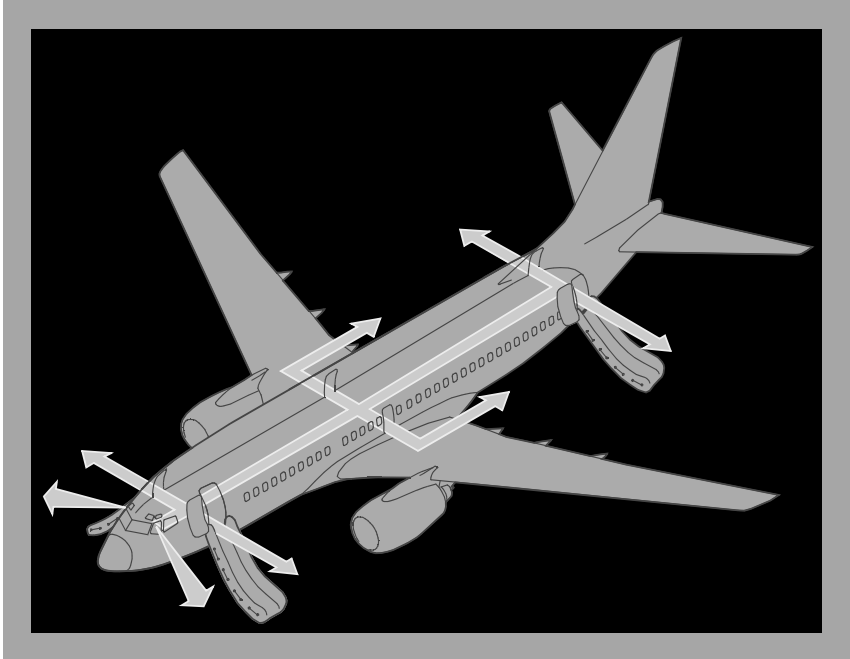

YC201 - YC207

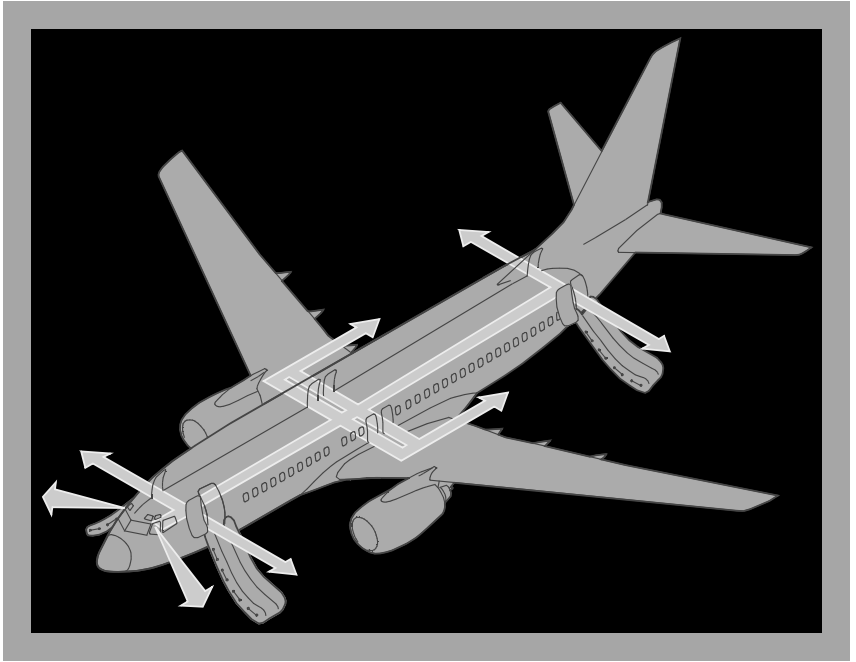

Flight Deck Window Emergency Egress

If the flight deck number two windows must be used for emergency egress, use the following procedure:

- open the window
- open the escape strap compartment (above and aft of window)
- pull on the escape strap to ensure it is securely attached
- throw the strap out the window
- sit on the window sill with upper body outside
- exit in accordance with the following illustration.

CAUTION: Ensure the escape strap is securely fastened to the airplane.

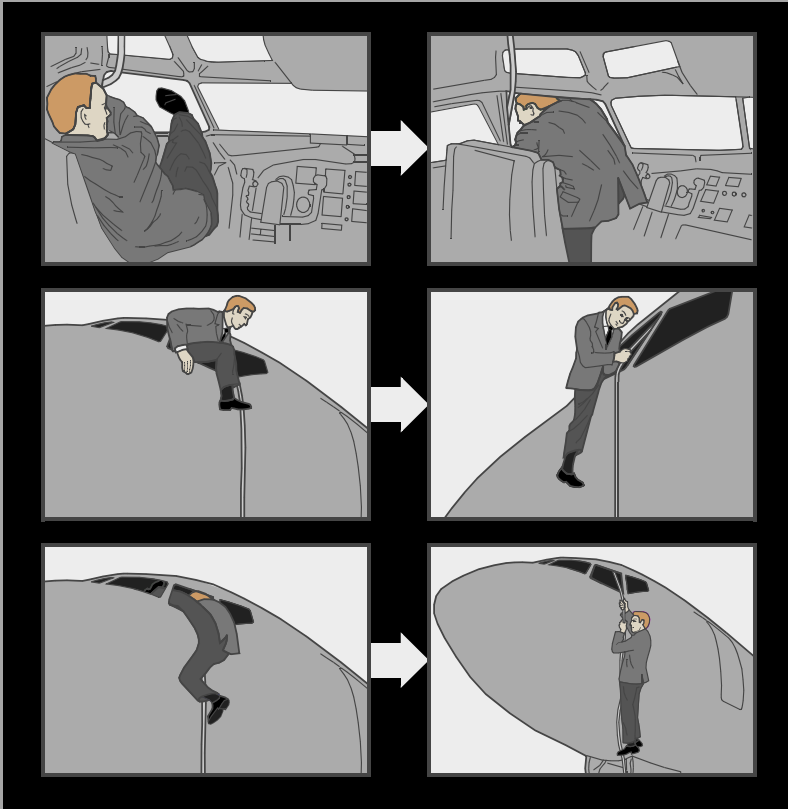

The above illustrated method of departure would probably be the easiest for most crewmembers. This technique is difficult and should be used only in extreme emergency.

Escape Slide Detachment Handle

The slide has not been certified to be part of the water landing emergency equipment. In a water environment, the slide may not properly inflate when deployed. If the deployed slide is recognized to be a potential obstruction to egress, a detachment handle is provided near the top of the slide. This handle is protected by a cover and is placarded. The escape slide is detached from the airplane by pulling the detachment handle. Once detached from the door sill, the slide is tethered to the door sill by a lanyard. A properly inflated slide could be buoyant, and useful as a flotation device for passengers in the water. Hand grips are positioned along the sides of the slide.

Escape Slide Detachment Handle

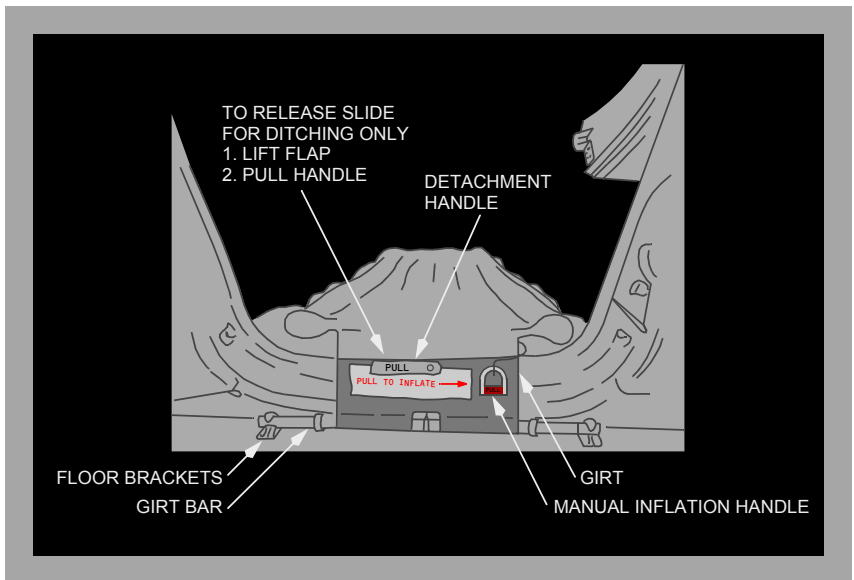

Escape Straps

YA371 - YA377, YE321 - YE326

Escape straps are installed above each emergency exit door frame. The escape doors must be opened to expose the straps. One end of the strap is attached to the door frame. The remainder of the strap is stowed in a tube extending into the cabin ceiling. To use, the strap is pulled free from its stowage and attached to a ring on the top surface of the wing. The escape strap can be used as a hand hold in a ditching emergency for passengers to walk out on the wing and step into a life raft.

YC201 - YC207

Escape straps are installed above each aft emergency exit door frame. The escape doors must be opened to expose the straps. One end of the strap is attached to the door frame. The remainder of the strap is stowed in a tube extending into the cabin ceiling. To use, the strap is pulled free from its stowage and attached to a ring on the top surface of the wing. The escape strap can be used as a hand hold in a ditching emergency for passengers to walk out on the wing and step into a life raft.

737 Flight Crew Operations Manual

YA371 - YA377, YE321 - YE326

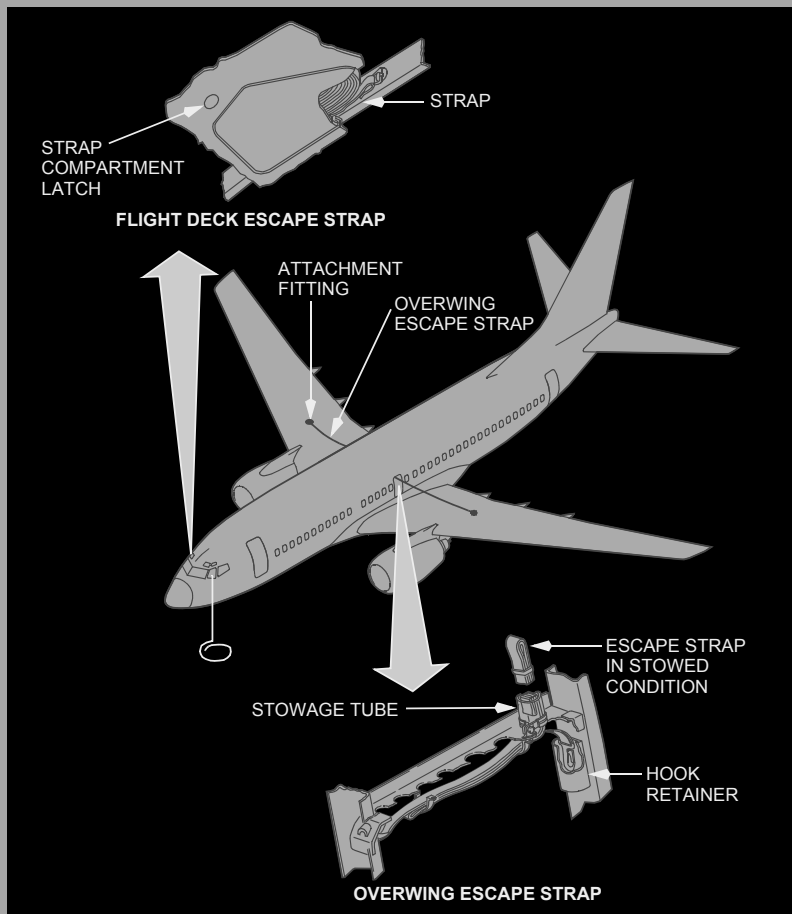

YC201 - YC207

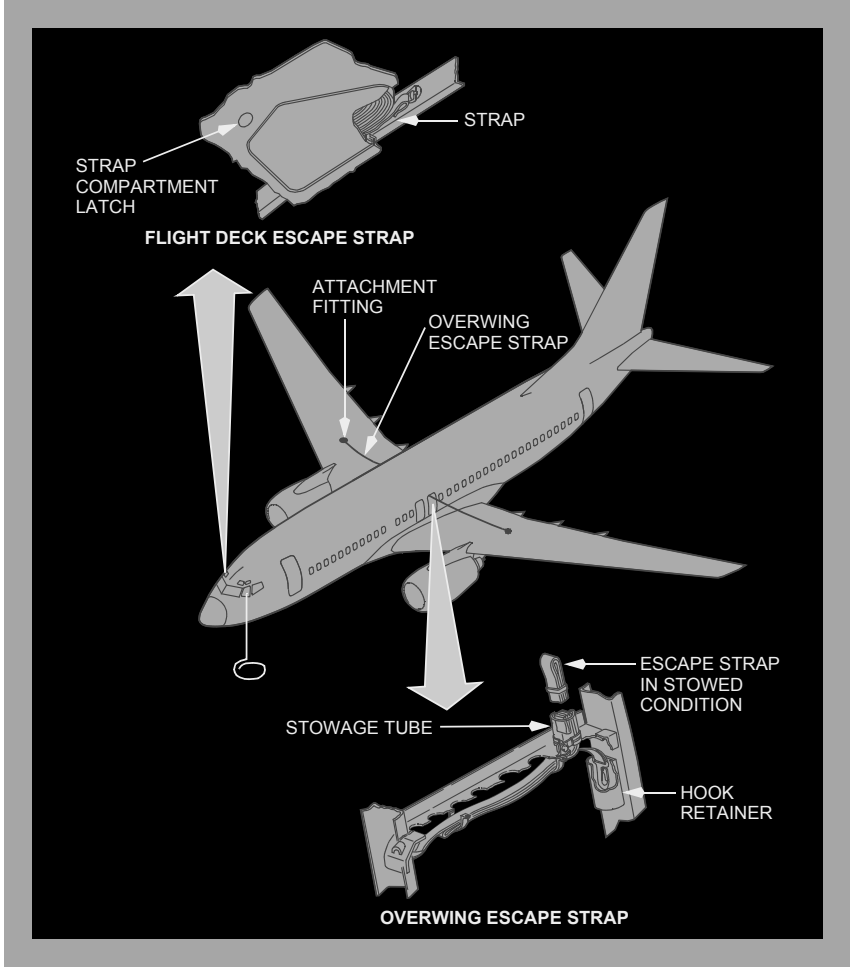

Emergency Exit Doors

YA371 - YA377, YE321 - YE326

Two Type III emergency exits are located in the passenger cabin over the wings. These are canopy-type doors and are held in place by mechanical locks and airplane cabin pressure.

YC201 - YC207

Four Type III emergency exits are located in the passenger cabin over the wings. These are canopy-type doors and are held in place by mechanical locks and airplane cabin pressure.

The doors can be opened from inside or outside of the airplane by a spring-loaded handle at the top of the door. The 28 Volt DC flight lock system is designed to ensure that the flight lock will automatically lock during takeoff, in-flight, and landing and unlock on the ground to allow for opening of the door in emergency situations. Commands for the flight lock to lock and unlock are dependent upon engine speed, thrust lever position, air/ground mode status, and the open/closed status of the doors.

The overwing emergency exits lock when:

- three of the four Entry/Service doors are closed and
- either engine is running and
- the airplane air/ground logic indicates that the airplane is in the air or both thrust levers are advanced.

The overwing emergency exits unlock when any one of the above conditions is not met or DC power is lost.

The LEFT OVERWING and/or RIGHT OVERWING warning lights, DOORS annunciator, and MASTER CAUTION light illuminate when an emergency exit door is not fully closed and locked or when the flight lock is not engaged, either during the takeoff roll or in-flight.

If a flight lock has failed locked or a fault is detected the PSEU light, the OVERHEAD annunciator, and the MASTER CAUTION lights illuminate. These indications are inhibited from takeoff until 30 seconds after the airplane is in the ground mode. When the doors are latched and locked and the flight lock is operating properly none of these lights will illuminate.

YA371 - YA377, YE321 - YE326

**EMERGENCY EXIT
ONLY**

PUSH TO OPEN
DOOR OPENS OUT AND UP
AUTOMATICALLY

⚠ WARNING



DOOR SWINGS
OUT AND UP
HOLD YOUR
KNEE AGAINST
DOOR WHILE
OPENING OR
SERIOUS
INJURY CAN
OCCUR

EXTERIOR PLACARDS

EXTERIOR OVERWING
EMERGENCY EXIT
PUSH PANEL

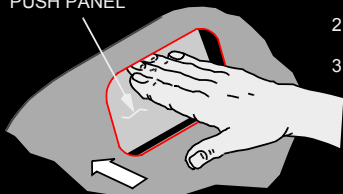

TO OPEN DOOR FROM THE OUTSIDE:

1. HOLD KNEE AGAINST LOWER PORTION OF DOOR.
2. PUSH IN EXTERIOR OVERWING EMERGENCY EXIT PUSH PANEL.
3. DOOR OPENS OUT AND UP AUTOMATICALLY.

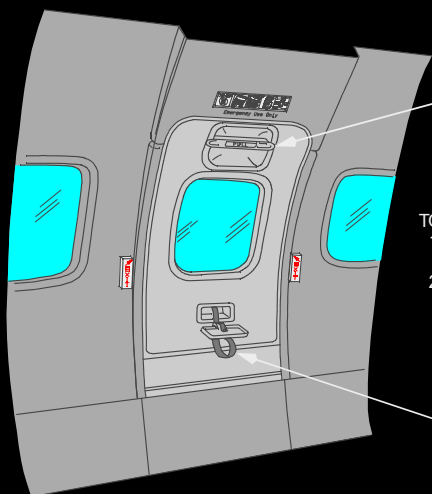

INTERIOR HANDLE

TO OPEN DOOR FROM THE INSIDE:

1. PULL INTERIOR HANDLE DOWN AND INWARD.
2. DOOR OPENS OUT AND UP AUTOMATICALLY.

CLOSING STRAP
PANEL SHOWN OPEN.

YC201 - YC207

**EMERGENCY EXIT
ONLY**

PUSH TO OPEN
DOOR OPENS OUT AND UP
AUTOMATICALLY

⚠ WARNING



DOOR SWINGS
OUT AND UP
HOLD YOUR
KNEE AGAINST
DOOR WHILE
OPENING OR
SERIOUS
INJURY CAN
OCCUR

EXTERIOR PLACARDS

EXTERIOR OVERWING
EMERGENCY EXIT
PUSH PANEL

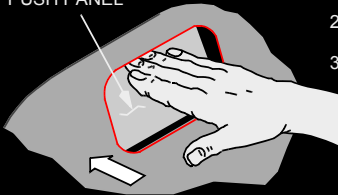

- TO OPEN DOOR FROM THE OUTSIDE:
1. HOLD KNEE AGAINST LOWER PORTION OF DOOR.
 2. PUSH IN EXTERIOR OVERWING EMERGENCY EXIT PUSH PANEL.
 3. DOOR OPENS OUT AND UP AUTOMATICALLY.

INTERIOR HANDLE

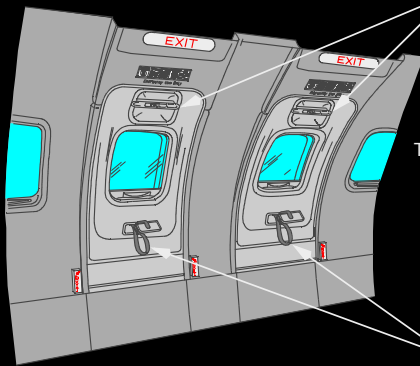

- TO OPEN DOOR FROM THE INSIDE:
1. PULL INTERIOR HANDLE DOWN AND INWARD.
 2. DOOR OPENS OUT AND UP AUTOMATICALLY.

CLOSING STRAP
PANEL SHOWN OPEN.

Pilot Seat Adjustment

Adjust the seat position with the appropriate controls to obtain the optimum eye reference position. Use the handhold above the forward window to assist. The following sight references are used:

- Sight along the upper surface of the glareshield with a small amount of the airplane nose structure visible (A)
- Sight over the control column (in the neutral position) until the bottom edge of the outboard display unit is visible (B).

Pilot Seat Adjustment

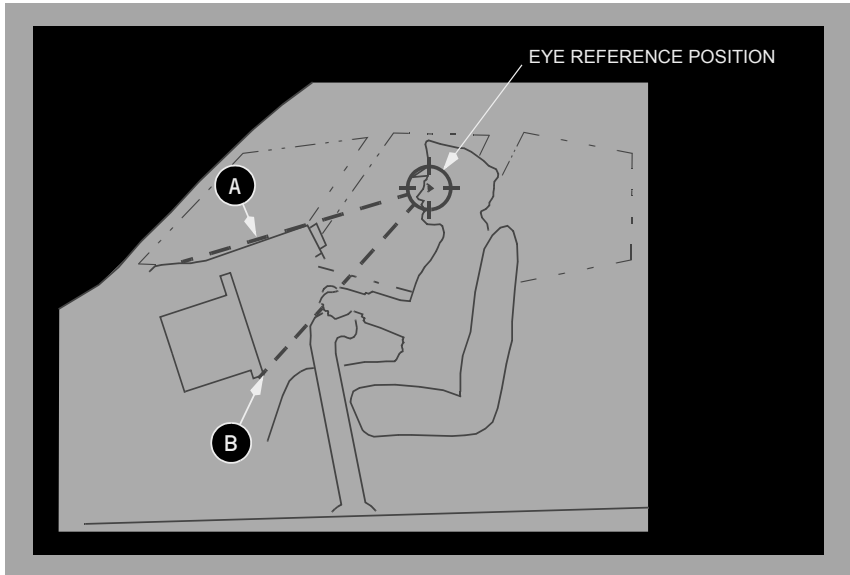

Galleys

Galleys are located in the passenger cabin to provide convenient and rapid service to the passengers. Generally, they are installed in the cabin adjacent to the forward and aft galley service doors.

In general the equipment of the galley unit consists of the following main items:

- high speed ovens
- hot beverage containers
- hot cup receptacles
- refrigeration and main storage compartments.

Electrical control panel switches and circuit breakers to operate the above equipment are conveniently located within the galley work area. Storage space, miscellaneous drawers and waste containers are also integrated in the galley units.

Electrical Power

Electricity for the galleys is 115V AC supplied from the airplane transfer buses and controlled by a switch on the overhead panel. Circuit breakers are located in the lower E/E bay as part of the power distribution panels.

Water Service

Water is supplied to the galleys from the airplane pressurized water system and, in an emergency, may be shut off at the galley.

Water System

The potable airplane water system is supplied from a single tank located behind the aft cargo compartment. Fresh water is supplied to the galleys and lavatory sinks.

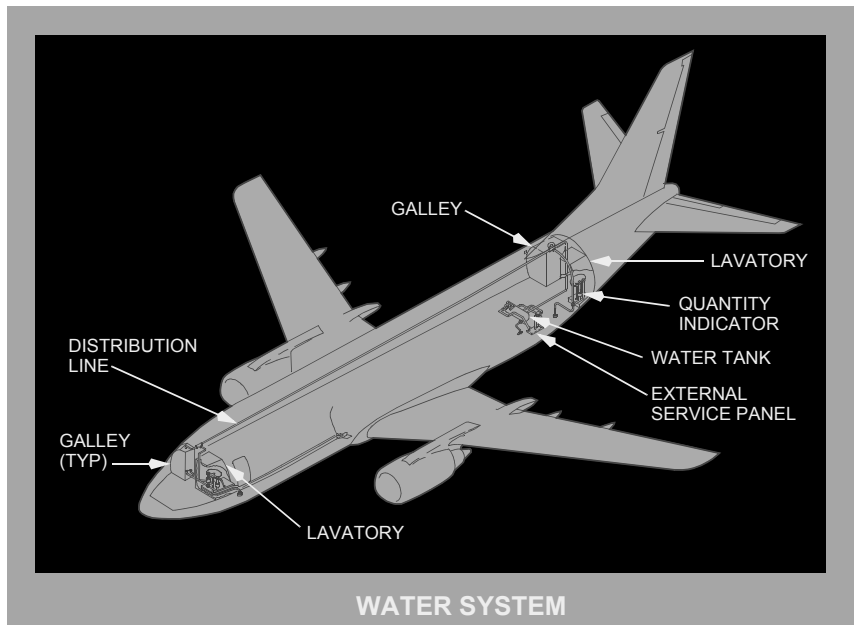

Quantity Indication and System Operation

A quantity indicator is located on the attendant panel. The system is pressurized by engine bleed air or by the water system air compressor. Shutoff valves are located on each galley and below the sink in each lavatory. The drain position of this valve is used to drain all water overboard. Normally, the drain shutoff valves are ON.

Hot Water

Hot and cold water is available in all lavatories. The water heater is located below the lavatory sink. When emptied, it heats a new water charge in four minutes. An amber light is ON when the heater is operating normally. The heater has an overheat switch which turns off the heating element if an excess temperature is reached. The heater may be turned off at any time by using a manual switch on the heater. Cold water is supplied at the galleys.

Servicing

The system is serviced from an exterior panel located on the bottom right side of the aft fuselage. Pressure filling is required. Waste water from the galleys and lavatory wash basins is drained overboard through two heated drain masts. The drain masts are on the bottom of the fuselage; one forward and one aft.



Controls and Indicators **2.10.1**

- Bleed Air Controls and Indicators 2.10.1
- Air Conditioning Controls and Indicators 2.10.5
- Equipment Cooling Panel 2.10.12
- Cabin Altitude Panel 2.10.13
- Cabin Pressurization Panel 2.10.14

Bleed Air System Description **2.20.1**

- Introduction 2.20.1
- Engine Bleed System Supply 2.20.1
 - Engine Bleed Air Valves 2.20.1
 - Bleed Trip Sensors 2.20.1
 - Duct Pressure Transmitters 2.20.2
 - Isolation Valve 2.20.2
 - External Air Connection 2.20.2
 - APU Bleed Air Valve 2.20.2
 - DUAL BLEED Light 2.20.2
 - Bleed Air System Schematic 2.20.3
- Wing-Body Overheat 2.20.5
 - Wing-Body Overheat Ducts and Lights 2.20.5

Air Conditioning System Description **2.30.1**

- Introduction 2.30.1
- Air Conditioning Pack 2.30.1
 - Airflow Control 2.30.1
 - Ram Air System 2.30.2
 - Cooling Cycle 2.30.2
 - Air Mix Valves 2.30.2
 - Air Conditioning Pack Schematic 2.30.3

Air Conditioning Distribution	2.30.3
Flight Deck	2.30.4
Passenger Cabin	2.30.4
Recirculation Fan	2.30.4
Equipment Cooling	2.30.4
Forward Cargo Compartment	2.30.5
Conditioned Air Source Connection	2.30.5
Air Conditioning Distribution Schematic	2.30.6
Introduction	2.31.1
Air Conditioning Pack	2.31.1
Airflow Control	2.31.1
Ram Air System	2.31.2
Cooling Cycle	2.31.2
Pack Temperature Control	2.31.2
Air Conditioning Pack Schematic	2.31.3
Zone Temperature Control	2.31.4
Zone Temperature Control Modes	2.31.4
Unbalanced Pack Temperature Control Mode	2.31.4
Standby Pack Average Temperature	2.31.5
Fixed Cabin Temperature	2.31.5
Air Conditioning Distribution	2.31.5
Flight Deck	2.31.5
Passenger Cabin	2.31.5
Recirculation Fan	2.31.6
Equipment Cooling	2.31.6
Forward Cargo Compartment	2.31.6
Conditioned Air Source Connection	2.31.6
Air Conditioning Distribution Schematic	2.31.7
Pressurization System Description	2.40.1
Introduction	2.40.1
Pressure Relief Valves	2.40.1
Cabin Pressure Controller	2.40.1
Cabin Pressure Control System Schematic	2.40.2



737 Flight Crew Operations Manual

Pressurization Outflow	2.40.2
Outflow Valve	2.40.3
Overboard Exhaust Valve	2.40.3
Pressurization Outflow Schematic	2.40.4
Auto Mode Operation	2.40.5
Flight Path Events – Auto Mode	2.40.7
Manual Mode Operation	2.40.8



Intentionally
Blank

Bleed Air Controls and Indicators

YA371 - YA377, YE321 - YE326

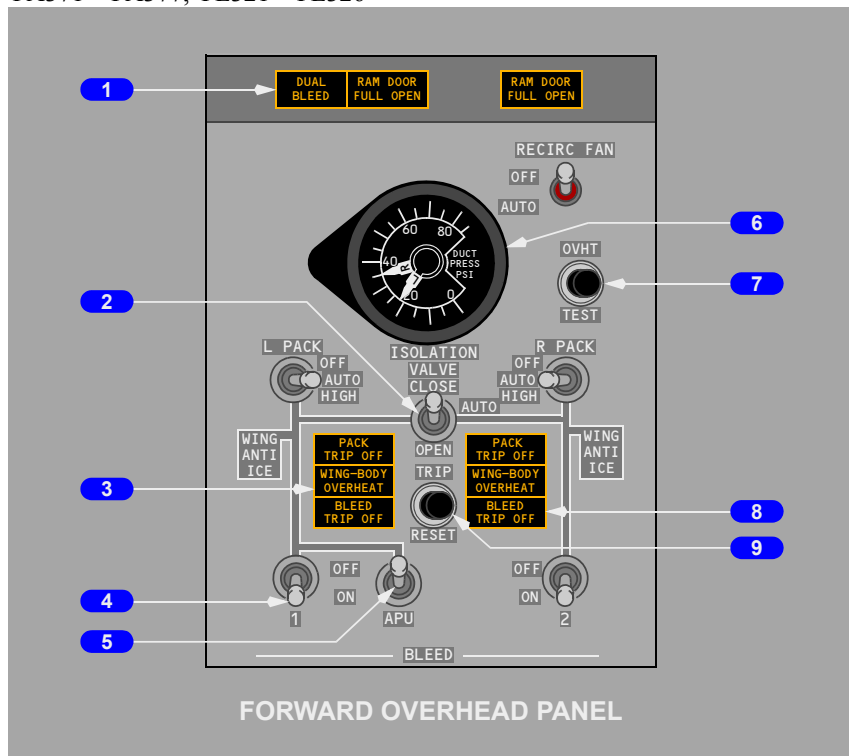

FORWARD OVERHEAD PANEL

YC201 - YC207

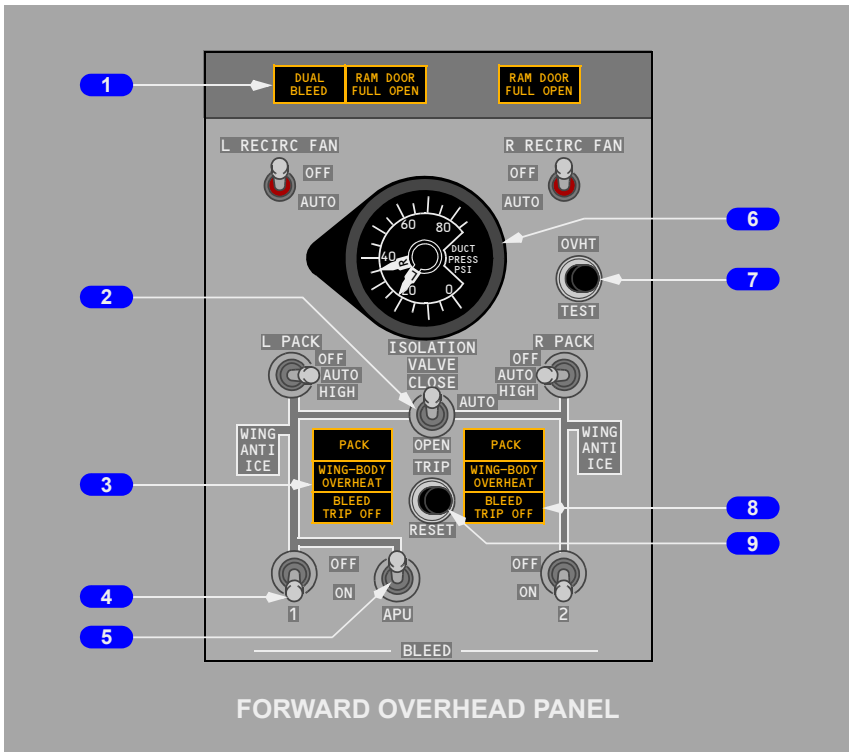

1 DUAL BLEED Light

Illuminated (amber) – APU bleed air valve open and engine No. 1 BLEED air switch ON, or engine No. 2 BLEED air switch ON, APU bleed air valve and isolation valve open.

2 ISOLATION VALVE Switch

CLOSE – closes isolation valve.

AUTO –

- closes isolation valve if both engine BLEED air switches are ON and both air conditioning PACK switches are AUTO or HIGH
- opens isolation valve automatically if either engine BLEED air or air conditioning PACK switch positioned OFF.

OPEN – opens isolation valve.

737 Flight Crew Operations Manual

3 WING–BODY OVERHEAT Light

Illuminated (amber) –

- left light indicates overheat from bleed air duct leak in left engine strut, left inboard wing leading edge, left air conditioning bay, keel beam or APU bleed air duct
- right light indicates overheat from bleed air duct leak in right engine strut, right inboard wing leading edge or right air conditioning bay.

4 Engine BLEED Air Switches

OFF – closes engine bleed air valve.

ON – opens engine bleed air valve when engines are operating.

5 APU BLEED Air Switch

OFF – closes APU bleed air valve.

ON – opens APU bleed air valve when APU is operating.

6 Bleed Air DUCT PRESSURE Indicator

Indicates pressure in L and R (left and right) bleed air ducts.

7 Wing–Body Overheat (OVHT) TEST Switch

Push –

- tests wing–body overheat detector circuits
- illuminates both WING–BODY OVERHEAT lights.

8 BLEED TRIP OFF Light

Illuminated (amber) – excessive engine bleed air temperature or pressure

- related engine bleed air valve closes automatically
- requires reset.

9 TRIP RESET Switch

YA371 - YA377, YE321 - YE326

Push (if fault condition is corrected) –

- resets BLEED TRIP OFF, PACK TRIP OFF and DUCT OVERHEAT lights
- related engine bleed valve opens, or related pack valve opens, or related air mix valve opens
- lights remain illuminated until reset.

9 TRIP RESET Switch

YC201 - YC207

Push (if fault condition is corrected) –

- resets BLEED TRIP OFF, PACK and ZONE TEMP lights
- related engine bleed valve opens, or related pack valve opens, or related air mix valve opens
- lights remain illuminated until reset.

737 Flight Crew Operations Manual

Air Conditioning Controls and Indicators

YA371 - YA377, YE321 - YE326

YE321 - YE326

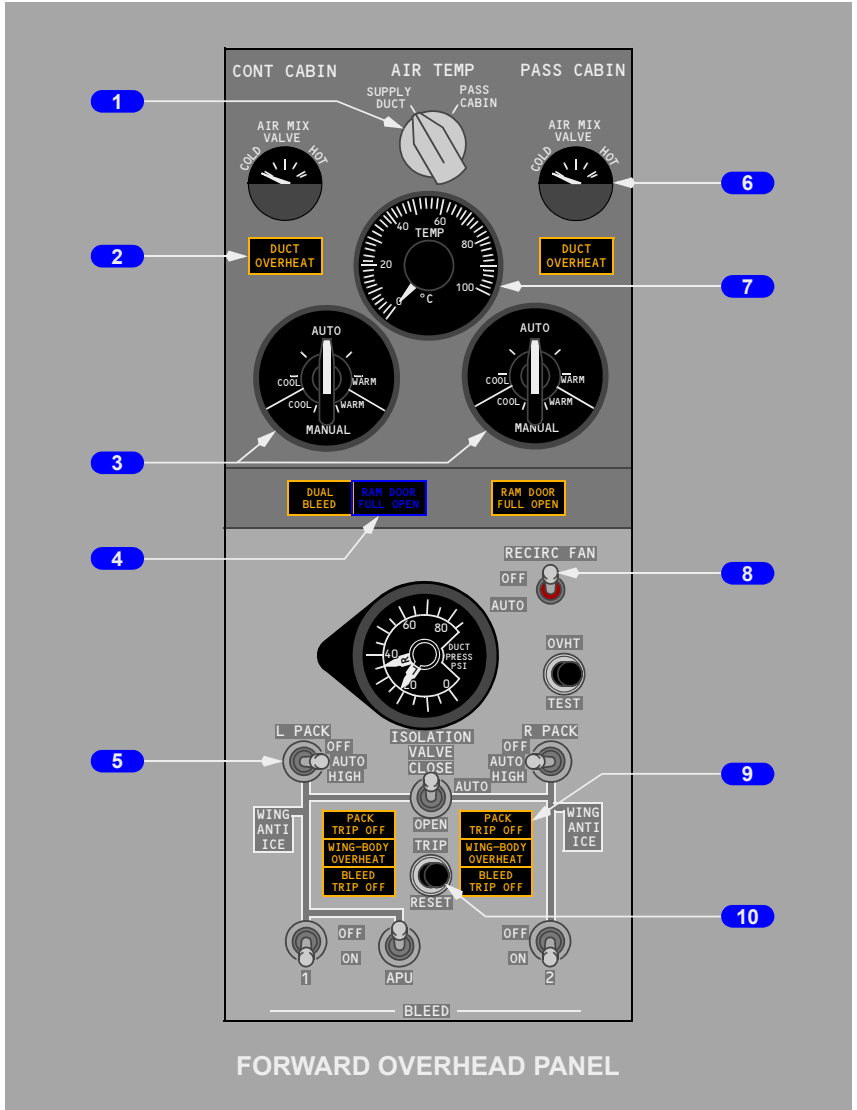

YA371 - YA377

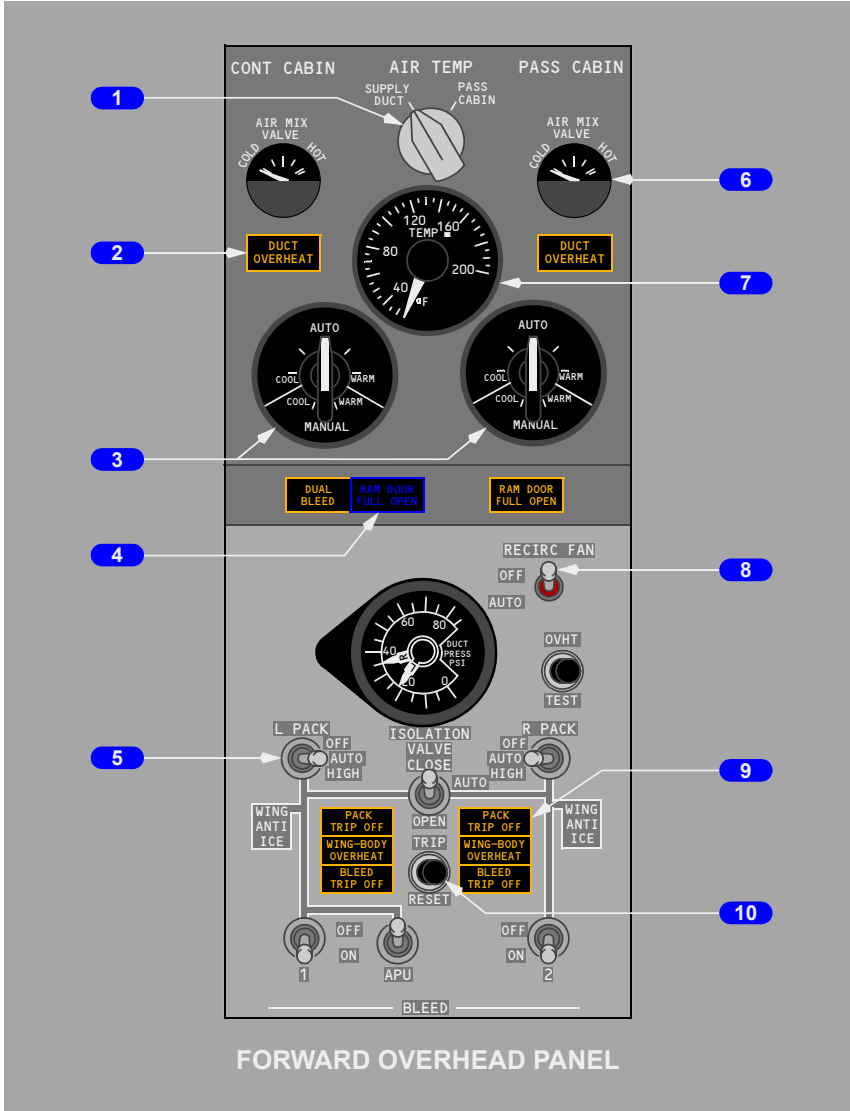

1 AIR Temperature (TEMP) Source Selector

SUPPLY DUCT – selects main distribution supply duct sensor for TEMP indicator.

PASS CABIN – selects passenger cabin sensor for TEMP indicator.

2 DUCT OVERHEAT Light

Illuminated (amber) –

- bleed air temperature in related duct exceeds limit
- air mix valves drive full cold
- requires reset.

3 Control (CONT) CABIN and Passenger (PASS) CABIN Temperature Selector

AUTO – automatic temperature controller controls passenger cabin or flight deck temperature as selected.

MANUAL – air mix valves controlled manually. Automatic temperature controller bypassed.

4 RAM DOOR FULL OPEN Light

Illuminated (blue) – indicates ram door in full open position.

5 Air Conditioning PACK Switch

OFF – pack signalled OFF.

AUTO –

- with both packs operating, each pack regulates to low flow
- with one pack operating, operating pack regulates to high flow in flight with flaps up
- when operating one pack from APU (both engine BLEED air switches OFF), regulates to high flow.

HIGH –

- pack regulates to high flow
- provides maximum flow rate on ground with APU BLEED air switch ON.

6 AIR MIX VALVE Indicator

Indicates position of air mix valves:

- controlled automatically with related temperature selector in AUTO
- controlled manually with related temperature selector in MANUAL.

7 Air Temperature (TEMP) Indicator

Indicates temperature at location selected with AIR TEMP source selector.

8 Recirculation (RECIRC) FAN Switch

OFF - fan signalled off.

AUTO – fan signalled on except when both packs operating with either PACK switch in HIGH.

9 PACK TRIP OFF Light

Illuminated (amber) –

- indicates pack temperature has exceeded limits
- related pack valve automatically closes and mix valves drive full cold
- requires reset.

10 TRIP RESET Switch

Push (if fault condition is corrected) –

- resets BLEED TRIP OFF, PACK TRIP OFF and DUCT OVERHEAT lights
- related engine bleed air valves open, or related pack valves open, or related air mix valves open
- lights remain illuminated until reset.

737 Flight Crew Operations Manual

YC201 - YC207

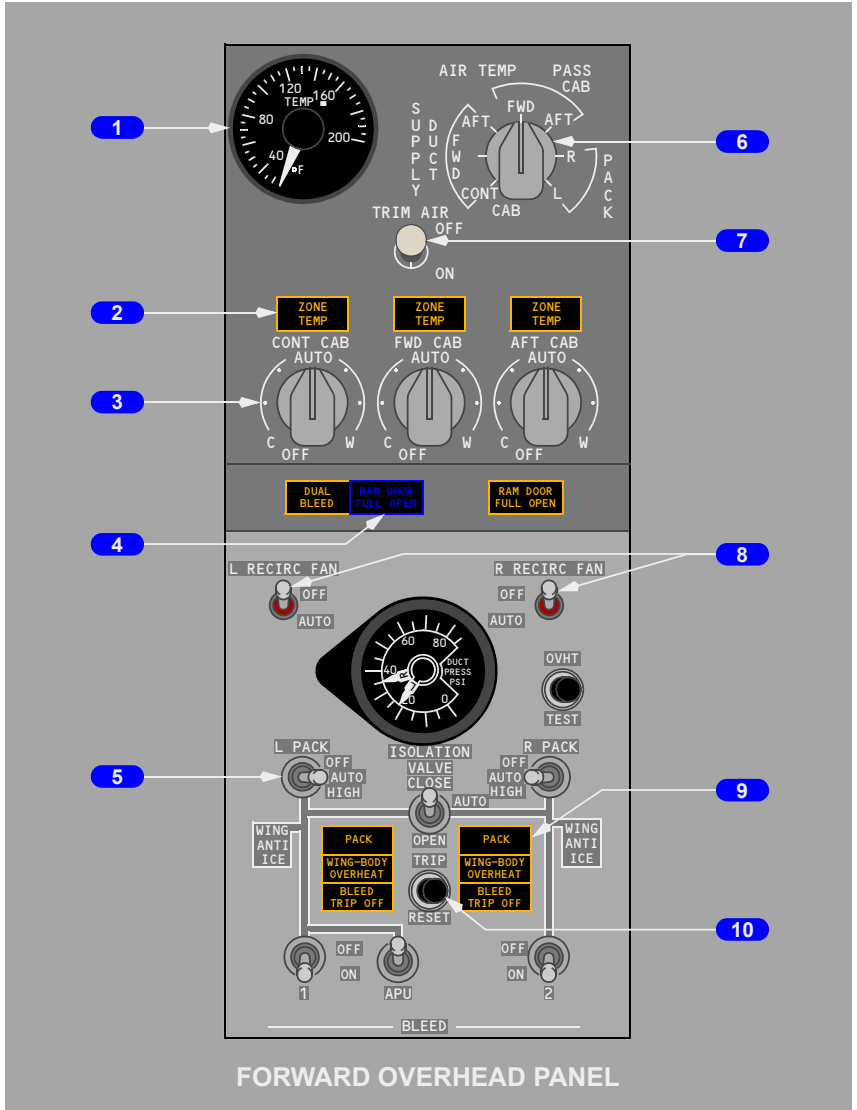

1 Air Temperature (TEMP) Indicator

Indicates temperature at location selected with AIR TEMP source selector.

2 ZONE TEMP Lights

Illuminated (amber) –

- CONT CAB indicates a duct temperature overheat or failure of the flight deck primary and standby temperature control
- FWD CAB or AFT CAB indicates duct temperature overheat.

During Master Caution light recall:

- CONT CAB indicates failure of the flight deck primary or standby temperature control
- either FWD CAB or AFT CAB indicates failure of the associated zone temperature control
- lights will extinguish when Master Caution is reset.

3 Temperature Selector

AUTO – provides automatic temperature control for the associated zones. Rotating the control toward C (cool) or W (warm) manually sets the desired temperature.

OFF – closes the associated trim air modulating valve.

4 RAM DOOR FULL OPEN Light

Illuminated (blue) – indicates ram door in full open position.

5 Air Conditioning PACK Switch

OFF – pack signalled OFF.

AUTO –

- with both packs operating, each pack regulates to low flow
- with one pack operating, operating pack regulates to high flow in flight with flaps up
- when operating one pack from APU (both engine BLEED air switches OFF), regulates to high flow.

HIGH –

- pack regulates to high flow
- provides maximum flow rate on ground with APU BLEED air switch ON.

6 AIR Temperature (TEMP) Source Selector

SUPPLY DUCT – selects appropriate zone supply duct temperature

PASS CAB – selects forward or aft passenger cabin temperature

PACK - selects left or right pack temperatures.

737 Flight Crew Operations Manual

7 TRIM AIR Switch

ON - trim air pressure regulating and shutoff valve signaled open.

OFF - trim air pressure regulating and shutoff valve signaled closed.

8 Recirculation (RECIRC) FAN Switches

OFF - fan signalled off.

AUTO –

- in-flight –
 - the left recirculation fan operates if both packs are operating unless either PACK switch is in HIGH
 - the right recirculation fan operates if both packs are operating unless both PACK switches are in HIGH.
- on the ground –
 - the left recirculation fan operates unless both PACK switches are in HIGH
 - the right recirculation fan operates even if both PACK switches are in HIGH.

9 PACK Light

Illuminated (amber) –

- indicates pack trip off or failure of both primary and standby pack controls
- during Master Caution recall, indicates failure of either primary or standby pack control. Extinguishes when Master Caution is reset

10 TRIP RESET Switch

Push (if fault condition is corrected) –

- resets BLEED TRIP OFF, PACK and ZONE TEMP lights
- related engine bleed air valves open, or related pack valves open, or related air mix valves open
- lights remain illuminated until reset.

Equipment Cooling Panel

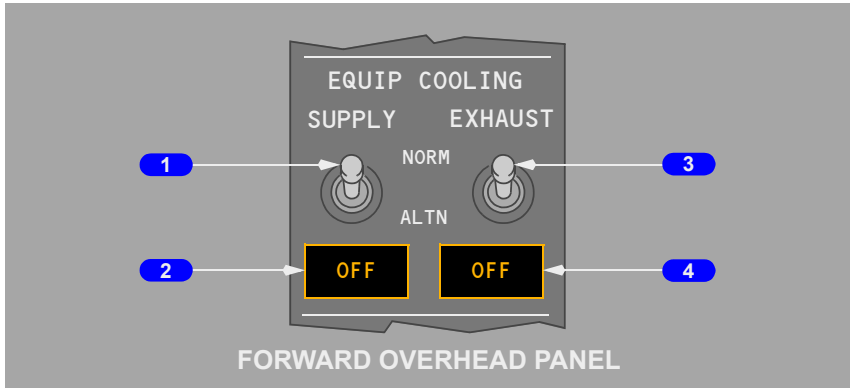

1 Equipment (EQUIP) COOLING SUPPLY Switch

NORM – normal cooling supply fan activated.

ALTN – alternate cooling supply fan activated.

2 Equipment Cooling Supply OFF Light

Illuminated (amber) – no airflow from selected cooling supply fan.

3 Equipment (EQUIP) COOLING EXHAUST Switch

NORM – normal cooling exhaust fan activated.

ALTN – alternate cooling exhaust fan activated.

4 Equipment Cooling Exhaust OFF Light

Illuminated (amber) – no airflow from selected cooling exhaust fan.

Cabin Altitude Panel

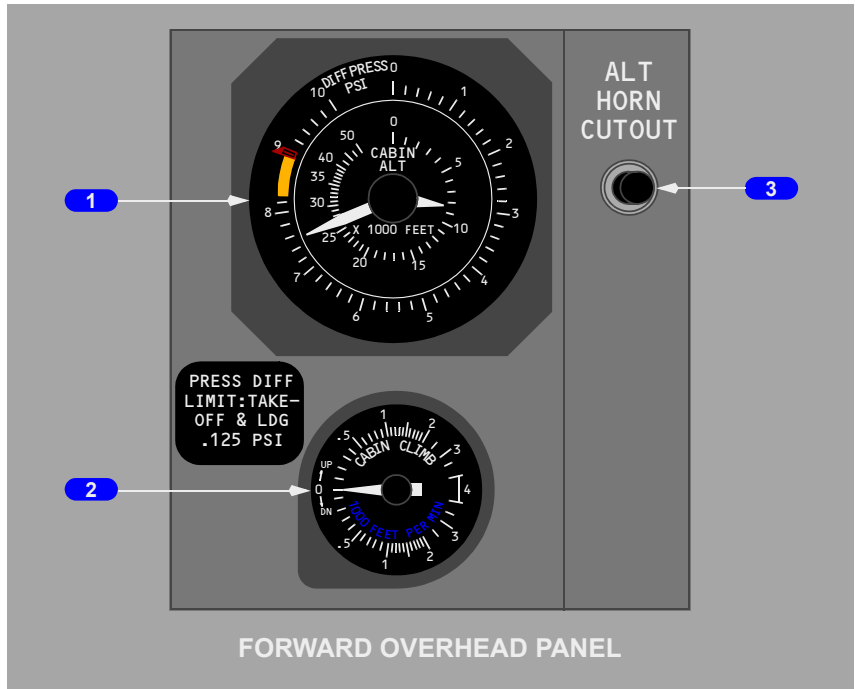

1 CABIN Altimeter (ALT)/Differential Pressure (DIFF PRESS) Indicator

Inner Scale – indicates cabin altitude in feet.

Outer Scale – indicates differential pressure between cabin and ambient in psi.

2 CABIN Rate of CLIMB Indicator

Indicates cabin rate of climb or descent in feet per minute.

3 Altitude (ALT) HORN CUTOUT Switch

Push –

- cuts out intermittent cabin altitude warning horn
- altitude warning horn sounds when cabin reaches 10,000 feet altitude.

Cabin Pressurization Panel

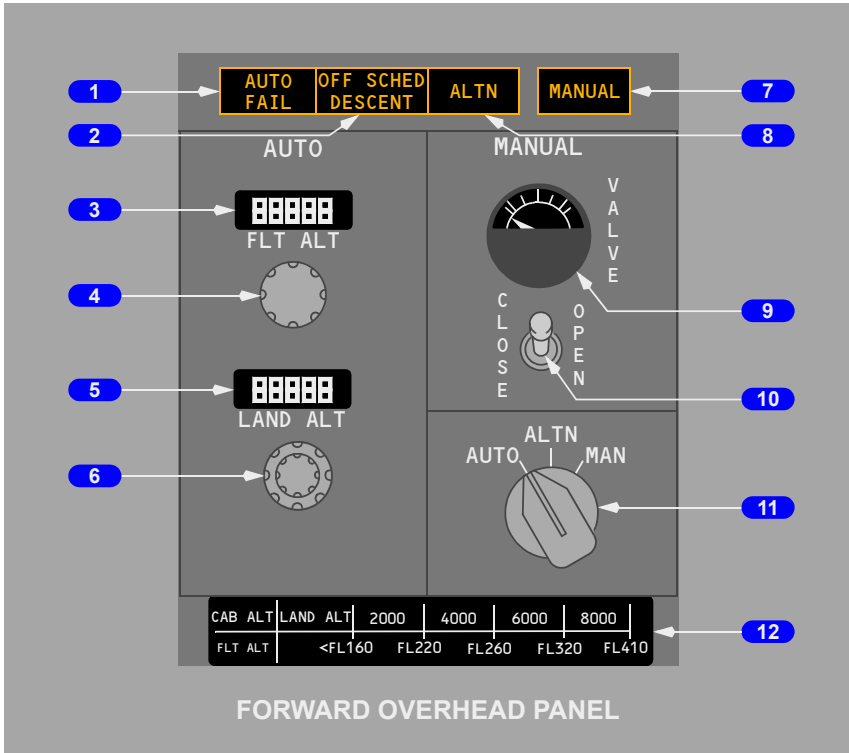

1 AUTO FAIL Light

Illuminated (amber) – automatic pressurization system failure detected:

- indicates a single controller failure when ALTN light is also illuminated
- indicates a dual controller failure when illuminated alone.

2 OFF Schedule (SCHED) DESCENT Light

Illuminated (amber) – airplane descended before reaching the planned cruise altitude set in the FLT ALT indicator.

3 Flight Altitude (FLT ALT) Indicator

- indicates selected cruise altitude
- set before takeoff.

4 Flight Altitude Selector

Rotate – set planned cruise altitude. (-1,000 ft. to 42,000 ft. in 500 ft. increments).

737 Flight Crew Operations Manual

5 Landing Altitude (LAND ALT) Indicator

- indicates altitude of intended landing field
- set before takeoff.

6 Landing Altitude Selector

Rotate – select planned landing field altitude. (-1,000 ft. to 14,000 ft. in 50 ft. increments).

7 MANUAL Light

Illuminated (green) – pressurization system operating in the manual mode.

8 Alternate (ALTN) Light

Illuminated (green) – pressurization system operating in the alternate automatic mode:

- Illumination of both ALTN and AUTO FAIL lights indicates a single controller failure and automatic transfer to ALTN mode
- pressurization mode selector in ALTN position.

9 Outflow VALVE Position Indicator

- indicates position of outflow valve
- operates in all modes.

10 Outflow Valve Switch (spring-loaded to center)

CLOSE – closes outflow valve electrically with pressurization mode selector in MAN position.

OPEN – opens outflow valve electrically with pressurization mode selector in MAN position.

11 Pressurization Mode Selector

AUTO – pressurization system controlled automatically.

ALTN – pressurization system controlled automatically using ALTN controller.

MAN –

- pressurization system controlled manually by outflow valve switch
- both auto controllers bypassed.

12 Cabin /Flight Altitude (CAB ALT)(FLT ALT) Placard

Used to determine setting for cabin altitude when operating in manual mode.



Intentionally
Blank

Introduction

Air for the bleed air system can be supplied by the engines, APU, or an external air cart/source. The APU or external cart supplies air to the bleed air duct prior to engine start. After engine start, air for the bleed air system is normally supplied by the engines.

The following systems rely on the bleed air system for operation:

- Air conditioning/pressurization
- Wing and engine thermal anti-icing
- Engine starting
- Hydraulic reservoirs pressurization
- Water tank pressurization

Switches on the air conditioning panel operate the APU and engine bleed air supply system.

Engine Bleed System Supply

Engine bleed air is obtained from the 5th and 9th stages of the compressor section. When 5th stage low pressure bleed air is insufficient for the bleed air system requirements, the high stage valve modulates open to maintain adequate bleed air pressure. During takeoff, climb, and most cruise conditions, low pressure bleed air from the 5th stage is adequate and the high stage valve remains closed.

Engine Bleed Air Valves

The engine bleed air valve acts as a pressure regulator and shutoff valve. With the engine bleed air switch ON, the valve is DC activated and pressure operated. The valve maintains proper system operating pressure and reduces bleed air outflow in response to high bleed air temperature.

Bleed Trip Sensors

Bleed trip sensors illuminate the respective BLEED TRIP OFF light when engine bleed air temperature or pressure exceeds a predetermined limit. The respective engine bleed air valve closes automatically.

Duct Pressure Transmitters

Duct pressure transmitters provide bleed air pressure indications to the respective (L and R) pointers on the bleed air duct pressure indicator. The indicator is AC operated. Differences between L and R duct pressure on the bleed air duct pressure indicator are considered normal as long as there is sufficient air for cabin pressurization.

Isolation Valve

The isolation valve isolates the left and right sides of the bleed air duct during normal operations. The isolation valve is AC operated.

With the isolation valve switch in AUTO, both engine bleed air switches ON, and both air conditioning pack switches AUTO or HIGH, the isolation valve is closed. The isolation valve opens if either engine bleed air switch or air conditioning pack switch is positioned OFF. Isolation valve position is not affected by the APU bleed air switch.

External Air Connection

An external air cart/source provides an alternate air source for engine start or air conditioning.

APU Bleed Air Valve

The APU bleed air valve permits APU bleed air to flow to the bleed air duct. The valve closes automatically when the APU is shut down. The APU bleed air valve is DC controlled and pressure operated.

With both the APU and engine bleed air valves open, and the engines operating at idle thrust, there is a possibility of APU bleed air backpressuring the 9th stage modulating and shutoff valve. This would cause the 9th stage valve to close.

DUAL BLEED Light

The DUAL BLEED light illuminates whenever the APU bleed air valve is open and the position of the engine bleed air switches and isolation valve would permit possible backpressure of the APU. Therefore, thrust must be limited to idle with the DUAL BLEED light illuminated.

Bleed Air System Schematic

YA371 - YA377, YE321 - YE326

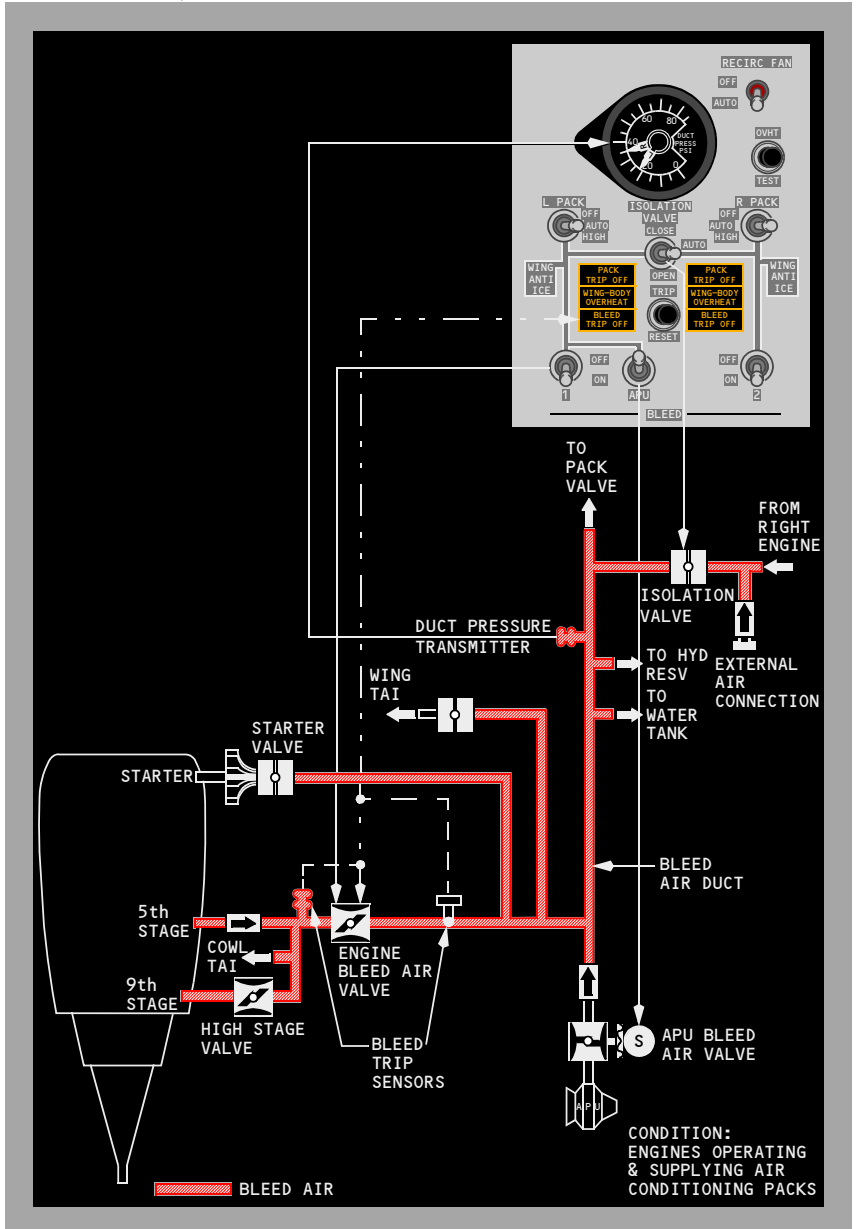

YC201 - YC207

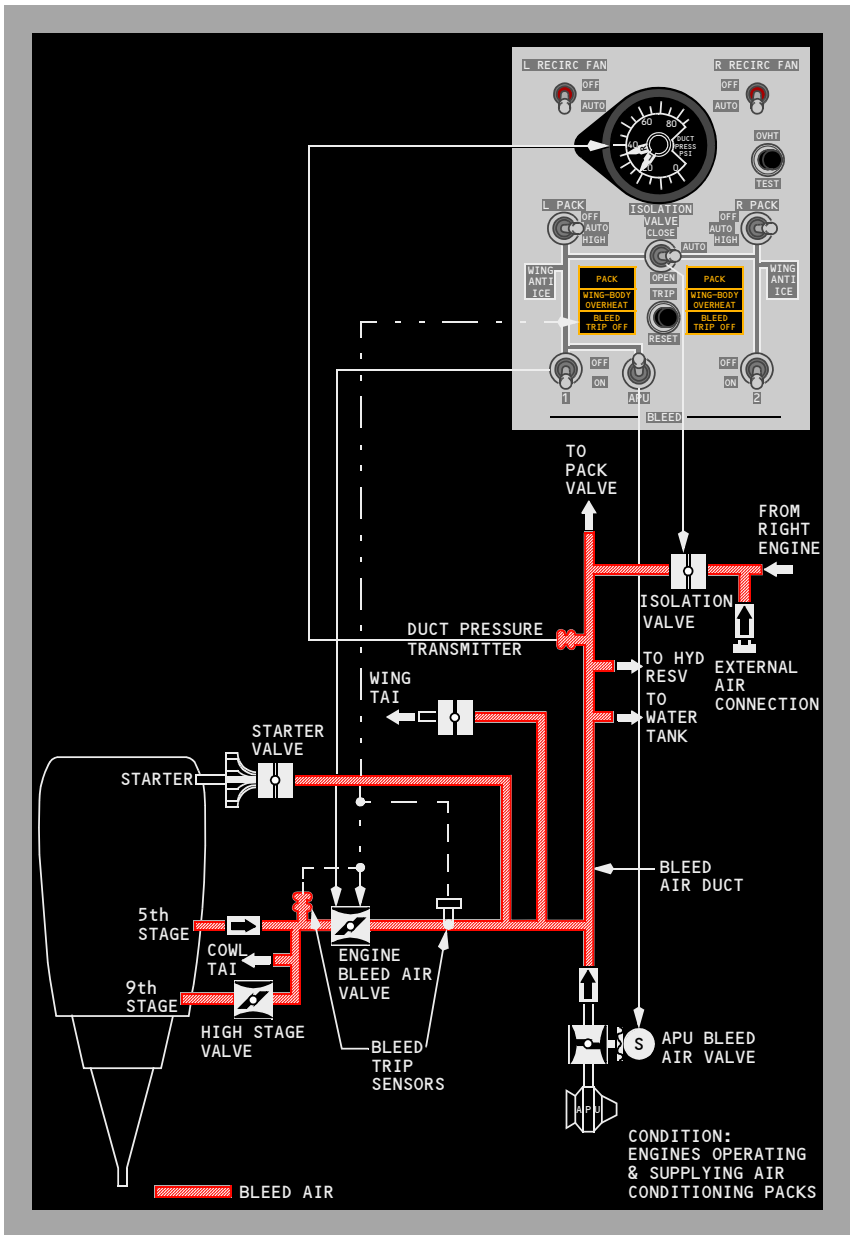

Wing-Body Overheat

A wing-body overheat condition is caused by a bleed air duct leak. It is sensed by the overheat sensors located as shown.

Wing-Body Overheat Ducts and Lights

YA371 - YA377, YE321 - YE326

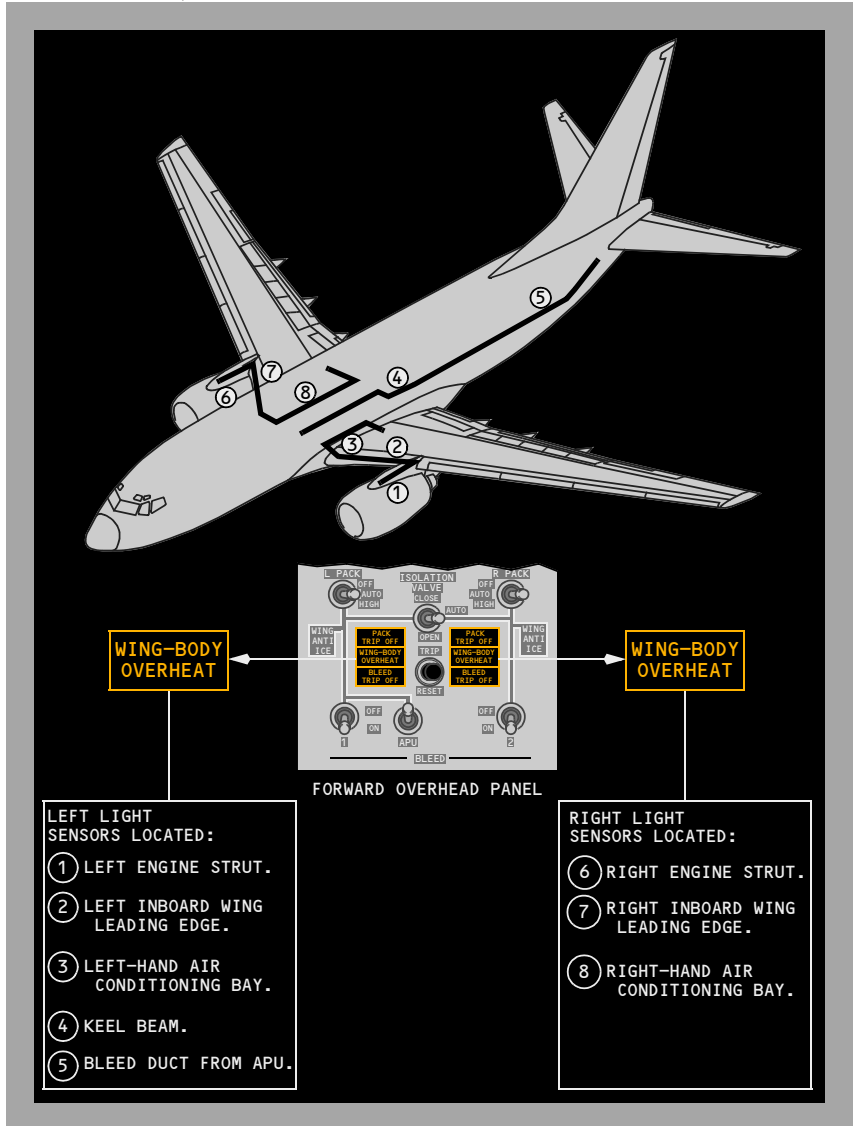

YC201 - YC207

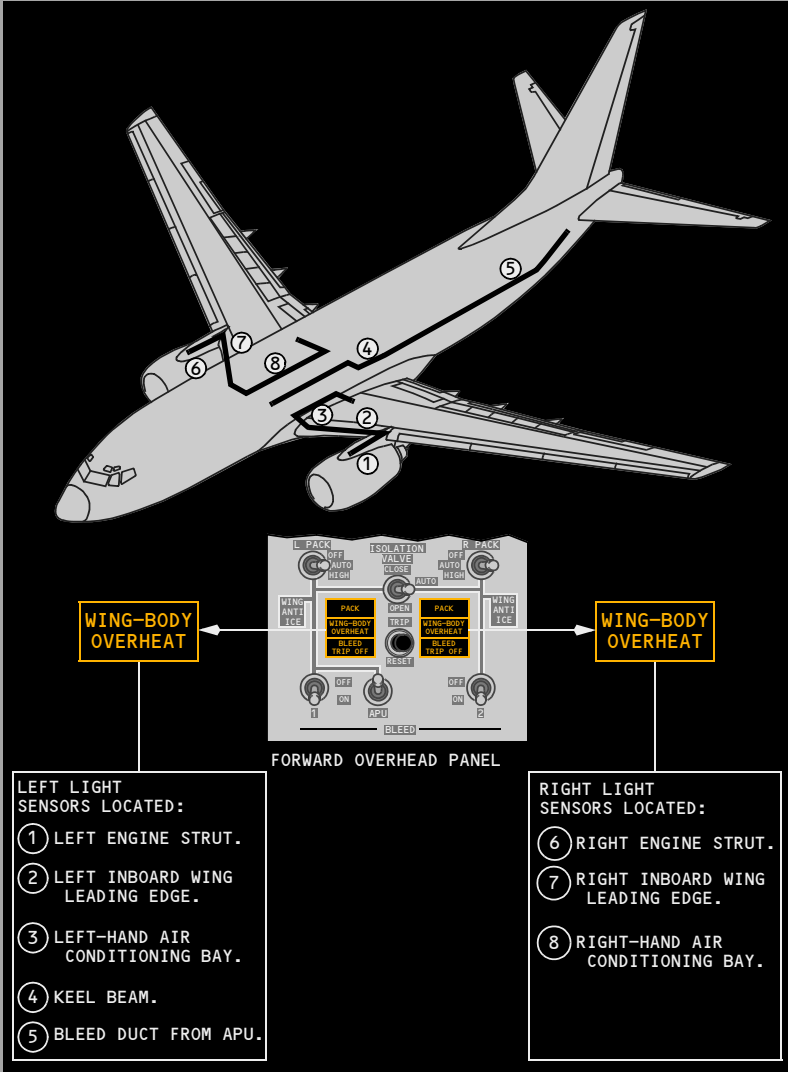



This Section Applies to YA371 - YA377, YE321 - YE326

Introduction

Conditioned air for the cabin comes from either the airplane air conditioning system or a preconditioned ground source. Air from the preconditioned ground source enters the air conditioning system through the mix manifold.

The air conditioning system provides temperature controlled air by processing bleed air from the engines, APU, or a ground air source in air conditioning packs. Conditioned air from the left pack, upstream of the mix manifold, flows directly to the flight deck. Excess air from the left pack, air from the right pack, and air from the recirculation system is combined in the mix manifold. The mixed air is then distributed through the left and right sidewall risers to the passenger cabin.

Air Conditioning Pack

The flow of bleed air from the main bleed air duct through each air conditioning pack is controlled by the respective pack valve. Normally the left pack uses bleed air from engine No. 1 and the right pack uses bleed air from engine No. 2. A single pack is capable of maintaining pressurization and acceptable temperatures throughout the airplane up to the maximum certified ceiling.

The APU is capable of supplying bleed air for two packs on the ground, or one pack in flight. Most external air carts are capable of supplying adequate bleed air for two pack operation. Do not operate more than one pack from one engine at any time.

Airflow Control

With both air conditioning pack switches in AUTO and both packs operating, the packs provide “normal air flow”. However, with one pack not operating, the other pack automatically switches to “high air flow” in order to maintain the necessary ventilation rate. This automatic switching is inhibited when the airplane is on the ground, or in flight with the flaps extended, to insure adequate engine power for single engine operation. Automatic switching to “high air flow” occurs if both engine bleed air switches are OFF and the APU bleed air switch is ON, regardless of flap position, air/ground status or number of packs operating.

With the air conditioning pack switch in HIGH, the pack provides “high air flow”. Additionally, an “APU high air flow” rate is available when the airplane is on the ground, the APU bleed air switch is ON and either or both pack switches are positioned to HIGH. This mode is designed to provide the maximum airflow when the APU is the only source of bleed air.

Ram Air System

The ram air system provides cooling air for the heat exchangers. Operation of the system is automatically controlled by the packs through operation of ram air inlet doors.

On the ground, or during slow flight with the flaps not fully retracted, the ram air inlet doors move to the full open position for maximum cooling. In normal cruise, the doors modulate between open and closed. A RAM DOOR FULL OPEN light illuminates whenever a ram door is fully open.

Deflector doors are installed forward of the ram air inlet doors to prevent slush ingestion prior to liftoff and after touchdown. Deflector doors extend when activated electrically by the air-ground safety sensor.

Cooling Cycle

The flow through the cooling cycle starts with bleed air passing through a heat exchanger for cooling. The air then flows to an air cycle machine for refrigeration and to a water separator which removes moisture. The processed cold air is then combined with hot air. The conditioned air flows into the mix manifold and distribution system.

Overheat protection is provided by temperature sensors located in the cooling cycle. An overheat condition causes the pack valve to close and the PACK TRIP OFF light to illuminate.

Air Mix Valves

The two air mix valves for each pack control hot and cold air according to the setting of the CONT CABIN or PASS CABIN temperature selector. Air that flows through the cold air mix valve is processed through a cooling cycle and then combined with hot air flowing from the hot air mix valve.

In the automatic temperature mode, the air mix valves are operated by the automatic temperature controller. The automatic temperature controller uses inputs from the respective temperature selector and cabin temperature sensor. The automatic temperature controller is bypassed when the temperature selector is positioned to MANUAL.

Anytime the pack valve closes, the air mix valves are driven to the full cold position automatically. This aids startup of the cooling cycle and prevents nuisance hot air trips when the pack is turned on.

Air Conditioning Pack Schematic

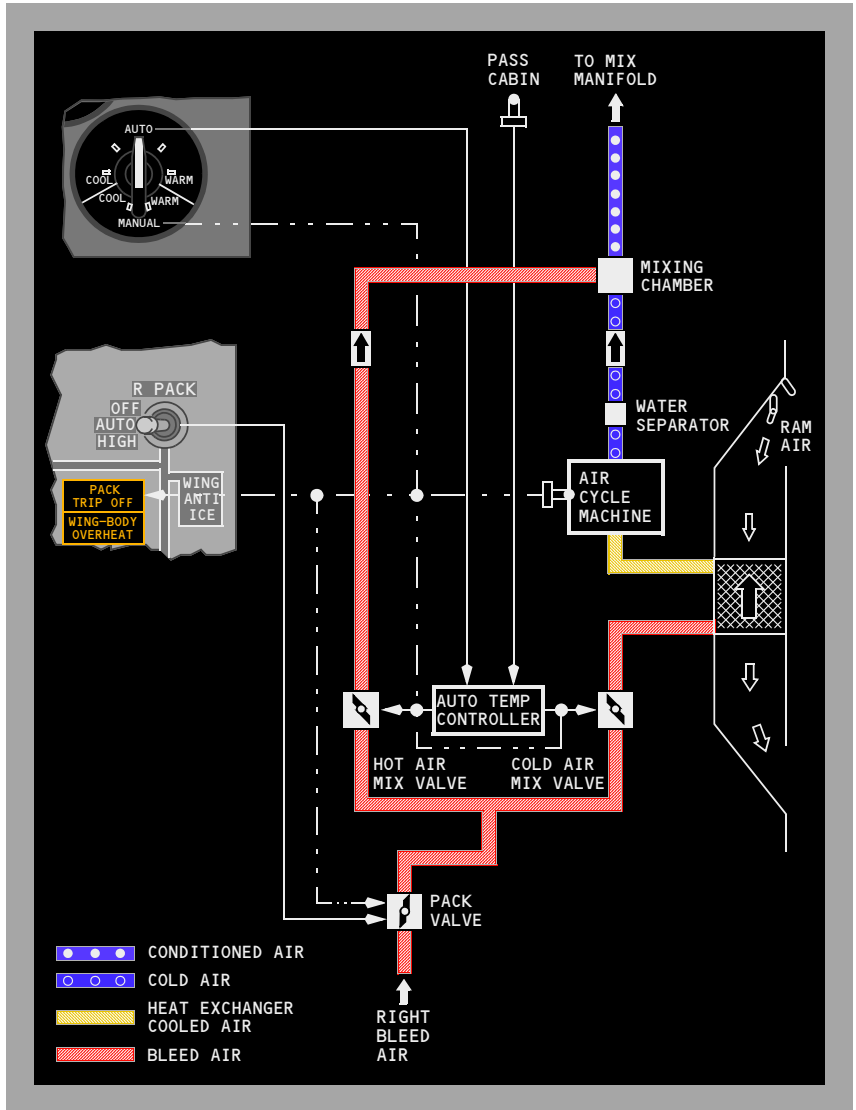

Air Conditioning Distribution

Conditioned air is collected in the mix manifold. The temperature of the air is directly related to the setting of the CONT CABIN and PASS CABIN temperature selectors.

Overheat detection is provided by temperature sensors located downstream of the packs. An overheat condition causes the appropriate mix valves to drive full cold and the DUCT OVERHEAT light to illuminate. A temperature higher than the duct overheat causes the appropriate pack valve to close and the PACK TRIP OFF light to illuminate.

Flight Deck

Since the flight deck requires only a fraction of the air supply provided by the left pack, most of the left pack air output is mixed with the right pack supply and routed to the passenger cabin.

Conditioned air for the flight deck branches into several risers which end at the floor, ceiling, and foot level outlets. Air diffusers on the floor under each seat deliver continuous air flow as long as the manifold is pressurized.

Overhead diffusers are located on the flight deck ceiling, above and aft of the No. 3 windows. Each of these outlets can be opened or closed as desired by turning a slotted adjusting screw.

There is also a dual purpose valve behind the rudder pedals of each pilot. These valves provide air for warming the pilots' feet and for defogging the inside of the No. 1 windshields. Each valve is controlled by knobs located on the Captain's and First Officer's panel, respectively.

Passenger Cabin

The passenger cabin air supply distribution system consists of the mix manifold, sidewall risers, and an overhead distribution duct.

Sidewall risers go up the right and left wall of the passenger cabin to supply air to the overhead distribution duct. The overhead distribution duct routes conditioned air to the passenger cabin. It extends from the forward to the aft end of the ceiling along the airplane centerline and also supplies the sidewall diffusers.

Recirculation Fan

The recirculation fan system reduces the air conditioning system pack load and the engine bleed air demand. Air from the passenger cabin and electrical equipment bay is drawn to the forward cargo bay where it is filtered and recirculated to the mix manifold. The fan is driven by an AC motor. The fan operates with the recirc fan switch in AUTO except with both packs on and one or both in HIGH.

Equipment Cooling

The equipment cooling system cools electronic equipment in the flight deck and the E & E bay.

737 Flight Crew Operations Manual

The equipment cooling system consists of a supply duct and an exhaust duct. Each duct has a normal fan and an alternate fan. The supply duct supplies cool air to the flight deck displays and electronic equipment in the E & E bay. The exhaust duct collects and discards warm air from the flight deck displays, the overhead and aft electronic panels, circuit breaker panels in the flight deck, and electronic equipment in the E & E bay.

Loss of airflow due to failure of an equipment cooling fan results in illumination of the related equipment cooling OFF light. Selecting the alternate fan should restore airflow and extinguish the OFF light within approximately 5 seconds.

If an overtemperature occurs on the ground, alerting is provided through the crew call horn in the nose wheel well.

Forward Cargo Compartment

The recirculation fan system circulates air from the passenger cabin around the lining of the forward cargo compartment. When the overboard exhaust valve is closed, exhaust air from the equipment cooling system is also diffused to the lining of the forward cargo compartment for additional inflight heating.

Conditioned Air Source Connection

A ground air conditioning source may be connected to the mix manifold to distribute preconditioned air throughout the airplane.

Air Conditioning Distribution Schematic

YE321 - YE326

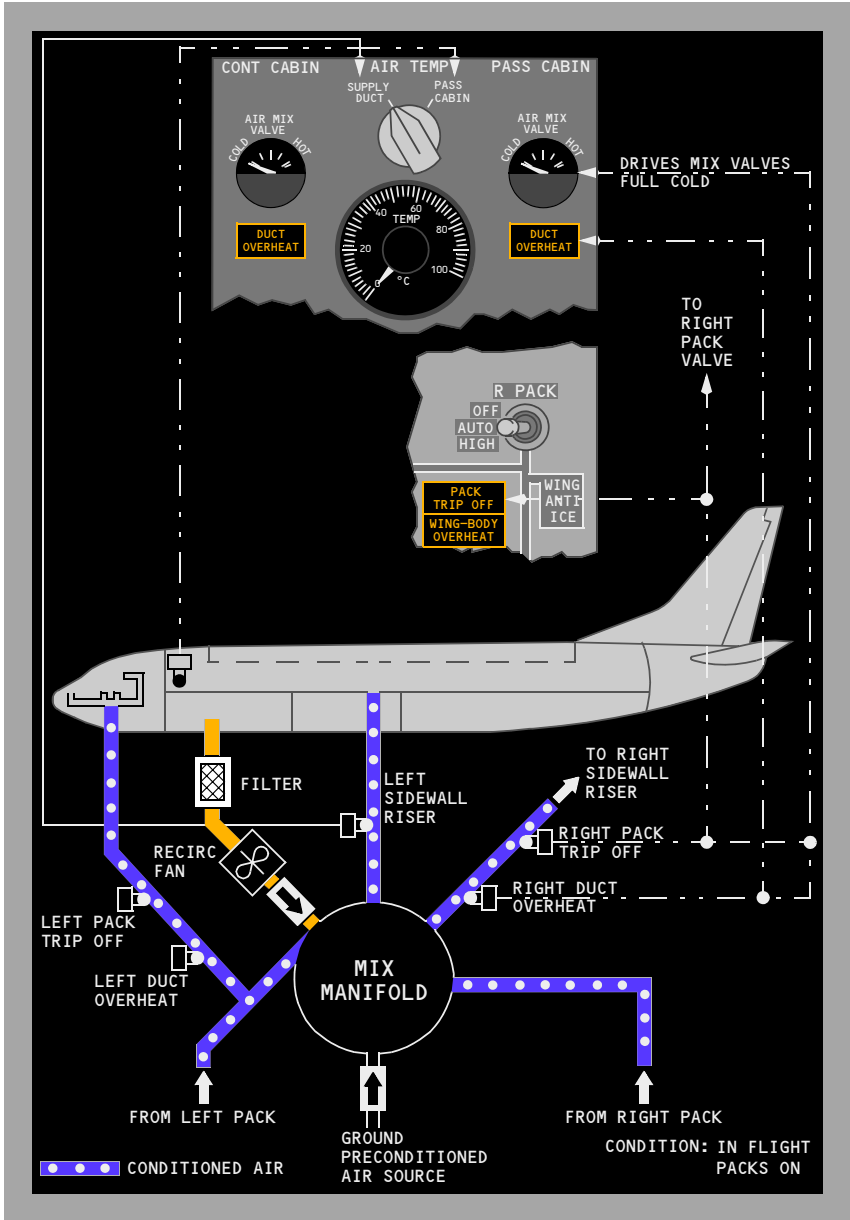

737 Flight Crew Operations Manual

YA371 - YA377

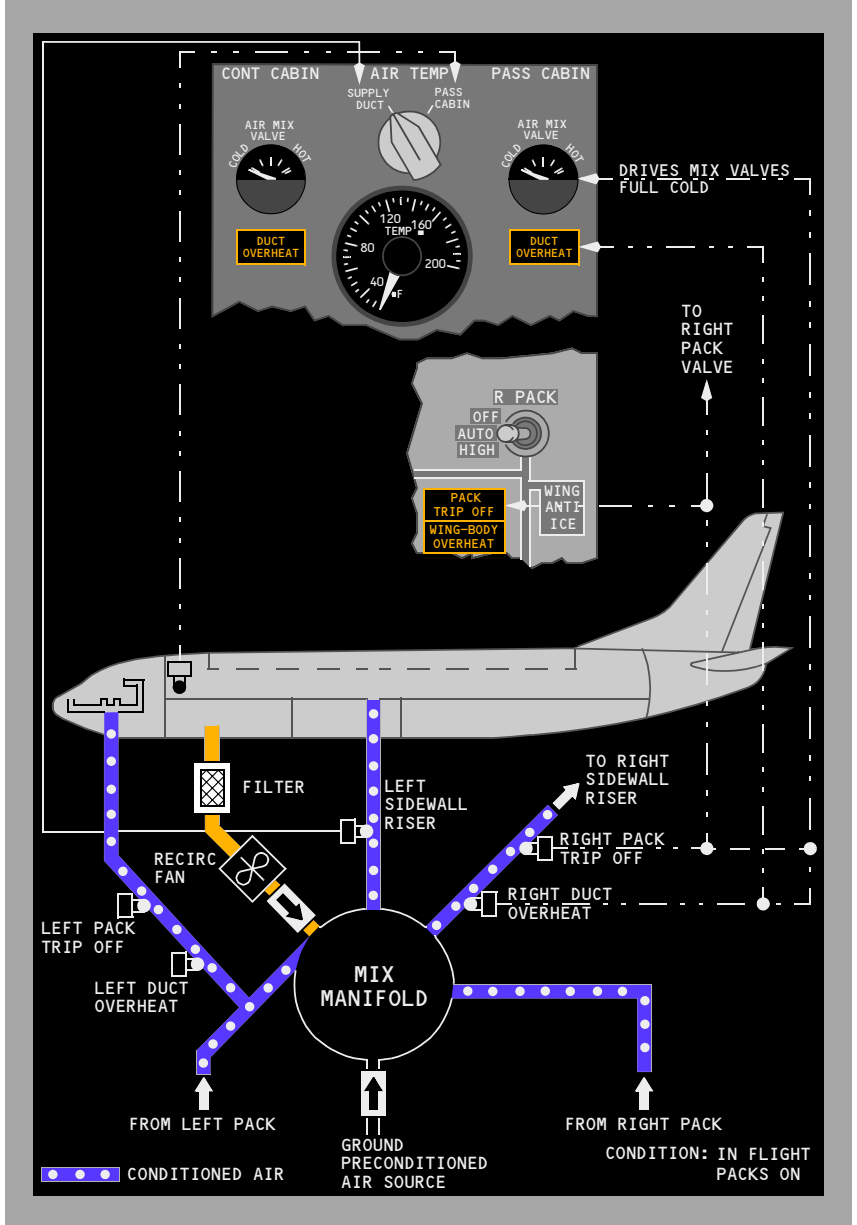

Intentionally
Blank



This Section Applies to YC201 - YC207

Introduction

Conditioned air for the cabin comes from either the airplane air conditioning system or a preconditioned ground source. Air from the preconditioned ground source enters the air conditioning system through the mix manifold.

The air conditioning system provides temperature controlled air by processing bleed air from the engines, APU, or a ground air source in air conditioning packs. Conditioned air from the left pack, upstream of the mix manifold, flows directly to the flight deck. Excess air from the left pack, air from the right pack, and air from the recirculation system is combined in the mix manifold. The mixed air is then distributed through the left and right sidewall risers to the passenger cabin.

Air Conditioning Pack

The flow of bleed air from the main bleed air duct through each air conditioning pack is controlled by the respective pack valve. Normally, the left pack uses bleed air from engine No. 1 and the right pack uses bleed air from engine No. 2. A single pack is capable of maintaining pressurization and acceptable temperatures throughout the airplane up to the maximum certified ceiling.

The APU is capable of supplying bleed air for two packs on the ground, or one pack in flight. Most external air carts are capable of supplying adequate bleed air for two pack operation. Do not operate more than one pack from one engine at any time.

Airflow Control

With both air conditioning pack switches in AUTO and both packs operating, the packs provide “normal air flow”. However, with one pack not operating, the other pack automatically switches to “high air flow” in order to maintain the necessary ventilation rate. This automatic switching is inhibited when the airplane is on the ground, or in flight with the flaps extended, to insure adequate engine power for single engine operation. Automatic switching to “high air flow” occurs if both engine bleed air switches are OFF and the APU bleed air switch is ON, regardless of flap position, air/ground status or number of packs operating.

With the air conditioning pack switch in HIGH, the pack provides “high air flow”. Additionally, an “APU high air flow” rate is available when the airplane is on the ground, the APU bleed air switch is ON and either or both pack switches are positioned to HIGH. This mode is designed to provide the maximum airflow when the APU is the only source of bleed air.

Ram Air System

The ram air system provides cooling air for the heat exchangers. Operation of the system is automatically controlled by the packs through operation of ram air inlet doors.

On the ground, or during slow flight with the flaps not fully retracted, the ram air inlet doors move to the full open position for maximum cooling. In normal cruise, the doors modulate between open and closed. A RAM DOOR FULL OPEN light illuminates whenever a ram door is fully open.

Deflector doors are installed forward of the ram air inlet doors to prevent slush ingestion prior to liftoff and after touchdown. Deflector doors extend when activated electrically by the air-ground safety sensor.

Cooling Cycle

Flow through the cooling cycle starts with bleed air passing through a heat exchanger for cooling. The air then flows to an air cycle machine for refrigeration. The processed cold air is then combined with hot air which has bypassed the air cycle machine, then through a high pressure water separator which removes moisture. This conditioned air then flows into the mix manifold and distribution system.

Overheat protection is provided by temperature sensors located in the cooling cycle. An overheat condition causes the pack valve to close and the PACK light to illuminate.

Pack Temperature Control

Electronic controllers command the pack temperature control valve toward open or closed to satisfy pack discharge requirements.

If a primary pack control fails, the affected pack is controlled by the standby pack control in the opposite controller. A primary or standby pack control failure causes the PACK, MASTER CAUTION and AIR COND System Annunciator lights to illuminate during recall.

If both the primary and the standby pack controls fail for the same pack, the PACK, MASTER CAUTION, and AIR COND System Annunciator lights illuminate. The pack will continue to operate without control unless excessive temperatures cause the pack to trip off.

Air Conditioning Pack Schematic

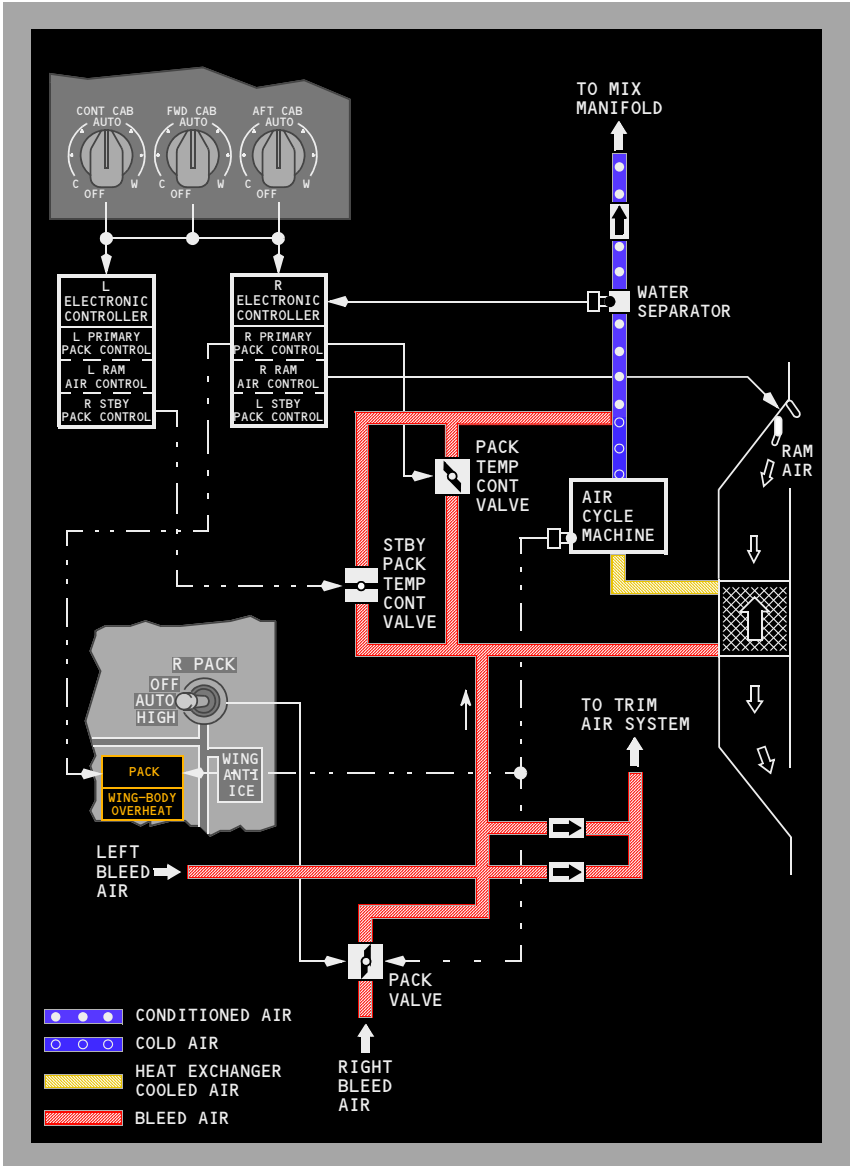

Zone Temperature Control

There are three zones: flight deck, forward cabin and aft cabin. Desired zone temperature is set by adjusting the individual Temperature Selectors. The selector range is approximately 65°F (18°C) to 85°F (30°C).

The packs produce an air temperature that satisfies the zone which requires the most cooling. Zone temperature is controlled by introducing the proper amount of trim air to the zone supply ducts. The quantity of trim air is regulated by individual trim air modulating valves.

During single pack operation with the TRIM AIR selected ON, zone temperature is controlled the same as during two pack operation. During single pack operation with the TRIM AIR selected OFF, the pack attempts to produce an air temperature to satisfy the average temperature demands of all three zones.

If air in a zone supply duct overheats, the associated amber ZONE TEMP light illuminates, and the associated trim air modulating valve closes. The trim air modulating valve may be reopened after the duct has cooled by pushing the TRIP RESET Switch.

Zone Temperature Control Modes

The left electronic controller controls the aft cabin zone and provides backup control for the flight deck. The right controller controls the forward cabin zone and provides primary control for the flight deck.

Failure of the primary flight deck temperature control will cause an automatic switch to the back up control and will illuminate the CONT CAB amber ZONE TEMP light upon Master Caution Recall. Failure of both the primary and standby controls will illuminate the lights automatically.

Failure of the forward or aft cabin temperature control will cause the associated trim air modulating valve to close. The Temperature Selectors operate normally, but the Temperature Selector settings of the two passenger cabin zones will be averaged. The amber ZONE TEMP light will illuminate upon Master Caution Recall to indicate failure of the associated zone control.

Unbalanced Pack Temperature Control Mode

Any failure affecting the supply of trim air will cause the temperature control system to control both packs independently. If flight deck trim air is lost, the left pack will provide conditioned air to the flight deck at the selected temperature and the right pack will satisfy the demand of the passenger zone which requires the most cooling. If a passenger cabin zone trim air, or all trim air is lost, the forward and aft zone temperature demands will be averaged for control of the right pack.

If any individual zone is switched OFF, the Temperature Selector setting will be ignored by the temperature control system.

Standby Pack Average Temperature

If all zone controls and primary pack controls fail, the standby pack controls command the packs to produce air temperatures which will satisfy the average temperature demand of the two cabin zones. The trim air modulating valves will close. The flight deck zone Temperature Selector will have no effect on the standby pack controls.

Fixed Cabin Temperature

If all Temperature Selectors are positioned OFF, the pack controls will cause the left pack to maintain a fixed temperature of 75°F (24°C) and the right pack to maintain 65°F (18°C) as measured at the pack temperature sensor.

Air Conditioning Distribution

Conditioned air is collected in the mix manifold. The temperature of the air is directly related to the setting of the Temperature Selectors.

Overheat detection is provided by temperature sensors located downstream of the packs and the mix manifold. An overheat condition causes the appropriate trim air modulating valve to close and the ZONE TEMP light to illuminate.

Flight Deck

Since the flight deck requires only a fraction of the air supply provided by the left pack, most of the left pack output is routed to the mix manifold.

Conditioned air for the flight deck branches into several risers which end at the floor, ceiling and foot level outlets. Air diffusers on the floor under each seat deliver continuous air flow as long as the manifold is pressurized.

Overhead diffusers are located on the flight deck ceiling, above and aft of the No. 3 windows. Each of these outlets can be opened or closed as desired by turning a slotted adjusting screw.

There is also a dual purpose valve behind the rudder pedal of each pilot. These valves provide air for warming the pilots' feet and for defogging the inside of the No. 1 windshields. Each valve is controlled by knobs located on the Captain's and First Officer's panels.

Passenger Cabin

The passenger cabin air supply distribution system consists of the mix manifold, sidewall risers, and an overhead distribution duct.

Sidewall risers go up the right and left walls of the passenger cabin to supply air to the overhead distribution duct. The overhead distribution duct routes conditioned air to the passenger cabin. It extends from the forward to the aft end of the ceiling along the airplane centerline and also supplies the sidewall diffusers.

Recirculation Fan

The recirculation fan system reduces the air conditioning system pack load and the engine bleed air demand. Air from the passenger cabin and electrical equipment bay is drawn to the forward cargo bay where it is filtered and recirculated to the mix manifold. The fans are driven by AC motors. Each recirculation fan operates only if the respective RECIRC FAN Switch is selected to AUTO. In flight, the left recirculation fan operates if both packs are operating unless either PACK switch is in HIGH. The right recirculation fan operates in flight if both packs are operating unless both PACK switches are in HIGH. On the ground, the left recirculation fan operates unless both PACK switches are in HIGH and the right recirculation fan operates even if both PACK switches are in HIGH.

Equipment Cooling

The equipment cooling system cools electronic equipment in the flight deck and the E & E bay.

The equipment cooling system consists of a supply duct and an exhaust duct. Each duct has a normal fan and an alternate fan. The supply duct supplies cool air to the flight deck displays and electronic equipment in the E & E bay. The exhaust duct collects and discards warm air from the flight deck displays, the overhead and aft electronic panels, circuit breaker panels in the flight deck, and electronic equipment in the E & E bay.

Loss of airflow due to failure of an equipment cooling fan results in illumination of the related equipment cooling OFF light. Selecting the alternate fan should restore airflow and extinguish the OFF light within approximately 5 seconds.

If an overtemperature occurs on the ground, alerting is provided through the crew call horn in the nose wheel well.

Forward Cargo Compartment

The recirculation fan system circulates air from the passenger cabin around the lining of the forward cargo compartment. When the overboard exhaust valve is closed, exhaust air from the equipment cooling system is also diffused to the lining of the forward cargo compartment for additional inflight heating.

Conditioned Air Source Connection

A ground air conditioning source may be connected to the mix manifold to distribute preconditioned air throughout the airplane.

Air Conditioning Distribution Schematic

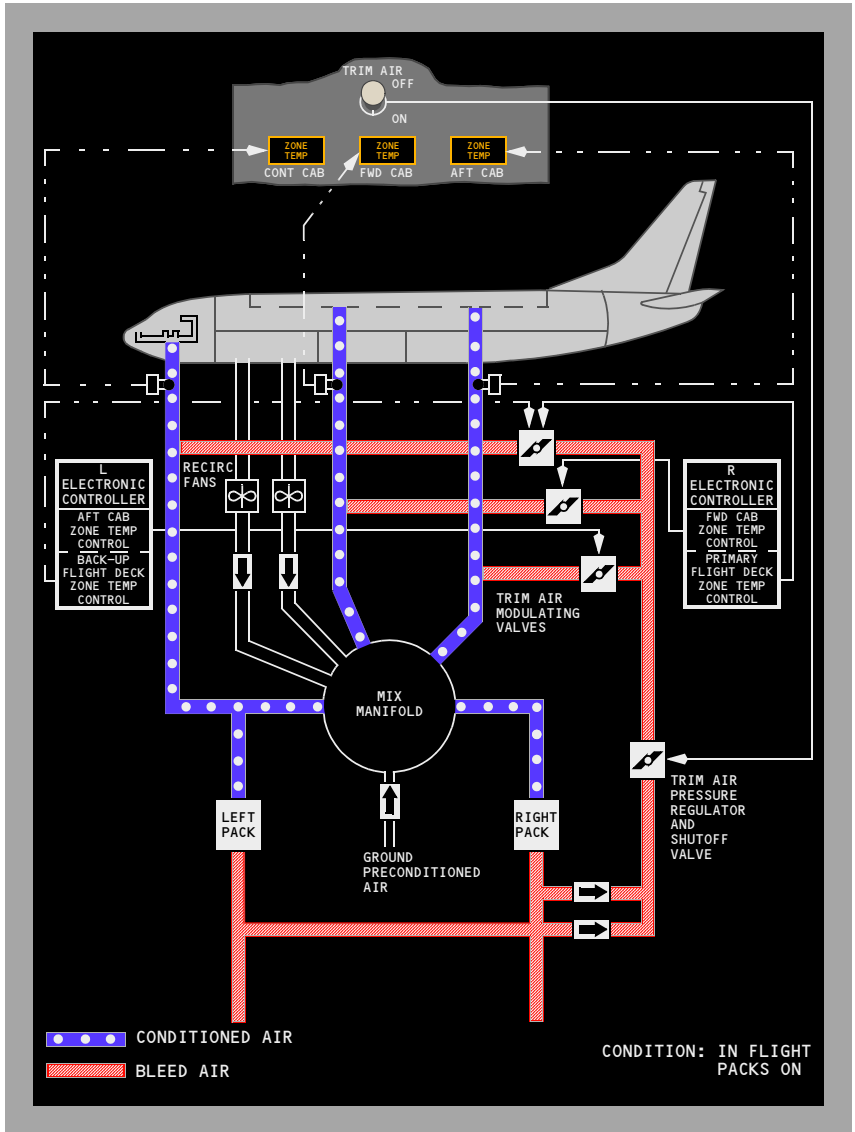



Intentionally
Blank

Introduction

Cabin pressurization is controlled during all phases of airplane operation by the cabin pressure control system. The cabin pressure control system includes two identical automatic controllers available by selecting AUTO or ALTN and a manual (MAN) pilot-controlled mode.

The system uses bleed air supplied to and distributed by the air conditioning system. Pressurization and ventilation is controlled by modulating the outflow valve and the overboard exhaust valve.

Pressure Relief Valves

Two pressure relief valves provide safety pressure relief by limiting the differential pressure to a maximum of 9.1 psi. A negative relief valve prevents external atmospheric pressure from exceeding internal cabin pressure.

Cabin Pressure Controller

Cabin altitude is normally rate-controlled by the cabin pressure controller up to a cabin altitude of 8,000 feet at the airplane maximum certified ceiling of 41,000 feet.

The cabin pressure controller controls cabin pressure in the following modes:

- AUTO – Automatic pressurization control; the normal mode of operation. Uses DC motor.
- ALTN – Automatic pressurization control; the alternate mode of operation. Uses DC motor.
- MAN – Manual control of the system using DC motor.

The air data inertial reference units (ADIRUs) provides ambient static pressure, baro corrected altitude, non corrected altitude and calibrated airspeed to both automatic controllers. The ADIRUs receive barometric corrections from the Captain's and First Officer's BARO reference selectors.

The automatic controllers also receive throttle position from both stall management computers and signals from the air/ground sensors.

Cabin Pressure Control System Schematic

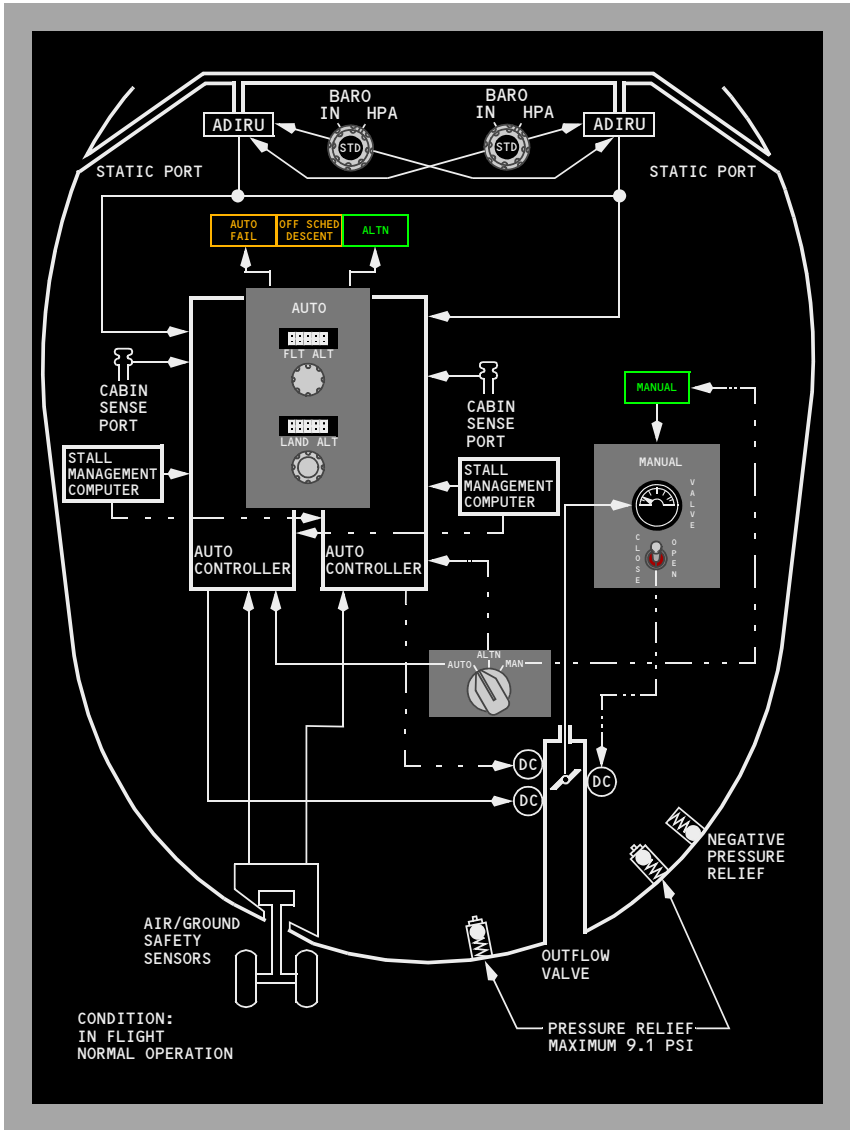

Pressurization Outflow

Cabin air outflow is controlled by the outflow valve and the overboard exhaust valve. A small amount is also exhausted through toilet and galley vents, miscellaneous fixed vents, and by seal leakage.

Outflow Valve

The outflow valve is the overboard exhaust exit for the majority of the air circulated through the passenger cabin. Passenger cabin air is drawn through foot level grills, down around the aft cargo compartment, where it provides heating, and is discharged overboard through the outflow valve.

Overboard Exhaust Valve

On the ground and in flight with low differential pressure, the overboard exhaust valve is open and warm air from the E & E bay is discharged overboard. In flight, at higher cabin differential pressures, the overboard exhaust valve is normally closed and exhaust air is diffused to the lining of the forward cargo compartment.

YA371 - YA377, YE321 - YE326

However, the overboard exhaust valve is driven open if either pack switch is in high and the recirculation fan is off. This allows for increased ventilation in the smoke removal configuration.

YC201 - YC207

However, the overboard exhaust valve is driven open if either pack switch is in high and the right recirculation fan is off. This allows for increased ventilation in the smoke removal configuration.

Pressurization Outflow Schematic

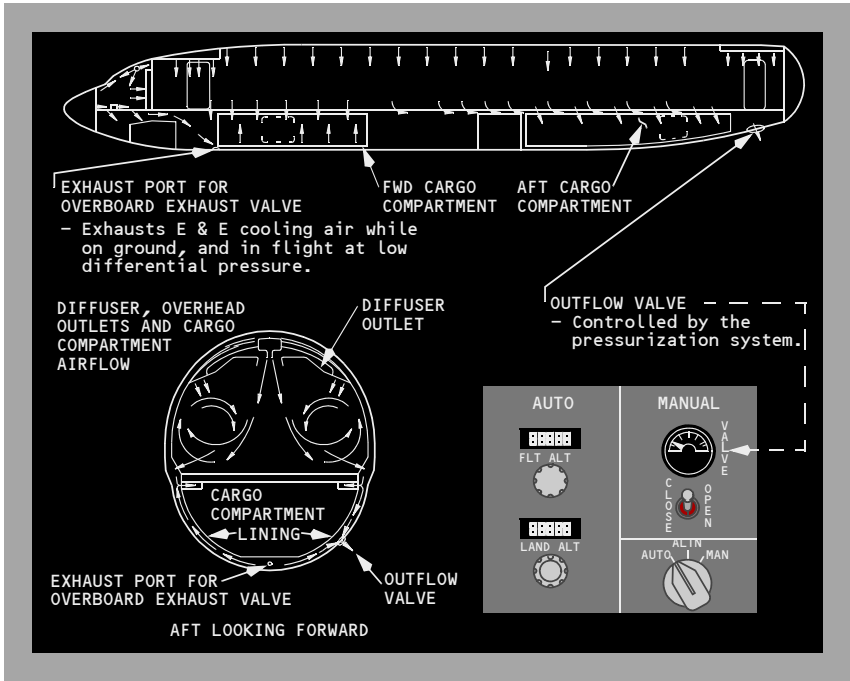

Auto Mode Operation

The AUTO system consists of two identical controllers, with one controller alternately sequenced as the primary operational controller for each new flight. The other automatic controller is immediately available as a backup.

In the AUTO or ALTN mode, the pressurization control panel is used to preset two altitudes into the auto controllers:

- FLT ALT (flight or cruise altitude).
- LAND ALT (landing or destination airport altitude).

Takeoff airport altitude (actually cabin altitude) is fed into the auto controllers at all times when on the ground.

The air/ground safety sensor signals whether the airplane is on the ground or in the air. On the ground and at lower power settings, the cabin is depressurized by driving the outflow valve to the full open position.

The cabin begins to pressurize on the ground at higher power settings. The controller modulates the outflow valve toward close, slightly pressurizing the cabin. This ground pressurization of the cabin makes the transition to pressurized flight more gradual for the passengers and crew, and also gives the system better response to ground effect pressure changes during takeoff.

In the air, the auto controller maintains a proportional pressure differential between airplane and cabin altitude. By increasing the altitude at a rate proportional to the airplane climb rate, cabin altitude change is held to the minimum rate required.

An amber OFF SCHED DESCENT light illuminates if the airplane begins to descend without having reached the preset cruise altitude; for example, a flight aborted in climb and returning to the takeoff airport. The controller programs the cabin to land at the takeoff field elevation without further pilot inputs. If the FLT ALT indicator is changed, the automatic abort capability to the original takeoff field elevation is lost.

The cruise mode is activated when the airplane climbs to within 0.25 psi of the selected FLT ALT. During cruise the controller maintains the cabin altitude slightly below the selected LAND ALT, if the differential pressure between the selected LAND ALT and FLT ALT is less than or equal to 8.35 psid above 37,000 feet, 7.80 psid with the FLT ALT between 28,000 and 37,000 feet, and 7.45 psid with FLT ALT less than 28,000 feet. If the differential pressure between the selected LAND ALT and FLT ALT is greater than these values, the controller maintains a pressure differential of 8.35 psid above 37,000 feet, 7.80 psid with the FLT ALT between 28,000 and 37,000 feet, and 7.45 psid with FLT ALT less than 28,000 feet. Deviations from flight altitude can cause the pressure differential to vary as the controller modulates the outflow valve to maintain a constant cabin altitude.

The descent mode is activated when the airplane descends 0.25 psi below the selected FLT ALT. The cabin begins a proportional descent to slightly below the selected LAND ALT. The controller programs the cabin to land slightly pressurized so that rapid changes in altitude during approach result in minimum cabin pressure changes.

While taxiing in, the controller drives the outflow valve slowly to the full open position depressurizing the cabin.

An amber AUTO FAIL light illuminates if any of the following conditions occurs:

- Loss of DC power
- Controller fault
- Outflow valve control fault
- Excessive differential pressure (> 8.75 psi)*
- Excessive rate of cabin pressure change (± 2000 sea level feet/minute)*
- High cabin altitude (above 15,800 feet).*

*If controller is not responding properly

With illumination of the AUTO FAIL light, the pressure control automatically transfers to the other auto controller (ALTN mode).

Moving the pressurization mode selector to the ALTN position extinguishes the AUTO FAIL light, however the ALTN light remains illuminated to indicate single channel operation.

737 Flight Crew Operations Manual

Flight Path Events – Auto Mode

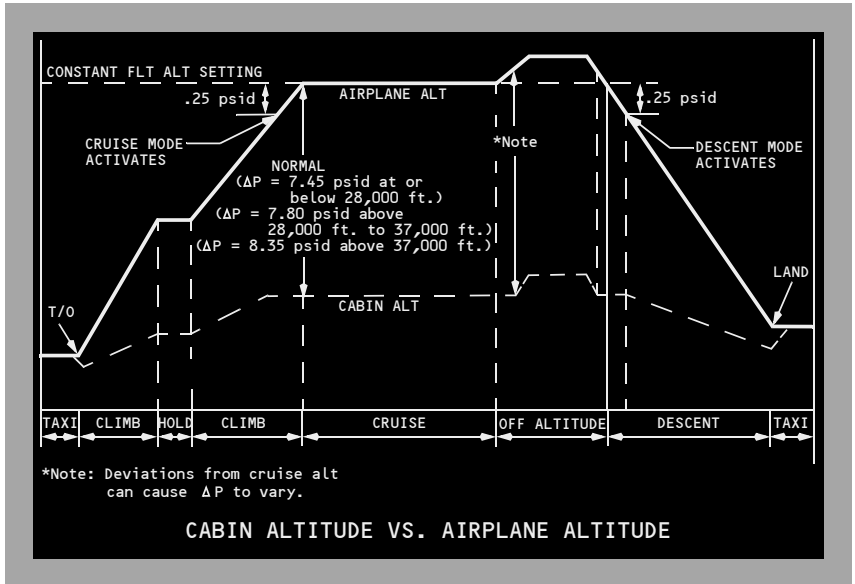

Manual Mode Operation

A green MANUAL Light illuminates with the pressurization mode selector in the MAN position.

Manual control of the cabin altitude is used if both the AUTO and ALTN modes are inoperative. In the MAN mode, the outflow valve position switch is used to modulate the outflow valve by monitoring the cabin altitude panel and valve position on the outflow valve position indicator. A separate DC motor, powered by the DC standby system, drives the outflow valve at a slower rate than the automatic modes. Outflow valve full range of motion takes up to 20 seconds.



Controls and Indicators	3.10.1
Window Heat Panel	3.10.1
Windshield/Foot Air Controls	3.10.2
Windshield Wiper Selector Panel	3.10.2
Probe Heat Panel	3.10.3
Engine Anti-Ice Panel	3.10.3
Thermal Anti-Ice Indication	3.10.4
Wing Anti-Ice Panel	3.10.5
System Description	3.20.1
Introduction	3.20.1
Anti-Ice Components Diagram	3.20.1
Flight Deck Window Heat	3.20.2
Flight Deck Window Heat Operation	3.20.2
Flight Deck Window Heat Schematic	3.20.3
Windshield Wipers	3.20.4
Probe and Sensor Heat	3.20.5
Engine Anti-Ice System	3.20.5
Engine Anti-Ice System Operation	3.20.5
Engine Anti-Ice System Schematic	3.20.6
Wing Anti-Ice System	3.20.7
Wing Anti-Ice System Operation	3.20.7
Wing Anti-Ice System Schematic	3.20.8

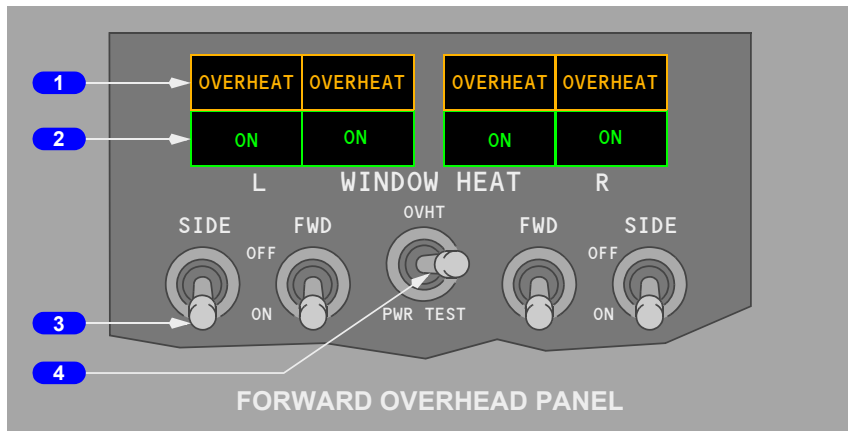

Intentionally
Blank

Window Heat Panel

1 Window OVERHEAT Lights

Illuminated (amber) – overheat condition is detected.

Note: OVERHEAT lights also illuminate if electrical power to window(s) is interrupted.

2 Window Heat ON Lights

Illuminated (green) – window heat is being applied to selected window(s).

Extinguished –

- switch is OFF, or
- an overheat is detected, or
- a system failure has occurred.

3 WINDOW HEAT Switches

ON – window heat is applied to selected window(s).

OFF – window heat not in use.

4 WINDOW HEAT Test Switch (spring-loaded to neutral)

OVHT – simulates an overheat condition.

PWR TEST – provides a confidence test.

Note: Refer to Supplementary Normal Procedures for Window Heat Test procedures.

Windshield/Foot Air Controls

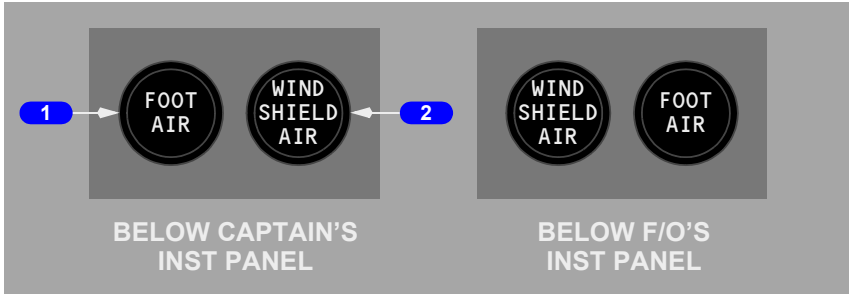

1 FOOT AIR Controls

PULL – supplies conditioned air to pilots' leg positions.

2 WINDSHIELD AIR Controls

PULL – supplies conditioned air to number 1 windows for defogging.

Windshield Wiper Selector Panel

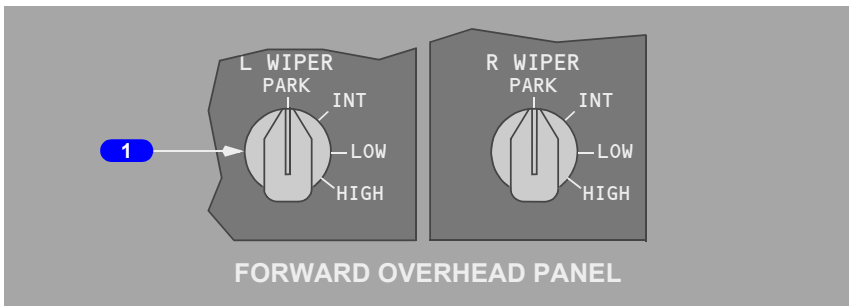

1 Windshield WIPER Selectors

PARK – turns off wiper motors and stows wiper blades.

INT – seven second intermittent operation.

LOW – low speed operation.

HIGH – high speed operation.

Probe Heat Panel

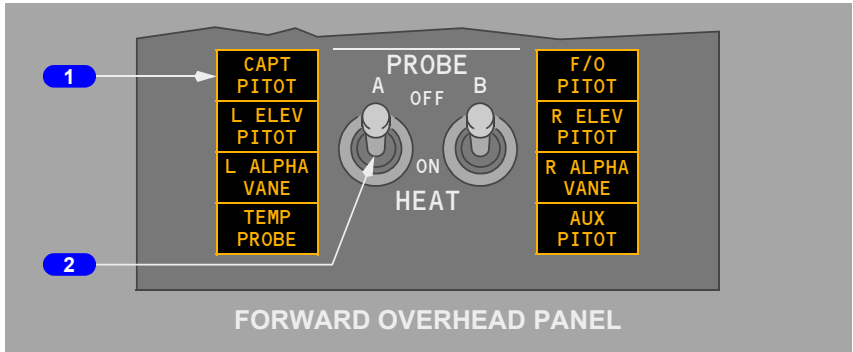

1 Probe Heat Lights

Illuminated (amber) – related probe not heated.

Note: If operating on standby power, probe heat lights do not indicate system status.

2 PROBE HEAT Switches

ON – power is supplied to heat related system.

OFF – power off.

Engine Anti-Ice Panel

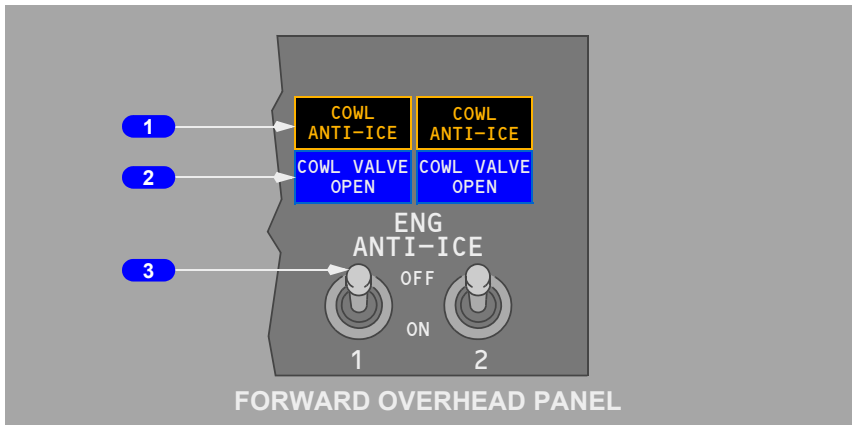

1 COWL ANTI-ICE Lights

Illuminated (amber) – indicates an overpressure condition in duct downstream of engine cowl anti-ice valve.

2 COWL VALVE OPEN Lights

Illuminated (blue) –

- bright – related cowl anti-ice valve is in transit, or, cowl anti-ice valve position disagrees with related ENGINE ANTI-ICE switch position
- dim – related cowl anti-ice valve is open (switch ON).

Extinguished – related cowl anti-ice valve is closed (switch OFF).

3 ENGINE ANTI-ICE Switches

ON –

- related engine anti-ice valve is open
- stick shaker logic is set for icing conditions.

OFF –

- related engine anti-ice valve is closed
- stick shaker logic returns to normal if wing anti-ice has not been used in flight.

Thermal Anti-Ice Indication

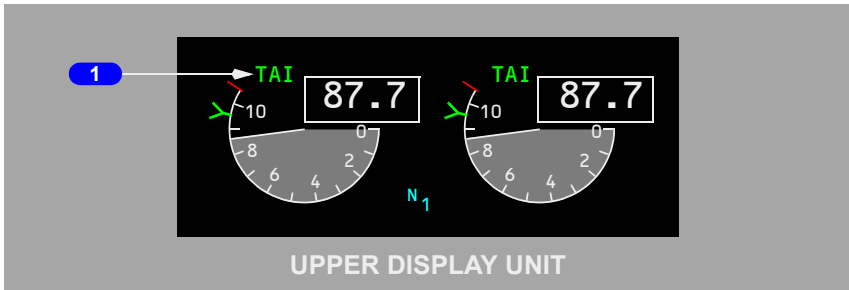

1 Thermal Anti-Ice Indications

Illuminated –

- Green – cowl anti-ice valve(s) open
- Amber – cowl anti-ice valve is not in position indicated by related engine anti-ice switch.

Wing Anti-Ice Panel

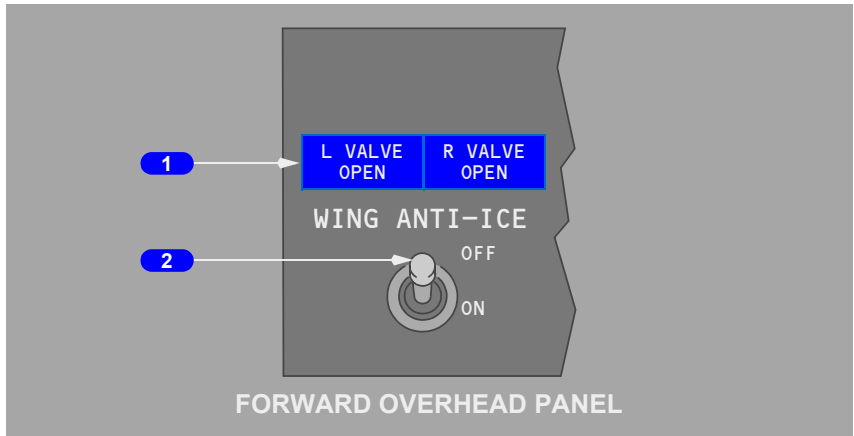

1 Wing Anti-Ice VALVE OPEN Lights

Illuminated (blue) –

- bright – related wing anti-ice control valve is in transit, or, related wing anti-ice control valve position disagrees with WING ANTI-ICE switch position
- dim – related wing anti-ice control valve is open (switch ON).

Extinguished – related wing anti-ice control valve is closed (switch OFF).

2 WING ANTI-ICE Switch

OFF – wing anti-ice control valves are closed.

ON (in the air) –

- wing anti-ice control valves are open
- stick shaker logic is set for icing conditions.

Note: Stick shaker logic remains set for icing conditions for the remainder of the flight, regardless of subsequent WING ANTI-ICE switch position.

ON (on the ground) –

- wing anti-ice control valves open if thrust on both engines is below takeoff warning setting and temperature inside both distribution ducts is below thermal switch activation temperature
- control valves close if either engine thrust is above takeoff warning setting or thermal switch is activated in either distribution duct. Switch remains ON
- switch trips OFF at lift-off.



Intentionally
Blank

Anti-Ice, Rain System Description

Chapter 3 Section 20

Introduction

Thermal anti-icing (TAI), electrical anti-icing, and windshield wipers are the systems provided for ice and rain protection.

The anti-ice and rain systems include:

- Flight Deck Window Heat
- Windshield Wipers
- Probe and Sensor Heat
- Engine Anti-Ice System
- Wing Anti-Ice System

Anti-Ice Components Diagram

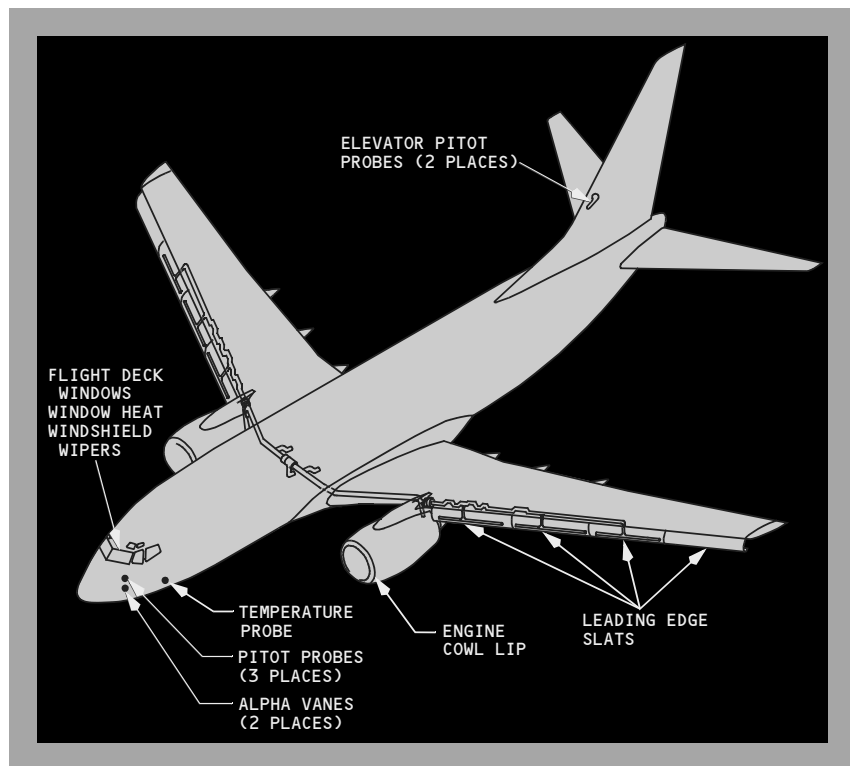

Flight Deck Window Heat

YA371 - YA376, YC201 - YC206, YE321 - YE326

Flight deck window numbers 1, 2, 4 and 5 consist of glass panes laminated to each side of a vinyl core. Flight deck window number 4 has an additional vinyl layer and acrylic sheet laminated to the inside surface. Flight deck window number 3 consists of two acrylic panes separated by an air space.

YA371 - YA376, YC201 - YC206, YE321 - YE326

A conductive coating on the outer glass pane of window numbers 1 and 2 permits electrical heating to prevent ice build-up and fogging. A conductive coating on the inner glass pane of window numbers 4 and 5 permits electrical heating to prevent fogging. Window number 3 is not electrically heated.

YA377, YC207

Flight deck window numbers 1 and 2 consist of glass panes laminated to each side of a vinyl core. Flight deck window number 3 consists of two acrylic panes separated by an air space.

YA377, YC207

A conductive coating on the outer glass pane of window numbers 1 and 2 permits electrical heating to prevent ice build-up and fogging. Window number 3 is not electrically heated.

Flight Deck Window Heat Operation

YA371 - YA376, YC201 - YC206, YE321 - YE326

The FWD WINDOW HEAT switches control heat to window No. 1. The SIDE WINDOW HEAT switches control heat to window number 2, 4, and 5.

YA371 - YA376, YC201 - YC206, YE321 - YE326

Temperature controllers maintain window numbers 1 and 2 at the correct temperature to ensure maximum strength of the windows in the event of bird impact. Power to window numbers 1 and 2 is automatically removed if an overheat condition is detected. A thermal switch located on window 5 opens and closes to maintain the correct temperature of window numbers 4 and 5.

YA377, YC207

The FWD WINDOW HEAT switches control heat to window No. 1. The SIDE WINDOW HEAT switches control heat to window numbers 2.

YA377, YC207

Temperature controllers maintain window numbers 1 and 2 at the correct temperature to ensure maximum strength of the windows in the event of bird impact. Power to window numbers 1 and 2 is automatically removed if an overheat condition is detected.

Flight Deck Window Heat Schematic

YA371 - YA376, YC201 - YC206, YE321 - YE326

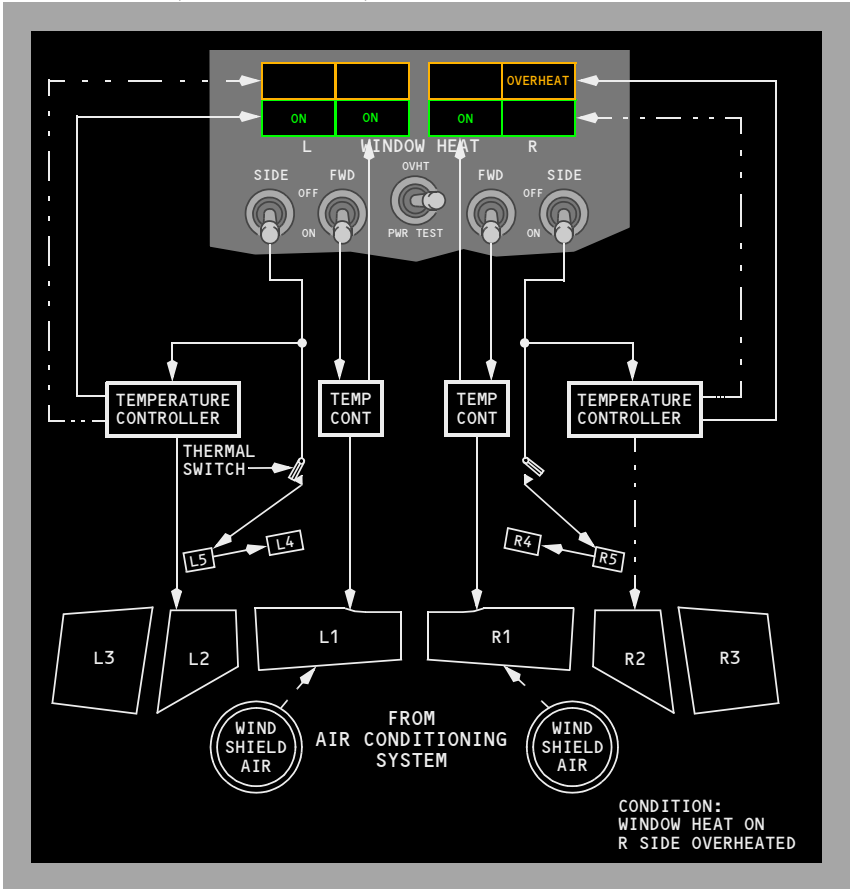

YA377, YC207

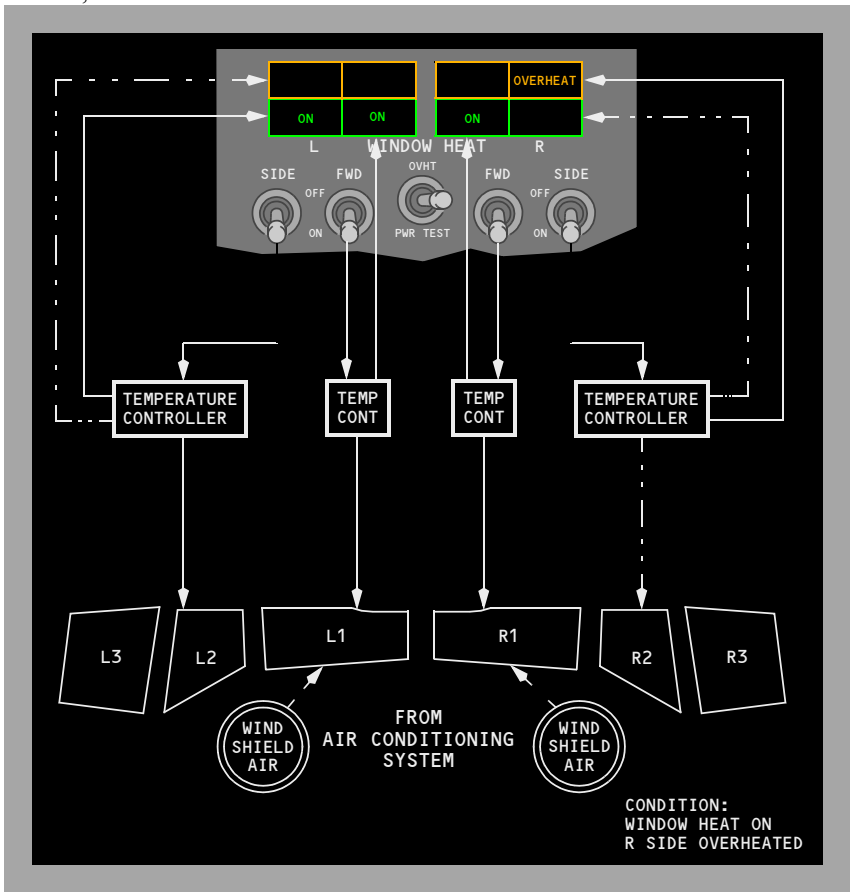

Windshield Wipers

The rain removal system for the forward windows consists of windshield wipers and a permanent rain repellent coating on the windows.

CAUTION: Windshield scratching will occur if the windshield wipers are operated on a dry windshield.

Probe and Sensor Heat

Pitot probes, the total air temperature probe and the alpha vanes are electrically heated. Static ports are not heated. When operating on standby power, only the captain's pitot probe is heated, however, the CAPT PITOT light does not illuminate for a failure.

Note: The pitot probe for standby airspeed is not heated when the airplane is on standby power.

Engine Anti-Ice System

Engine bleed air thermal anti-icing prevents the formation of ice on the engine cowl lip. Engine anti-ice operation is controlled by individual ENG ANTI-ICE switches. The engine anti-ice system may be operated on the ground and in flight.

Engine Anti-Ice System Operation

Each cowl anti-ice valve is electrically controlled and pressure actuated. Positioning the ENG ANTI-ICE switches to ON:

- allows engine bleed air to flow through the cowl anti-ice valve for cowl lip anti-icing
- sets stall warning logic for icing conditions.

Note: Stall warning logic adjusts stick shaker and minimum maneuver speed bars on airspeed indications. FMC displayed VREF is not adjusted automatically.

Note: Stall warning logic, airspeed indications, and minimum maneuver speeds on the airspeed indicator return to normal when engine anti-ice is positioned OFF if wing anti-ice has not been used in flight.

If the cowl anti-ice valve fails to move to the position indicated by the ENG ANTI-ICE switch, the COWL VALVE OPEN light remains illuminated bright blue and an amber TAI indication illuminates on the CDS after a short delay.

The amber COWL ANTI-ICE light illuminates due to excessive pressure in the duct leading from the cowl anti-ice valve to the cowl lip.

Engine Anti-Ice System Schematic

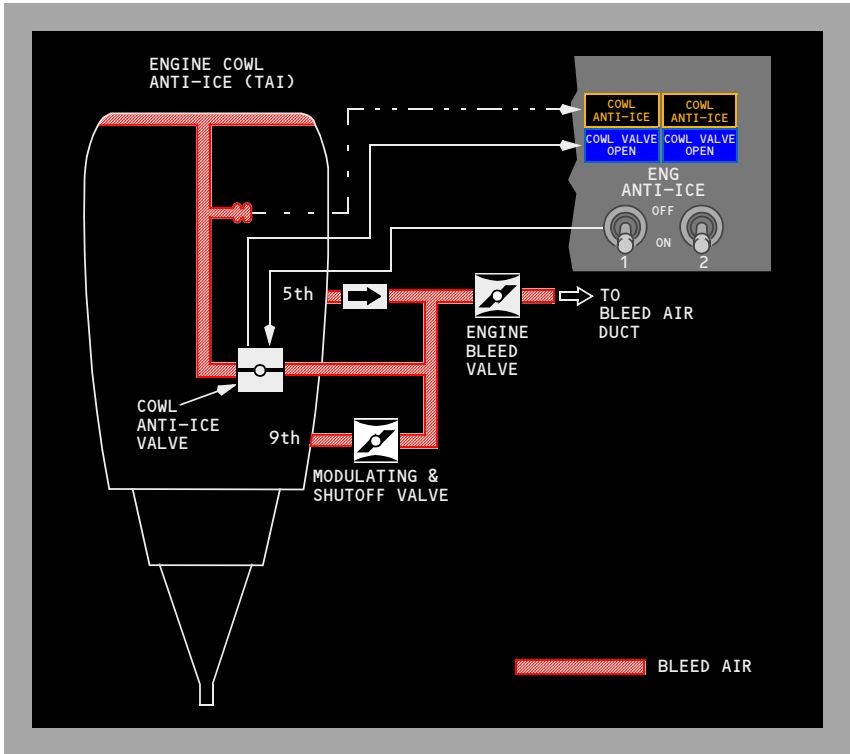

Wing Anti-Ice System

The wing anti-ice system provides protection for the three inboard leading edge slats by using bleed air. The wing anti-ice system does not include the leading edge flaps or the outboard leading edge slats.

The wing anti-ice control valves are AC motor-operated. With a valve open, bleed air flows to the three leading edge inboard slats, and is then exhausted overboard. The wing anti-ice system is effective with the slats in any position.

Wing Anti-Ice System Operation

On the ground, positioning the WING ANTI-ICE switch ON opens both control valves if thrust on both engines is below the setting for takeoff warning activation and the temperature inside both wing distribution ducts is less than the thermal switch activation temperature.

Both valves close if either engine thrust is above the takeoff warning setting or either temperature sensor senses a duct overtemperature. The valves automatically reopen if thrust on both engines is reduced and both temperature sensors are cool.

With the air/ground sensor in the ground mode and the WING ANTI-ICE switch ON, the switch remains in the ON position regardless of control valve position. The WING ANTI-ICE switch automatically trips OFF at lift-off when the air/ground sensor goes to the air mode.

Positioning the WING ANTI-ICE switch to ON in flight:

- opens both control valves
- sets stall warning logic for icing conditions.

Note: Stall warning logic adjusts stick shaker/minimum maneuver speed bars on airspeed indications. FMC displayed VREF is not adjusted automatically.

Note: Stall warning logic remains set for icing conditions for the remainder of the flight, regardless of subsequent WING ANTI-ICE switch position.

Valve position is monitored by the blue VALVE OPEN lights. Duct temperature and thrust setting logic are disabled and have no affect on control valve operation in flight.

Wing Anti-Ice System Schematic

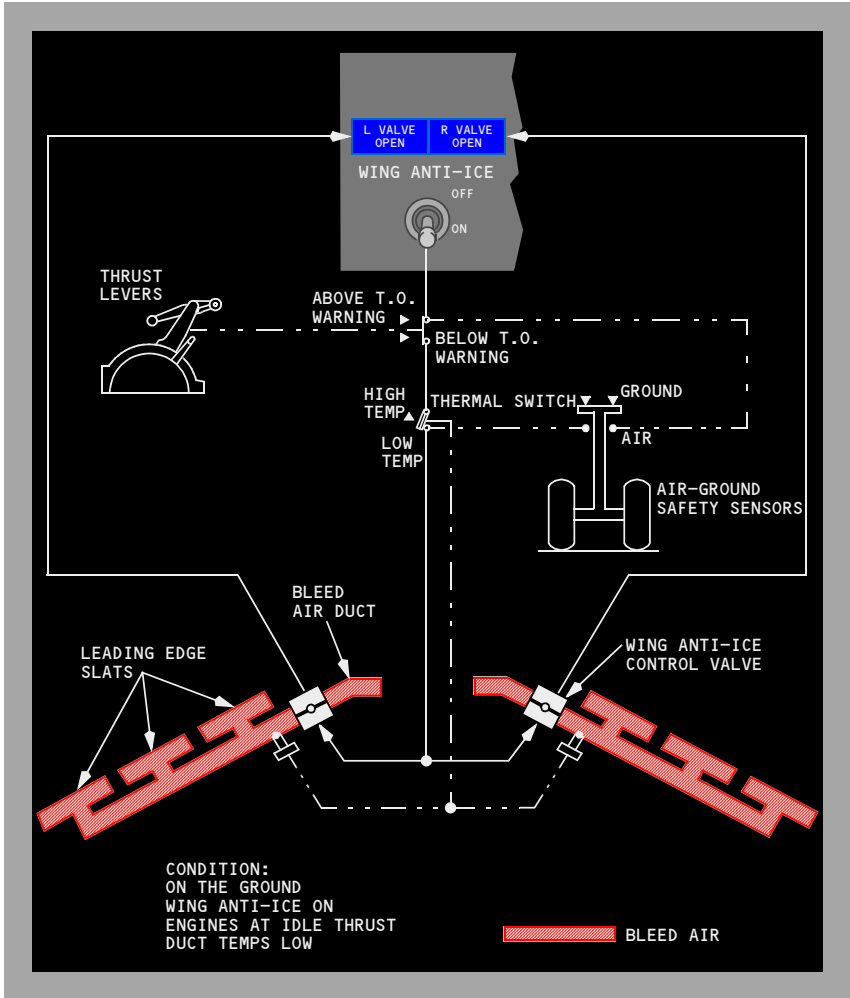



Automatic Flight

Chapter 4

Table of Contents

Section 0

Controls and Indicators **4.10.1**

 Mode Control Panel (MCP) 4.10.1

 Speed Controls 4.10.1

 Vertical Navigation 4.10.4

 Lateral Navigation 4.10.10

 Autopilot / Flight Director 4.10.15

 Autopilot / Autothrottle Controls 4.10.18

 Autopilot / Autothrottle Indicators 4.10.19

 Thrust Mode Display 4.10.20

 Flight Mode Annunciations (FMAs) 4.10.22

System Description **4.20.1**

 General 4.20.1

 Autopilot Flight Director System (AFDS) 4.20.1

 MCP Mode Selector Switches 4.20.1

 Autopilot Engagement Criteria 4.20.2

 Autopilot Disengagement 4.20.2

 AFS Failures 4.20.2

 Flight Director Display 4.20.3

 AFDS Status Annunciation 4.20.4

 AFDS Flight Mode Annunciations 4.20.4

 Autopilot Control Wheel Steering 4.20.6

 Autothrottle System 4.20.7

 Autothrottle Engagement 4.20.8

 Autothrottle Disengagement 4.20.8

 Automatic Flight Operations 4.20.9

 Automatic Flight Takeoff and Climb 4.20.9

 Automatic Flight Takeoff Profile 4.20.11

 Automatic Flight En Route 4.20.12

 Automatic Flight Approach and Landing 4.20.13



737 Flight Crew Operations Manual

Automatic Flight Approach Profile	4.20.16
Go-Around	4.20.18
Automatic Flight Go-Around Profile	4.20.21
AFS Operation in Windshear	4.20.22
General	4.20.22
Takeoff or Go-Around	4.20.23
Approach and Landing	4.20.23
Command Speed Limiting and Reversion Modes	4.20.23
Command Speed Limiting	4.20.23
Reversion Modes	4.20.24

**Automatic Flight
Controls and Indicators**

**Chapter 4
Section 10**

Mode Control Panel (MCP)

YA372 - YE326



YA371



Speed Controls

YA372 - YE326

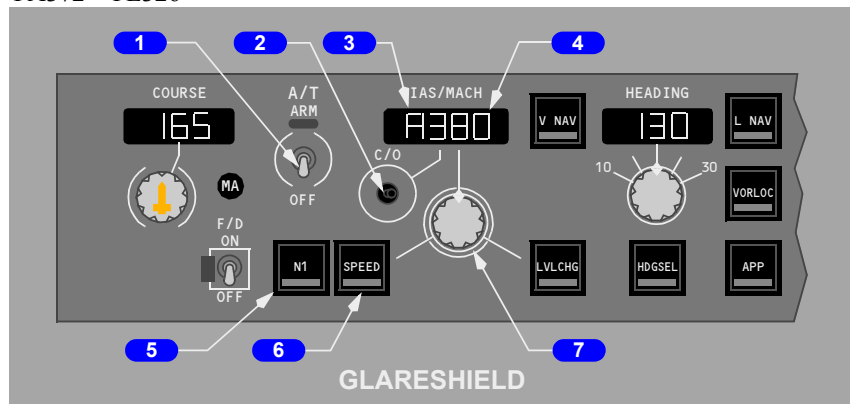

YA371

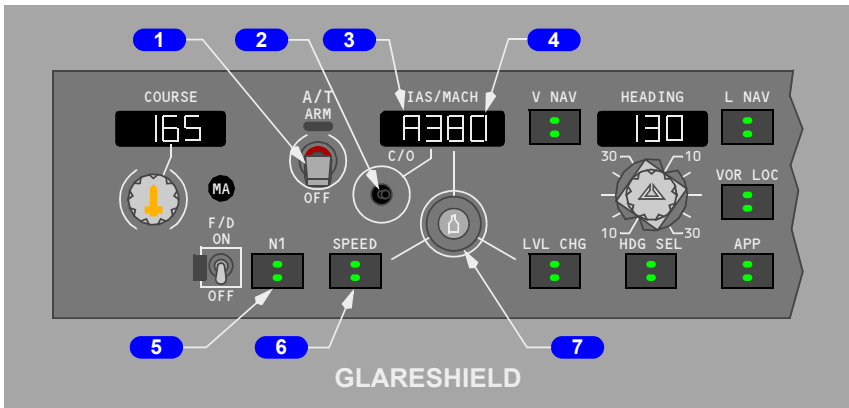

1 Autothrottle (A/T) ARM Switch

ARM – Arms A/T for engagement. Magnetically held at ARM. A/T engages automatically when following AFDS modes are engaged:

- LVL CHG
- ALT ACQ
- V/S
- VNAV
- ALT HOLD
- G/S capture
- TO/GA.

The indicator light illuminates green when A/T ARM switch is in the ARM position.

OFF – disengages A/T and prevents A/T engagement.

2 Changeover (C/O) Switch

Push –

- changes IAS/MACH display between IAS and MACH
- automatic changeover occurs at approximately FL260.

3 MCP Speed Condition Symbols

Overspeed or underspeed limiting symbol appears when commanded speed cannot be reached.

Underspeed limiting (flashing character “A”) – minimum speed

Overspeed limiting (flashing character “8”) –

- Vmo or Mmo limit
- landing gear limit
- flap limit.

4 IAS/MACH Display

Displays speed selected by IAS/MACH selector

- display is blank when:
 - VNAV mode engaged
 - A/T engaged in FMC SPD mode
 - during 2 engine AFDS go-around
- displays 100 knots when power is first applied
- display range is:
 - 100 KIAS – Vmo in 1 knot increments
 - .60M – Mmo in .01M increments.

5 N1 Switch

Push – (light not illuminated)

- engages A/T in N1 mode if compatible with AFDS modes already engaged
- illuminates N1 switch light
- annunciates N1 autothrottle mode.

Push – (light illuminated)

- deselects N1 mode and extinguishes switch light
- engages autothrottles in ARM mode.

N1 Mode

- A/T maintains thrust at N1 limit selected from FMC CDU. N1 mode engaged manually by pushing N1 switch if N1 mode is compatible with existing AFDS modes. N1 mode engages automatically when:
 - engaging LVL CHG in climb (except during inhibit period for 2 1/2 minutes after lift-off)
 - engaging VNAV in climb.

6 SPEED Switch

Push – (light not illuminated)

- engages A/T in SPEED mode if compatible with engaged AFDS modes
- illuminates SPEED switch light
- annunciates MCP SPD autothrottle mode
- maintains speed in MCP IAS/MACH display.

Push – (light illuminated)

- deselected speed mode and extinguishes switch light
- engages A/T in ARM mode.

Speed Mode

Autothrottle holds speed in IAS/MACH display or a performance or limit speed. Speed mode engaged manually by pushing SPEED switch if speed mode is compatible with existing AFDS modes. Speed mode engages automatically when:

- ALT ACQ engages
- ALT HOLD engages
- V/S engages
- G/S capture occurs.

A/T does not set thrust above displayed N1 limit, however, A/T can exceed N1 value manually set by N1 Manual Set Knob.

7 IAS/MACH Selector

Rotate –

- sets speed in IAS/MACH display and positions airspeed cursor
- selected speed is reference speed for AFDS and A/T
- not operative when IAS/MACH display is blank.

Vertical Navigation

YA372 - YE326

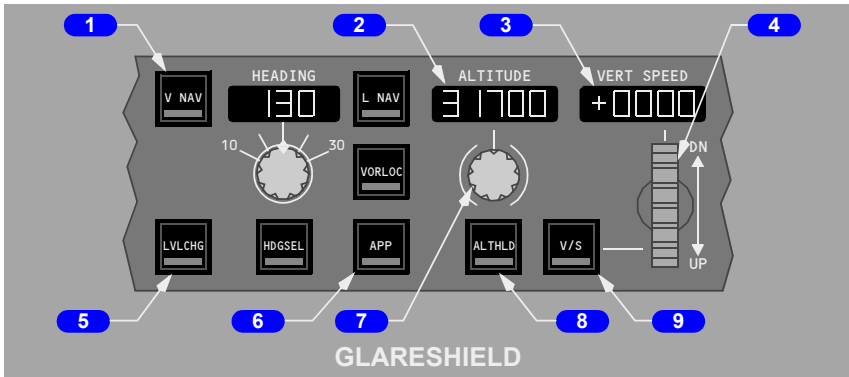

YA371

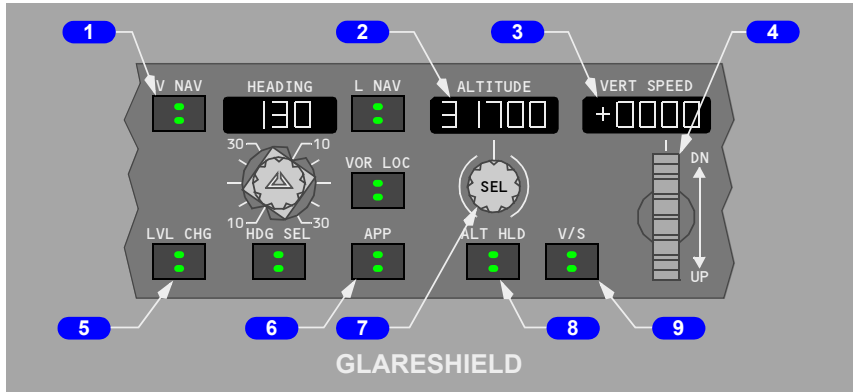

1 VNAV Switch

Push –

- VNAV switch light illuminates
- pitch mode annunciates VNAV SPD, VNAV PTH
- A/T mode annunciates FMC SPD, N1, RETARD, or ARM
- IAS/MACH display blanks and airspeed cursors positioned to FMC commanded airspeed.

VNAV Mode

The FMC commands AFDS pitch and autothrottle to fly vertical profile selected on FMC CDUs. Profile includes climb, cruise, descent, speeds, and can also include waypoint altitude constraints.

Note: If the airplane is between the FMC target altitude (depicted on the RTE LEGS page for the active waypoint) and the manually entered MCP target altitude, VNAV will not engage. To enable VNAV, adjust the FMC or MCP target altitude as appropriate.

Climb –

- autothrottle holds FMC thrust limit
- AFDS holds FMC target speed
- automatic level-off occurs at MCP altitude or VNAV altitude, whichever is reached first
 - VNAV constrained level-off annunciates VNAV PTH.

Cruise –

- autothrottle holds FMC target speed
- AFDS holds FMC altitude
- selecting a lower MCP altitude arms FMC to automatically begin descent upon arrival at FMC top of descent point.

Descent –

- VNAV SPD descent
 - autothrottle holds idle
 - AFDS holds FMC target speed.
- VNAV PTH descent
 - autothrottle holds idle but can command FMC SPD mode if ground speed becomes too low to maintain FMC vertical path
 - AFDS tracks FMC descent path.
- automatic level-off occurs at MCP altitude or VNAV altitude, whichever is reached first
 - VNAV constrained altitude annunciates VNAV PTH.

Inhibited below 400 ft RA or if performance initialization not complete.

VNAV mode is terminated by any one of the following:

- selecting another pitch mode
- glideslope capture
- reaching end of LNAV route
- transition of glideslope intercept waypoint if G/S is armed
- crosstrack deviation exceeds twice the RNP value during PTH descent for an active leg with a database vertical angle and LNAV not engaged

In the event of glideslope intercept waypoint transition, VNAV can be re-engaged.

When the pitch mode changes from VNAV SPD to ALT ACQ during an intermediate level off, the autothrottle will command a target IAS rather than Mach number. This is valid even at altitudes above the IAS/Mach changeover. If the climb is resumed in LVL CHG or V/S, the airspeed window opens at the target IAS which may result in an overspeed condition.

2 ALTITUDE Display

Displays selected altitude

- displayed altitude is reference for altitude alerting and automatic level-offs
- altitude range is 0 to 50,000 feet in 100 foot increments
- displays previously selected altitude when power first applied.

3 Vertical Speed (VERT SPEED) Display

Displays:

- blank when V/S mode not active
- present V/S when V/S mode is engaged with V/S switch
- selected V/S when V/S set with thumbwheel
- range is -7900 to +6000 fpm.

Display increments are:

- 50 fpm if V/S is less than 1000 fpm
- 100 fpm if V/S is 1000 fpm or greater.

4 Vertical Speed Thumbwheel

Rotate –

- DN –
 - sets vertical speed in VERT SPEED display
 - increases rate of descent or reduces rate of ascent.
- UP –
 - sets vertical speed in VERT SPEED display
 - increases rate of ascent or reduces rate of descent.

5 Level Change (LVL CHG) Switch

Push –

- LVL CHG switch light illuminates
- pitch mode annunciates MCP SPD for climb or descent
- autothrottle mode annunciates N1 for climb and RETARD followed by ARM for descent
- IAS/MACH display and airspeed cursors display target speed.

LVL CHG Mode

The LVL CHG mode coordinates pitch and thrust commands to make automatic climbs and descents to preselected altitudes at selected airspeeds.

A LVL CHG climb or descent is initiated by:

- selecting a new altitude
- pushing LVL CHG switch
- setting desired airspeed.

Climb –

- autothrottle holds limit thrust
- AFDS holds selected airspeed.

Descent –

- autothrottle holds idle thrust
- AFDS holds selected airspeed.

Airspeed –

- if a speed mode is active when LVL CHG is engaged, this speed is retained as target speed
- if a speed mode is not active when LVL CHG is engaged, existing speed becomes target speed
- speed can be changed with MCP IAS/MACH Selector.

The LVL CHG mode is inhibited after glideslope capture.

6 Approach (APP) Switch

(See Lateral Navigation)

7 Altitude Selector (SEL)

Rotate –

- sets altitude in ALTITUDE display in 100 foot increments
- arms V/S mode if rotated while in ALT HOLD at selected altitude.

8 Altitude Hold (ALT HLD) Switch

Push –

- engages ALT HOLD command mode
- commands pitch to hold uncorrected barometric altitude at which switch was pressed
- annunciates ALT HOLD pitch mode and illuminates ALT HLD switch light.

Altitude Hold Command Mode

ALT HOLD mode commands pitch to hold either:

- MCP selected altitude
 - pitch mode annunciates ALT HOLD
 - ALT HLD switch light extinguishes.
- uncorrected barometric altitude at which ALT HLD switch was pressed if not at MCP selected altitude
 - pitch mode annunciates ALT HOLD
 - ALT HLD switch light illuminates.

737 Flight Crew Operations Manual

When in ALT HOLD at selected MCP altitude:

- selecting a new MCP altitude illuminates the ALT HLD switch light and arms V/S mode
- LVL CHG, V/S, and VNAV climb and descent functions are inhibited until a new MCP altitude is selected.

ALT HOLD mode is inhibited after G/S capture.

The selected MCP altitude is referenced to:

- Captain's barometric altimeter setting for A A/P and F/D
- First Officer's barometric altimeter setting for B A/P and F/D.

Note: After ALT HOLD engages, changes in altimeter barometric settings do not change the selected altitude reference.

9 Vertical Speed (V/S) Switch

Push –

- arms or engages V/S command mode
- commands pitch to hold vertical speed
- engages A/T in speed mode to hold selected airspeed
- annunciates V/S pitch mode and illuminates V/S switch light.

Vertical Speed Command Mode

The V/S mode commands pitch to hold selected vertical speed and engages A/T in SPEED mode to hold selected airspeed. V/S mode has both an armed and an engaged state.

Engaged –

- annunciates V/S pitch mode
- vertical speed display changes from blank to present vertical speed
- desired vertical speeds can be selected with vertical speed thumbwheel.

V/S becomes armed if:

- pitch mode is ALT HLD at selected MCP altitude and
- new MCP altitude is selected (more than 100 feet from current altitude).

With V/S armed, V/S mode is engaged by moving vertical speed thumbwheel.

V/S mode automatically engages if ALT ACQ mode is engaged and a new MCP altitude is selected which is more than 100 feet different from previously selected altitude.

- vertical speeds can be selected which command flight toward or away from selected altitude.

Inhibited if:

- ALT HOLD mode is active at selected MCP altitude
- glideslope captured in APP mode.

Lateral Navigation

YA372 - YE326

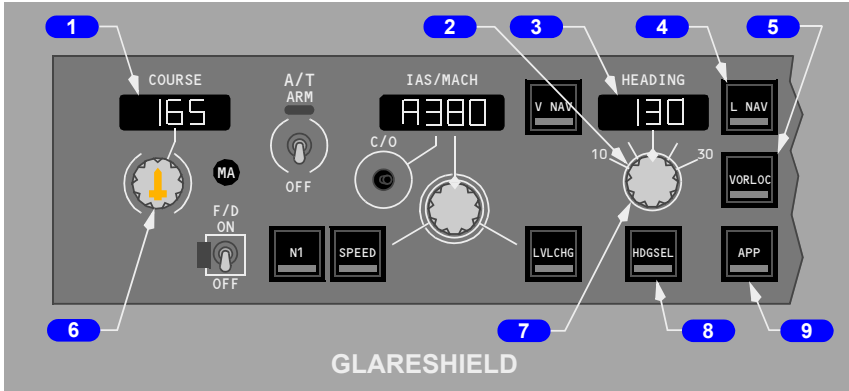

YA371

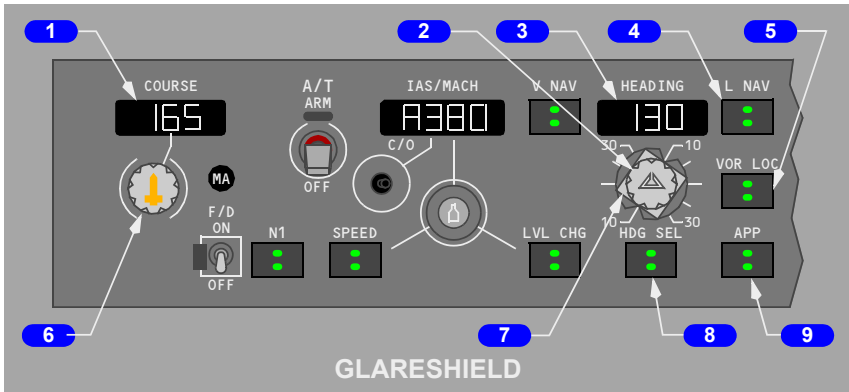

1 COURSE Display

Displays course set by course selector.

Note: Different courses and frequencies on two VHF NAV receivers can cause disagreement between Captain and FO F/D displays and affect A/P operation.

2 Heading Selector

Rotate –

- sets heading in HEADING display
- positions selected heading bugs on the DUs.

3 HEADING Display

Displays selected heading.

4 LNAV Switch

Push –

- commands AFDS roll to intercept and track the active FMC route
- annunciates LNAV as roll mode and illuminates LNAV switch light.

LNAV Mode

In LNAV mode, the FMC controls AFDS roll to intercept and track active FMC route. Active route is entered and modified through FMC CDUs and can include SIDs, STARs, and instrument approaches.

LNAV engagement criteria on the ground:

- origin runway in flight plan
- active route entered in FMC
- track of first leg within 5 degrees of runway heading
- LNAV selected prior to TO/GA. Once TO/GA is engaged, the LNAV switch light is extinguished until 400 feet AGL
 - LNAV guidance becomes active at 50 feet AGL
 - bank angle is limited to 8 degrees below 200 feet and 30 degrees above 200 feet AGL.

LNAV engagement criteria in flight:

- active route entered in FMC
- within 3 NM of active route, LNAV engagement occurs with any airplane heading
- outside of 3 NM, airplane must:
 - be on intercept course of 90 degrees or less
 - intercept route segment before active waypoint.

LNAV automatically disconnects for following reasons:

- reaching end of active route
- reaching a route discontinuity
- intercepting a selected approach course in VOR LOC or APP modes (VOR/LOC armed)
- selecting HDG SEL
- loss of capture criteria.

5 VOR Localizer (LOC) Switch

Push –

- commands AFDS roll to capture and track selected VOR or LOC course
- annunciates VOR/LOC armed or engaged as roll mode and illuminates VOR LOC switch light.

VOR LOC Mode

Pushing the VOR LOC switch selects VOR mode if a VOR frequency is tuned or selects LOC mode if a localizer frequency is tuned.

The VOR mode provides roll commands to track selected VOR course.

The LOC mode provides roll commands to track selected localizer course along inbound front course bearing.

The selected course can be intercepted while engaged in:

- LNAV
- HDG SEL
- CWS R if an autopilot is engaged in CMD.

The capture point is variable and depends on intercept angle and closure rate. Localizer capture occurs not later than 1/2 dot deviation. Course capture is indicated when VOR/LOC annunciation changes from armed to engaged.

While engaged in VOR or LOC modes:

- A autopilot and Captain's F/D use information from Captain's course selector and No. 1 VHF NAV receiver
- B autopilot and First Officer's F/D use information from First Officer's course selector and No. 2 VHF NAV receiver
- different courses and/or frequencies for two VHF NAV receivers can cause disagreement between the Captain's and First Officer's F/D displays and affect A/P operation.

Note: When a localizer frequency is selected, VHF NAV radios automatically switch from tail antenna to nose antenna when VOR/LOC is annunciated (armed or engaged). If antenna switching does not occur, LOC mode is inhibited.

Note: Localizer backcourse tracking is not available.

6 Course Selector

Sets course in COURSE display for related VHF NAV receiver, AFDS and DU. Two course selectors and COURSE displays are located on the MCP.

737 Flight Crew Operations Manual

Rotate Captain's course selector – provides selected course information to:

- A FCC
- No. 1 VHF NAV receiver
- Captain's course pointer and course deviation bar.

Note: In VOR LOC or APP mode, the A A/P and Captain's F/D use selected course and navigation data from the No. 1 VHF NAV receiver.

Rotate First Officer's course selector – provides selected course information to:

- B FCC
- No. 2 VHF NAV receiver
- First Officer's course pointer and course deviation bar.

Note: In VOR LOC or APP mode, B A/P and First Officer's F/D use selected course and navigation data from No. 2 VHF NAV receiver.

7 Bank Angle Selector

Rotate –

- sets maximum bank angle for AFDS operation in HDG SEL or VOR modes
- commanded bank angle can be selected at 10, 15, 20, 25, or 30 degrees.

8 Heading Select (HDG SEL) Switch

Push –

- engages HDG SEL command mode
- commands roll to follow selected heading
- annunciates HDG SEL as FMA roll mode and illuminates HDG SEL switch light.

Heading Select Command Mode

The HDG SEL mode commands roll to turn to and maintain heading shown in MCP HEADING display:

- initial selection commands turn in shortest direction toward selected heading bug
- after mode engagement, roll commands are given to turn in same direction as rotation of heading selector
- bank angle limit is established by bank angle selector
- HDG SEL mode automatically disengages upon capture of selected radio course in VOR LOC and APP modes (VOR/LOC armed).

9 Approach (APP) Switch

Push –

- illuminates APP switch light
- arms the AFDS for localizer and glideslope capture
- roll mode annunciates VOR/LOC armed
- pitch mode annunciates G/S armed
- enables engagement of both autopilots.

APP Mode

The approach mode arms AFDS to capture and track localizer and glideslope and can be engaged for dual or single autopilot operation.

One VHF NAV receiver must be tuned to an ILS frequency before approach mode can be engaged. With one VHF NAV receiver tuned, onside AFDS is enabled for guidance and operation.

For dual autopilot operation, both VHF NAV receivers must be tuned to the ILS frequency and both autopilots must be selected in CMD prior to 800 feet RA.

APP mode operation:

- localizer can be intercepted in HDG SEL, LNAV, or CWS R
YA371, YA372, YC201
- 1 CH annunciates in A/P Status Display after localizer capture
 - for single autopilot approach, 1 CH remains annunciates for entire approach
 - for dual autopilot approach, 1 CH annunciation extinguishes when second autopilot engages and FLARE armed is annunciates
- YA373 - YA377, YC202 - YE326
- SINGLE CH annunciates in A/P Status Display after localizer capture
 - for single autopilot approach, SINGLE CH remains annunciates for entire approach
 - for dual autopilot approach, SINGLE CH annunciation extinguishes when second autopilot engages and FLARE armed is annunciates
- glideslope capture occurs at 2/5 dot below glideslope
- APP switch light extinguishes after localizer and glideslope capture.

After localizer and glideslope capture, APP mode can be disengaged by:

- pushing a TO/GA switch
- disengaging autopilot(s) and turning off both F/D switches
- retuning the VHF NAV receiver.

737 Flight Crew Operations Manual

While engaged in the APP mode:

- the A autopilot and Captain’s F/D use information from Captain’s Course Selector and No. 1 VHF NAV receiver
- the B autopilot and First Officer’s F/D use information from First Officer’s Course Selector and No. 2 VHF NAV receiver
- different courses and/or frequencies for the two VHF NAV receivers can cause disagreement between Captain’s and First Officer’s F/D displays and affect A/P operation.

Note: After localizer and glideslope capture, CWS cannot be engaged by manually overriding pitch and roll. Manual override of autopilots causes autopilot disengagement.

Autopilot / Flight Director

Pushing a CMD or CWS switch engages related A/P in CMD or CWS and illuminates switch lights. A/P can operate in CMD, CWS, or a combination of CMD and CWS.

YA372 - YE326

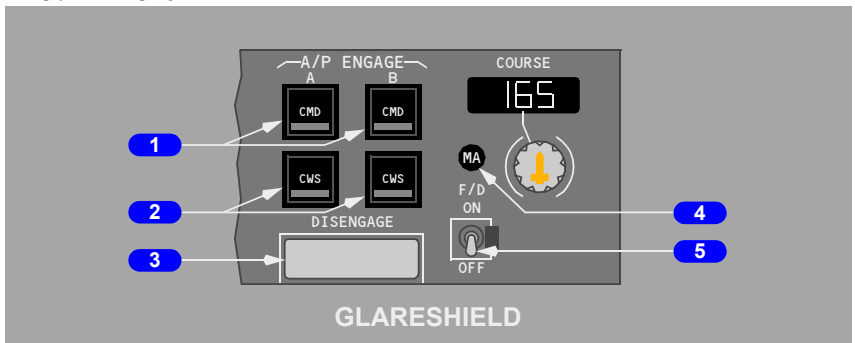

YA371

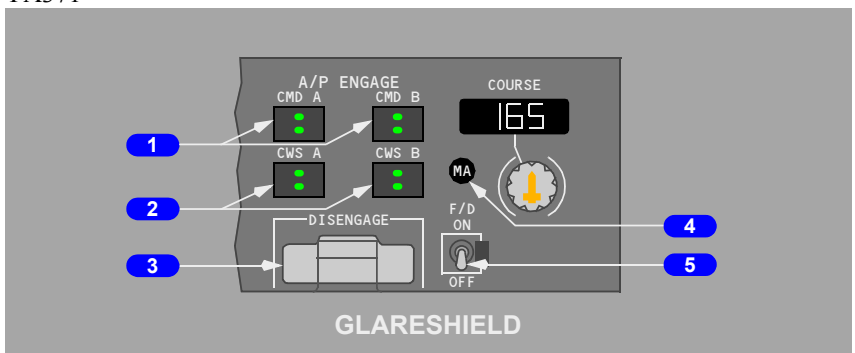

1 Command Engage (CMD ENGAGE) Switch (A or B):

Push –

- engages A/P
- enables all command modes
- displays CMD in A/P status display
- pushing an engage switch for second A/P, while not in approach mode, engages second A/P and disengages first A/P
- enables CWS operation
- CWS engages if:
 - pitch or roll mode not selected
 - pitch or roll mode deselected
 - pitch or roll mode manually overridden with control column force.

Note: After localizer and glideslope capture during a dual autopilot approach, CWS cannot be engaged by manually overriding pitch and roll. Manual override of autopilots causes autopilot disengagement.

- CWS engaged displays:
 - CWS P and/or CWS R in A/P status display
 - blank in pitch and/or roll mode FMA
- when approaching a selected altitude in CWS P, the pitch mode engages in ALT ACQ and ALT HOLD when reaching selected altitude
- when approaching a selected radio course in CWS R with VOR/LOC or approach mode armed, VOR/LOC engages when course is intercepted
- if pitch is manually overridden while in ALT HOLD and control force is released within 250 feet of selected altitude, A/P pitch mode engages in ALT ACQ and returns to selected altitude in ALT HOLD mode.

Note: During F/D only operation while pitch or roll commands are more than 1/2 scale from center, pushing a CMD A or B switch engages the A/P in CWS for pitch and/or roll and the related F/D bar(s) retract.

2 Control Wheel Steering Engage (CWS ENGAGE) Switch (A or B):

Push –

- engages A/P
- engages pitch and roll modes in CWS. Other pitch and roll modes not enabled
- displays CWS P and CWS R in A/P status display
- CMD not displayed in A/P status display
- F/Ds, if ON, display guidance commands and FD annunciates in A/P status display. A/P does not follow commands while in CWS

737 Flight Crew Operations Manual

- A/P pitch and roll controlled by pilot with control wheel pressure
- when control pressure released, A/P holds existing attitude. If aileron pressure released with 6 degrees or less bank, the A/P rolls wings level and holds existing heading. Heading hold feature inhibited:
 - below 1500 feet RA with gear down
 - after LOC capture in APP mode
 - after VOR capture with TAS 250 knots or less.

3 Autopilot Disengage (DISENGAGE) Bar

Pull down –

- exposes yellow background
- disengages both A/Ps
- prevents A/P engagement.

Lift up –

- conceals yellow background
- enables A/P engagement.

4 Master (MA) Flight Director Indicators (white letters)

If a F/D switch is ON, the light indicates which FCC is controlling the F/D modes.

- illuminated – related FCC is controlling F/D modes.
- extinguished – F/D modes are controlled from opposite FCC
- both lights illuminated – each FCC is controlling modes for related F/D.

5 Flight Director (F/D) Switch

Left F/D switch activates command bars on the Captain's attitude indicator. Right F/D switch activates command bars on the First Officer's attitude indicator.

ON –

- in flight with A/P ON and F/Ds OFF, turning a F/D switch ON engages F/D in currently selected A/P modes
- displays FD in A/P status display if A/P is OFF or engaged in CWS
- enables command bar display on related pilot's attitude indicator
- command bars are displayed if command pitch and/or roll modes are engaged
- on ground, arms pitch and roll modes for engagement in TO/GA and HDG SEL when TOGA switch is pushed.

OFF – command bars retract from related pilot's attitude indicator.

Autopilot / Autothrottle Controls

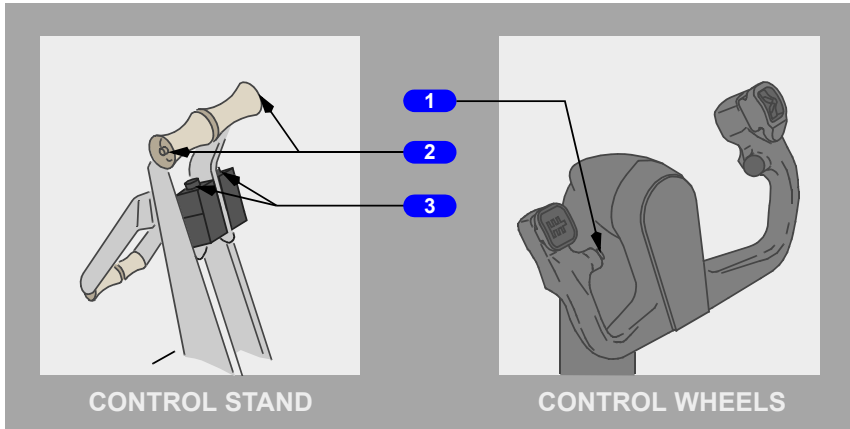

1 Autopilot Disengage Switch

Push –

- disengages both autopilots
- A/P disengage lights flash
- A/P disengage warning tone sounds for a minimum of two seconds
- second push extinguishes disengage lights and silences disengage warning tone
- if autopilot automatically disengages, extinguishes A/P Disengage lights and silences A/P warning tone.

2 Autothrottle Disengage Switches

Push –

- disengages autothrottle
- A/T disengage lights flash
- A/T ARM switch trips OFF
- second press extinguishes A/T disengage lights
- extinguishes A/T disengage lights after automatic A/T disengagement.

3 Takeoff/Go-Around (TO/GA) Switches

Push – engages AFDS and A/T in takeoff or go-around mode if previously armed.

Autopilot / Autothrottle Indicators

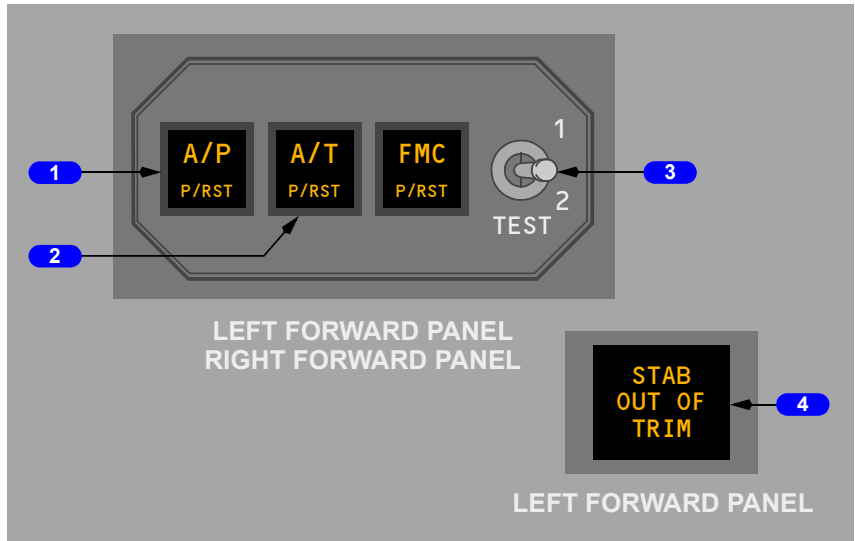

1 Autopilot (A/P) Disengage Light

Illuminated (red) –

- flashes and tone sounds when autopilot has disengaged
- reset by pushing either disengage light or either A/P disengage switch
- steady for any of following conditions:
 - stabilizer out of trim below 800 feet RA on dual channel approach
 - ALT ACQ mode inhibited during A/P go-around if stabilizer not trimmed for single A/P operation
 - disengage light test switch held in position 2
 - automatic ground system tests fail.

Illuminated (amber) –

- steady – disengage light test switch held in position 1.
- flashing – A/P automatically reverts to CWS pitch or roll while in CMD. Resets by pushing either light or selecting another mode.

2 Autothrottle (A/T) Disengage Light

Illuminated (red) –

- flashing – autothrottle has disengaged
- steady – disengage light test switch held in position 2.

Illuminated (amber) –

- steady – disengage light test switch held in position 1
- flashing – indicates A/T airspeed error under following conditions:
 - inflight
 - flaps not up
 - airspeed differs from commanded value by +10 or -5 knots and is not approaching commanded value.

3 Disengage Light Test (TEST) Switch

TEST 1 – illuminates autopilot/autothrottle disengage and FMC alert lights steady amber.

TEST 2 – illuminates autopilot/autothrottle disengage lights steady red and FMC alert light steady amber.

Spring-loaded to center position.

4 Stabilizer Out Of Trim (STAB OUT OF TRIM) Light

Operates only with autopilot engaged. Remains extinguished with autopilot not engaged.

Illuminated (amber) – autopilot not trimming stabilizer properly.

Thrust Mode Display

YA371, YA372, YC201

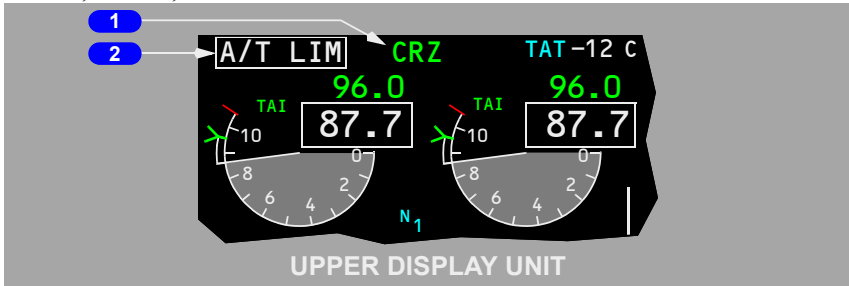

737 Flight Crew Operations Manual

YA373 - YA377, YC202 - YE326

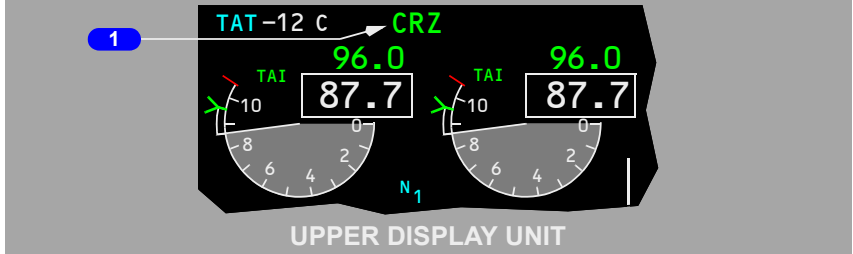

YA373 - YA377, YC202 - YE326

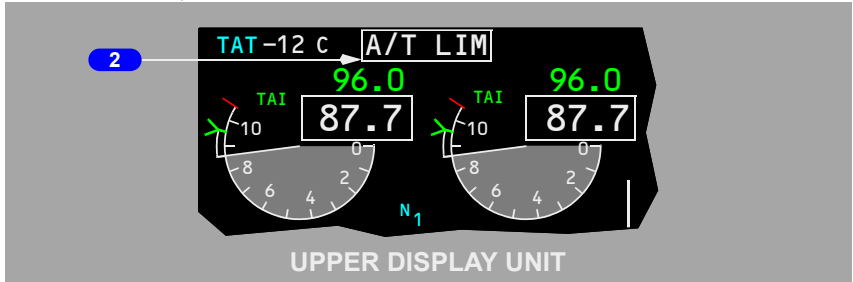

1 Thrust Mode Display

N1 limit reference is the active N1 limit for autothrottle and manual thrust control. N1 limit reference is also displayed by N1 reference bugs with N1 SET control in AUTO position.

N1 limit reference is normally calculated by the FMC.

Thrust mode display annunciations are:

- TO – takeoff
- R-TO – reduced takeoff
- R-CLB – reduced climb
- CLB – climb
- CRZ – cruise
- G/A – go-around
- CON – continuous
- — – FMC not computing thrust limit.

Note: R-TO does not indicate the type of reduced takeoff. The N1 limit may be reduced due to the entry of an assumed temperature, a takeoff thrust derate or a combination of both assumed temperature and takeoff thrust derate.

2 Autothrottle Limit (A/T LIM) Indication

Illuminated (white) – the FMC is not providing the A/T system with N1 limit values. The A/T is using a degraded N1 thrust limit from the related EEC.

Flight Mode Annunciations (FMAs)

YA373 - YA377, YC202 - YE326

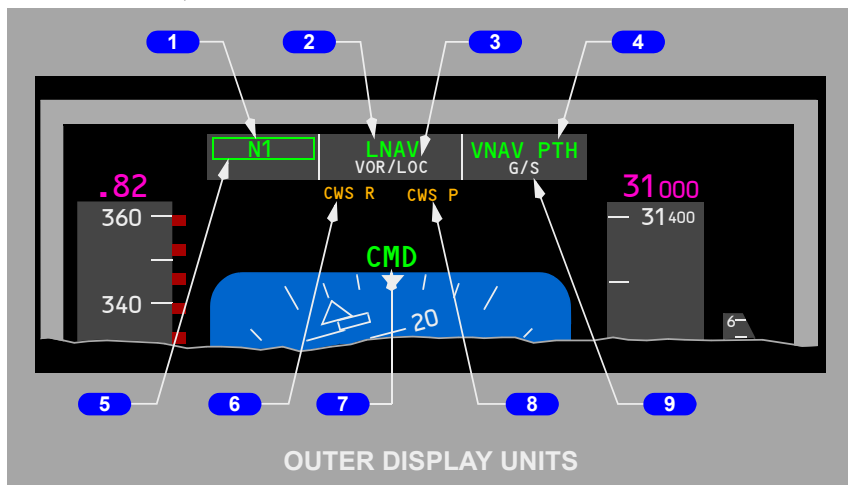

1 Autothrottle (A/T) Engaged Mode

- N1 (green)
- GA (green)
- Retard (green)
- FMC SPD (green)
- MCP SPD (green)
- THR HLD (green)
- ARM (white)

2 Roll Engaged Mode

- HDG SEL (green)
- VOR/LOC (green)
- LNAV (green)

3 Roll Armed Mode

- VOR/LOC (white)
 - LNAV VOR/LOC (white)
- YA373 - YA376, YC202 - YC206, YA377, YC207

737 Flight Crew Operations Manual

4 Pitch Engaged Mode

- TO/GA (green)
- V/S (green)
- MCP SPD (green)
- ALT/ACQ (green)
- ALT HOLD (green)
- G/S (green)
- FLARE (green)
- VNAV SPD (green)
- VNAV PTH (green)

5 Mode Highlight Change Symbol

A mode change highlight symbol (rectangle) is drawn around each pitch, roll, CWS, A/P status, and thrust engaged mode annunciation for a period of 10 seconds after each engagement.

6 CWS Roll Engaged

- CWS R (amber)

7 Autopilot Status

- CMD (green)
- SINGLE CH (amber)
- FD (green)

8 CWS Pitch Engaged

- CWS P (amber)

9 Pitch Armed Mode

- G/S (white)
- V/S (white)
- FLARE (white)
- G/S V/S (white)

YA371, YA372, YC201

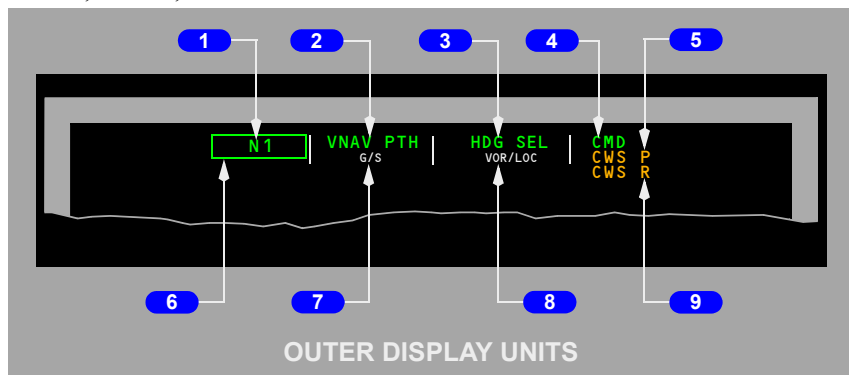

1 Autothrottle (A/T) Engaged Mode

- NI (green)
- GA (green)
- Retard (green)
- FMC SPD (green)
- MCP SPD (green)
- THR HLD (green)
- ARM (white)

2 Pitch Engaged Mode

- TO/GA (green)
- V/S (green)
- MCP SPD (green)
- ALT ACQ (green)
- ALT HOLD (green)
- G/S (green)
- FLARE (green)
- VNAV PTH (green)
- VNAV SPD (green)

3 Roll Engaged Mode

- HDG SEL (green)
- VOR/LOC (green)
- LNAV (green)

4 Autopilot Status

- CMD (green)
- SINGLE CH (amber)
- FD (green)

5 Mode Highlight Change Symbol

A mode change highlight symbol (rectangle) is drawn around each pitch, roll, CWS, A/P status, and thrust engaged mode annunciation for a period of 10 seconds after each engagement.

6 Pitch Armed Mode

- G/S (white)
- V/S (white)
- G/S V/S (white)
- FLARE (white)

7 Roll Armed Mode

- VOR/LOC (white)

8 CWS Roll Engaged

- CWS R (amber)



737 Flight Crew Operations Manual

9 CWS Pitch Engaged

- CWS P (amber)



Intentionally
Blank



General

The automatic flight system (AFS) consists of the autopilot flight director system (AFDS) and the autothrottle (A/T). The flight management computer (FMC) provides N1 limits and target N1 for the A/T and command airspeeds for the A/T and AFDS.

The AFDS and A/T are controlled using the AFDS mode control panel (MCP) and the FMC. Normally, the AFDS and A/T are controlled automatically by the FMC to fly an optimized lateral and vertical flight path through climb, cruise and descent.

AFS mode status is displayed on the flight mode annunciation on each pilot's primary display.

Autopilot Flight Director System (AFDS)

The AFDS is a dual system consisting of two individual flight control computers (FCCs) and a single mode control panel.

The two FCCs are identified as A and B. For A/P operation, they send control commands to their respective pitch and roll hydraulic servos, which operate the flight controls through two separate hydraulic systems.

For F/D operation, each FCC positions the F/D command bars on the respective attitude indicator.

MCP Mode Selector Switches

The mode selector switches are pushed to select desired command modes for the AFDS and A/T. The switch illuminates to indicate mode selection and that the mode can be deselected by pushing the switch again. While a mode is active, deselection can be automatically inhibited and is indicated by the switch being extinguished.

When engagement of a mode would conflict with current AFS operation, pushing the mode selector switch has no effect. All AFDS modes can be disengaged either by selecting another command mode or by disengaging the A/P and turning the F/Ds off.

Autopilot Engagement Criteria

Each A/P can be engaged by pushing a separate CMD or CWS engage switch. A/P engagement in CMD or CWS is inhibited unless both of the following pilot-controlled conditions are met:

- no force is being applied to the control wheel
- the STAB TRIM AUTOPILOT cutout switch is at NORMAL.

Only one A/P can be engaged at a given time unless the approach (APP) mode is engaged. Approach mode allows both A/Ps to be engaged at the same time. Dual A/P operation provides control through landing flare and touchdown or an automatic go-around.

In single A/P operation, full automatic flare and touchdown capability and A/P go-around capability are not available.

Autopilot Disengagement

The A/P automatically disengages when any of the following occurs:

- pushing either A/P disengage switch
- pushing either Takeoff/Go-around (TO/GA) switch with a single A/P engaged in CWS or CMD above 2000 feet RA with flaps not up or G/S engaged.
- pushing either TO/GA switch after touchdown with both A/Ps engaged in CMD
- pushing an illuminated A/P ENGAGE switch
- pushing the A/P DISENGAGE bar down
- activating either pilot's control wheel trim switch
- moving the STAB TRIM AUTOPILOT cutout switch to CUTOUT
- either left or right IRS system failure or FAULT light illuminated
- loss of electrical power or a sensor input which prevents proper operation of the engaged A/P and mode
- loss of respective hydraulic system pressure.

Note: Loss of the system A engine-driven hydraulic pump, and a heavy demand on system A, may cause A/P A to disengage.

AFS Failures

Power interruption or loss may cause disengagement of the AFDS and/or A/T. Re-engagement is possible after power is restored.

Dual channel A/P operation is possible only when two generators are powering the busses.

Two independent radio altimeters provide radio altitude to the respective FCCs. With a radio altimeter inoperative, the autopilot will disconnect two seconds after LOC and GS capture.

Flight Director Display

Turning a F/D switch ON displays command bars on the respective pilot's attitude indicator if command pitch and roll modes are engaged. If command pitch and roll modes are not engaged, the F/D command bars do not appear. The F/Ds can be operated with or without the A/P and A/T. F/D command modes can be used with an A/P engaged in CWS.

F/D commands operate in the same command modes as the A/P except:

- the takeoff mode is a F/D only mode
- dual F/D guidance is available for single engine operation
- the F/D has no landing flare capability. F/D command bars retract from view at approximately 50 feet RA on an ILS approach.

Normally, FCC A drives the captain's command bars and FCC B drives the first officer's command bars. With both F/D switches ON, the logic for both pilots' F/D modes is controlled by the master FCC, and both FMA displays show the same mode status.

The master FCC is indicated by illumination of the respective master (MA) F/D indicator light. The master FCC is determined as follows:

- with neither A/P engaged in CMD, the FCC for the first F/D turned on is the master
- with one or both A/Ps engaged in CMD, the FCC for the first A/P in CMD is the master FCC, regardless of which F/D is turned on first.

F/D modes are controlled directly from the respective FCC under certain conditions. This independent F/D operation occurs when neither A/P is engaged in CMD, both F/D switches are ON and one of the following mode conditions exists:

- APP mode engaged with LOC and G/S captured
- GA mode engaged and below 400 feet RA
- TO mode engaged and below 400 feet RA.

Independent F/D operation is indicated by illumination of both MA lights. When independent operation terminates, the MA light extinguishes on the slaved side.

If a generator is lost during a F/D TO or GA, or while in dual F/D APP mode below 800 feet, the FCC on the unaffected side positions the F/D command bars on both attitude indicators. If the F/D MA light on the affected side had been illuminated, it extinguishes upon electrical bus transfer.

AFDS Status Annunciation

The following AFDS status annunciations are displayed in the A/P status display located above the attitude indicator on the outboard display unit:

- CMD (one or both autopilots are engaged)
 - FD (the flight director is ON and the autopilot is either OFF or engaged in CWS)
 - CWS P (pitch mode engaged in CWS)
 - CWS R (roll mode engaged in CWS)
- YA371, YA372, YC201
- 1 CH (for single A/P ILS approach, annunciates after localizer capture and remains on for entire approach. For dual A/P ILS approach, annunciates after localizer capture and extinguishes after pitch monitor confidence test is successfully completed).
- YA373 - YA377, YC202 - YE326
- SINGLE CH (for single A/P ILS approach, annunciates after localizer capture and remains on for entire approach. For dual A/P ILS approach, annunciates after localizer capture and extinguishes after pitch monitor confidence test is successfully completed).

AFDS Flight Mode Annunciations

The flight mode annunciations are displayed just above the attitude indicator on the outboard display unit. The mode annunciations, from left to right, are:

YA371, YA372, YC201

- autothrottle
- pitch
- roll.

YA373 - YA377, YC202 - YE326

- autothrottle
- roll
- pitch.

Engaged or captured modes are shown at the top of the flight mode annunciation boxes in large green letters. Armed modes are shown in smaller white letters at the bottom of the flight mode annunciation boxes.

Autothrottle Modes

- N1 – the autothrottle maintains thrust at the selected N1 limit displayed on the thrust mode display, including full go-around N1 limit
- GA – the autothrottle maintains thrust at reduced go-around setting
- RETARD – displayed while autothrottle moves thrust levers to the aft stop. RETARD mode is followed by ARM mode

737 Flight Crew Operations Manual

- FMC SPD – the autothrottle maintains speed commanded by the FMC. The autothrottle is limited to the N1 value shown on the thrust mode display
- MCP SPD – the autothrottle maintains speed set in the MCP IAS/MACH display. The autothrottle is limited to the N1 value shown on the thrust mode display
- THR HLD – the thrust lever autothrottle servos are inhibited; the pilot can set the thrust levers manually
- ARM – no autothrottle mode engaged. The thrust lever autothrottle servos are inhibited; the pilot can set thrust levers manually. Minimum speed protection is provided

Pitch Modes

- TO/GA – Takeoff

Engaged for takeoff by turning both F/D switches ON and pushing either TO/GA switch. Both F/Ds must be ON to engage TO/GA prior to starting takeoff.

The AFDS commands pitch attitude in the following order:

- 10 degrees nose down until 60 knots IAS
- 15 degrees nose up after 60 knots IAS
- 15 degrees nose up after lift-off until a sufficient climb rate is acquired. Then, pitch is commanded to maintain MCP speed plus 20 knots.

TO/GA can also be engaged for takeoff with F/D switches OFF if a TO/GA switch is pushed after 80 knots IAS below 2000 feet AGL and prior to 150 seconds after lift-off.

- TO/GA – Go-around

Engaged for go-around by pushing the TO/GA switch under the following conditions:

- in flight below 2000 feet radio altitude
- in flight above 2000 feet radio altitude with flaps not up or G/S captured
- not in takeoff mode
- either F/D ON or OFF.

When engaged, the F/Ds command roll to hold the ground track, and 15 degrees nose up pitch. After reaching a programmed rate of climb, pitch commands the target airspeed for each flap setting based on maximum takeoff weight calculations.

- VNAV –

VNAV is engaged by pushing the VNAV switch. With a VNAV mode engaged, the FMC commands AFDS pitch and A/T modes to fly the vertical profile.

- VNAV SPD – the AFDS maintains the FMC speed displayed on the airspeed indicator and/or the CDU CLIMB or DESCENT pages

- VNAV PTH – the AFDS maintains FMC altitude or descent path with pitch commands.
- V/S (engaged) – commands pitch to hold selected vertical speed
- V/S (armed) – V/S mode can be engaged by moving Vertical Speed thumbwheel
- ALT ACQ – transition maneuver entered automatically from a V/S, LVL CHG, or VNAV climb or descent to selected MCP altitude. Engages but does not annunciate during VNAV transition
- ALT HOLD – commands pitch to hold MCP selected altitude or uncorrected barometric altitude at which ALT HOLD switch was pushed
- MCP SPD – pitch commands maintain IAS/MACH window airspeed or Mach
- G/S (armed) – the AFDS is armed for G/S capture
- G/S (engaged) – the AFDS follows the ILS glideslope
- FLARE (armed) – during a dual A/P ILS approach, FLARE is displayed after LOC and G/S capture and below 1500 feet RA. The second A/P couples with the flight controls and A/P go-around mode arms
- FLARE (engaged) – during a dual A/P ILS approach, flare engages at 50 feet radio altitude. FLARE accomplishes the autoland flare maneuver.

Roll Modes

- LNAV – the AFDS intercepts and tracks the active FMC route. Either of the following capture criteria must be met:
 - on any heading and within 3 NM of the active route segment
 - if outside of 3 NM of active route segment, airplane must be on an intercept course of 90 degrees or less and intercept the route segment before the active waypoint.
- HDG SEL – the airplane is turning to, or is on the heading selected in the MCP Heading Display
- VOR/LOC (armed) – AFDS is armed to capture selected VOR or LOC COURSE
- VOR/LOC (engaged) – AFDS tracks selected VOR course or tracks selected localizer course along the inbound front course bearing.

Autopilot Control Wheel Steering

CWS Engage Switch Selected

Pushing a CWS engage switch engages the A/P pitch and roll axes in the CWS mode and displays CWS P and CWS R on the FMAs.

With CWS engaged, the A/P maneuvers the airplane in response to control pressures applied by either pilot. The control pressure is similar to that required for manual flight. When control pressure is released, the A/P holds existing attitude.

737 Flight Crew Operations Manual

If aileron pressure is released with 6 degrees or less bank, the A/P rolls the wings level and holds existing heading. This heading hold feature with bank less than 6 degrees is inhibited when any of the following conditions exists:

- below 1,500 feet RA with the landing gear down
- after F/D VOR capture with TAS 250 knots or less
- after F/D LOC capture in the APP mode.

Pitch CWS with a CMD Engage Switch Selected

The pitch axis engages in CWS while the roll axis is in CMD when:

- a command pitch mode has not been selected or was deselected
- A/P pitch has been manually overridden with control column force. The force required for override is greater than normal CWS control column force. This manual pitch override is inhibited in the APP mode with both A/Ps engaged.

CWS P is annunciated on the FMAs while this mode is engaged. Command pitch modes can then be selected.

When approaching a selected altitude in CWS P with a CMD engage switch selected, CWS P changes to ALT ACQ. When at the selected altitude, ALT HOLD engages.

If pitch is manually overridden while in ALT HOLD at the selected altitude, ALT HOLD changes to CWS P. If control force is released within 250 feet of the selected altitude, CWS P changes to ALT ACQ, the airplane returns to the selected altitude, and ALT HOLD engages. If the elevator force is held until more than 250 feet from the selected altitude, pitch remains in CWS P.

Roll CWS with a CMD Engage Switch Selected

The roll axis engages in CWS while the pitch axis is in CMD when:

- a command roll mode has not been selected or was deselected
- A/P roll has been manually overridden with control wheel force. The force required for override is greater than the normal CWS control wheel force.

CWS R is annunciated on the FMAs while this mode is engaged.

CWS R with a CMD engage switch illuminated can be used to capture a selected radio course while the VOR/LOC or APP mode is armed. Upon intercepting the radial or localizer, the F/D and A/P annunciations change from CWS R to VOR/LOC engaged, and the A/P tracks the selected course.

Autothrottle System

The A/T system provides automatic thrust control from the start of takeoff through climb, cruise, descent, approach and go-around or landing. In normal operation, the FMC provides the A/T system with NI limit values.

The A/T moves the thrust levers with a separate servo motor on each thrust lever. Following manual positioning, the A/T may reposition the thrust levers to comply with computed thrust requirements except while in the THR HLD and ARM modes.

The A/T system operates properly with the EECs ON or in ALTN. In either case, the A/T uses the FMC N1 limits. During A/T operation, it is recommended that both EECs be ON or both be in ALTN, as this produces minimum thrust lever separation.

Autothrottle Engagement

Moving the A/T Arm switch to ARM, arms the A/T for engagement in the N1, MCP SPD or FMC SPD mode. The A/T Arm switch is magnetically held at ARM and releases to OFF when the A/T becomes disengaged.

A general summary of A/T mode engagement is as follows:

- A/T SPD or N1 modes automatically engage when AFDS command pitch modes become engaged
- engaging LVL CHG or VNAV climb modes automatically engages the A/T N1 mode
- engaging LVL CHG or VNAV descent modes automatically engages the A/T in RETARD and then ARM when thrust is at idle
- if not in a VNAV mode, engagement of ALT ACQ or ALT HOLD automatically engages the A/T in the MCP SPD mode; otherwise the A/T remains in FMC SPD
- engagement of G/S capture automatically engages the A/T in the MCP SPD mode
- alpha floor automatically engages the A/T when armed.

Autothrottle Disengagement

Any of the following conditions or actions disengages the A/T:

- moving the A/T Arm switch to OFF
- pushing either A/T Disengage switch
- an A/T system fault is detected
- two seconds have elapsed since landing touchdown
YA371
- thrust levers become separated more than 10 degrees during a dual channel approach after FLARE armed is annunciated
YA372 - YE326
- thrust levers become separated more than 10 degrees
YA371
- significant thrust difference along with control wheel roll input of 10 degrees or more, and flap position up through 10.

737 Flight Crew Operations Manual

YA372 - YE326

- significant thrust difference along with control wheel roll input of 10 degrees or more at any point throughout the entire flight envelope.

A/T disengagement is followed by A/T Arm switch releasing to OFF and flashing red A/T Disengage lights. The A/T Disengage lights do not illuminate when the A/T automatically disengages after landing touchdown.

Automatic Flight Operations

The phases of flight for automatic flight operations are:

- Takeoff and climb
- Enroute
- Approach and landing
- Go-around

Automatic Flight Takeoff and Climb

Takeoff is a flight director only function of the TO/GA mode. Flight director pitch and roll commands are displayed and the autothrottle maintains takeoff N1 thrust limit as selected from the FMC. The autopilot may be engaged after takeoff.

Both F/Ds must be ON to engage the takeoff mode prior to starting the takeoff. The F/D takeoff mode is engaged by pushing the TO/GA switch on either thrust lever. The FMAs display FD as the A/P status, TO/GA as the pitch mode, and HDG SEL as the roll mode.

During takeoff, pushing a TO/GA switch engages the autothrottle in the N1 mode. The A/T annunciation changes from ARM to N1 and thrust levers advance toward takeoff thrust.

The F/D can also be engaged in the takeoff mode with the F/D switches off. If a TO/GA switch is pushed after 80 knots below 2000 feet AGL and prior to 150 seconds after lift-off, the F/D command bars automatically appear for both pilots.

During takeoff, prior to 60 KIAS:

- the pitch command is 10 degrees nose down
- the roll command is HDG SEL
- the autothrottle is engaged in the N1 mode
- thrust levers advance until the engines reach takeoff thrust
- the FMAs display N1 for the autothrottle mode, TO/GA for the pitch mode, and HDG SEL for the roll mode.

At 60 knots, the F/D pitch commands 15 degrees nose up.

At 84 knots, the A/T mode annunciates THR HLD.

At lift-off:

- the pitch command continues at 15 degrees until sufficient climb rate is acquired. Pitch then commands MCP speed (normally V_2) plus 20 knots
- if an engine failure occurs during takeoff, the pitch command target speed is:
 - V_2 , if airspeed is below V_2
 - existing speed, if airspeed is between V_2 and $V_2 + 20$
 - $V_2 + 20$, if airspeed is above $V_2 + 20$
- the roll command maintains HDG SEL. Bank angle is limited to 8 degrees below 400 feet, and 10–30 degrees selectable above 400 feet AGL.

After lift-off:

- the A/T remains in THR HLD until 800 feet RA. A/T annunciation then changes from THR HLD to ARM and reduction to climb thrust can be made by pushing the N1 switch
- automatic reduction to climb thrust occurs upon reaching the selected thrust reduction altitude which is shown on the FMC CDU TAKEOFF REF page 2/2 during preflight, or when the airplane levels off in ALT HOLD or VNAV PTH. Pilot entries can be made to override the default value. Allowable entries are 800 feet to 9999 feet
- flight director engaged status is terminated by engaging an autopilot in CMD (CMD replaces FD in A/P status display)
 - pitch engages in LVL CHG and pitch mode FMA is MCP SPD unless another pitch mode has been selected
 - MCP IAS/Mach display and airspeed cursor change to $V_2 + 20$ knots
 - roll mode engages in HDG SEL unless another roll mode has been selected.

To terminate the takeoff mode below 400 feet RA, both F/D switches must be turned OFF. Above 400 feet RA, selection of another pitch mode or engaging an autopilot will terminate the takeoff mode; other F/D roll modes can be also selected.

Automatic Flight Takeoff Profile

YA371, YA372, YC201

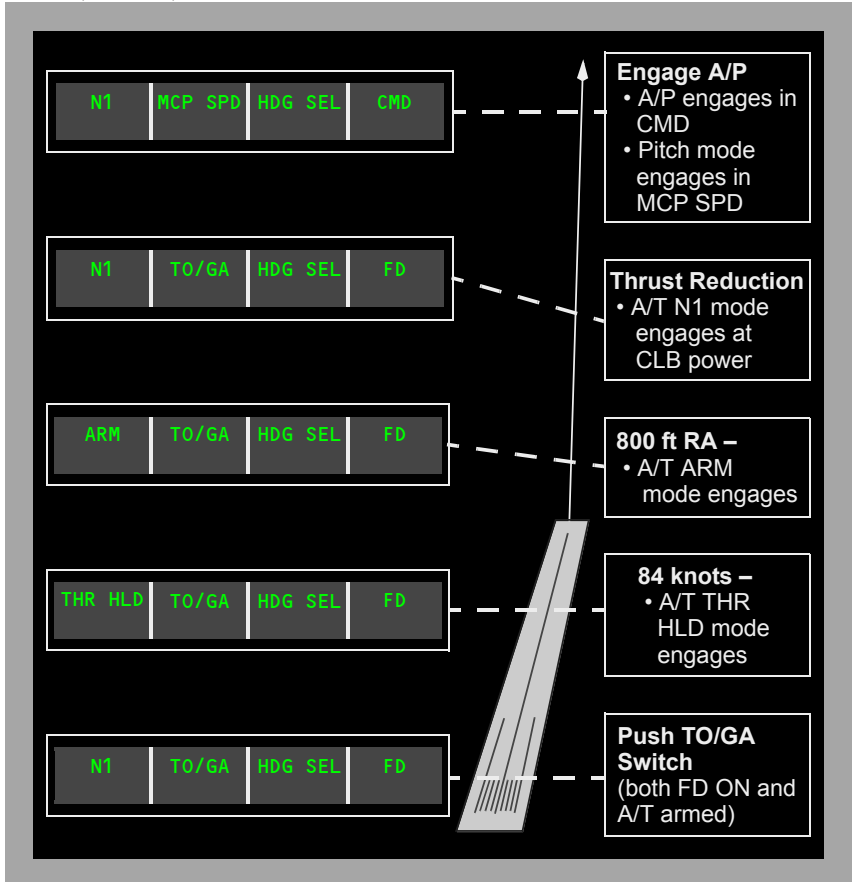

YA373 - YA377, YC202 - YE326

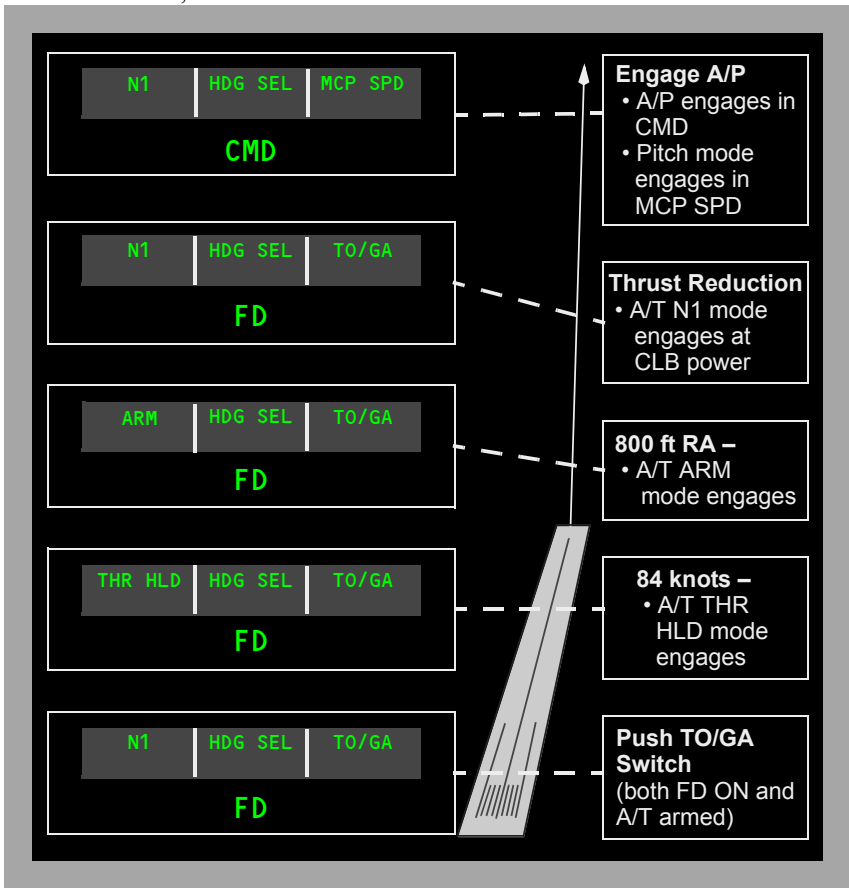

Automatic Flight En Route

The autopilot and/or the flight director can be used after takeoff to fly a lateral navigation track (LNAV) and a vertical navigation track (VNAV) provided by the FMC.

Other roll modes available are:

- VOR course (VOR/LOC)
- heading select (HDG SEL).

Other pitch modes available are:

- altitude hold (ALT HOLD)
- level change (MCP SPD)
- vertical speed (V/S).

Automatic Flight Approach and Landing

The AFDS provides guidance for single A/P non-precision approaches. The VOR/LOC switch arms the AFDS for VOR or localizer tracking. Descent may be accomplished using VNAV, LVL CHG, or V/S. VOR/LOC, LNAV, or HDG SEL may be used for the roll mode.

The AFDS provides guidance for single or dual A/P precision approaches. The approach mode arms the AFDS to capture and track the localizer and glideslope.

Approach (APP) Mode Dual A/Ps

Approach mode allows both A/Ps to be engaged at the same time. Dual A/P operation provides fail-passive operation through landing flare and touchdown or an automatic go-around. During fail passive operation, the flight controls respond to the A/P commanding the lesser control movement. If a failure occurs in one A/P, the failed channel is counteracted by the second channel such that both A/Ps disconnect with minimal airplane maneuvering and with aural and visual warnings to the pilot.

One VHF NAV receiver must be tuned to an ILS frequency before the approach mode can be selected. For a dual A/P approach, the second VHF NAV receiver must be tuned to the ILS frequency and the corresponding A/P engaged in CMD prior to 800 feet RA.

Localizer and Glideslope Armed

After setting the localizer frequency and course, pushing the APP switch selects the APP mode. The APP switch illuminates and VOR/LOC and G/S annunciate armed. The APP mode permits selecting the second A/P to engage in CMD. This arms the second A/P for automatic engagement after LOC and G/S capture and when descent below 1500 RA occurs.

The localizer can be intercepted in the HDG SEL, CWS R or LNAV mode.

Localizer Capture

YA371, YA372, YC201

The LOC capture point is variable and depends on intercept angle and rate of closure, but does not occur at less than 1/2 dot. Upon LOC capture, VOR/LOC annunciates captured, 1 CH is annunciated for A/P status, the previous roll mode disengages and the airplane turns to track the LOC.

YA373 - YA377, YC202 - YE326

The LOC capture point is variable and depends on intercept angle and rate of closure, but does not occur at less than 1/2 dot. Upon LOC capture, VOR/LOC annunciates captured, SINGLE CH is annunciated for A/P status, the previous roll mode disengages and the airplane turns to track the LOC.

Glideslope Capture

The G/S can be captured from above or below. Capture occurs at 2/5 dot and results in the following:

- G/S annunciates captured
- previous pitch mode disengages
- APP light extinguishes if localizer has also been captured
- airplane pitch tracks the G/S
- GA displayed on thrust mode display (N1 thrust limit).

After VOR/LOC and G/S are both captured, the APP mode can be exited by:

- pushing a TO/GA switch
- disengaging A/P and turning off both F/D switches
- retuning a VHF NAV receiver.

After LOC and G/S Capture

Shortly after capturing LOC or G/S and below 1500 feet RA:

- the second A/P couples with the flight controls
- test of the ILS deviation monitor system is performed and the G/S or LOC display turns amber and flashes
- FLARE armed is annunciated
YA371, YA372, YC201
- the 1 CH annunciation extinguishes
YA373 - YA377, YC202 - YE326
- the SINGLE CH annunciation extinguishes
- A/P go-around mode arms but is not annunciated.

Note: After localizer and glideslope capture during a dual autopilot approach, CWS cannot be engaged by manually overriding pitch and roll. Manual override of autopilots causes autopilot disengagement.

The A/Ps disengage and the F/D command bars retract to indicate an invalid ILS signal.

800 Feet Radio Altitude

The second A/P must be engaged in CMD by 800 feet RA to execute a dual channel A/P approach. Otherwise, CMD engagement of the second A/P is inhibited.

400 Feet Radio Altitude

The stabilizer is automatically trimmed an additional amount nose up. If the A/Ps subsequently disengage, forward control column force may be required to hold the desired pitch attitude.

If FLARE is not armed by approximately 350 feet RA, both A/Ps automatically disengage.

Flare

The A/P flare maneuver starts at approximately 50 feet RA and is completed at touchdown:

- FLARE engaged is annunciated and F/D command bars retract
- the A/T begins retarding thrust at approximately 27 feet RA so as to reach idle at touchdown. A/T FMA annunciates RETARD.
- the A/T automatically disengages approximately 2 seconds after touchdown.
- the A/P must be manually disengaged after touchdown. Landing rollout is executed manually after disengaging the A/P.

Approach (APP) Mode Single A/P

A single A/P ILS approach can be executed by engaging only one A/P in CMD after pushing the APP mode select switch. Single A/P approach operation is the same as dual, with the following exceptions:

- full automatic flare and touchdown capability is not available. FLARE is not annunciated and stabilizer trim bias is not applied
YA371, YA372, YC201
- A/P status of 1 CH is annunciated for the entire approach after localizer capture
YA373 - YA377, YC202 - YE326
- A/P status of SINGLE CH is annunciated for the entire approach after localizer capture
- an A/P go-around is not available.

Automatic Flight Approach Profile

YA371, YA372, YC201

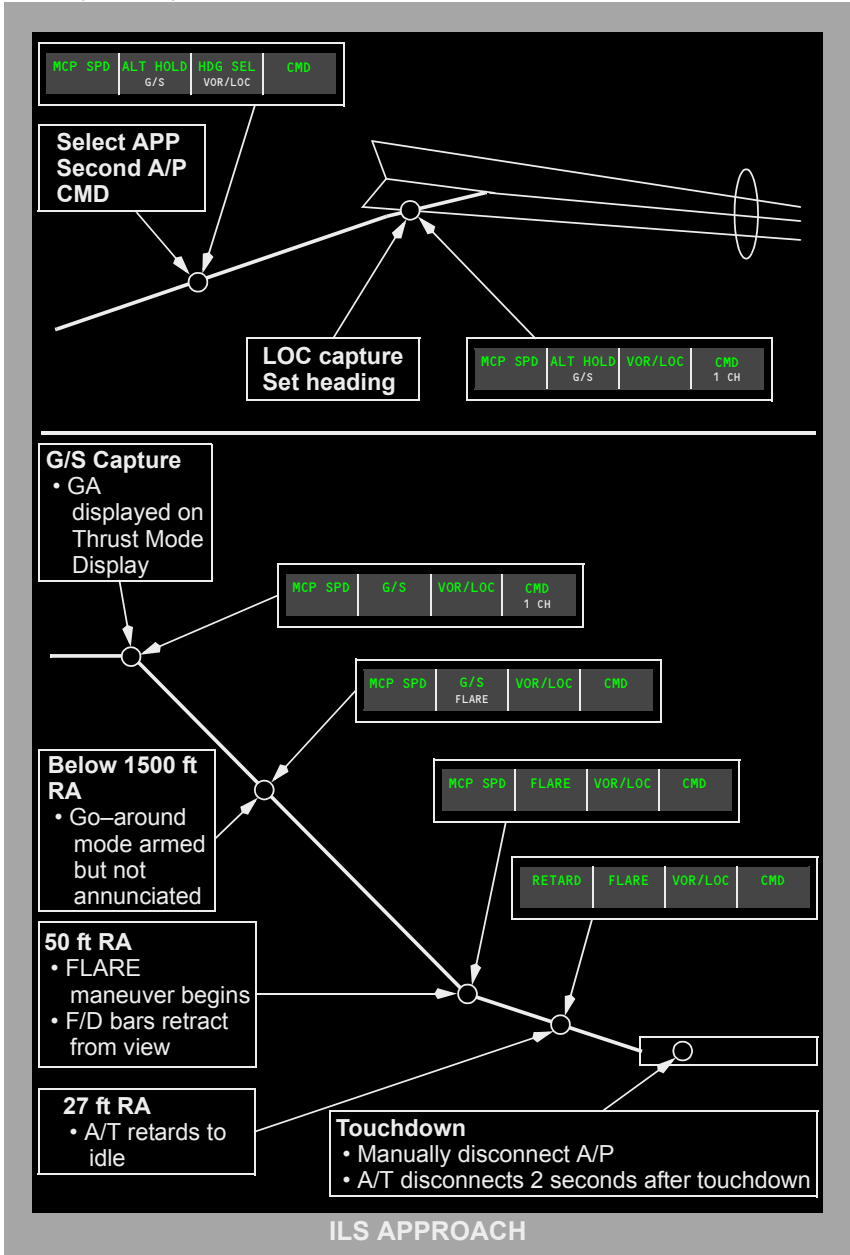

YA373 - YA377, YC202 - YE326

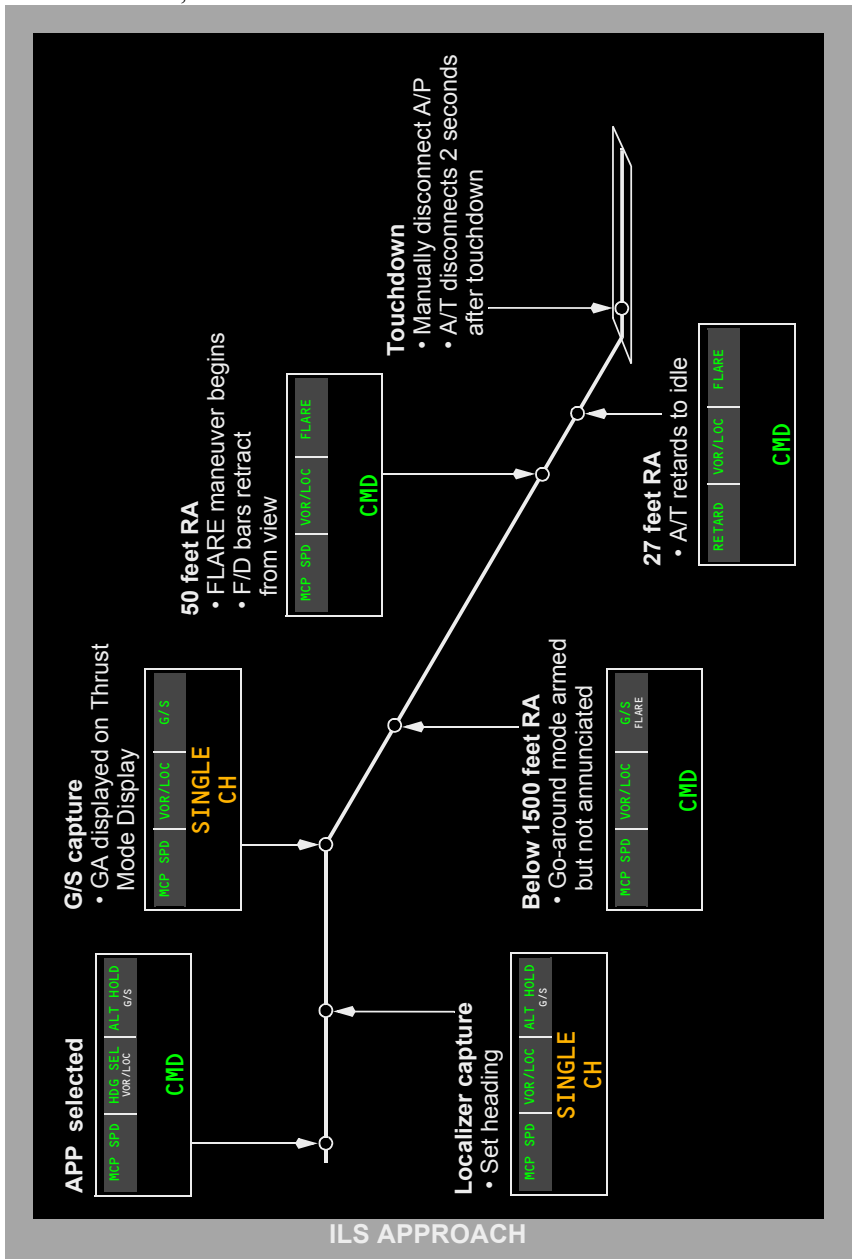

Go-Around

Go-Around (GA) mode is engaged by pushing either TO/GA switch. An A/P go-around requires dual A/P operation and is armed when FLARE armed is annunciated. If both A/Ps are not operating, a manual F/D go-around is available.

With the A/T Arm switch at ARM, the A/T go-around mode is armed:

- when descending below 2000 feet RA
- when above 2000 feet RA with flaps not up or G/S captured
- with or without the AFDS engaged.

A/P Go-Around

The A/P GA mode requires dual A/P operation and is available after FLARE armed is annunciated and prior to the A/P sensing touchdown.

With the first push of either TO/GA switch:

- A/T (if armed) engages in GA and the A/T Engaged Mode annunciation on the FMA indicates GA
- thrust advances toward the reduced go-around N1 to produce 1000 to 2000 fpm rate of climb
- pitch mode engages in TO/GA and the Pitch Engaged Mode annunciation on the FMA indicates TO/GA
- F/D pitch commands 15 degrees nose up until reaching programmed rate of climb. F/D pitch then commands target airspeed for each flap setting based on maximum takeoff weight calculations
- F/D roll commands hold current ground track. The Roll Engaged Mode annunciation on the FMA is blank
- the IAS/Mach display blanks
- the command airspeed cursor automatically moves to a target airspeed for the existing flap position based on maximum takeoff weight calculations.

Note: If the go-around mode is selected after touchdown and prior to A/T disengagement, the A/Ps disengage and the A/Ts may command GA thrust.

With the second push of either TO/GA switch after A/T reaches reduced go-around thrust:

- the A/T advances to the full go-around N1 limit.

TO/GA mode termination from A/P go-around:

- below 400 feet RA, the AFDS remains in the go-around mode unless both A/Ps and F/Ds are disengaged
- above 400 feet RA, select a different pitch or roll mode.
 - if the roll mode is changed first:
 - the selected mode engages in single A/P roll operation and is controlled by the A/P which was first in CMD
 - pitch remains in dual A/P control in TO/GA mode.

737 Flight Crew Operations Manual

- if the pitch mode is changed first:
 - the selected mode engages in single A/P pitch operation and is controlled by the A/P which was first in CMD
 - the second A/P disengages
 - the roll mode engages in CWS R.
- the A/T GA mode is terminated when:
 - another pitch mode is selected
 - ALT ACQ annunciates engaged.

Note: The pitch mode cannot be changed from TO/GA until sufficient nose-down trim has been input to allow single channel A/P operation. This nose-down trim is automatically added by the A/P to reset the trim input made by the A/P at 400 feet RA and at 50 feet RA during the approach.

With pitch mode engaged in TO/GA, ALT ACQ engages when approaching the selected altitude and ALT HOLD engages at the selected altitude if the stabilizer position is satisfactory for single A/P operation.

- if stabilizer trim position is not satisfactory for single A/P operation:
 - ALT ACQ is inhibited
 - A/P disengage lights illuminate steady red
 - pitch remains in TO/GA.

Note: To extinguish A/P disengage lights, disengage A/Ps or select higher altitude on MCP.

F/D Go-Around

If both A/Ps are not engaged, a manual F/D only go-around is available under the following conditions:

- inflight below 2000 feet RA
- inflight above 2000 feet RA with flaps not up or G/S captured
- not in takeoff mode.

With the first push of either TO/GA switch:

- A/T (if armed) engages in GA and advances thrust toward the reduced go-around N1 to produce 1000 to 2000 fpm rate of climb. The A/T Engaged Mode annunciation on the FMA indicates GA
- autopilot (if engaged) disengages
- pitch mode engages in TO/GA and the Pitch Engaged Mode annunciation on the FMA indicates TO/GA
- F/D pitch commands 15 degrees nose up until reaching programmed rate of climb. F/D pitch then commands target airspeed for each flap setting based on maximum takeoff weight calculations
- F/D roll commands approach ground track at time of engagement. The Roll Engaged Mode annunciation on the FMA is blank

- the IAS/Mach display blanks
- the command airspeed cursor automatically moves to a target airspeed for the existing flap position based on maximum takeoff weight calculations.

With the second push of either TO/GA switch (if A/T engaged and after A/T reaches reduced go-around thrust):

- the A/T advances to the full go-around N1 limit

TO/GA mode termination from F/D go-around:

- below 400 feet RA, both F/D switches must be turned off.
- above 400 feet RA, select a different pitch or roll mode.
 - if the roll mode is changed first:
 - F/D roll engages in the selected mode
 - the F/D pitch mode remains in TO/GA.
 - if the pitch mode is changed first:
 - the F/D roll mode automatically changes to HDG SEL
 - F/D pitch engages in the selected mode.
 - the A/T GA mode (if engaged) is terminated when:
 - another pitch mode is selected
 - ALT ACQ annunciates engaged.

Note: Engaging an A/P in CMD automatically engages the A/P and F/Ds in LVL CHG for pitch and HDG SEL for roll.

Single Engine F/D Go-Around

With a push of either TO/GA switch:

- F/D roll commands hold current ground track. The Roll Engaged Mode annunciation on the FMA is blank
- pitch mode engages in TO/GA and the Pitch Engaged Mode annunciation on the FMA indicates TO/GA
- the F/D target speed is displayed on IAS/Mach display
- the F/D target speed is displayed on the airspeed cursor
- F/D pitch commands 13 degrees nose up. As climb rate increases, F/D pitch commands maintain a target speed.
 - if engine failure occurs prior to go-around engagement, then F/D target speed is the selected MCP speed.
 - if engine failure occurs after go-around engagement, then F/D target speed depends on whether ten seconds have elapsed since go-around engagement:
 - if prior to ten seconds, the MCP selected approach speed becomes target speed
 - if after ten seconds and the airspeed at engine failure is within five knots of the go-around engagement speed, the airspeed that existed at go-around engagement becomes target speed

737 Flight Crew Operations Manual

- if after ten seconds and the airspeed at engine failure is more than five knots above go-around engagement speed, then the current airspeed becomes target speed.

Note: The target speed is never less than V2 speed based on flap position unless in windshear conditions.

F/D commanded acceleration cannot occur until a higher speed is selected on the MCP IAS/Mach display.

Automatic Flight Go-Around Profile

YA371, YA372, YC201

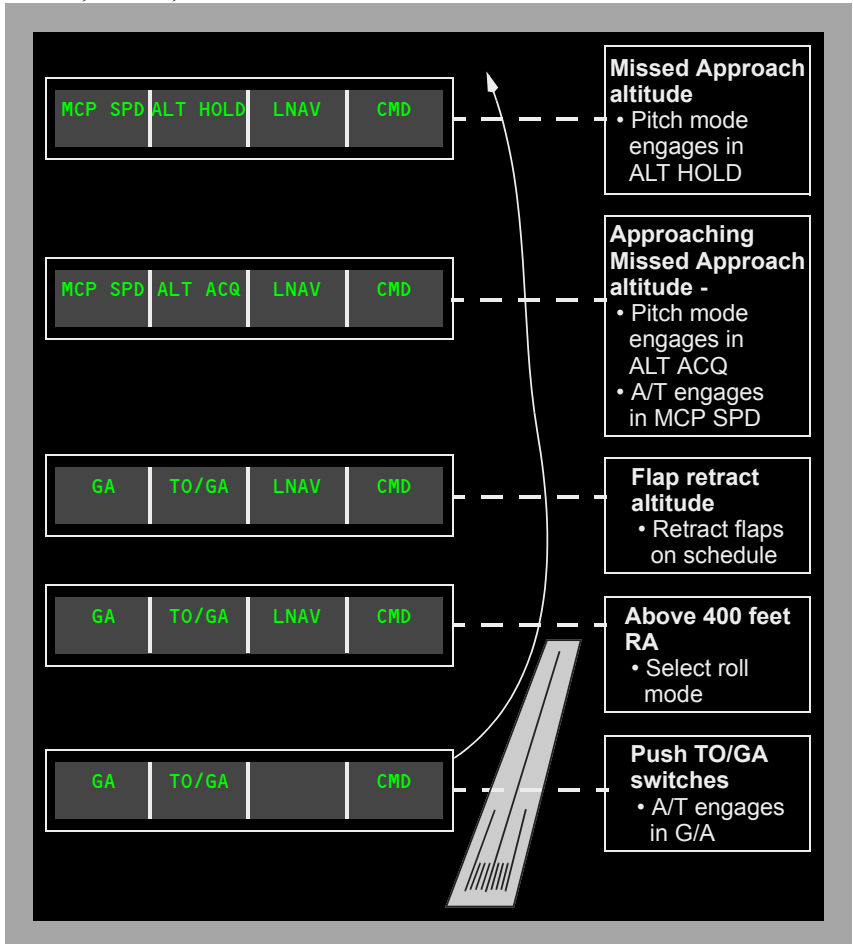

YA373 - YA377, YC202 - YE326

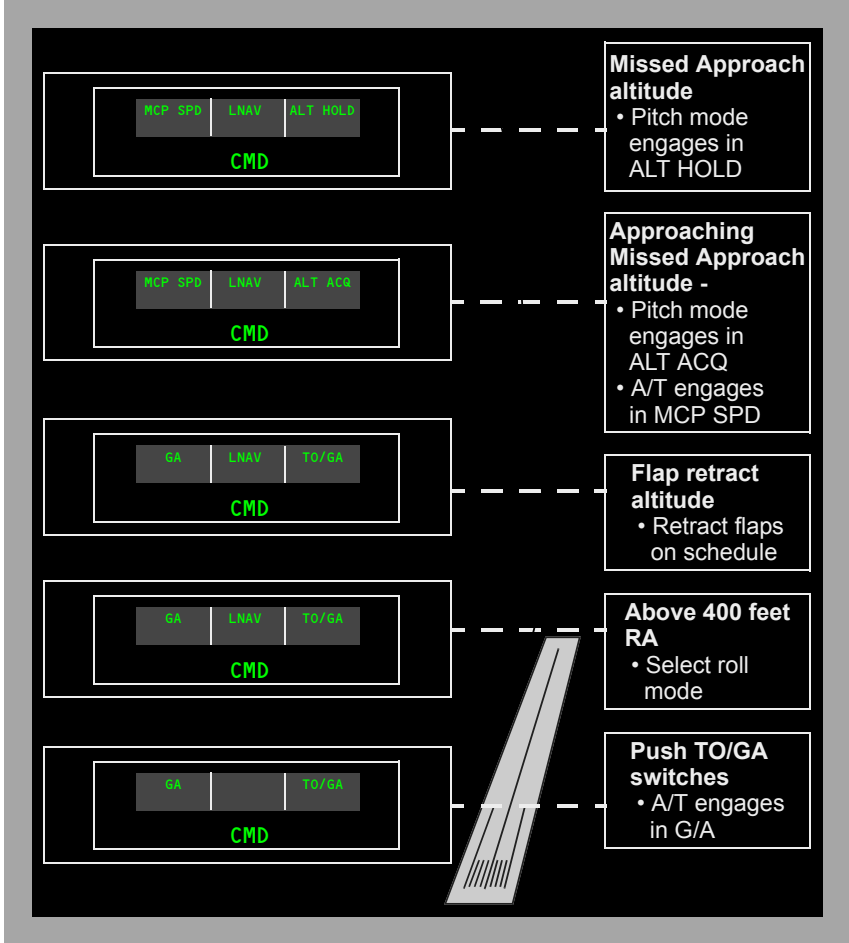

AFS Operation in Windshear

General

The autopilot and flight director provide positive corrective action to counteract most windshears. The autothrottle system also aids in windshear recovery by providing quick response to any increase or decrease in speed. The commanded levels of power may be beyond what the average pilot considers necessary but, in fact, are required by the situation.

Takeoff or Go-Around

If windshear is encountered during F/D takeoff or go-around, the F/D pitch command bar provides commands to maintain $V_2 + 20$ kts until vertical speed decreases to approximately +600 fpm. At this point, the F/D pitch bar commands a 15 degree nose-up pitch attitude. If vertical speed continues to decrease, the F/D continues to command a 15 degree pitch attitude until a speed of approximately stick shaker is reached. It then commands pitch attitudes which result in intermittent activation of the stick shaker. As the airplane transits the windshear condition, the F/D programming reverses. As climb rate increases above approximately +600 fpm, the F/D commands pitch attitudes which result in acceleration back to $V_2 + 20$ kts. The A/P and F/D both operate in a similar manner during A/P or F/D go-around.

Approach and Landing

If windshear is encountered during an ILS approach, both the F/D and A/P attempt to hold the airplane on altitude, or on glideslope after glideslope capture, without regard to angle of attack or stick shaker limitations. Airspeed could decrease below stick shaker and into a stall if the pilot does not intervene by pushing the TO/GA switch or disconnecting the A/P and flying manually.

WARNING: Although the F/D, A/P and A/T may be performing as previously described, severe windshear may exceed the performance capability of the system and/or the airplane. In this situation, the flight crew must, if necessary to avoid ground contact, be prepared to disconnect the autothrottle, advance thrust levers to the forward stop, disconnect the autopilot and manually fly the airplane.

Command Speed Limiting and Reversion Modes

AFS command limiting and reversion operation is independent of the stall warning and mach warning systems.

Command Speed Limiting

The AFS provides speed, pitch and thrust commands to avoid exceeding the following limit speeds:

- V_{mo}/M_{mo}
- wing flap placards
- landing gear placard
- minimum speed.

The commanded speed can be equal to, but does not exceed a limit speed.

Speeds greater than V_{mo}/M_{mo} cannot be selected from the MCP. Speeds can be selected which exceed flap and gear placards or are less than minimum speed.

Minimum speed is based on angle of attack and is approximately 1.3 V_s for the current flap configuration. It is sensed by the angle of attack vanes, one on either side of the forward fuselage.

If a speed greater than a placard speed, or less than minimum speed is selected, the AFS allows acceleration or deceleration to slightly short of the limit, then commands the limit speed. The overspeed or underspeed limiting symbol appears in the MCP IAS/Mach display when the commanded speed cannot be reached.

Either pitch or thrust, whichever is engaged in a speed mode, attempts to hold the limit speed. The commanded limit speed and MCP speed condition symbol, remain until another speed is selected which does not exceed the limit. A speed 15 knots greater than the minimum speed must be selected to remove the underspeed limiting symbol.

Reversion Modes

During some flight situations, speed control by the AFDS or A/T alone could be insufficient to prevent exceeding a limit speed. If this occurs, AFDS or A/T modes automatically revert to a more effective combination. The reversion modes are:

- placard limit reversion
- minimum airspeed reversion.

Mode reversion occurs slightly before reaching the limit speed. Both the AFDS and A/T have reversion modes which activate according to the condition causing the reversion.

Placard Limit Reversion

When one of the placard limit reversions (gear, flap or V_{mo}/M_{mo}) is reached, the overspeed limiting symbol appears in the MCP IAS/Mach display and the following occurs:

- if not in AFDS or A/T speed control and the A/T is armed, the A/T reverts to SPEED and controls speed to the placard limit
- if in AFDS or A/T speed control, no reversion is necessary. The AFDS or A/T, whichever is controlling speed, holds speed slightly below the placard limit
- if the A/T is not available, no reversion response to gear or flap placard speeds is available. The AFDS reverts to speed control for V_{mo}/M_{mo} speed limiting.

737 Flight Crew Operations Manual

Minimum Speed Reversion

The AFDS and A/T do not control to a speed which is less than minimum speed for the current flap configuration. This speed is approximately 1.3 Vs. Minimum speed, FMC speed, or selected speed, whichever is higher, becomes the AFS commanded speed. If actual speed becomes equal to or slightly less than the minimum speed, the underspeed limiting symbol appears in the MCP IAS/Mach Display, and if operating in the V/S mode, the AFDS reverts to LVL CHG. The AFDS will also revert to LVL CHG from VNAV PTH, except when flying a level segment.

The AFS commands a speed 5 knots greater than minimum speed. Reaching a speed 5 knots greater than minimum speed reactivates normal MCP speed selection control. The AFDS commands nose down pitch to increase airspeed if the thrust levers are not advanced. When actual speed becomes 5 knots greater than minimum speed, the underspeed limiting symbol disappears.

The A/P disengages and the F/D command bars retract when in a LVL CHG climb with a command speed equal to minimum speed and a minimum rate of climb cannot be maintained without decelerating.

Minimum speed reversion is not available when the A/T is OFF and the AFDS is in ALT HOLD or after G/S capture. Minimum speed reversion is also not available when in VNAV PTH and flying a level segment.



Intentionally
Blank



Controls and Indicators 5.10.1

- Radio Tuning Panel 5.10.1
- Audio Control Panel (ACP) 5.10.4
- SELCAL Panel 5.10.7
- ACARS Printer 5.10.8
- Miscellaneous Communication Controls (Typical) 5.10.10
- Glareshield Microphone Switch 5.10.12
- Interphone and Passenger Address Controls 5.10.13
- Cockpit Voice Recorder 5.10.14
 - Cockpit Voice Recorder Switch 5.10.15
- Call System 5.10.16

System Description 5.20.1

- Introduction 5.20.1
- Audio Systems and Audio Control Panels 5.20.1
- Speakers and Headsets 5.20.1
- Microphones 5.20.2
- Normal Audio System Operation 5.20.2
- Degraded Audio System Operation 5.20.2
- Flight Interphone System 5.20.3
- Service (Attendant) Interphone System 5.20.4
- Passenger Address System 5.20.4
- Call System 5.20.4
- VHF Communications 5.20.5
- HF Communications 5.20.5
- Selective Calling (SELCAL) 5.20.6
- Cockpit Voice Recorder 5.20.6



737 Flight Crew Operations Manual

ACARS System	5.20.6
ACARS Message	5.20.7

**Communications
Controls and Indicators**

**Chapter 5
Section 10**

Radio Tuning Panel

YA371 - YC202, YC206 - YE326

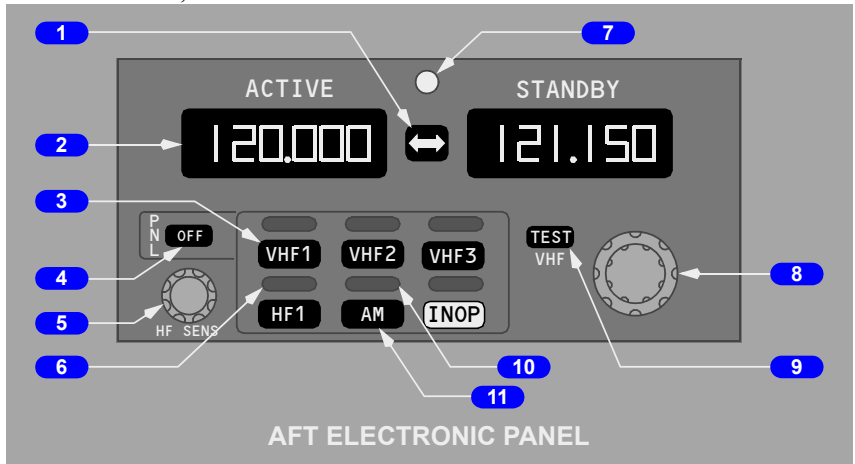

YC203

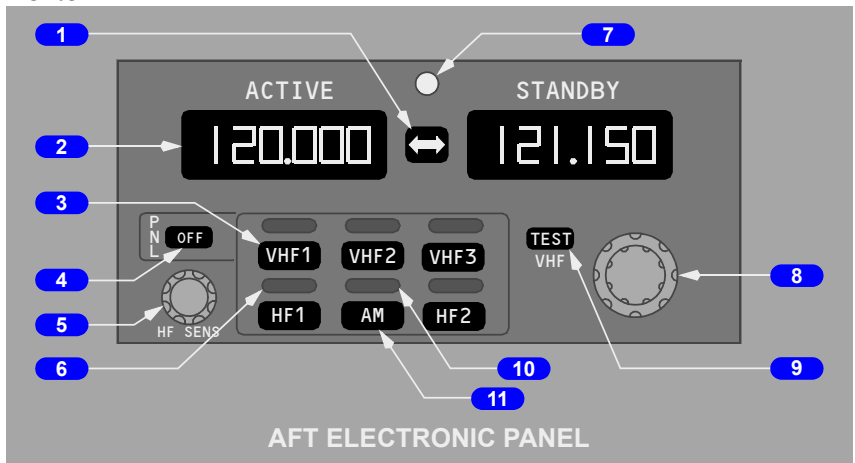

1 Frequency Transfer Switch

Push –

- transfers the STANDBY window frequency to the ACTIVE window and tunes the selected radio to the new active frequency
- transfers the ACTIVE window frequency to the STANDBY window.

2 Frequency Indicator

ACTIVE – displays the tuned frequency of the selected radio.

- displays DATA if the selected radio is in the data mode.

STANDBY – displays the preselected or previously tuned frequency of the selected radio

3 Radio Tuning Switch

Push –

- selects the VHF or HF radio to be tuned
- the tuned frequency is displayed in the ACTIVE frequency indicator
- the standby frequency is displayed in the STANDBY frequency indicator

4 Radio Tuning Panel OFF Switch

Push –

- disconnects the panel from the communication radios
- switch illuminates (white).

5 HF Sensitivity Control

Rotate – adjusts the sensitivity of the on–side HF receiver.

6 Radio Tuning Light

Illuminated (white) - indicates the selected radio.

7 Offside Tuning Light

Illuminated (white) –

- the radio normally associated with this panel is being tuned by another radio tuning panel, or
- the radio tuning panel is being used to tune a radio not normally associated with this radio tuning panel.

737 Flight Crew Operations Manual

8 Frequency Selector

Rotate - selects frequency in the STANDBY frequency indicator:

- first digit is always 1
- outer selector changes second and third digits in 1 MHz increments
- inner selector changes fourth, fifth, and sixth digits in 8.33 KHz increments.
- For airplanes with ACARS, tuning above maximum or below minimum frequency displays DATA in Frequency Indicator.

9 VHF TEST Switch

Push –

- removes automatic squelch feature, permitting reception of background noise and thereby testing receiver operation
- improves reception of weak signals.

10 AM Light

Illuminated (white) – HF AM is selected.

Extinguished – HF USB is selected.

11 AM Switch

Push – sets the AM (amplitude modulation) or USB (upper side band) mode for the selected HF.

Radio Tuning Panel Fail Modes

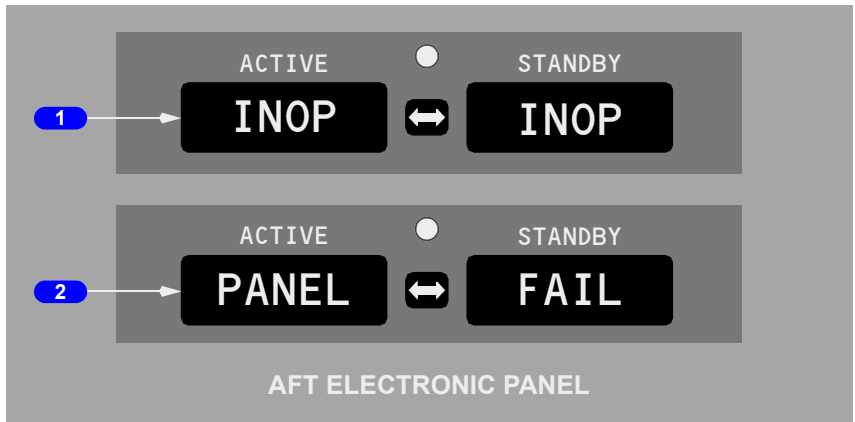

1 INOP Indication

The selected radio is not available.

2 PANEL FAIL

The radio tuning panel has failed.

Note: The selected frequencies may continue to be displayed in the frequency indicator when the radio is not available.

Audio Control Panel (ACP)

YC203



YA371 - YC202, YC206 - YE326



1 Transmitter Selector (MIC SELECTOR) Switches

Illuminated – related switch is active

Push –

- selects related communication system for subsequent transmission
- only one switch may be selected at a time; pushing a second switch deselects first switch
- reception possible over selected system regardless of whether related receiver switch is on.

2 Receiver Switches

Illuminated (white) – related switch is active

Rotate – adjusts volume

Push –

- allows reception of related communication system or navigation receiver
- multiple switches may be selected

Push again – deselects related system or receiver.

3 Push-to-Talk Switch

(spring-loaded to neutral position)

R/T (radio-transmit) – keys oxygen mask or boom microphone for transmission as selected by transmitter selector.

I/C (Intercom) – keys oxygen mask or boom microphone for direct transmission over flight interphone and bypasses transmitter selector.

4 MASK–BOOM Switch

MASK – selects oxygen mask microphone for transmissions.

BOOM – selects boom microphone for transmissions.

5 Speaker (SPKR) Switch

Illuminated (white) – SPKR switch is active.

Push – audio from selected receiver is heard on overhead speaker.

Rotate – adjusts overhead speaker volume.

Push again – deselects audio from selected receiver to be heard on overhead speaker.

6 Alternate–Normal (ALT–NORM) Switch

NORM (Normal) – ACP operates normally.

ALT (Alternate) – ACP operates in degraded mode.

7 Filter Switch

V (Voice) – receive NAV and ADF voice audio.

B (Both) – receive NAV and ADF voice and range audio.

R (Range) – receive NAV and ADF station identifier range (code) audio.

SELCAL Panel

YA371 - YC202, YC206 - YE326

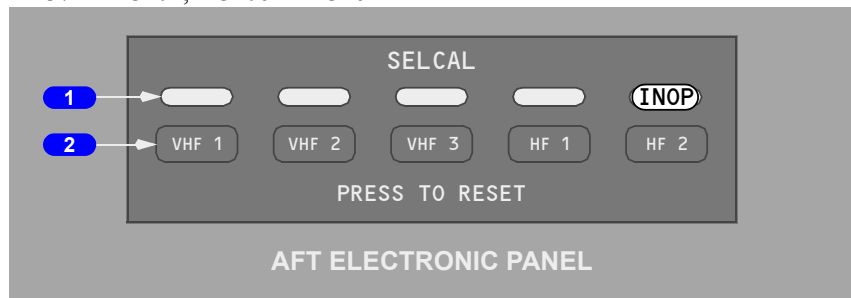

YC203

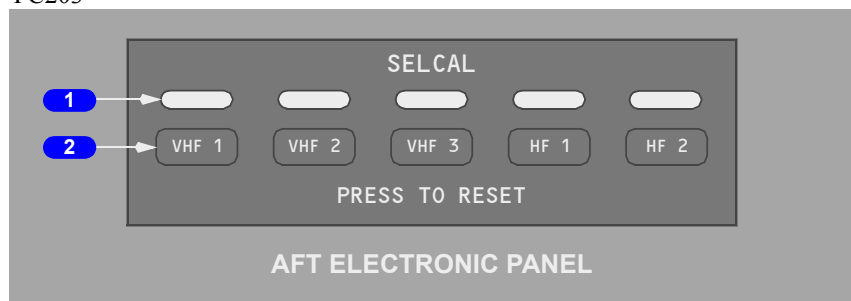

1 SELCAL Light

Illuminated (white) - alerts crew to incoming communication on indicated radio.

2 Reset Switch

Push - extinguishes and resets SELCAL light.

ACARS Printer

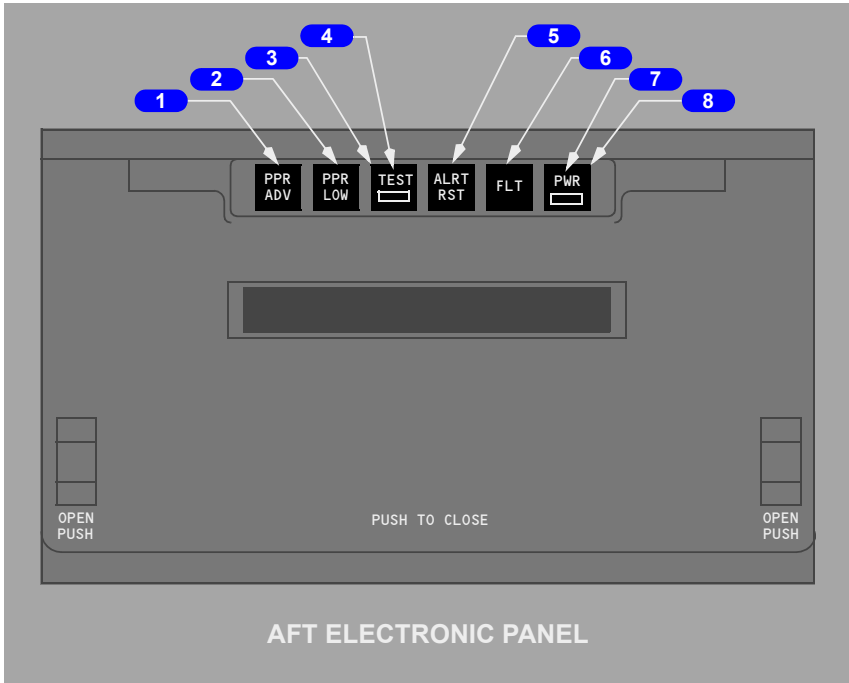

1 PAPER ADVANCE (PPR ADV) Switch

Push – advance paper while switch is held.

2 LOW PAPER (PPR) Light

Illuminated (white) - printer paper is low.

3 TEST Switch (momentary action)

Push –

- printer performs a self test
- test pattern is printed.

4 TEST Light

Illuminated (white) - a printer fault exists.

5 ALERT RESET (ALRT RST) Switch (momentary action)

Push – resets aural/visual printer alert functions.

737 Flight Crew Operations Manual

6 FAULT Light

Illuminated (white) –

- printer is out of paper or
- printer door is open or
- self-test has failed.

7 POWER (PWR) Light

Illuminated (white) - unit is powered.

8 POWER (PWR) Switch

Push - alternately removes and applies power to printer.

Miscellaneous Communication Controls (Typical)

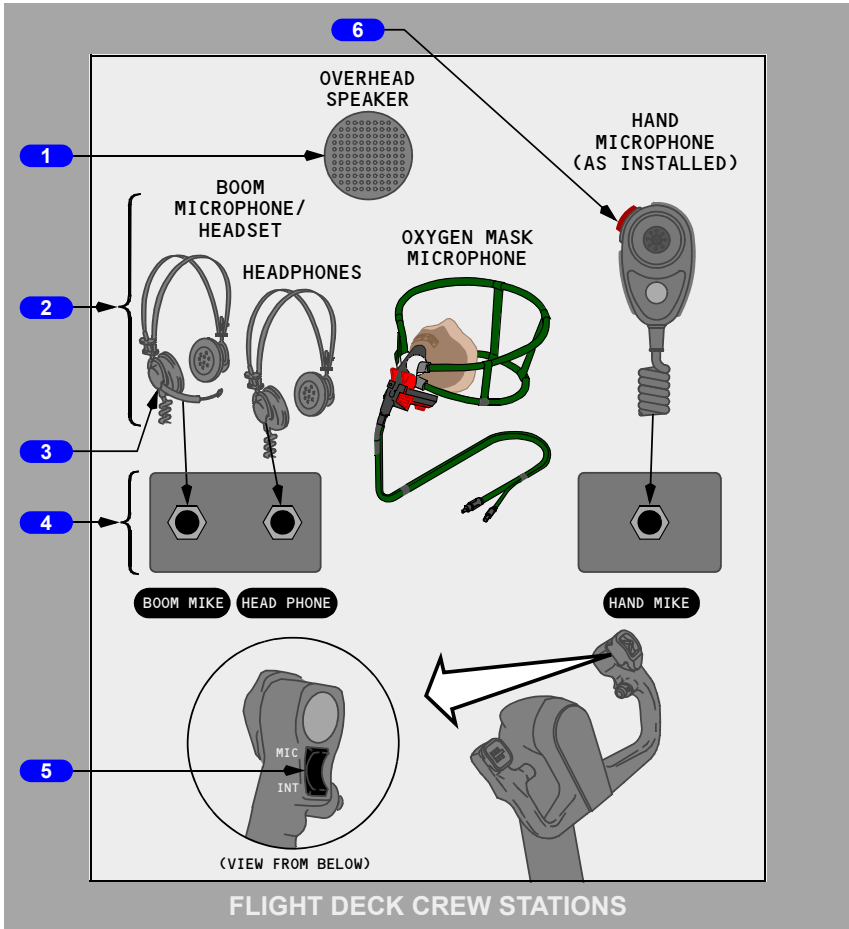

1 Overhead Speaker

Monitors audio from related pilot's ACP.

2 Headset or Headphones

Monitors audio from related ACP.

3 Standard Microphones

Choose desired microphone for voice transmission through selected radio, interphone system, or passenger address (PA).

4 Communication Jacks

Used for appropriate microphone or headphone plugs.

5 Push-To-Talk Switch

MIC (microphone) –

- selects oxygen mask or boom microphone for transmission, as selected by ACP transmitter selector.
- same as using ACP PTT switch (R/T position).

OFF – center position.

INT (interphone) –

- selects oxygen mask or boom microphone for direct transmission over flight interphone
- bypasses ACP transmitter selector
- same as using ACP PTT switch (I/C position)

6 Push-To-Talk Switch

Push – keys hand microphone for transmission, as selected by ACP transmitter selector.

Glareshield Microphone Switch

YE321 - YE326

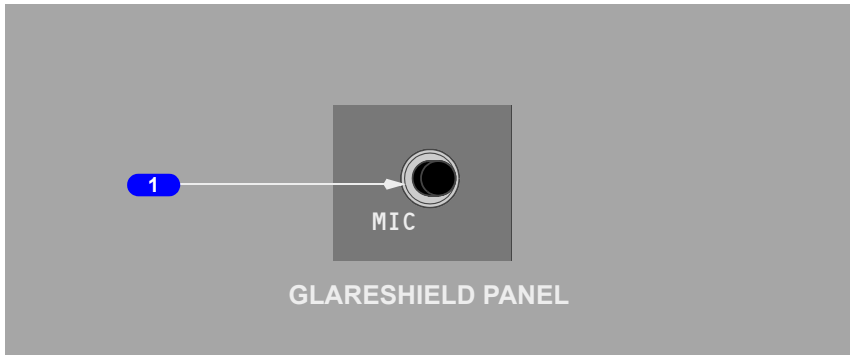

1 Glareshield MIC Switch

Push - allows oxygen mask or boom microphone transmission on the selected transmitter.

Interphone and Passenger Address Controls

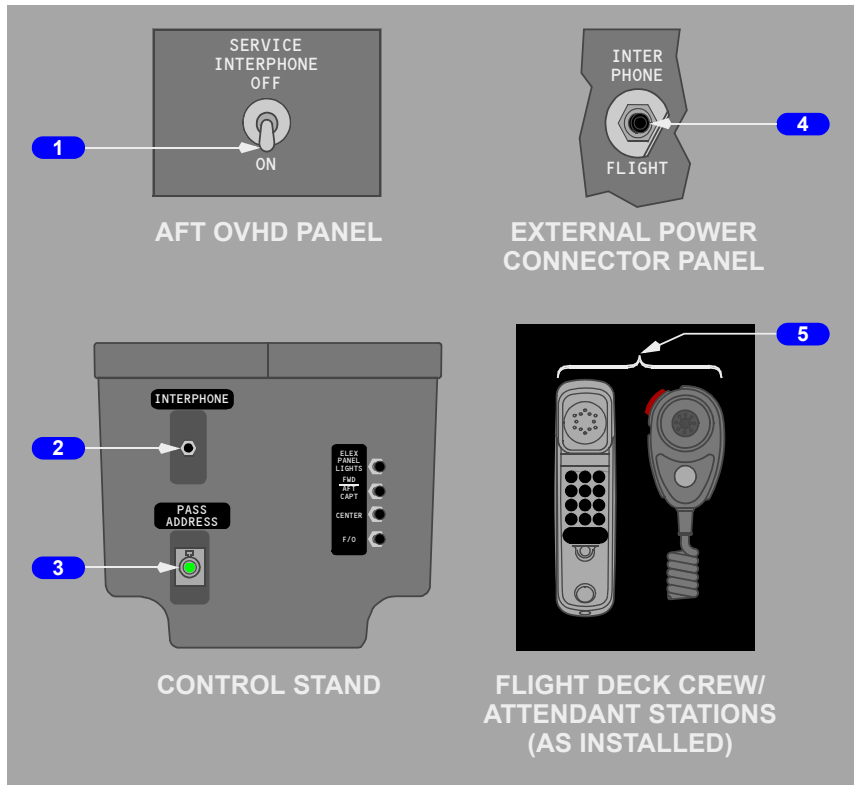

1 SERVICE INTERPHONE Switch

OFF –

- external jacks are deactivated
- communication between flight deck and flight attendants is still possible.

ON – adds external jacks to service interphone system.

2 Service INTERPHONE Handset Jack

With microphone installed, used to communicate with flight attendant stations:

- with SERVICE INTERPHONE switch ON, also used to communicate with any external jack location
- bypasses ACP.

3 Passenger Address (PASS ADDRESS) Hand Microphone Jack

With microphone installed:

- used to make PA announcements
- bypasses ACPs.

4 INTERPHONE FLIGHT Jack

Connects ground crew to flight interphone system.

5 Flight Deck / Attendant PA Hand Microphone

Used to make PA announcements.

Cockpit Voice Recorder

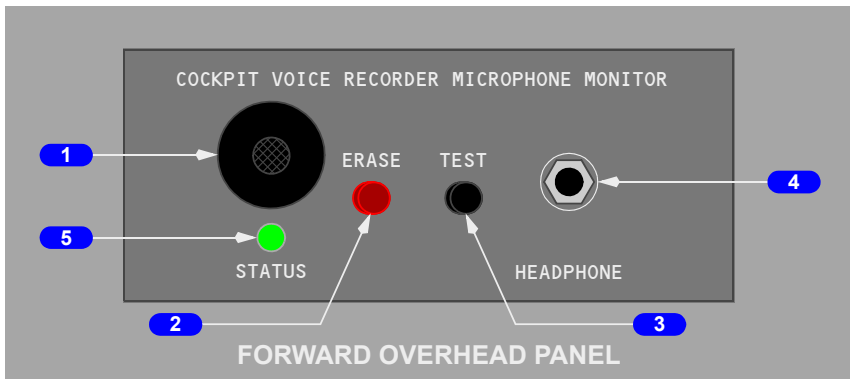

1 Area Microphone

Activated when an engine is started or the VOICE RECORDER switch is placed in the ON position.

2 ERASE Switch (red)

Push (2 seconds) –

- all four channels are erased
- operative only when airplane is on ground and parking brake is set.

3 TEST Switch

Push – after a slight delay and no faults are detected:

- status light illuminates momentarily
- a tone may be heard through a headset plugged into HEADPHONE jack.

737 Flight Crew Operations Manual

4 HEADPHONE Jack

Headphone may be plugged into jack to monitor tone transmission during test, or to monitor playback of voice audio.

5 STATUS Light

Illuminated (momentary green) – no faults are detected during recorder TEST.

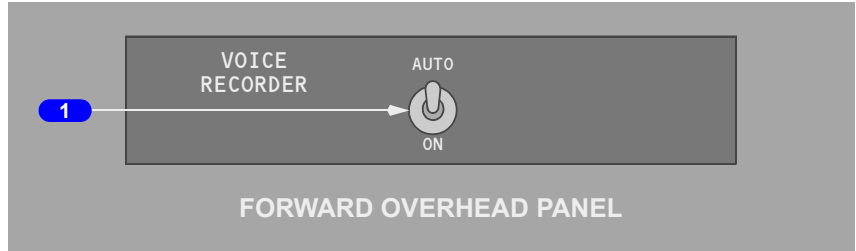
Cockpit Voice Recorder Switch**1 VOICE RECORDER Switch**

AUTO - powers the cockpit voice recorder from first engine start until 5 minutes after last engine shutdown

ON - powers the cockpit voice recorder until first engine start, then trips the switch to AUTO.

Call System

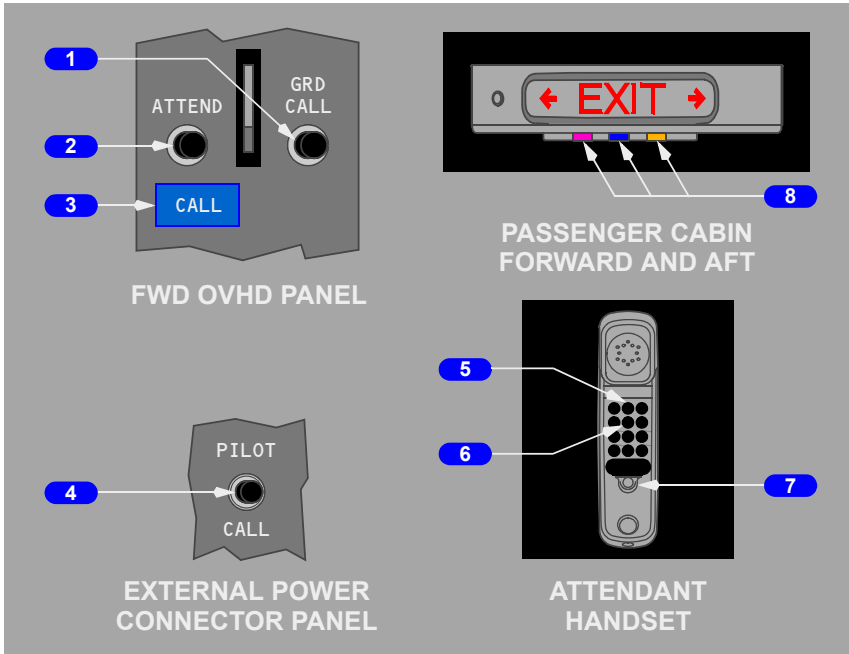

1 Ground Call (GRD CALL) Switch

Push – sounds a horn in nose wheel well until released.

2 Attendant Call (ATTEND) Switch

Push –

- sounds a two-tone chime in passenger cabin
- illuminates both pink master call lights.

3 Flight Deck CALL Light

Illuminated (blue) – flight deck is being called by flight attendants or ground crew.

4 PILOT CALL Switch

Push – sounds a single-tone chime in flight deck.

5 CAPTAIN Call Switch

Push – sounds a single-tone chime in flight deck.

6 ATTENDANT Call Switch

Push –

- sounds a two–tone chime in passenger cabin
- illuminates both pink master call lights.

7 Call RESET Switch

Push –

- extinguishes both pink master call lights
- cancels call
- disconnects the handset from the public address system.

8 Master Call Lights

Illuminated –

- amber – a lavatory call switch is activated.
- pink – flight deck or other flight attendant station is calling.
- blue – a passenger seat call switch is activated.

Intentionally
Blank



Introduction

The communication system includes:

- radio communication system
- interphone communication system
- cockpit voice recorder system
- communication crew alerting system

The communication systems are controlled using the:

- audio control panels
- radio tuning panels

Audio Systems and Audio Control Panels

An ACP is installed at the Captain, First Officer, and Observer stations. Each panel controls an independent crew station audio system and allows the crewmember to select the desired radios, navigation aids, interphones, and PA systems for monitoring and transmission.

Transmitter selectors on each ACP select one radio or system for transmission by that crewmember. Any microphone at that crew station may then be keyed to transmit on the selected system.

Receiver switches select the systems to be monitored. Any combination of systems may be selected. Receiver switches also control the volume for the headset and speaker at the related crew stations. Audio from each ACP is monitored using a headset/headphones or the related pilot's speaker.

Audio warnings for altitude alert, ground proximity warning, collision avoidance, and windshear are also heard through the speakers and headsets at preset volumes. They cannot be controlled or turned off by the crew.

Speakers and Headsets

Each crew station has a headset or headphone jack. The Captain and First Officer have speakers on the ceiling above their seats. There is no speaker at the observer station. Headset volume is controlled by the receiver switches. Speaker volume is controlled by the receiver switches and also the speaker switch.

Microphones

Hand microphones and boom microphones may be plugged into the related jacks at the flight deck crew stations. Each oxygen mask also has an integral microphone.

The MASK-BOOM switch allows selection of the oxygen mask microphone or the boom microphone. The MASK-BOOM switch does not affect the operation of the hand microphone.

Each hand microphone has a PTT switch to key the selected audio system. The PTT switches on the control wheel or ACP are used to key the oxygen mask or boom microphone, as selected by the R/T and I/C switch. The R/T and I/C switch does not affect the operation of the hand microphone.

YE321 - YE326

A MIC switch mounted on the captain's and first officer's glareshield panel is used to key the oxygen mask or boom microphone, as selected by the transmitter switch on that pilot's ACP. Pushing the glareshield MIC switch is the same as pushing the control wheel MIC switch.

Normal Audio System Operation

The Captain, First Officer, and Observer audio systems are located in a common remote electronics unit in the E/E compartment. They function independently and have separate circuit breakers. The audio systems are normally controlled by the related ACPs through digital or computerized control circuits.

Degraded Audio System Operation

If the remote electronics unit or ACP malfunctions, the ACP cannot control the remote electronics unit. Audio system operation can be switched to a degraded mode by placing the ALT-NORM switch to ALT. In this mode, the ACP at that station is inoperative and the crewmember can only communicate on one radio.

The ACP transmitter selectors are not functional. Any transmission from that station must be from the radio shown on the chart below. The transmitter selector for the usable radio illuminates when a station is operating in the degraded mode. The receiver switches are not functional, and only the usable radio is heard at a preset volume, through the headset. The speaker and speaker switch are not functional at that station. In addition, the flight interphone and service interphone cannot be used. The control wheel PTT switch INT position and the ACP PTT switch I/C position are not functional since the flight interphone is not functional.

737 Flight Crew Operations Manual

The mask and boom microphones can be used for transmission on the usable radio. The MASK–BOOM switch works normally in the degraded mode. The mask and boom microphones can be keyed with the control wheel PTT switch MIC position or the ACP PTT switch R/T position. The hand microphone is not usable in the degraded mode of operation.

Audio warnings for altitude alert, GPWS, and windshear are not heard on an audio system operating in the degraded mode.

An audio system operating in the degraded mode cannot access the passenger address system through the audio control panel. The crewmember can still use the service interphone handset and PA microphone if they are installed on the control stand.

CREW STATION AUDIO SYSTEM IN DEGRADED MODE	RADIO AVAILABLE FOR TRANSMISSION AND RECEPTION AT DEGRADED STATION
CAPTAIN	VHF-1
FIRST OFFICER	VHF-2
OBSERVER	VHF-1

Flight Interphone System

The flight interphone system is an independent communication network. Its primary purpose is to provide private communication between flight deck crewmembers without intrusion from the service interphone system. The ground crew may also use the flight interphone through a jack at the external power receptacle.

YA371 - YC207

The pilots can transmit directly over the flight interphone by using the control wheel PTT switch. Alternately, any crewmember with an ACP can transmit/receive over the flight interphone by using their related ACP and normal PTT switches. Any standard microphone may be used with the flight interphone system.

YE321 - YE326

The pilots can transmit directly over the flight interphone by using the control wheel or glareshield PTT switches. Alternately, any crewmember with an ACP can transmit/receive over the flight interphone by using their related ACP and normal PTT switches. Any standard microphone may be used with the flight interphone system.

Service (Attendant) Interphone System

The service interphone system provides intercommunication between the flight deck, Flight Attendants, and ground personnel. Flight deck crewmembers communicate using either a separate handset (if installed) or their related ACP and any standard microphone.

The Flight Attendants communicate between flight attendant stations or with the flight deck using any of the attendant handsets. Anyone who picks up a handset/microphone is automatically connected to the system.

External jacks for use by maintenance or service personnel can be added to the system by use of the service interphone switch.

Passenger Address System

The passenger address (PA) system allows flight deck crewmembers and flight attendants to make announcements to the passengers. Announcements are heard through speakers located in the cabin and in the lavatories.

The flight deck crewmembers can make announcements using a PA handset or by using any standard microphone and the related ACP. Flight Attendants make announcements using PA handset located at their stations. The attendants use the PA to play recorded music for passenger entertainment.

PA system use is prioritized. Flight deck announcements have first priority and override all others. Flight Attendant announcements override the music system.

Call System

The call system is used as a means for various crewmembers to gain the attention of other crewmembers and to indicate that interphone communication is desired. Attention is gained through the use of lights and aural signals (chimes or horn). The system can be activated from the flight deck, either flight attendant station, or from the external power receptacle. Passengers may also use the system to call an attendant, through the use of individual call switches at each seat.

The flight deck may be called from either flight attendant station or by the ground crew. The ground crew may only be called from the flight deck. Flight Attendants may be called from the flight deck, the other attendant station, or from any passenger seat or lavatory. Master call lights in the passenger cabin identify the source of incoming calls to the attendants.

Call system chime signals are audible in the passenger cabin through the PA system speakers. The PA speakers also provide an alerting chime signal whenever the NO SMOKING or FASTEN SEAT BELT signs illuminate or extinguish.

737 Flight Crew Operations Manual

Location of Call Originator	Called Position	Visual Signal at Called Position	Aural Signal at Called Position
Flight deck	Attendant station	Pink master call light	Two-tone chime
Flight deck	Nose wheel well		Horn in nose wheel well
Attendant station	Flight deck	Blue flight deck call light	Single high-tone chime
Nose wheel well	Flight deck	Blue flight deck call light	Single high-tone chime
Flight deck	Passenger cabin	NO SMOKING or FASTEN BELT signs illuminate/extinguish	Single low-tone chime

VHF Communications

Primary short-range voice communications is provided in the VHF range by three independent radios. Each radio provides for selection of an active frequency and an inactive (preselected) frequency. Voice transmission and reception are controlled at the related ACP.

The VHF/HF RTP-1 is located on the forward left side of the aft electronic panel, VHF/HF RTP-2 is on the forward right side and VHF/HF RTP-3 is on the aft portion of the panel. The VHF-2 and VHF-3 antennae are located on the lower fuselage, VHF-1 is on the upper fuselage.

Note: VHF antennae located on the lower fuselage are susceptible to multipath interference from nearby structures or vehicles. This may disrupt VHF communications. VHF antennae located on the upper fuselage are not as susceptible to this interference.

HF Communications

YA371 - YC202, YC206 - YE326

The HF communication radio can be tuned by any radio tuning panel. HF radio sensitivity can only be set on the on-side radio tuning panel.

YC203

There are two independent HF communication radios, designated HF 1 and HF 2. Each HF radio can be tuned by any radio tuning panel. HF radio sensitivity can only be set on the on-side radio tuning panel.

The audio control panels are used to control voice transmission and receiver monitoring. When an HF transmitter is keyed after a frequency change, the antenna tunes. A steady or intermittent tone may be heard through the audio system. While tuning, the tone can last as long as 7 seconds. If the system fails to tune, the tone will last more than 7 seconds, to a maximum of 15 seconds. The antenna is located in the vertical stabilizer.

YC203

Both HF radios use a common antenna. When either HF radio is transmitting, the antenna is disconnected from the other HF radio, and it cannot be used to transmit or receive. However, both HF radios can receive simultaneously if neither is being used for transmitting.

Selective Calling (SELCAL)

A ground station desiring communications with the flight deck can use the SELCAL system. SELCAL monitors selected frequencies on VHF and HF radios. Each airplane is assigned a unique four-letter SELCAL code. When the system receives an incoming call from a ground station, a two-tone chime sounds and the respective SELCAL light illuminates.

Cockpit Voice Recorder

The cockpit voice recorder uses four independent channels to record flight deck audio for 120 minutes. Recordings older than 120 minutes are automatically erased. One channel records flight deck area conversations using the area microphone. The other channels record individual ACP output (headset) audio and transmissions for the pilots and observer.

ACARS System

The ARINC Communications Addressing and Reporting System (ACARS) is an addressable digital data link system which permits exchange of data and messages between an airplane and a ground-based operation center utilizing an onboard VHF communications system.

The ACARS airborne subsystem provides for the manual entry of routine data such as departure/arrival information. Also possible is manual entry of addresses (telephone codes) of parties on the ground for voice communications.

The airborne system consists of a management unit in the E/E compartment, either a interactive display unit or multipurpose control display unit (MCDU), and frequently a printer. Data is entered and transmitted to the ground operations center.

ACARS Message

YA377, YC207

The •ACARS messages are displayed below the Crew Alerts on the Upper Display Unit. The •ACARS message can be either a medium level message or a low level message. A medium level •ACARS message is accompanied by a Hi/Lo chime over the flight deck loudspeaker. A low level •ACARS message is not accompanied by a chime and its position on the Upper Display Unit is indented one space to the right of higher level messages.

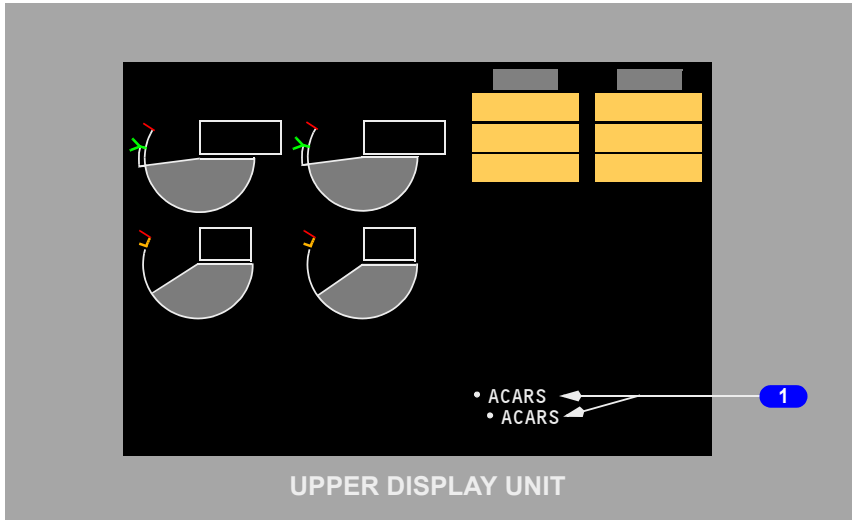

1 •ACARS Message (white)

Indicates receipt of an ACARS message.

The •ACARS message will continue to be displayed as long as any pending ACARS messages remain in the queue.



Intentionally
Blank



Controls and Indicators **6.10.1**

- Electrical Panel 6.10.1
- AC and DC Metering Panel 6.10.2
- Generator Drive and Standby Power Panel 6.10.5
- Ground Power Panel and Bus Switching Panel 6.10.7
- Ground Service Switch 6.10.9

System Description **6.20.1**

- Introduction 6.20.1
- Electrical Power Generation 6.20.1
 - Engine Generators 6.20.1
 - APU Generator 6.20.1
 - External Ground Power 6.20.1
 - Ground Service 6.20.2
 - Electrical Power Schematic 6.20.2
- AC Power System 6.20.3
 - Bus Tie System 6.20.3
 - Automatic Load Shedding (Engine Generators) 6.20.4
 - APU Automatic Load Shedding 6.20.4
 - AC Power Schematic 6.20.5
- Electrical Power Controls and Monitoring 6.20.6
 - Generator Drive 6.20.6
 - AC Voltmeter, Ammeter and Frequency Meter 6.20.6
 - DC Voltmeter and Ammeter 6.20.6
 - Electrical Power Controls and Monitoring Schematic 6.20.7
- DC Power System 6.20.8
 - Transformer Rectifier Units 6.20.8
 - Battery Power 6.20.8
 - Battery Charger Transformer/Rectifier 6.20.9
 - DC Power System Schematic 6.20.10



737 Flight Crew Operations Manual

Standby Power System	6.20.11
Normal Operation	6.20.11
Alternate Operation	6.20.11
Static Inverter	6.20.12
Standby Power System Schematic	6.20.13
All Generators Inoperative	6.20.14
Basic Equipment Operating – Captain Instrument Panel	6.20.16
Basic Equipment Operating – First Officer Instrument Panel	6.20.18

**Electrical
Controls and Indicators**

**Chapter 6
Section 10**

Electrical Panel

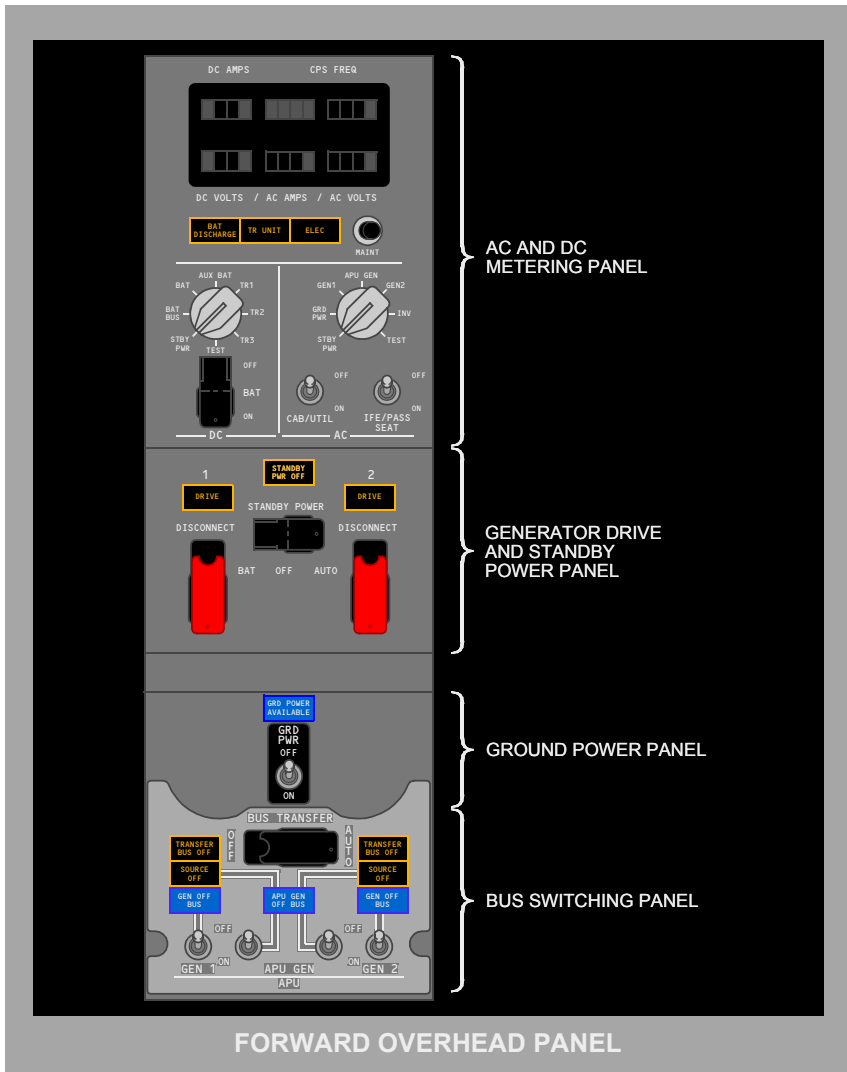

AC and DC Metering Panel

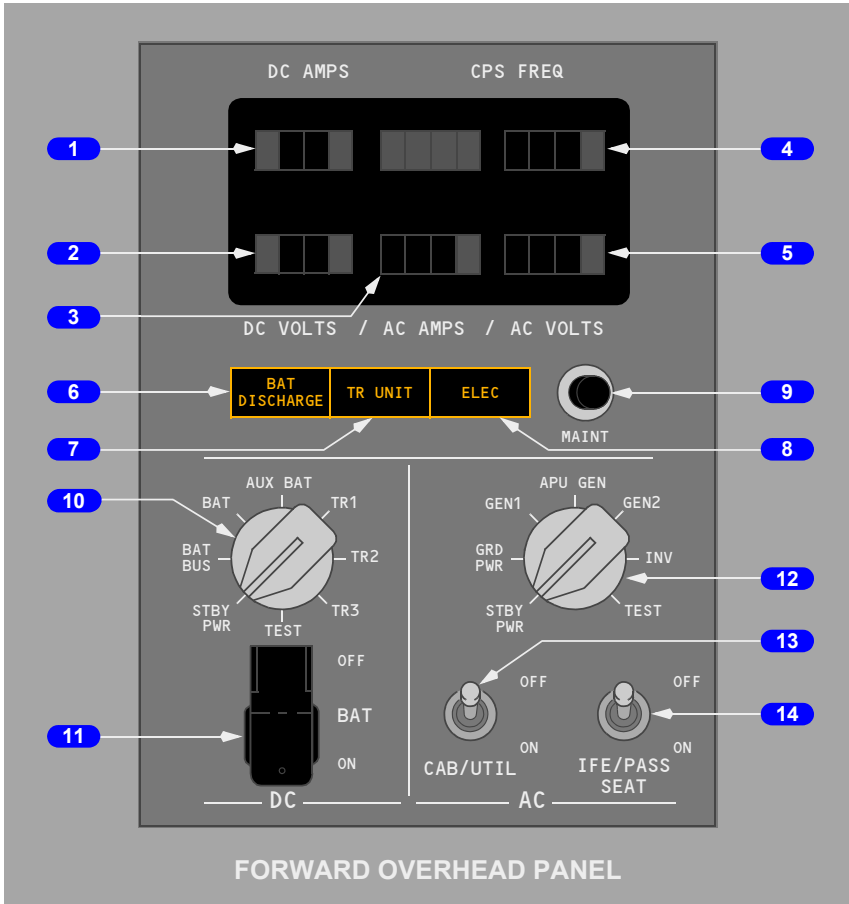

1 DC Ammeter

Indicates amperage of source selected by DC meters selector.

2 DC Voltmeter

Indicates voltage of source selected by DC meters selector.

3 AC Ammeter

Indicates amperage of source selected by AC meters selector.

737 Flight Crew Operations Manual

4 Frequency Meter

Indicates frequency of source selected by AC meters selector.

5 AC Voltmeter

Indicates voltage of source selected by AC meters selector.

6 Battery Discharge (BAT DISCHARGE) Light

Illuminated (amber) – with BAT switch ON, excessive battery discharge detected.

7 TR UNIT Light

Illuminated (amber) –

- on the ground – any TR has failed.
- in flight –
 - TR1 failed; or
 - TR2 and TR3 failed.

8 Electrical (ELEC) Light

Illuminated (amber) – a fault exists in DC power system or standby power system.

Note: Operates only with airplane on ground.

9 Maintenance Test (MAINT) Switch

Used by maintenance.

10 DC Meters Selector

Selects DC source for DC voltmeter and DC ammeter indications.

TEST – used by maintenance.

11 Battery (BAT) Switch

OFF –

- removes power from battery bus and switched hot battery bus when operating with normal power sources available
- removes power from battery bus, switched hot battery bus, DC standby bus, static inverter, and AC standby bus when battery is only power source.

ON (guarded position) –

- provides power to switched hot battery bus
- energizes relays to provide automatic switching of standby electrical system to battery power with loss of normal power.

12 AC Meters Selector

Selects AC source for AC voltmeter, AC ammeter and frequency meter indications

TEST – used by maintenance.

13 CAB/UTIL Switch

OFF – removes electrical power from galley and cabin equipment systems including:

- all 115V AC galley busses
YA371 - YA377, YE321 - YE326
- cabin recirculation fan
YC201 - YC207
- left & right recirculation fans
- fwd and aft door area heaters
- drain mast heaters
- lavatory water heaters
- logo lights
- potable water compressor
- 115V AC shaver outlets when installed

ON – supplies electrical power to galley and cabin equipment systems.

14 IFE/PASS SEAT Switch

OFF – removes electrical power from installed components of the passenger seats and in-flight entertainment systems including:

- 115V AC audio entertainment equipment
- 115V AC video entertainment equipment
- cabin telephone equipment
- FAX machine
- 28V DC video equipment and passenger seat electronic outlets
YA371 - YA376, YC201 - YC206, YE321 - YE326
- ACARS printer

ON – supplies electrical power to installed components of the passenger seats and in-flight entertainment systems.

Generator Drive and Standby Power Panel

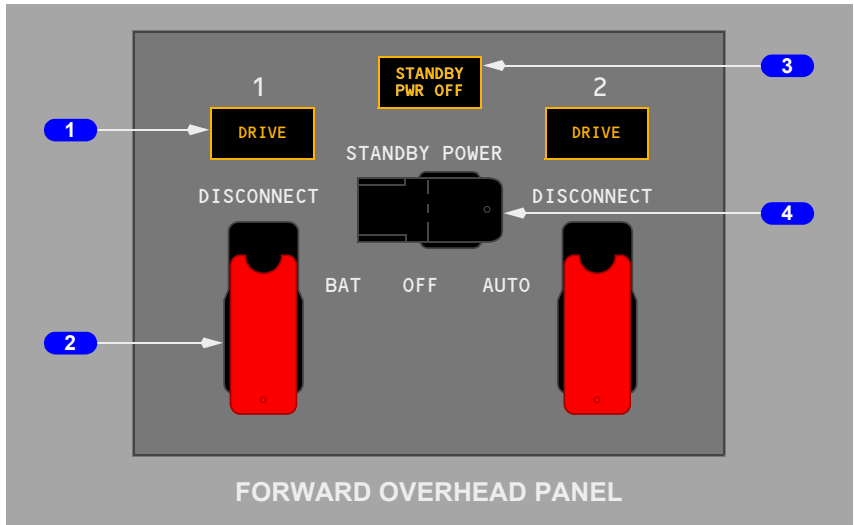

1 Generator Drive (DRIVE) Lights

Illuminated (amber) – Integrated drive generator (IDG) low oil pressure caused by one of the following:

- IDG failure
- engine shutdown
- IDG automatic disconnect due to high oil temperature
- IDG disconnected through generator drive DISCONNECT switch.

2 Generator Drive Disconnect (DISCONNECT) Switches (guarded)

Disconnects IDG if electrical power is available and engine start lever is in IDLE. IDG cannot be reconnected in the air.

3 STANDBY Power Off (PWR OFF) Light

Illuminated (amber) – one or more of the following busses are unpowered:

- AC standby bus
- DC standby bus
- battery bus.

4 STANDBY POWER Switch

AUTO (guarded position) –

- In flight, or on the ground, and AC transfer busses powered:
 - AC standby bus is powered by AC transfer bus 1
 - DC standby bus is powered by TR1, TR2 and TR3
- In flight, or on the ground, loss of all AC power
 - AC standby bus is powered by battery through static inverter
 - DC standby bus is powered by battery
 - Battery bus is powered by battery.

OFF (center position) –

- STANDBY PWR OFF light illuminates
- AC standby bus, static inverter, and DC standby bus are not powered.

BAT (unguarded position) –

- AC standby bus is powered by battery through static inverter
- DC standby bus and battery bus are powered directly by battery.

Ground Power Panel and Bus Switching Panel

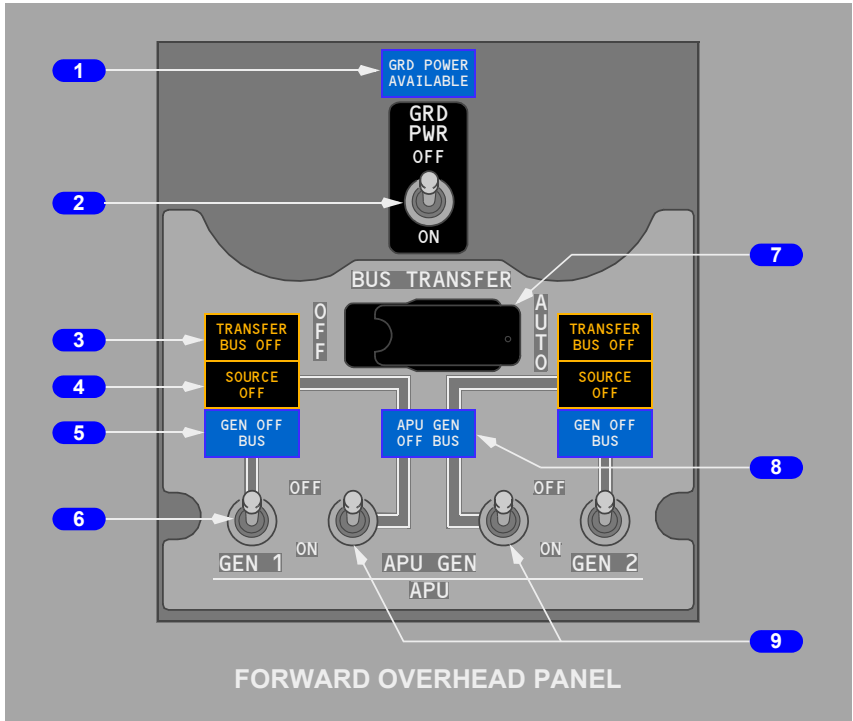

1 Ground Power Available (GRD POWER AVAILABLE) Light

Illuminated (blue) – ground power is connected and meets airplane power quality standards.

2 Ground Power (GRD PWR) Switch

Three position switch, spring-loaded to neutral

OFF – disconnects ground power from AC transfer busses.

ON – if momentarily moved to ON position and ground power is available:

- removes previously connected power from AC transfer busses
- connects ground power to AC transfer busses if power quality is correct.

3 TRANSFER BUS OFF Lights

Illuminated (amber) – related transfer bus is not powered.

4 SOURCE OFF Lights

Illuminated (amber) – no source has been manually selected to power the related transfer bus, or the manually selected source has been disconnected

- if a source has been selected to power the opposite transfer bus, both transfer busses are powered.

5 Generator Off Bus (GEN OFF BUS) Lights

Illuminated (blue) – IDG is not supplying power to the related transfer bus.

6 Generator (GEN) Switches

Three position switch, spring-loaded to neutral.

OFF – disconnects IDG from related AC transfer bus by opening generator circuit breaker.

ON – connects IDG to related AC transfer bus by disconnecting previous power source and closing generator circuit breaker,

7 BUS TRANSFER Switch

AUTO (guarded position) – BTBs operate automatically to maintain power to AC transfer busses from any operating generator or external power

- DC cross tie relay automatically provides normal or isolated operation as required.

OFF – isolates AC transfer bus 1 from AC transfer bus 2 if one IDG is supplying power to both AC transfer busses

- DC cross tie relay opens to isolate DC bus 1 from DC bus 2.

8 APU Generator Off Bus (GEN OFF BUS) Light

Illuminated (blue) – APU is running and not powering a bus.

9 APU Generator (GEN) Switches

Three position switch, spring-loaded to neutral.

OFF –

- APU generator powering both AC transfer busses
 - moving a single APU GEN switch to OFF illuminates related SOURCE OFF light. APU continues to power AC transfer busses
 - subsequently moving other APU GEN switch to OFF disconnects APU generator from tie bus and removes APU power from AC transfer busses
- APU generator powering one AC transfer bus; IDG powering one AC transfer bus

737 Flight Crew Operations Manual

- moving related APU GEN switch to OFF disconnects APU generator from tie bus and AC transfer bus. IDG powers AC transfer busses.

ON –

- Neither AC transfer bus powered by IDG – moving a single APU GEN switch to ON:
 - connects both AC transfer busses to the APU generator
 - disconnects external power, if connected
 - opposite SOURCE OFF light illuminates until the other APU GEN switch is moved to ON.
- Both AC transfer busses powered by IDGs – moving an APU GEN switch ON:
 - powers the related AC transfer bus from the APU generator
 - other AC transfer bus continues to receive power from the IDG.

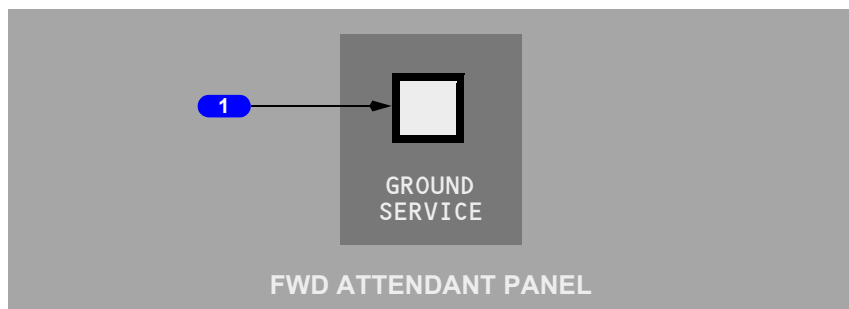
Ground Service Switch

1 GROUND SERVICE Switch

Momentary push-button switch.

Provides manual control of ground service busses. Enables servicing airplane using external power without activating AC transfer busses.

Illuminated (white) –

- ON – connects external power to ground service busses
- OFF – disconnects external power from ground service busses.

Intentionally
Blank

Introduction

Dual Battery

Primary electrical power is provided by two engine integrated drive generators (IDGs) which supply three-phase, 115 volt, 400 cycle alternating current. Each IDG supplies its own bus system in normal operation and can also supply essential and non-essential loads of the opposite side bus system when one IDG is inoperative. Transformer rectifier (TR) units and the main battery/battery charger supply DC power. The main and auxiliary batteries also provide backup power for the AC and DC standby system. The APU operates a generator and can supply power to both AC transfer busses on the ground or in flight.

There are two basic principles of operation for the 737 electrical system:

- There is no paralleling of the AC sources of power.
- The source of power being connected to a transfer bus automatically disconnects an existing source.

The electrical power system may be categorized into three main divisions: the AC power system, the DC power system, and the standby power system.

Electrical Power Generation

Engine Generators

Primary power is obtained from two engine IDGs. The IDG maintains a constant generator speed throughout the normal operating range of the engine. An integral electro-mechanical disconnect device provides for complete mechanical isolation of the IDG.

APU Generator

The APU generator can supply power to both AC transfer busses on the ground or in flight. As the only power source, the APU generator can meet electrical power requirements for all ground conditions and most flight conditions.

External Ground Power

An external AC power receptacle located near the nose gear wheel well, on the lower right side of the fuselage, allows the use of an external power source. Status lights on a panel adjacent to the receptacle permit the ground crew to determine if external power is being used. When connected, external power can supply power to both transfer busses.

Ground Service

For ground servicing, a ground service switch is on the forward attendant's panel. The switch provides ground power directly to the AC ground service busses for utility outlets, cabin lighting and the battery charger without powering all airplane electrical busses. The ground service switch is a momentary push button and is overridden when both AC transfer busses are powered.

Electrical Power Schematic

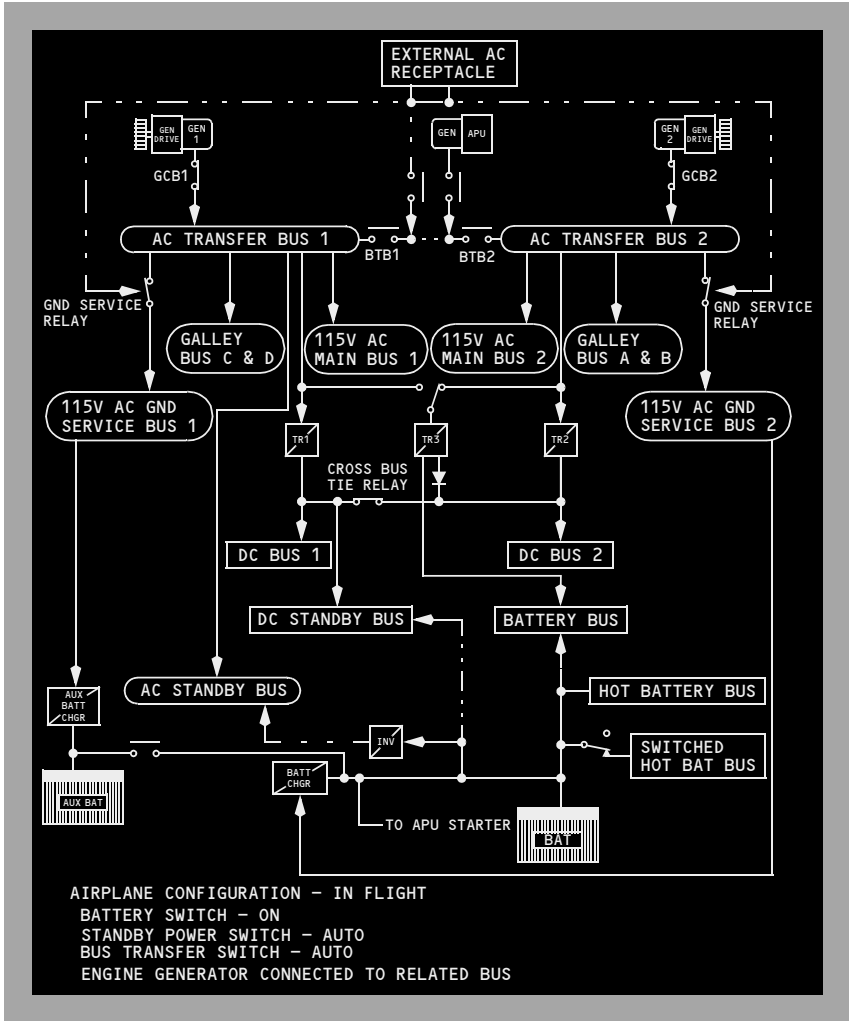

AC Power System

Each AC power system consists of a transfer bus, a main bus, two galley busses, and a ground service bus. Transfer bus 1 also supplies power to the AC standby bus. If the AC source powering either transfer bus fails or is disconnected, the transfer bus can be powered by any available source through the tie bus with the bus tie breakers (BTBs).

With the airplane on the ground and both generator control switches OFF, or with both engines shut down, selecting the GRD PWR switch ON connects external power to both transfer busses. Likewise, selecting either APU GEN switch ON connects APU power to both transfer busses. Whichever source is selected last powers both busses. It is not possible to power one transfer bus with external power and one transfer bus with APU power.

The transfer busses can be powered from the engine generators by momentarily positioning the related generator switch to ON. This closes the related generator circuit breaker (GCB) and connects the generator to the transfer bus. Whenever external power or APU is powering both transfer busses, and engine generator power is applied to its onside transfer bus, external power or APU continues to supply power to the remaining transfer bus.

In flight, each engine generator normally powers its own transfer bus. If an engine generator is no longer supplying power, the BTBs automatically close to allow the other engine generator to supply both transfer busses through the tie bus and BTBs. The APU can power either or both busses through the BTBs.

The system also incorporates an automatic generator on-line feature in case the airplane takes off with the APU powering both transfer busses. If the APU is either shut down or fails, the engine generators are automatically connected to their related transfer busses. This action occurs only once in flight and only under the circumstances described above.

Bus Tie System

Either generator or the APU can supply power to both transfer busses. If the BUS TRANS switch is in the AUTO position and the source powering the transfer bus is disconnected or fails, the source powering the opposite transfer bus automatically picks up the unpowered transfer bus through the BTBs.

Automatic Load Shedding (Engine Generators)

For single generator operation, the system is designed to shed electrical load incrementally based on actual load sensing. The galleys and main bus on transfer bus 2 are shed first; if an overload is still sensed, the galleys and main bus on transfer bus 1 are shed; if overload still exists, the IFE buses are shed. When configuration changes to more source capacity (two generator operation), automatic load restoration of the main busses, galley busses and IFE buses occurs; manual restoration of galley and main bus power can be attempted by moving the CAB/UTIL Power Switch to OFF, then back ON.

APU Automatic Load Shedding

In flight, if the APU is the only source of electrical power, all galley busses and main busses are automatically shed. If electrical load still exceeds design limits, both IFE busses are also automatically shed. On the ground, the APU attempts to carry a full electrical load. If an overload condition is sensed, the APU sheds galley busses and main busses until the load is within limits. Manual restoration of galley and main bus power can be attempted by moving the CAB/UTIL Power Switch to OFF, then back ON.

AC Power Schematic

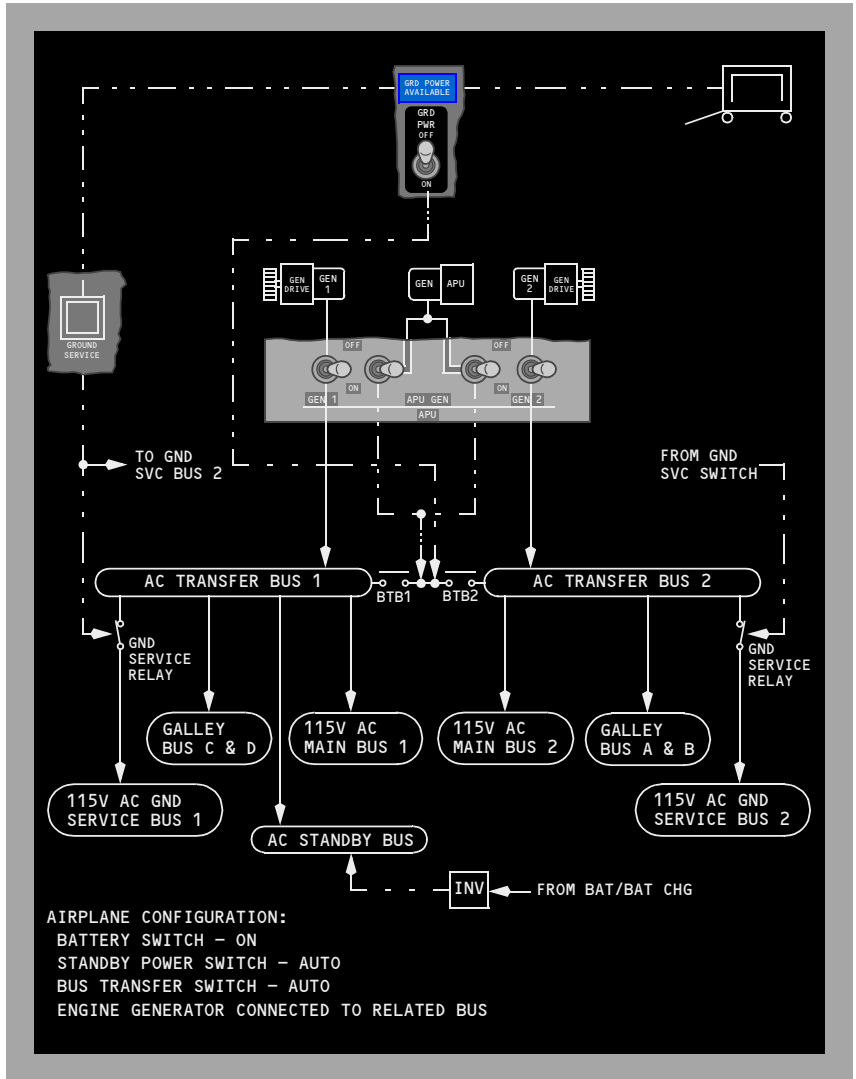

Electrical Power Controls and Monitoring

Generator Drive

The IDGs contain the generator and drive in a common housing, and are lubricated and cooled by a self-contained oil system. An integral electro-mechanical disconnect device provides for complete mechanical isolation of the IDG.

The generator drive (DRIVE) amber caution light is illuminated when low oil is sensed in the IDG. IDG low oil pressure is caused by one of the following:

- IDG failure
- engine shutdown
- IDG automatic disconnect due to high oil temperature
- IDG disconnected through generator drive DISCONNECT switch.

A generator drive disconnect switch is installed. This switch disconnects the generator from the engine in the event of a generator drive malfunction. Reactivation of the generator may be accomplished only on the ground by maintenance personnel.

AC Voltmeter, Ammeter and Frequency Meter

AC voltage and frequency may be read on the AC voltmeter and frequency meter for standby power, ground power, generator No. 1, APU generator, generator No. 2 and the static inverter. Frequency is indicated only when the generator is electrically excited. The voltage regulator automatically controls the generator output voltage.

Current readings for the two engine IDGs and the APU generator may be read on the AC ammeter.

The TEST position is used by maintenance and connects the voltage and frequency meter to the power systems test module for selection of additional reading points.

Normal indications are:

- AC voltmeter – 115 +/- 5volts
- Frequency meter – 400 CPS +/- 10 CPS.

Note: Normal AC voltmeter indication for the APU generator with the AC busses loaded: 110 - 125 volts.

DC Voltmeter and Ammeter

DC voltage and amperage may be read on the DC voltmeter and ammeter for the battery and each of the three TRs. The standby power and battery bus displays only DC voltage.

737 Flight Crew Operations Manual

Normal indication is 26 +/- 4 volts. During primary charge cycle operation battery voltage can be as high as 30 +/- 3 volts.

The TEST position is used by maintenance.

Electrical Power Controls and Monitoring Schematic

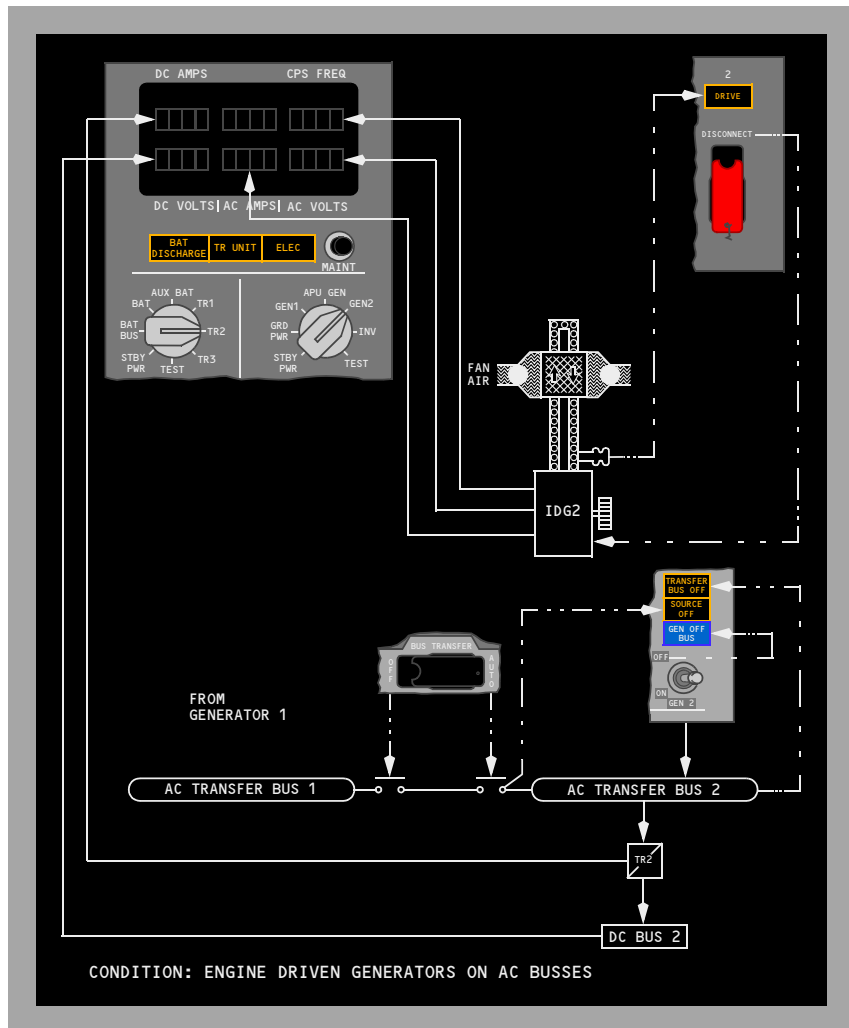

DC Power System

28 volt DC power is supplied by three TR units, which are energized from the AC transfer busses. The battery provides DC power to loads required to be operative when no other source is available.

On the ground, an amber ELEC light comes on to indicate that a fault exists in DC power system or standby power system. The ELEC light is inhibited in flight.

Transformer Rectifier Units

The TRs convert 115 volt AC to 28 volt DC, and are identified as TR1, TR2, and TR3.

TR1 receives AC power from transfer bus 1. TR2 receives AC power from transfer bus 2. TR3 normally receives AC power from transfer bus 2 and has a backup source of AC power from transfer bus 1. Any two TRs are capable of supplying the total connected load.

Under normal conditions, DC bus 1, DC bus 2, and the DC standby bus are connected via the cross bus tie relay. In this condition, TR1 and TR2 are each powering DC bus 1, DC bus 2, and the DC standby bus. TR3 powers the battery bus and serves as a backup power source for TR1 and TR2.

The cross bus tie relay automatically opens, isolating DC bus 1 from DC bus 2, under the following conditions:

- At glide slope capture during a flight director or autopilot ILS approach. This isolates the DC busses during approach to prevent a single failure from affecting both navigation receivers and flight control computers
- Bus transfer switch positioned to OFF.

In-flight, an amber TR UNIT light illuminates if TR1, or TR2 and TR3 has failed. On the ground, any TR fault causes the light to illuminate.

Battery Power

Dual Battery

Two 24 volt nickel-cadmium batteries, main and auxiliary, are located in the electronics compartment. The batteries can supply part of the DC system. The auxiliary battery operates in parallel with the main battery when the battery is powering the standby system. At all other times, the auxiliary battery is isolated from the power distribution system. Battery charging is automatically controlled. Two fully charged batteries have sufficient capacity to provide standby power for a minimum of 60 minutes. Battery voltage range is 22–30 volts.

DC busses powered from the battery following a loss of both generators are:

- battery bus
- DC standby bus

737 Flight Crew Operations Manual

- hot battery bus
- switched hot battery bus.

The switched hot battery bus is powered whenever the battery switch is ON.

The hot battery bus is always connected to the battery. There is no switch in this circuit. The battery must be above minimum voltage to operate units supplied by this bus. An amber BAT DISCHARGE light comes on when excessive battery discharge is detected.

Battery Charger Transformer/Rectifier

Dual Battery

The purpose of the battery chargers is to restore and maintain the batteries at full electrical power. The main battery charger is powered through AC ground service bus 2. The auxiliary battery charger is powered through AC ground service bus 1.

The battery chargers provide a voltage output tailored to maximize the battery charge. Following completion of the primary charge cycle, the main battery charger reverts to a constant voltage TR mode. In the TR mode, it powers loads connected to the hot battery bus and the switched hot battery bus. The main battery charger TR also powers the battery bus if TR3 fails. With loss of AC transfer bus 1 or the source of power to DC bus 1, the AC and DC standby busses are powered by the main and auxiliary battery/battery chargers.

The auxiliary battery charger and battery are isolated from the power distribution system under normal operation. When the main battery is powering the standby system, the auxiliary battery is connected to operate in parallel with the main battery.

DC Power System Schematic

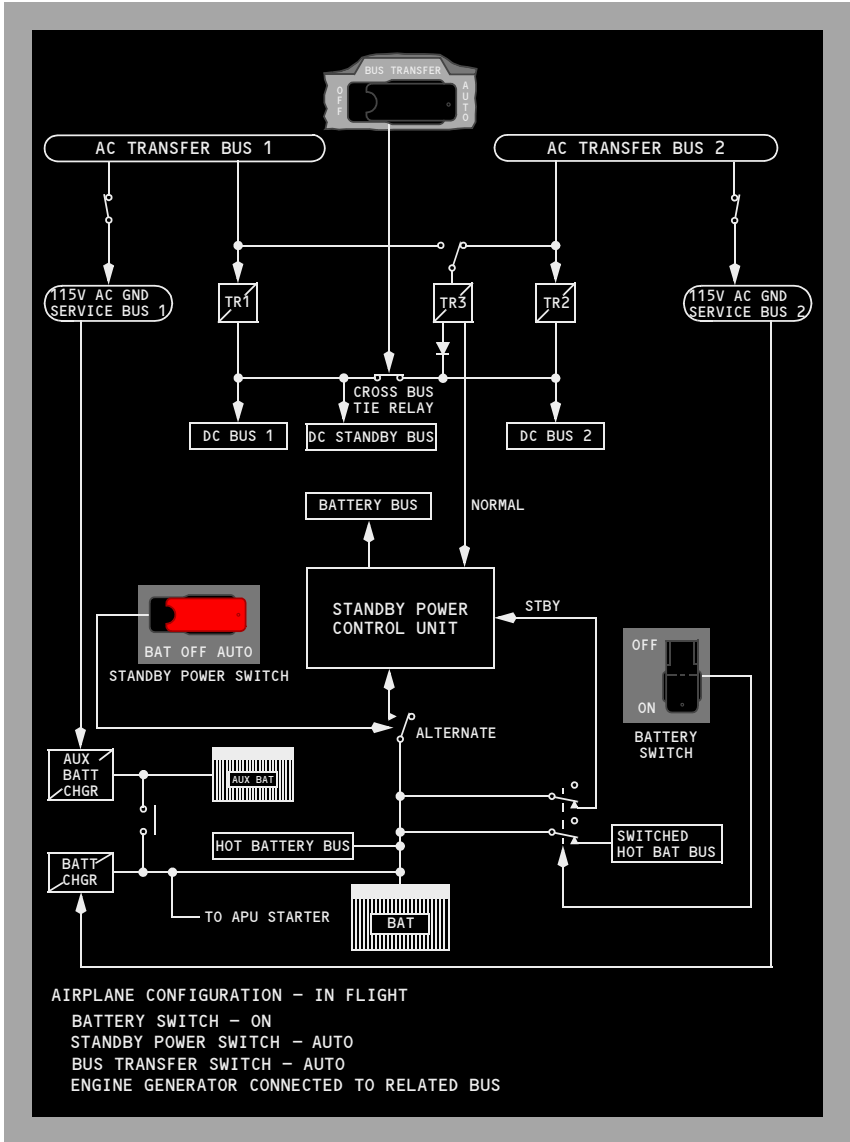

Standby Power System

Normal Operation

The standby system provides 115V AC and 24V DC power to essential systems in the event of loss of all engine or APU-driven AC power. The standby power system consists of:

- static inverter
- AC standby bus
- DC standby bus
- battery bus
- hot battery bus
- switched hot battery bus
- main battery
- auxiliary battery.

During normal operation the guarded standby power switch is in AUTO and the battery switch is ON. This configuration provides alternate power sources in case of partial power loss as well as complete transfer to battery power if all normal power is lost. Under normal conditions the AC standby bus is powered from AC transfer bus 1. The DC standby bus is powered by TR1, TR2, and TR3; the battery bus is powered by TR3; the hot battery bus and switched hot battery bus are powered by the battery/battery charger.

Alternate Operation

Dual Battery

The alternate power sources for standby power are the main battery and auxiliary battery. With the standby power switch in the AUTO position, the loss of all engine or APU electrical power causes the batteries to power the standby loads, both in the air and on the ground. The AC standby bus is powered from the batteries via the static inverter. The DC standby bus, battery bus, hot battery bus, and switched hot battery bus are powered directly from the batteries.

The standby power switch provides for automatic or manual control of power to the standby buses.

In the AUTO position, automatic switching from normal to alternate power occurs if power from either AC transfer bus 1 or DC bus 1 is lost.

Positioning the switch to BAT overrides automatic switching and places the AC standby bus, DC standby bus, and battery bus on battery power. The battery switch may be ON or OFF. If the battery switch is OFF, the switched hot battery bus is not powered.

Positioning the standby power switch to OFF de-energizes both the AC standby bus and the DC standby bus and illuminates the STANDBY PWR OFF light.

Static Inverter

The static inverter converts 24 volt DC power from the battery to 115V AC power to supply the AC standby bus during the loss of normal electrical power. The power supply to the inverter is controlled by the standby power switch and the battery switch on the overhead panel.

Standby Power System Schematic

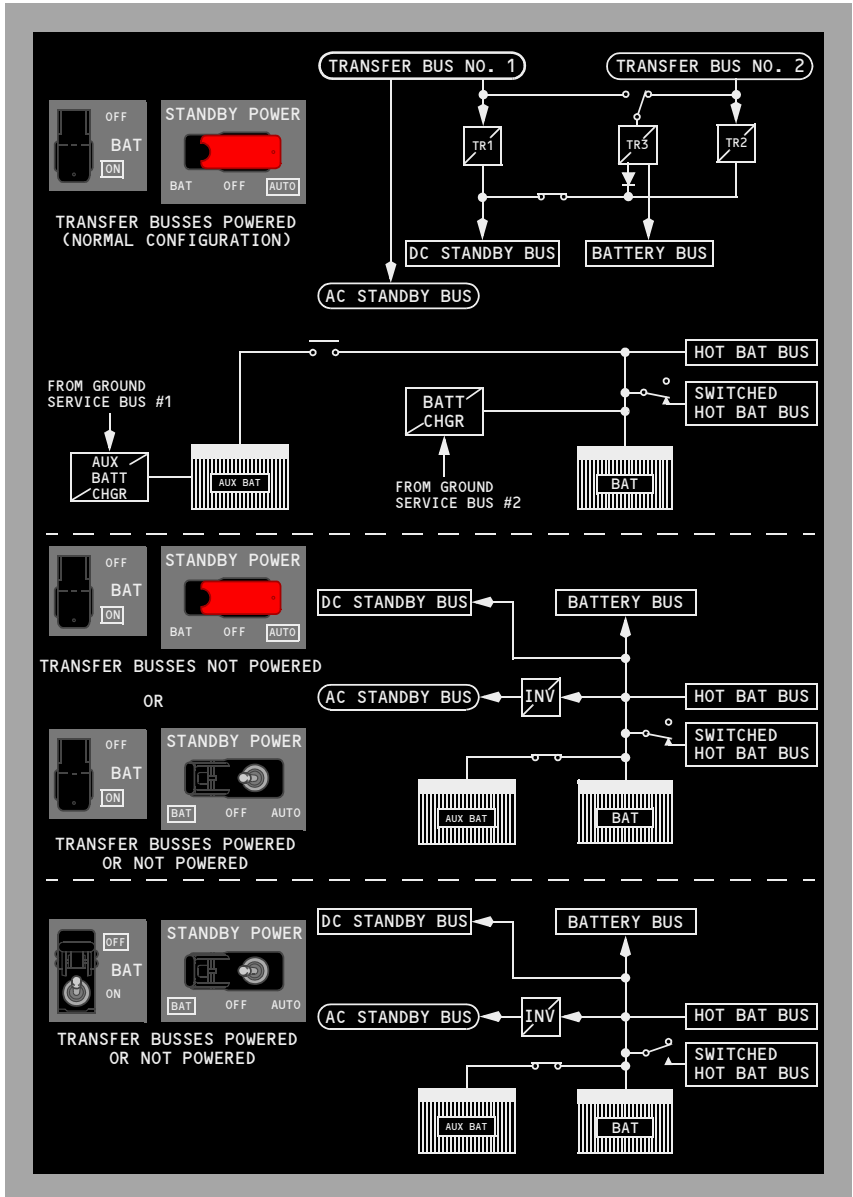

All Generators Inoperative

The following list identifies the significant equipment that operates when the main battery and the auxiliary battery are the only source of electrical power.

Airplane General

- standby compass light
- white dome lights
- emergency instrument flood lights
- flight crew oxygen
- passenger oxygen

Air Systems

- A/C pack valves
- BLEED TRIP OFF lights
- manual pressurization control
- altitude warning horn
YA371 - YA377, YE321 - YE326
- PACK TRIP OFF lights
YC201 - YC207
- PACK lights

Anti-Ice

- Captain's pitot probe heat

Communications

- flight interphone system
- service interphone system
- passenger address system
- VHF No. 1

Electrical

- STANDBY POWER OFF light

Engines, APU

- YA373 - YA377, YC202 - YE326
- upper display unit
N1, N2, fuel flow, EGT, fuel quantity, oil pressure, oil temperature, oil quantity
YA371, YA372, YC201
- upper display unit
N1, N2, fuel flow, EGT, fuel quantity, oil pressure, oil temperature, oil quantity, hydraulic pressure, hydraulic quantity
- thrust reversers
- starter valves

737 Flight Crew Operations Manual

- right igniters
- APU operation (start attempts not recommended above 25,000 feet)

Fire Protection

- APU and engine fire extinguisher bottles
- APU and engine fire detection system
- Cargo fire extinguisher bottles

Flight Instruments

- YA371, YA372, YC201
- Captain's outboard display unit
mach/airspeed indicator, RDMI, attitude indicator, HSI
YA371, YA372, YC201
- Captain's inboard display unit
altimeter, vertical speed indicator, navigation display
YA373 - YA377, YC202 - YE326
- Captain's outboard display unit with primary flight display.
YA373 - YA377, YC202 - YE326
- Captain's inboard display unit with navigation display
- clocks
- left EFIS control panel
YA373, YC202, YE324, YE325
- Standby instruments
radio magnetic indicator (RMI), standby airspeed/altimeter, standby
attitude indicator, standby magnetic compass
YA371, YA372, YA374 - YC201, YC203 - YE323, YE326
- Standby instruments
integrated standby flight instrument display (ISFD), radio magnetic
indicator (RMI), standby magnetic compass

Flight Management, Navigation

- left FMC
- left CDU
YA371, YA372, YC201
- radio distance magnetic indicator (RDMI)
YA371, YA372, YC201
- full horizontal situation indicator (HSI)
YA373 - YA377, YC202 - YE326
- heading/track indications
- VHF NAV No. 1
- ILS No. 1
- left IRS
- left GPS

- marker beacon
- ADF No. 1
- transponder No. 1
- DME No. 1

Fuel

- crossfeed valve
- engine fuel shutoff valves
- spar fuel shutoff valve
- FUEL VALVE CLOSED lights
- fuel quantity indicators

Hydraulic Power

- engine hydraulic shutoff valves
- standby rudder shutoff valves

Landing Gear

- inboard antiskid system
- ANTISKID INOP light
- parking brake
- air/ground system
- landing gear indicator lights

Warnings

- stall warning system
- aural warnings
- master caution light recall

Basic Equipment Operating – Captain Instrument Panel

The standby power system utilizes the battery as a source of power to supply the below depicted flight instruments. All of the Captain's instruments that are powered by standby power are integrally lighted on standby power

737 Flight Crew Operations Manual

YA373, YC202, YE324, YE325

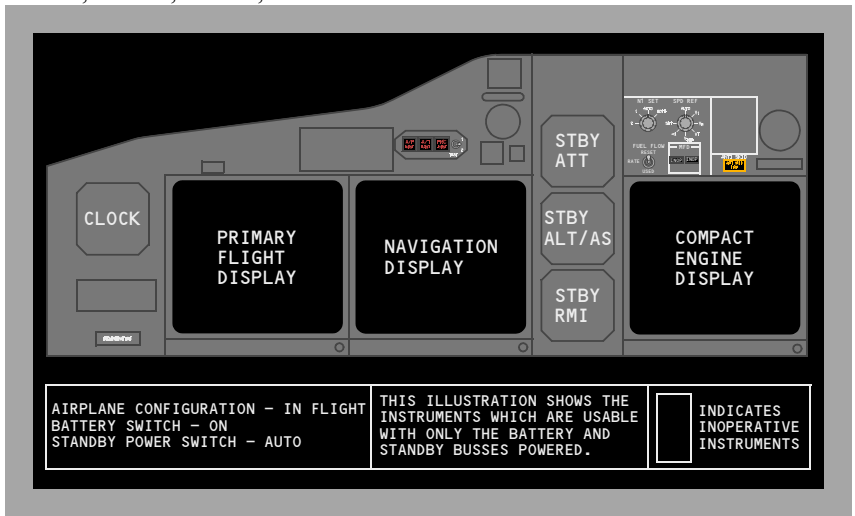

YA371, YA372, YC201

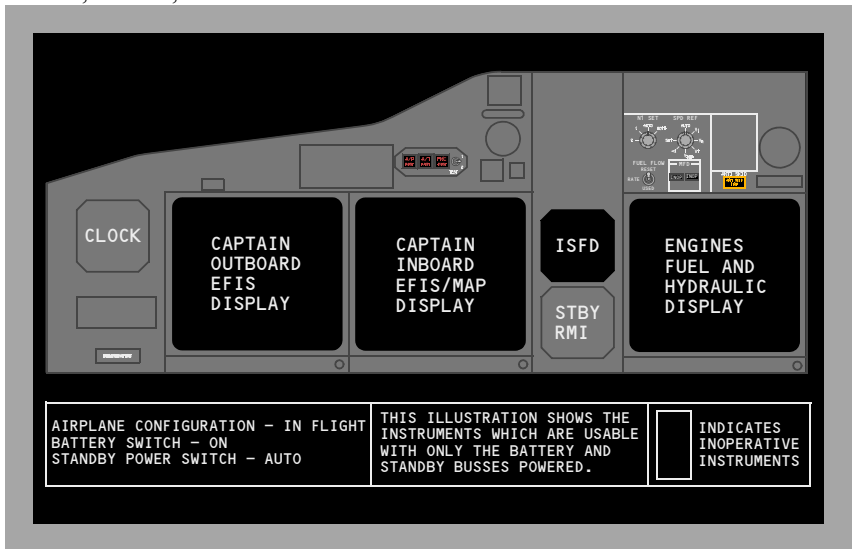

YA374 - YA377, YC203 - YE323, YE326

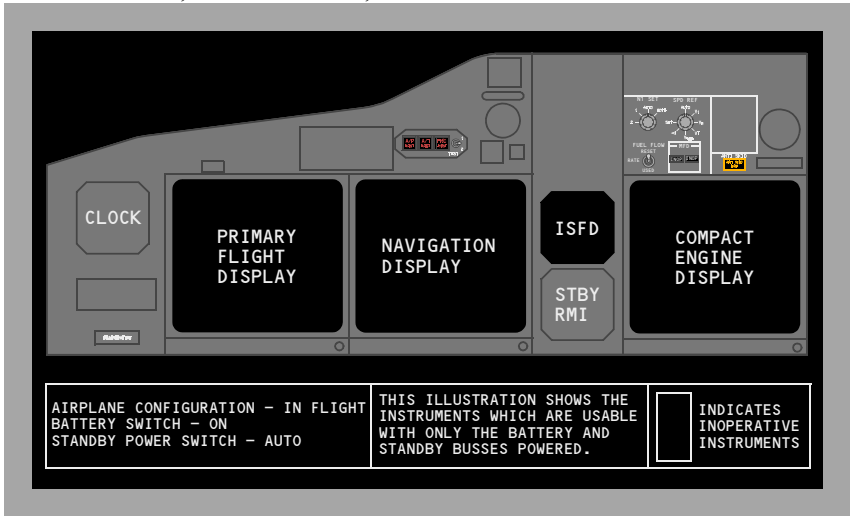

Basic Equipment Operating – First Officer Instrument Panel

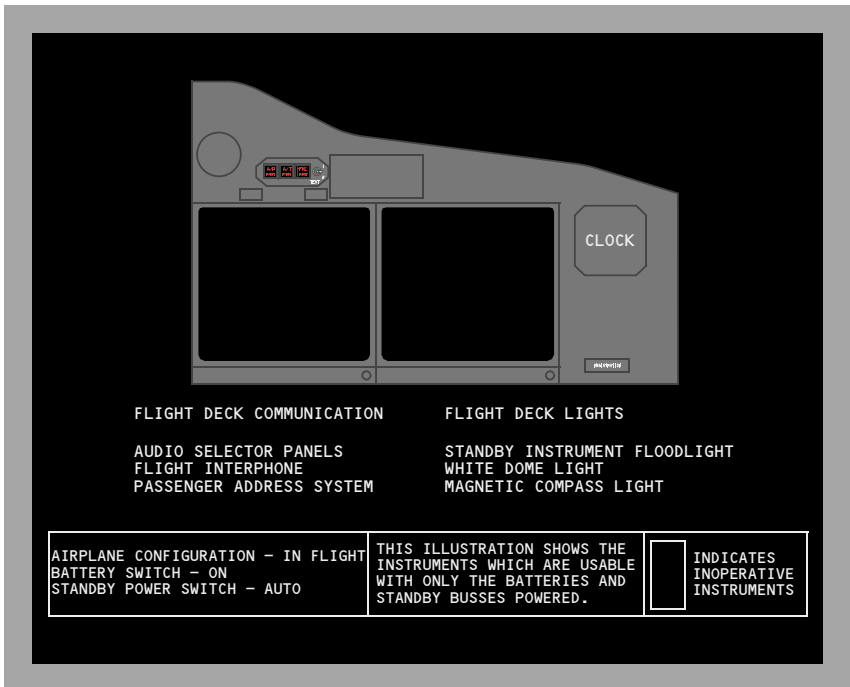



Side by Side – Displays	7.10.1
Primary and Secondary Engine Indications	7.10.1
Autothrottle Limit, Thrust Mode Display and Total	
Air Temperature	7.10.2
N1 Indications	7.10.3
Thrust Reverser Indications	7.10.4
Thermal Anti-Ice Indication	7.10.5
EGT Indications	7.10.6
Engine Fail Alert	7.10.7
N2 Indications	7.10.8
Crossbleed Start Indication	7.10.8
Fuel Flow/Fuel Used Indications	7.10.9
Crew Alerts	7.10.10
Engine Oil Indications	7.10.11
Engine Vibration Indications	7.10.12
Over/Under – Displays	7.11.1
Primary Engine Indications	7.11.1
Total Air Temperature, Thrust Mode Display,	
Selected Temperature and Autothrottle Limit	7.11.2
N1 Indications	7.11.3
Thrust Reverser Indications	7.11.5
Thermal Anti-Ice Indication	7.11.5
EGT Indications	7.11.5
Engine Fail Alert	7.11.6
Crew Alerts	7.11.7
Secondary Engine Indications	7.11.9
N2 Indications	7.11.10
Crossbleed Start Indication	7.11.10
Fuel Flow/Fuel Used Indications	7.11.11
Oil Pressure Indications	7.11.12

Oil Temperature Indications	7.11.13
Oil Quantity Indications	7.11.13
Engine Vibration Indications	7.11.14
Compact Engine Displays	7.11.15
General Controls and Indicators	7.15.1
Engine Start Switches	7.15.1
Engine Display Control Panel	7.15.2
Engine Panel	7.15.4
Engine Controls	7.15.5
APU	7.15.6
Engine System Description	7.20.1
Introduction	7.20.1
Engine Indications	7.20.1
Engine Indications	7.20.2
Primary Engine Indications	7.20.2
Secondary Engine Indications	7.20.2
Normal Display Format	7.20.3
Compact Display	7.20.4
Electronic Engine Control (EEC)	7.20.4
EEC Normal Mode	7.20.4
EEC Alternate Mode	7.20.5
Structural Limit Protection	7.20.5
Idle Operation	7.20.5
Power Plant Schematic	7.20.6
Engine Fuel System	7.20.7
Engine Oil System	7.20.7
Engine Fuel and Oil System Schematic	7.20.8
Engine Start System	7.20.9
Abnormal Start Protection (Ground Starts Only)	7.20.9
Engine Ignition System	7.20.9
Inflight Starting	7.20.10

737 Flight Crew Operations Manual

Engine Start and Ignition System Schematic	7.20.11
Thrust Reverser	7.20.12
Thrust Reverser Schematic	7.20.14
APU System Description	7.30.1
Introduction	7.30.1
APU Location	7.30.1
APU Operation	7.30.1
APU Fuel Supply	7.30.1
APU Engine and Cooling Air	7.30.2
Electrical Requirements for APU Operation	7.30.2
APU Start	7.30.2
APU Shutdown	7.30.3
Electronic Control Unit (ECU)	7.30.3
APU Automatic Load Shedding	7.30.3



Intentionally
Blank

This Section Applies to YA371, YA372, YC201

Primary and Secondary Engine Indications



1 Primary Engine Indications

2 Fuel Quantity Indications

Refer to Chapter 12, Fuel.

3 Secondary Engine Indications

4 Hydraulic Indications

Refer to Chapter 13, Hydraulics.

Autothrottle Limit, Thrust Mode Display and Total Air Temperature

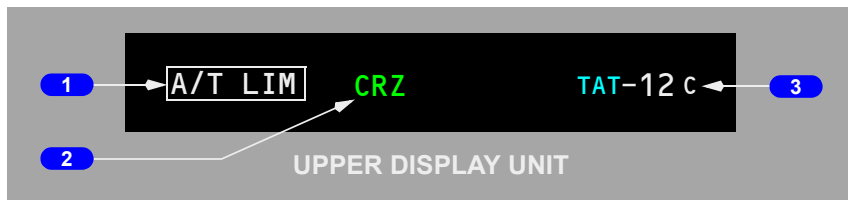

1 Autothrottle Limit (A/T LIM) Indication

Illuminated (white) – The FMC is not providing the A/T system with N1 limit values. The A/T is using a degraded N1 thrust limit from the related EEC.

2 Thrust Mode Display

Displayed (green) – the active N1 limit reference mode.

With N1 manual select knob on engine display control panel in AUTO, active N1 limit is displayed by reference N1 bugs.

Active N1 limit is normally calculated by FMC.

Thrust mode display annunciations are:

- R-TO – reduced takeoff
- R-CLB – reduced climb
- TO – takeoff
- CLB – climb
- CRZ – cruise
- G/A – go-around
- CON – continuous
- ---- FMC not computing thrust limit.

Note: R-TO does not indicate the type of reduced takeoff. The N1 limit may be reduced due to the entry of an assumed temperature, a takeoff thrust derate or a combination of both assumed temperature and takeoff thrust derate.

3 Total Air Temperature (TAT) Indication

Displayed (label –cyan, temp – white) – total air temperature (degrees C).

N1 Indications

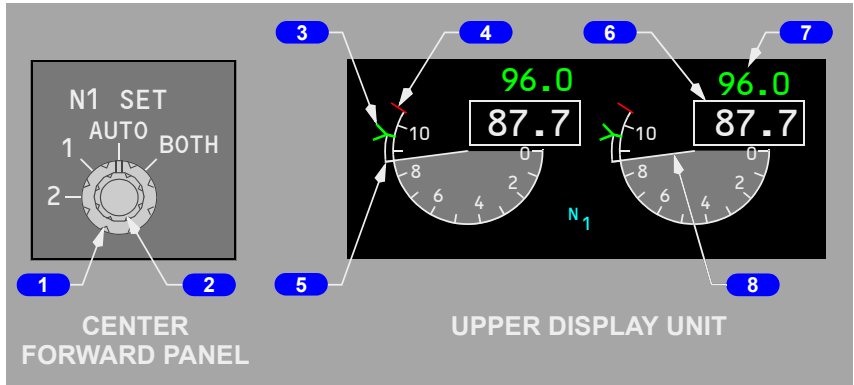

1 N1 SET Outer Knob

AUTO –

- both reference N1 bugs set by FMC based on N1 limit page and takeoff reference page
- displays reference N1 bugs at active N1 limit for A/T.

BOTH –

- both reference N1 bugs and readouts manually set by turning N1 SET inner knob
- has no effect on A/T operation.

1 or 2 –

- respective N1 reference bug and readout manually set by turning N1 SET inner knob
- has no effect on A/T operation.

2 N1 SET Inner Knob (spring-loaded to center)

Rotate – positions reference N1 bug(s) and readouts when N1 SET outer knob is set to BOTH, 1, or 2.

3 Reference N1 Bugs

Displayed (green) – with N1 SET outer knob in AUTO, 1, 2 or BOTH position.

4 N1 Redlines

Displayed (red) – N1% RPM operating limit

5 N1 Command Sectors

Displayed (white) – momentary difference between actual N1 and value commanded by thrust lever position.

6 N1 RPM Readouts (digital)

Displayed (white) – normal operating range.

Displayed (red) –

- operating limit exceeded
- on ground after engine shutdown, red box indicates an inflight exceedance has occurred.

7 Reference N1 Readouts

Displayed (green) –

- manually set N1% RPM when N1 SET outer knob is in BOTH, 1, or 2 position
- ---- when N1 SET outer knob is in AUTO position and FMC source invalid.
- blank when N1 SET outer knob is in AUTO position

Not Displayed when Reverse Thrust is selected.

8 N1 RPM Indications

Displays N1% RPM:

- displayed (white) – normal operating range
- displayed (red) – operating limit exceeded.

Thrust Reverser Indications

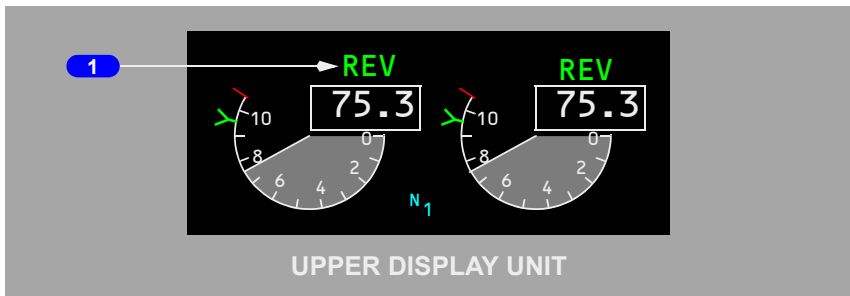

1 Thrust Reverser (REV) Indications

Displayed (amber) – thrust reverser is moved from stowed position.

Displayed (green) – thrust reverser is deployed.

Thermal Anti-Ice Indication

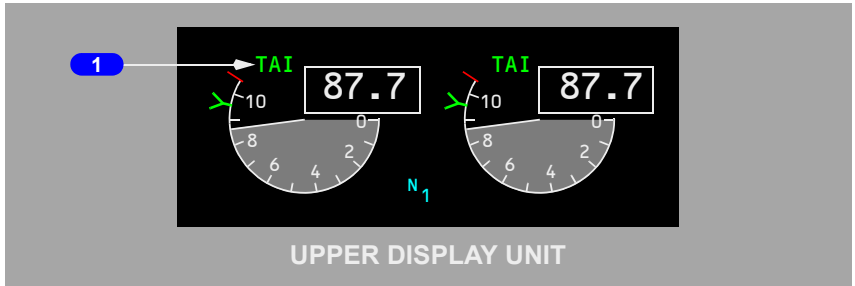

1 Thermal Anti-Ice (TAI) Indications

Displayed (green) – cowl anti-ice valve(s) open.

Displayed (amber) – cowl anti-ice valve is not in position indicated by related engine anti-ice switch.

EGT Indications

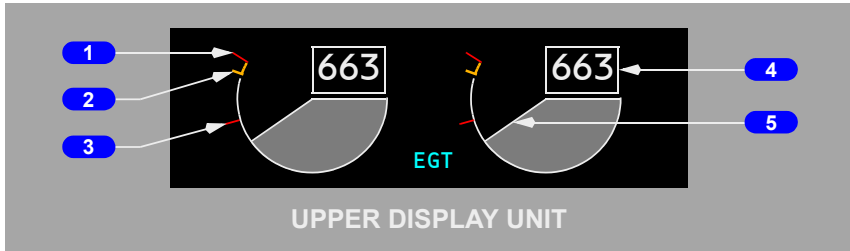

1 Exhaust Gas Temperature (EGT) Redlines

Displayed (red) – maximum takeoff EGT limit.

2 Exhaust Gas Temperature (EGT) Amber Bands

Displayed (amber) – lower end of band displays maximum continuous EGT limit.

3 Exhaust Gas Temperature (EGT) Start Limit Lines

Displayed (red) – until the engine achieves stabilized idle (approximately 59% N₂).

4 Exhaust Gas Temperature (EGT) Readouts (digital)

Displayed (white) – normal operating range (degrees C)

Displayed (amber) – maximum continuous limit exceeded; color change inhibited for up to 5 minutes during takeoff or go-around

Displayed (red) – maximum takeoff limit or start limit exceeded

On ground, after both engines are shut down, red box indicates an exceedance has occurred

EEC senses conditions that may lead to hot start during ground starts (blinking white box).

5 Exhaust Gas Temperature (EGT) Indications

Displayed (white) – normal operating range.

Displayed (amber) – maximum continuous limit exceeded; color change inhibited for up to 5 minutes during takeoff or go-around

Displayed (red) – maximum takeoff limit or start limit exceeded.

Engine Fail Alert

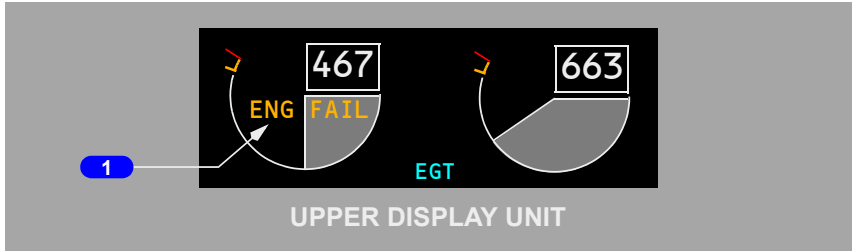

1 Engine Fail (ENG FAIL) Alert

Displayed (amber) –

- engine N2 below sustainable idle (less than 50%); and
- engine start lever in IDLE position.

Alert remains until –

- engine N2 above sustainable idle (50% or greater); or
- start lever moved to CUTOFF; or
- engine fire warning switch pulled.

N2 Indications

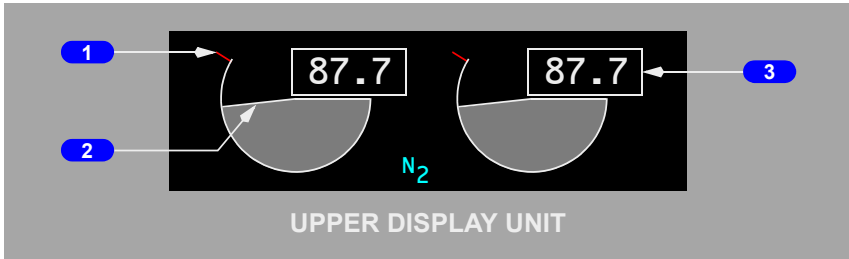

1 N2 Redlines

Displayed (red) – N2 % RPM operating limit.

2 N2 RPM Indications

Displays N2 % RPM

- displayed (white) – normal operating range
- displayed (red) – operating limit exceeded.

3 N2 Readouts (digital)

Displayed (white) – normal operating range.

Displayed (red) –

- operating limit exceeded
- on ground, after engine shutdown, red box indicates an inflight exceedance has occurred.

Crossbleed Start Indication

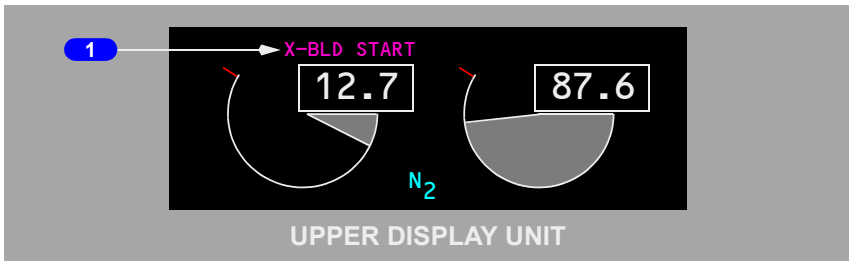

1 Crossbleed (X-BLD) START Indication

Displayed (magenta) – crossbleed air recommended for inflight start.

Displayed when airspeed is less than required for a windmilling start.

Fuel Flow/Fuel Used Indications

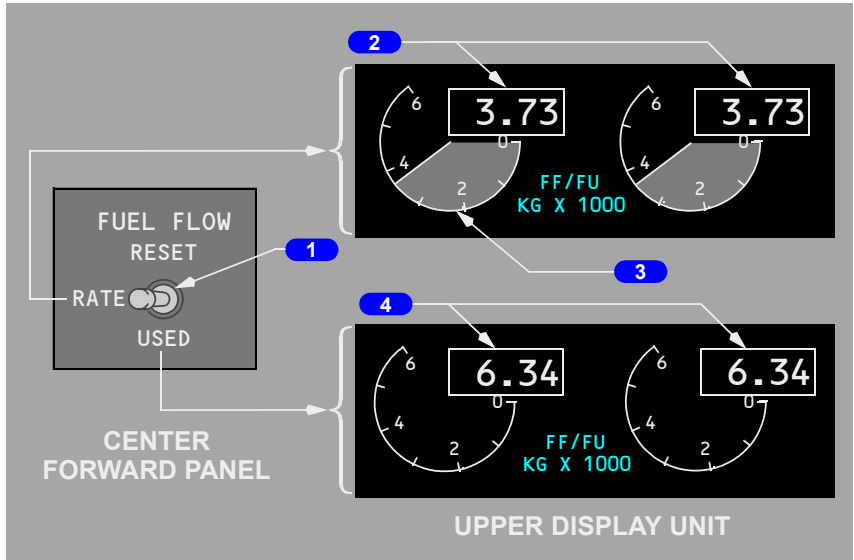

1 FUEL FLOW Switch (spring-loaded to RATE)

RATE – displays fuel flow to engine.

USED –

- pointer and shading are removed
- displays fuel used since last reset
- after 10 seconds, display automatically reverts to fuel flow.

RESET –

- pointer and shading are removed
- resets fuel used to zero
- displays fuel used momentarily, decreases to zero, then displays fuel flow.

2 Fuel Flow (FF) Readout (digital)

Displayed (white) – fuel flow to engine with FUEL FLOW switch in RATE position (kilograms per hour x 1000).

3 Fuel Flow (FF) Dial/ Index Markers & Digits (white)

Displayed (white) – fuel flow to engine with FUEL FLOW switch in RATE position (kilograms per hour x 1000).

4 Fuel Used (FU) Readout (digital)

Displayed (white) – when FUEL FLOW switch moved to USED or RESET.

Crew Alerts

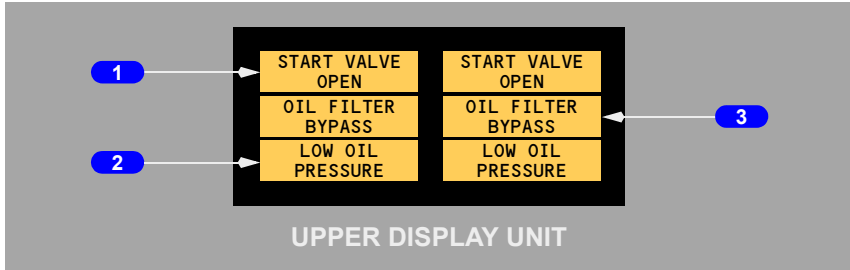

1 START VALVE OPEN Alert

Illuminated (amber) –

- steady – respective engine start valve open and air is supplied to starter
- blinking – uncommanded opening of start valve. Alert is displayed and solid amber boxes are displayed in unannunciated positions for that engine. All three boxes blink for ten seconds, then alert remains on steady and solid amber boxes are removed (see Note).

2 LOW OIL PRESSURE Alert

Illuminated (amber) –

- steady – oil pressure at or below red line
- blinking – with a condition of low oil pressure. Alert is displayed and solid amber boxes are displayed in unannunciated positions for that engine. All three boxes blink for ten seconds, then alert remains on steady and solid amber boxes are removed (see Note).

3 OIL FILTER BYPASS Alert

Illuminated (amber) –

- steady – indicates an impending bypass of scavenge oil filter
- blinking – with an impending bypass. Alert is displayed and solid amber boxes are displayed in unannunciated positions for that engine. All three boxes blink for ten seconds, then alert remains on steady and solid amber boxes are removed (see Note).

Note: Blinking is inhibited:

- during takeoff from 80 knots to 400 feet RA, or 30 seconds after reaching 80 knots, whichever occurs first
- during landing below 200 feet RA until 30 seconds after touchdown
- during periods when blinking is inhibited, alerts illuminate steady.

Engine Oil Indications

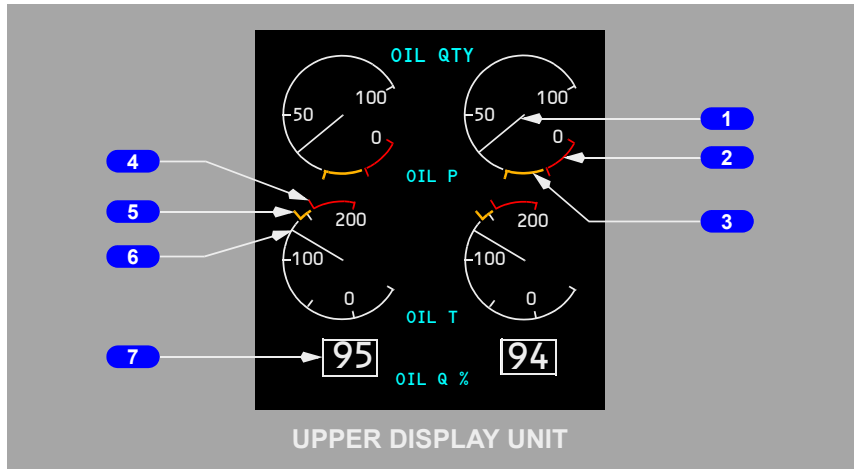

1 Oil Pressure (OIL P) Indication

Displays engine oil pressure (psi)

- displayed (white) – normal operating range
- displayed (amber) – caution range
- displayed (red) – operating limit reached.

2 Low Oil Pressure (OIL P) Redline

Displayed (red) – oil pressure operating limit.

3 Low Oil Pressure (OIL P) Amber Band

Displayed (amber) – low oil pressure caution range beginning at red line:

- variable depending on N2% RPM above 65% N2
- amber band not displayed below 65% N2.

4 High Oil Temperature (OIL T) Redline

Displayed (red) – oil temperature operating limit.

5 High Oil Temperature (OIL T) Amber Band

Displayed (amber) – oil temperature caution range.

6 Oil Temperature (OIL T) Indication

Displays oil temperature (degrees C):

- displayed (white) – normal operating range
- displayed (amber) – caution range reached
- displayed (red) – operating limit reached.

7 Oil Quantity (OIL Q)% Readout

Displays usable oil quantity as a percentage of full quantity.

Note: Indicated oil quantity may decrease significantly during engine start, takeoff and climb out. If this occurs, engine operation is not impacted and the correct oil quantity should be indicated during level flight.

Note: An oil quantity indication as low as zero is normal if windmilling N2 RPM is below approximately 8%.

Engine Vibration Indications

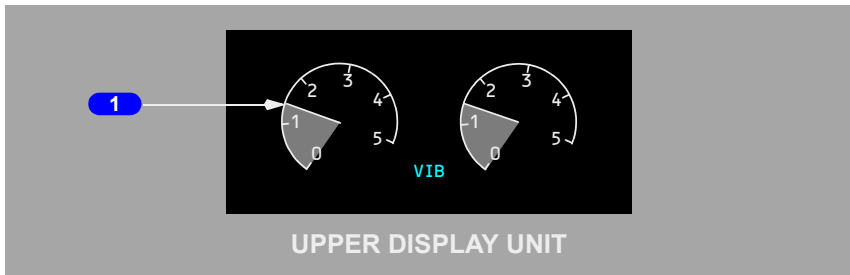

1 Vibration (VIB) Pointer

Displayed (white) – engine vibration level.

This Section Applies to YA373 - YA377, YC202 - YE326

Primary Engine Indications

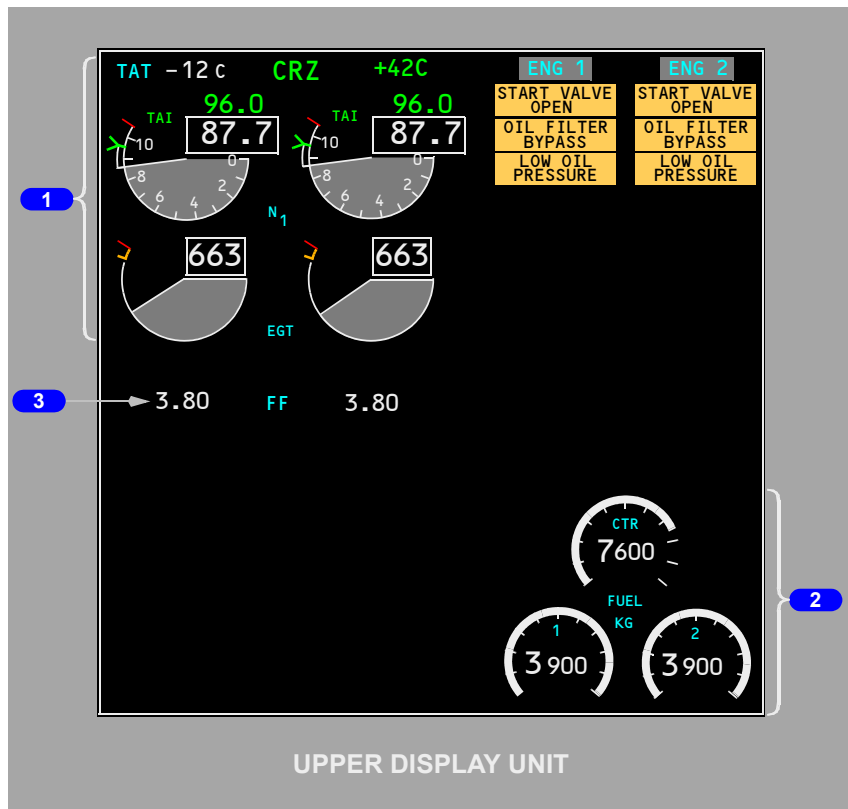

1 Primary Engine Indications

2 Fuel Quantity Indications

Refer to Chapter 12, Fuel

3 Fuel Flow Indications

Total Air Temperature, Thrust Mode Display, Selected Temperature and Autothrottle Limit

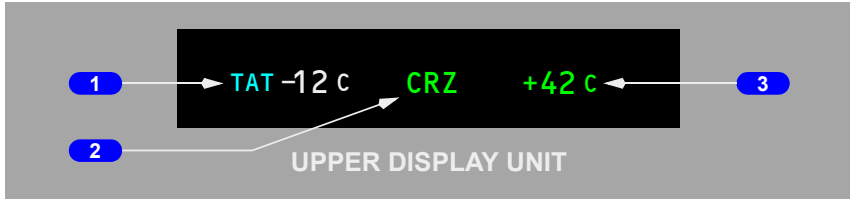

1 Total Air Temperature (TAT) Indication

Displayed (label – cyan, temp – white) – total air temperature (degrees C).

2 Thrust Mode Display

Displayed (green) – the active N1 limit reference mode.

With N1 manual select knob on engine display control panel in AUTO, active N1 limit is displayed by reference N1 bugs.

Active N1 limit is normally calculated by FMC.

Thrust mode display annunciations are:

- R-TO – reduced takeoff
- R-CLB – reduced climb
- TO – takeoff
- CLB – climb
- CRZ – cruise
- G/A – go-around
- CON – continuous
- – – – – FMC not computing thrust limit.

Note: R-TO does not indicate the type of reduced takeoff. The N1 limit may be reduced due to the entry of an assumed temperature, a takeoff thrust derate or a combination of both assumed temperature and takeoff thrust derate.

3 Selected Temperature

Displayed (green) – selected assumed temperature (degrees C) for reduced thrust takeoff N1.

Repeats data selected on TAKEOFF REF page.

4 Autothrottle Limit (A/T LIM) Indication

Illuminated (white) – The FMC is not providing the A/T system with N1 limit values. The A/T is using a degraded N1 thrust limit from the related EEC.

Replaces thrust mode display annunciation when illuminated.

N1 Indications

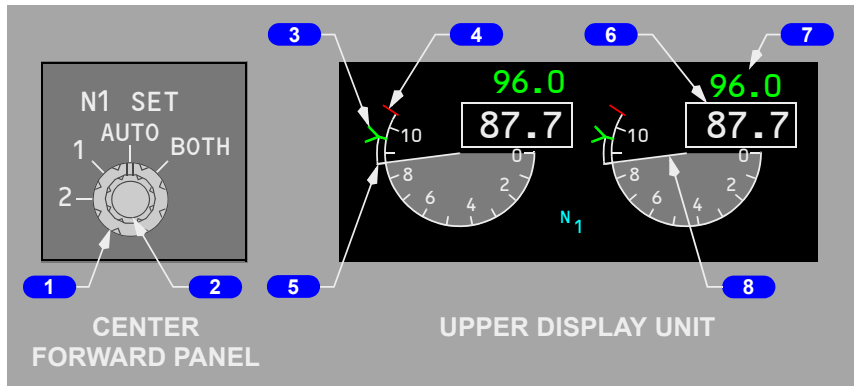

1 N1 SET Outer Knob

AUTO –

- both reference N1 bugs set by FMC based on N1 limit page and takeoff reference page
- displays reference N1 bugs at active N1 limit for A/T.

BOTH –

- both reference N1 bugs and readouts manually set by turning N1 SET inner knob
- has no effect on A/T operation.

1 or 2 –

- respective N1 reference bug and readout manually set by turning N1 SET inner knob
- has no effect on A/T operation.

2 N1 SET Inner Knob (spring-loaded to center)

Rotate – positions reference N1 bug(s) and readouts when N1 SET outer knob is set to BOTH, 1, or 2.

3 Reference N1 Bugs

Displayed (green) – with N1 SET outer knob in AUTO, 1, 2 or BOTH position. Position corresponds to digital value on the Reference N1 Readout.

4 N1 Redlines

Displayed (red) – N1% RPM operating limit

5 N1 Command Sectors

Displayed (white) – momentary difference between actual N1 and value commanded by thrust lever position.

6 N1 RPM Readouts (digital)

Displayed (white) – normal operating range.

Displayed (red) –

- operating limit exceeded
- on ground after engine shutdown, red box indicates an inflight exceedance has occurred.

7 Reference N1 Readouts

Displayed (green) –

- manually set N1% RPM when N1 SET outer knob is in BOTH, 1, or 2 position
- ---- when N1 SET outer knob is in AUTO position and FMC source invalid.
- blank when N1 SET outer knob is in AUTO position

Not Displayed when Reverse Thrust is selected.

8 N1 RPM Indications

Displays N1% RPM:

- displayed (white) – normal operating range
- displayed (red) – operating limit exceeded.

Thrust Reverser Indications

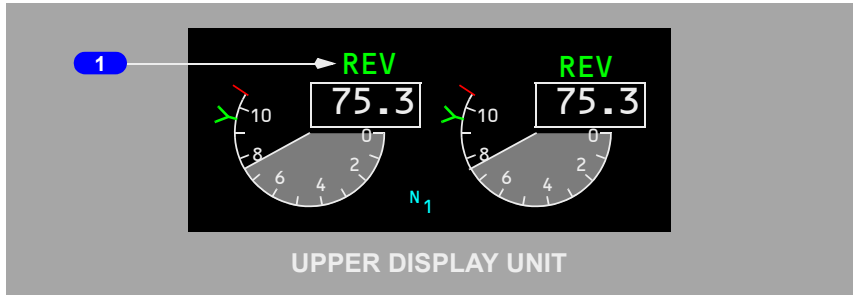

1 Thrust Reverser (REV) Indications

Displayed (amber) – thrust reverser is moved from stowed position.

Displayed (green) – thrust reverser is deployed.

Thermal Anti-Ice Indication

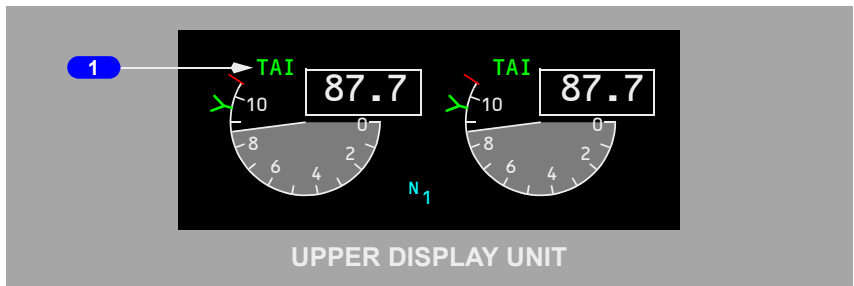

1 Thermal Anti-Ice (TAI) Indications

Displayed (green) – cowl anti-ice valve(s) open.

Displayed (amber) – cowl anti-ice valve is not in position indicated by related engine anti-ice switch.

EGT Indications

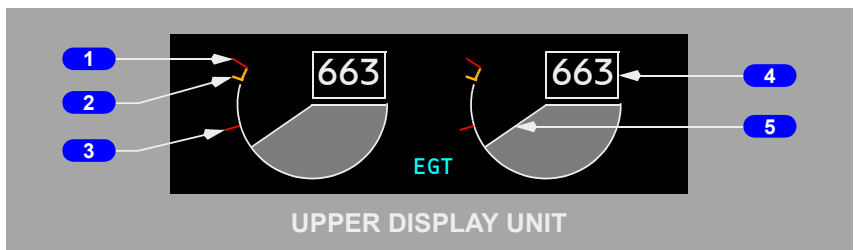

1 Exhaust Gas Temperature (EGT) Redlines

Displayed (red) – maximum takeoff EGT limit.

2 Exhaust Gas Temperature (EGT) Amber Bands

Displayed (amber) – lower end of band displays maximum continuous EGT limit.

3 Exhaust Gas Temperature (EGT) Start Limit Lines

Displayed (red) – until the engine achieves stabilized idle (approximately 59% N2).

4 Exhaust Gas Temperature (EGT) Readouts (digital)

Displayed (white) – normal operating range (degrees C)

Displayed (amber) – maximum continuous limit exceeded; color change inhibited for up to 5 minutes during takeoff or go-around

Displayed (red) – maximum takeoff limit or start limit exceeded

On ground, after both engines are shut down, red box indicates an exceedance has occurred

EEC senses conditions that may lead to hot start during ground starts (blinking white box).

5 Exhaust Gas Temperature (EGT) Indications

Displayed (white) – normal operating range.

Displayed (amber) – maximum continuous limit exceeded; color change inhibited for up to 5 minutes during takeoff or go-around

Displayed (red) – maximum takeoff limit or start limit exceeded.

Engine Fail Alert

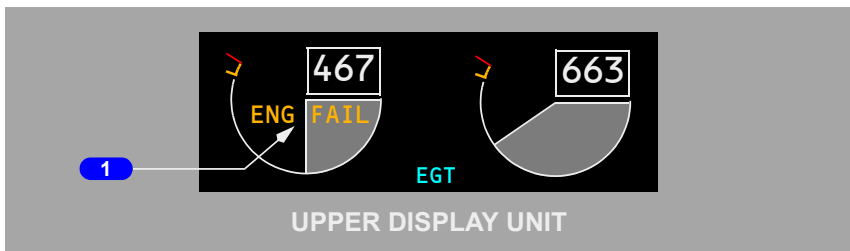

1 Engine Fail (ENG FAIL) Alert

Displayed (amber) –

- engine operating below sustainable idle (less than 50% N2); and
- engine start lever in IDLE position.

Alert remains until –

- engine recovers; or
- start lever moved to CUTOFF; or
- engine fire warning switch pulled.

Crew Alerts

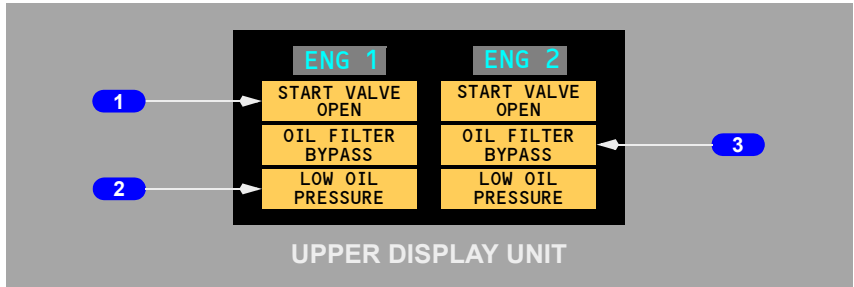

1 START VALVE OPEN Alert

Illuminated (amber) –

- steady – respective engine start valve open and air is supplied to starter
- blinking – uncommanded opening of start valve. Alert is displayed and solid amber boxes are displayed in unannunciated positions for that engine. All three boxes blink for ten seconds, then alert remains on steady and solid amber boxes are removed (see Note).

2 LOW OIL PRESSURE Alert

Illuminated (amber) –

- steady – oil pressure at or below red line
- blinking – with a condition of low oil pressure. Alert is displayed and solid amber boxes are displayed in unannunciated positions for that engine. All three boxes blink for ten seconds, then alert remains on steady and solid amber boxes are removed (see Note).

3 OIL FILTER BYPASS Alert

Illuminated (amber) –

- steady – indicates an impending bypass of scavenge oil filter
- blinking – with an impending bypass. Alert is displayed and solid amber boxes are displayed in unannounced positions for that engine. All three boxes blink for ten seconds, then alert remains on steady and solid amber boxes are removed (see Note).

Note: Blinking is inhibited:

- during takeoff from 80 knots to 400 feet RA, or 30 seconds after reaching 80 knots, whichever occurs first
- during landing below 200 feet RA until 30 seconds after touchdown
- during periods when blinking is inhibited, alerts illuminate steady.

Secondary Engine Indications

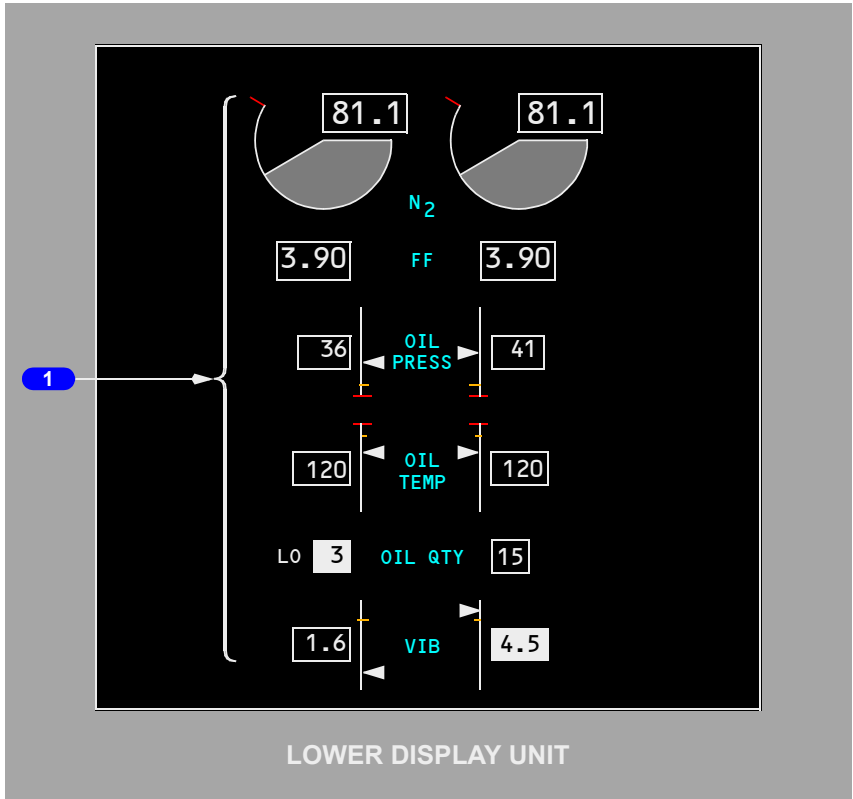

1 Secondary Engine Indications

Secondary engine indications are displayed:

- when CDS initially receives power
- when selected by the Multi-Function Display (MFD)
- in flight when an engine start lever moved to CUTOFF
- in flight when an engine fails
- when a secondary engine parameter exceeds normal operating range.

N2 Indications

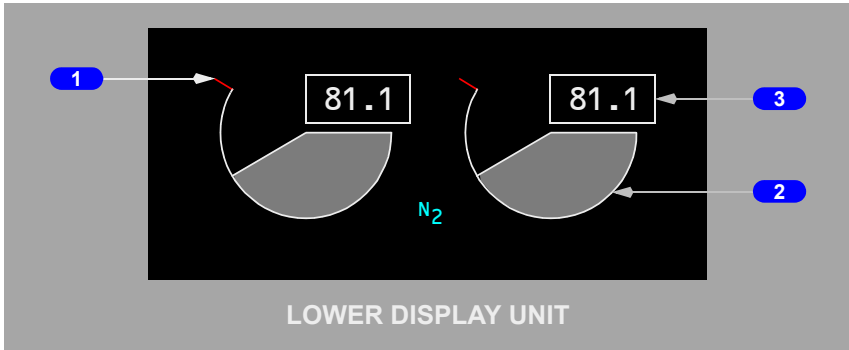

1 N2 Redlines

Displayed (red) – N2% RPM operating limit.

2 N2 RPM Indications

Displays N2% RPM

- displayed (white) – normal operating range
- displayed (red) – operating limit exceeded.

3 N2 Readouts (digital)

Displayed (white) – normal operating range.

Displayed (red) –

- operating limit exceeded
- on ground, after engine shutdown, red box indicates an inflight exceedance has occurred.

Crossbleed Start Indication

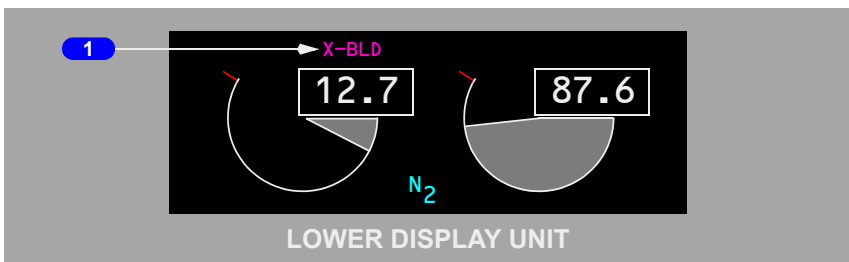

1 Crossbleed Start (X-BLD) Indication

Displayed (magenta) – crossbleed air recommended for inflight start.

Displayed when airspeed is less than required for a windmilling start.

Fuel Flow/Fuel Used Indications

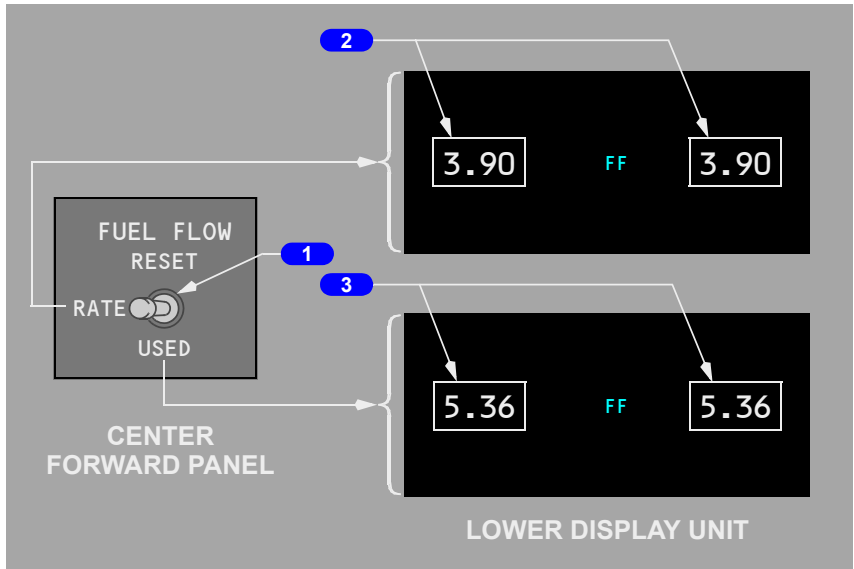

1 FUEL FLOW Switch (spring-loaded to RATE)

RATE – displays fuel flow to engine.

USED –

- displays fuel used since last reset
- after 10 seconds, display automatically reverts to fuel flow.

RESET –

- resets fuel used to zero
- displays fuel used for 1 second, decreases to zero, then displays fuel flow.

2 Fuel Flow (FF) Readout (digital)

Displayed (white) – fuel flow to engine with FUEL FLOW switch in RATE position (kilograms per hour x 1000).

3 Fuel Used Readout (digital)

Displayed (white) – when FUEL FLOW switch moved to USED or RESET.

Oil Pressure Indications

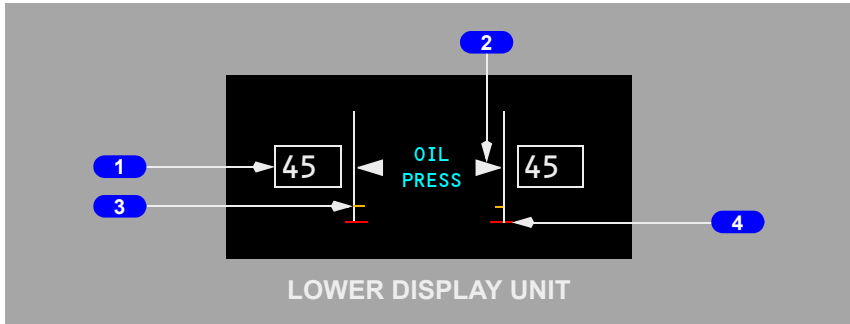

1 Oil Pressure (OIL PRESS) Readout

Displays engine oil pressure (psi)

- displayed (white) – normal operating range
- displayed (amber) – caution range
- displayed (red) – operating limit reached.

2 Oil Pressure (OIL PRESS) Pointer

Displays engine oil pressure:

- displayed (white) – normal operating range
- displayed (amber) – caution range reached
- displayed (red) – operating limit reached.

3 Low Oil Pressure (OIL PRESS) Amber Band

Displayed (amber) – low oil pressure caution range beginning at red line.:

- variable depending on N2% RPM above 65% N2
- amber band not displayed below 65% N2.

4 Low Oil Pressure (OIL PRESS) Redline

Displayed (red) – oil pressure operating limit.

Oil Temperature Indications

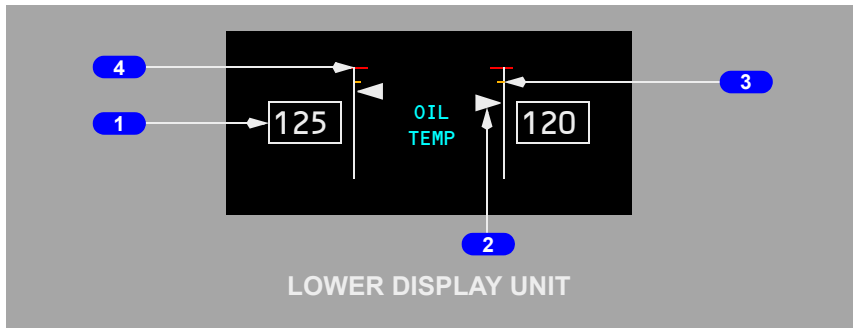

1 Oil Temperature (OIL TEMP) Readout

Displays oil temperature (degrees C):

- displayed (white) – normal operating range
- displayed (amber) – caution range reached
- displayed (red) – operating limit reached.

2 Oil Temperature (OIL TEMP) Pointer

Displays oil temperature (degrees C):

- displayed (white) – normal operating range
- displayed (amber) – caution range reached
- displayed (red) – operating limit reached.

3 High Oil Temperature (OIL TEMP) Amber Band

Displayed (amber) – oil temperature caution range.

4 High Oil Temperature (OIL TEMP) Redline

Displayed (red) – oil temperature operating limit.

Oil Quantity Indications

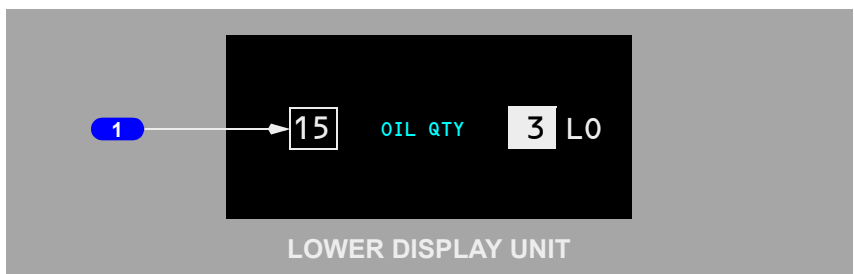

1 Oil Quantity (OIL QTY) Readout

Displays usable oil quantity in quarts.

Video is reversed and LO (white) displayed for low oil quantity.

Note: Indicated oil quantity may decrease significantly during engine start, takeoff and climb out. If this occurs, engine operation is not impacted and the correct oil quantity should be indicated during level flight.

Note: An oil quantity indication as low as zero is normal if windmilling N2 RPM is below approximately 8%.

Engine Vibration Indications

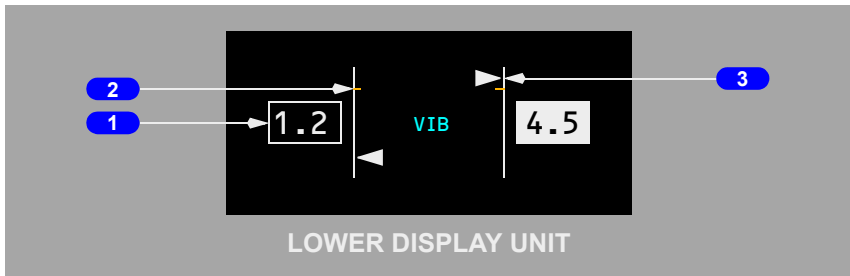

1 Vibration (VIB) Readout

Displayed (white) – engine vibration level.

Video is reversed for high vibration.

2 High Limit

Displays tick mark and thick line.

3 Vibration (VIB) Pointer

Displayed (white) – engine vibration level.

Compact Engine Displays

The following changes occur to the secondary engine display in the compact engine displays.

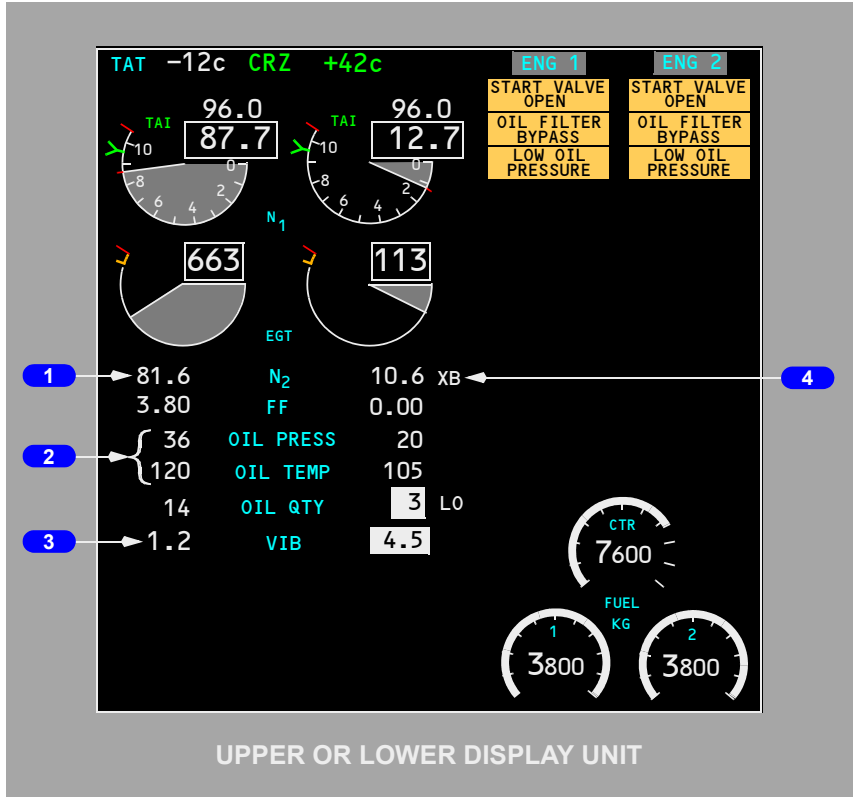

1 N2 RPM Indications

N2 changes from round dial display to a digital display.

The digital display is framed by a red box after engine shutdown on the ground if an inflight exceedance occurred.

2 OIL PRESS, OIL TEMP Indications

Displayed as digital readouts only

The digital readouts display amber or red if limits are exceeded.

3 Vibration (VIB) Indications

Displayed as digital readout only.

4 Crossbleed Start (XB) Indications

Displayed on the side of N2

Engine Start Switches

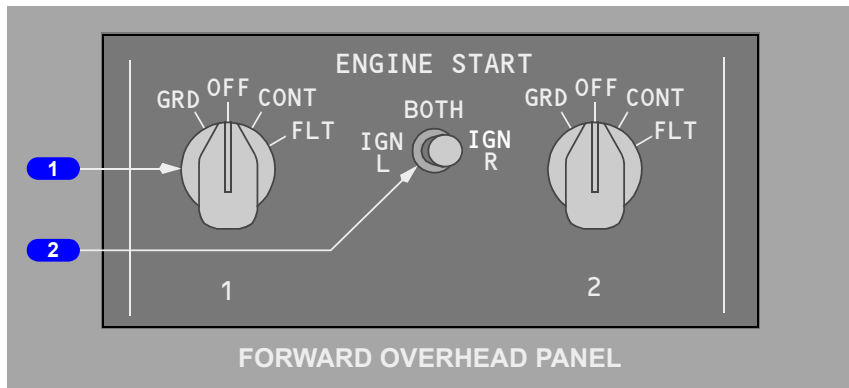

1 ENGINE START Switches

GRD –

- opens start valve
- closes engine bleed valve
- for ground starts, arms selected igniter(s) to provide ignition when engine start lever is moved to IDLE
- for inflight starts, arms both igniters to provide ignition when engine start lever is moved to IDLE
- releases to OFF at start valve cutout.

OFF –

- ignition normally off
- both igniters are activated when engine start lever is in IDLE and:
 - an uncommanded rapid decrease in N2 occurs or,
 - N2 is between 57% and 50% or,
 - in flight - N2 is between idle and 5%.

CONT –

- provides ignition to selected igniters when engine is operating and engine start lever is in IDLE
- in flight - provides ignition to both igniters when N2 is below idle and engine start lever is in IDLE.

FLT – provides ignition to both igniters when engine start lever is in IDLE.

2 Ignition Select Switch

IGN L – selects the left igniter for use on both engines.

BOTH – selects both igniters for use on both engines.

IGN R – selects the right igniter for use on both engines.

Engine Display Control Panel

YA371, YA372, YC201

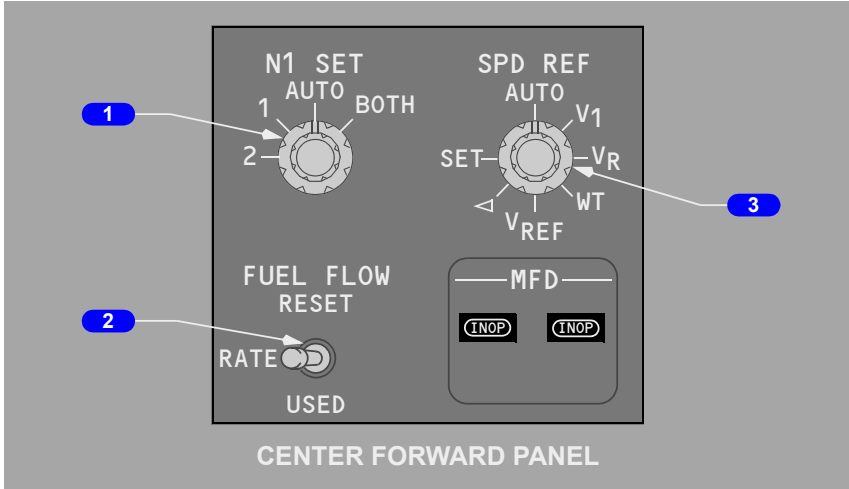

YA373 - YA377, YC202 - YE326

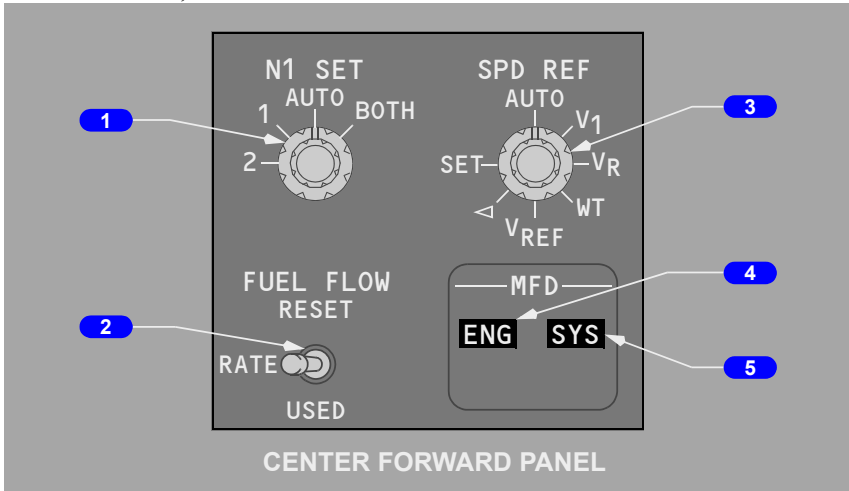

1 N1 SET Knob

YA371, YA372, YC201

Refer to section 10, Side by Side - Displays

YA373 - YA377, YC202 - YE326

Refer to section 11, Over/Under - Displays

2 FUEL FLOW Switch

YA371, YA372, YC201

Refer to section 10, Side by Side - Displays

YA373 - YA377, YC202 - YE326

Refer to section 11, Over/Under - Displays

3 Speed Reference Selector

Refer to Chapter 10, Flight Instruments, Displays.

4 MFD Engine (ENG) Switch

YA373 - YA377, YC202 - YE326

Push – ENG

- displays secondary engine indications on lower DU; or if the lower DU is unavailable, on upper or inboard DU based on the position of the display select panel selector
- second push blanks lower DU.

5 MFD System (SYS) Switch

YA373 - YA377, YC202 - YE326

Refer to Chapter 13, Hydraulics.

Engine Panel

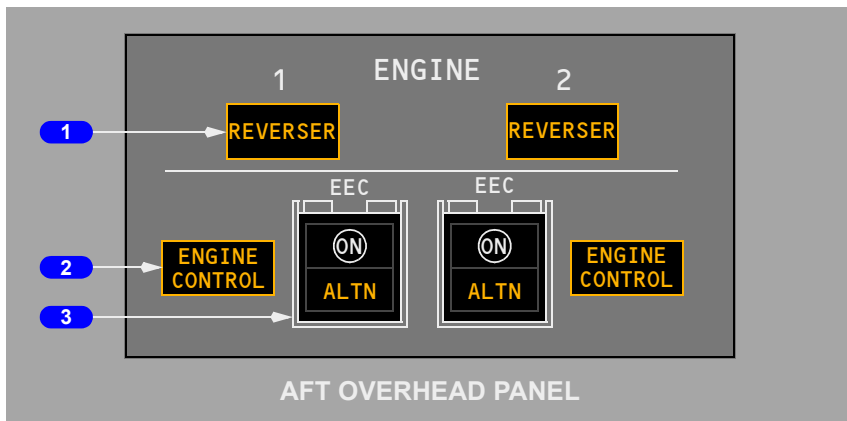

1 REVERSER Lights

Illuminated (amber) – one or more of following has occurred:

- isolation valve or thrust reverser control valve is not in commanded position
- one or more thrust reverser sleeves are not in commanded state
- auto–restow circuit has been activated
- a failure has been detected in synchronization shaft lock circuitry.

2 ENGINE CONTROL Lights

Illuminated (amber) – engine control system is not dispatchable due to faults in system.

Light operates when:

- engine is operating and,
- airplane on ground and:
 - below 80 kt prior to takeoff or,
 - approximately 30 seconds after touchdown.

3 Electronic Engine Control (EEC) Switches

ON – in view (white)

- indicates normal control mode is selected
- engine ratings calculated by EEC from sensed atmospheric conditions and bleed air demand
- when ON is not in view, the EEC has been manually selected to the alternate mode.

737 Flight Crew Operations Manual

ALTN – in view (amber)

- indicated EEC has automatically switched to alternate control mode or it has been selected manually
- EEC provides rated thrust or higher.

Note: Both ON and ALTN may be in view if EEC has automatically switched to soft alternate mode.

Note: EGT limits must be observed in both normal and alternate control modes.

Engine Controls

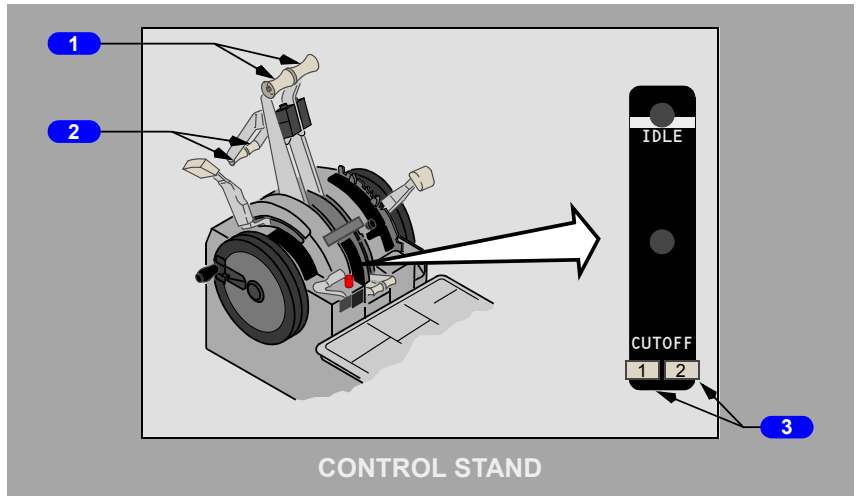

1 Forward Thrust Levers –

- controls engine thrust
- cannot be advanced if the reverse thrust lever is in the deployed position.

2 Reverse Thrust Levers –

- controls engine reverse thrust
- cannot select reverse thrust unless related forward thrust lever is at IDLE.

Note: Reverse thrust lever is blocked at reverse idle position until related thrust reverser is more than 60% deployed.

Note: Movement of reverse thrust lever into reverse thrust engages locking pawl preventing forward thrust lever from moving. Terminating reverse thrust removes locking pawl and restores forward thrust lever movement ability.

3 Engine Start Levers

IDLE –

- energizes ignition system through EEC
- electrically opens spar fuel shutoff valve in the wing leading edge outboard of the pylon
- electrically opens engine–mounted fuel shutoff valve via the EEC.

CUTOFF –

- closes both spar and engine fuel shutoff valves
- de–energizes ignition system.

APU

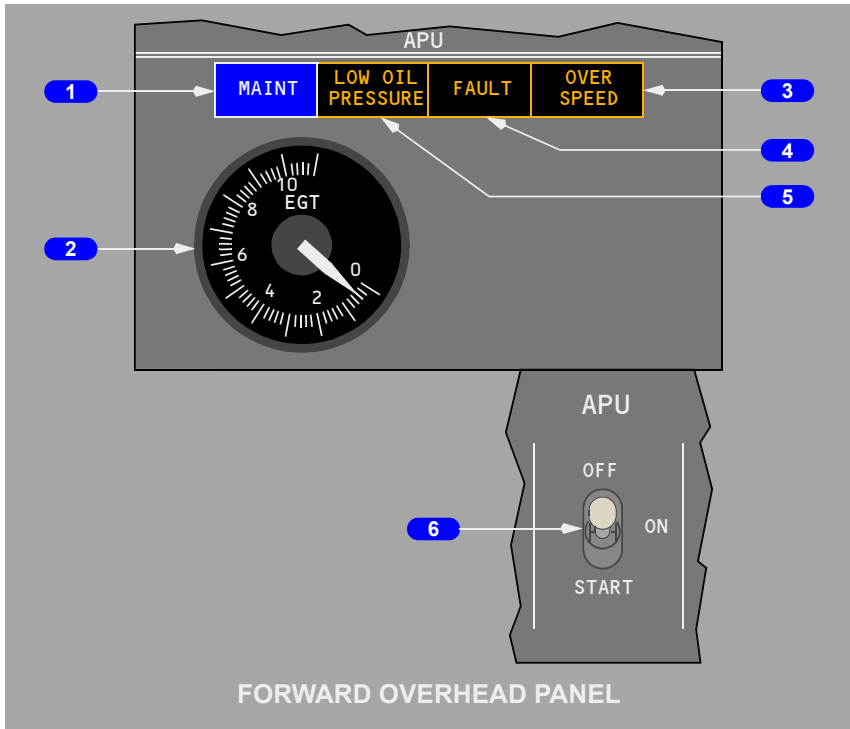

1 APU Maintenance (MAINT) Light

Illuminated (blue) – APU maintenance problem exists:

- APU may be operated
- light is disarmed when APU switch is in OFF.

737 Flight Crew Operations Manual

2 APU Exhaust Gas Temperature (EGT) Indicator

Displays APU EGT

EGT indicator remains powered for 5 minutes after shutdown.

3 APU OVERSPEED Light

Illuminated (amber) –

- APU RPM limit has been exceeded resulting in an automatic shutdown
- overspeed shutdown protection feature has failed a self-test during a normal APU shutdown
- if light is illuminated when APU switch is placed to OFF, light extinguishes after 5 minutes
- light is disarmed when the APU switch is in OFF position.

4 APU FAULT Light

Illuminated (amber) –

- a malfunction exists causing APU to initiate an automatic shutdown
- if light is illuminated when APU switch is placed to OFF, light extinguishes after 5 minutes
- light is disarmed when APU switch is in OFF position.

5 APU LOW OIL PRESSURE Light

Illuminated (amber) –

- during start until the APU oil pressure is normal
- oil pressure is low causing an automatic shutdown (after start cycle is complete)
- if light is illuminated when APU switch is placed to OFF, light extinguishes after 5 minutes
- light is disarmed when APU switch is in OFF position.

6 APU Switch

OFF – normal position when APU is not running

- positioning switch to OFF with APU running trips APU generator off the bus(es), if connected, and closes APU bleed air valve. APU continues to run for a 60 second cooling period
- APU air inlet door automatically closes after shutdown.

ON – normal position when APU is running.

START (momentary) – positioning APU switch from OFF to START and releasing it to ON, initiates an automatic start sequence.

Intentionally
Blank



Introduction

The airplane is powered by two CFM56-7 engines. The engine is a dual-rotor, axial-flow turbofan. The N1 rotor consists of a fan, a low-pressure compressor and a low-pressure turbine. The N2 rotor consists of a high-pressure compressor and a high-pressure turbine. The N1 and N2 rotors are mechanically independent. The N2 rotor drives the engine gearboxes. A bleed-air-powered starter motor is connected to the N2 rotor.

A dual-channel electronic engine control (EEC) regulates each engine. The EEC monitors autothrottle and flight crew inputs to automatically set engine thrust.

Each engine has individual flight deck controls. Thrust is set by positioning the thrust levers. The thrust levers are positioned automatically by the autothrottle system or manually by the flight crew. The forward thrust levers control forward thrust from idle to maximum. If the EECs are in the alternate mode, advancing the thrust levers full forward provides some overboost and should be considered only during emergency situations when all other available actions have been taken and terrain contact is imminent. The reverse thrust levers control thrust from reverse idle to maximum reverse

Engine Indications

YA371, YA372, YC201

Engine indications are displayed on the center instrument panel upper display unit (DU). If a failure is detected on the upper DU, the engine indications automatically shift to the lower DU. The engine indications can also be manually selected to either the Captain's or First Officer's inboard DU, or the lower DU, using the respective display select panel.

N1, EGT, N2, and FF/FU are the primary indications and are displayed as both digital readouts and round dial/moving pointer indications. N1, EGT, and N2 have operating limits indicated by redlines. EGT also displays an amber caution limit. If one of these indications exceeds the red or amber line, the digital readout, box, pointer, and indicator change color to red or amber.

Oil pressure, oil temperature, oil quantity, and engine vibration are the secondary engine indications. Oil pressure and oil temperature indications are displayed with a round dial/moving pointer. Operating and caution ranges are displayed with red and amber lines. If the red or amber line is reached, the pointer changes color to red or amber for that indication. The oil quantity indicator displays a digital readout of quantity as a percent of full.

Engine vibration indications are displayed with a round dial/moving pointer.

The EEC must receive electrical power to supply engine operating data to the flight deck engine indications. When the EEC is not powered, N1, N2, oil quantity and engine vibration are displayed directly from the engine sensors. Positioning the engine start switch to GRD supplies electrical power to the EEC and displays pointers/digits for all engine parameters.

During battery start with no power on the airplane, only N1, N2, and oil quantity are available. The EEC is not powered until the engine accelerates to a speed greater than 15% N2. At 15% N2, the EEC becomes energized and pointers/digits for all engine parameters are displayed.

An engine failure alert indication (ENG FAIL) is displayed in amber on the EGT indicator when the respective engine is operating at a condition below sustainable idle (50% N2) and the engine start lever is in the IDLE position. The alert remains until the engine recovers, the engine start lever is moved to CUTOFF, or the engine fire warning switch is pulled.

Engine Indications

YA373 - YA377, YC202 - YE326

Primary and secondary engine indications are provided. Engine indications are displayed on the center forward panel upper display unit (DU), lower DU or the Captain's or First Officer's inboard DU.

Primary Engine Indications

N1 and EGT are the primary engine indications. The primary engine indications are normally displayed on the center forward panel upper DU. If that unit fails, the display automatically moves to the lower DU. The primary engine indications can also be manually selected to either the Captain's or First Officer's inboard DU, or the lower DU, using the respective display select panel.

Secondary Engine Indications

N2, fuel flow, oil pressure, oil temperature, oil quantity, and engine vibration are the secondary engine indications. The secondary engine indications, except for fuel flow, are manually selected to either the Captain's or First Officer's inboard DU, or the lower DU, using the respective display select panel and the ENG switch on the engine display control panel. Fuel flow is displayed full time on the upper display unit below the primary engine indications.

The secondary engine indications are automatically displayed when:

- the displays initially receive electrical power
- in flight when an engine start lever is moved to CUTOFF

- in flight when an engine N2 RPM is below idle
- a secondary engine parameter is exceeded.

When the secondary engine indications are automatically displayed, they cannot be cleared until the condition is no longer present.

Normal Display Format

N1, EGT, and N2 are displayed as both digital readouts and round dial/moving pointer indications. The digital readouts display numerical values while the moving pointers indicate relative value.

Oil pressure, oil temperature, and engine vibration indications are both digital readouts and vertical indication/moving pointers. Fuel flow and oil quantity are digital readouts only. All digital readouts are enclosed by boxes.

The dials and vertical indications display the normal operating range, caution range, and operating limits.

Normal operating range is displayed on a dial or vertical indication in white.

N1, EGT, and N2 have operating limits indicated by redlines. EGT also displays an amber caution limit. If one of these indications exceeds the red or amber line, the digital readout, box, pointer, and indicator change color to red or amber.

The oil temperature and oil pressure vertical indications have a caution range and an operating limit redline. If the oil temperature or pressure reaches the caution range, the digital readout, digital readout box, and pointer all change color to amber. If one of these indications reach the operating limit, the digital readout, digital readout box, and pointer all change color to red.

The EEC must receive electrical power to supply engine operating data to the flight deck engine indications. When the EEC is not powered, N1, N2, oil quantity and engine vibration are displayed directly from the engine sensors. Positioning the engine start switch to GRD supplies electrical power to the EEC and displays pointers/digits for all engine parameters.

During battery start with no power on the airplane, only N1, N2, and oil quantity are available. The EEC is not powered until the engine accelerates to a speed greater than 15% N2. At 15% N2, the EEC becomes energized and pointers/digits for all engine parameters are displayed.

An engine failure alert indication (ENG FAIL) is displayed in amber on the EGT indicator when the respective engine is operating at a condition below sustainable idle (50% N2) and the engine start lever is in the IDLE position. The alert remains until the engine recovers, the engine start lever is moved to CUTOFF, or the engine fire warning switch is pulled.

Compact Display

In compact format, the primary and secondary engine indications are combined on the same display. The N1 and EGT indications are displayed as they are normally. All other indications change to digital readouts only. N2, oil temperature, and oil pressure digital readouts turn red or amber if an exceedance occurs. The N2 digital display is framed with a red box after engine shutdown on the ground if an inflight exceedance occurred.

Primary and secondary engine indications are displayed in compact format on the upper DU when the secondary engine indications are selected for display (manually or automatically) and the lower DU is unavailable. Alternatively, the compacted indications are displayed on the lower DU if the upper DU is unavailable.

Electronic Engine Control (EEC)

Each engine has a full authority digital EEC. Each EEC has two independent control channels, with automatic channel transfer if the operating channel fails. With each engine start or start attempt, the EEC alternates between control channels. The EEC uses thrust lever inputs to automatically control forward and reverse thrust. N1 is used by the EEC to set thrust in two control modes: normal and alternate. Manual selection of the control mode can be made with the EEC switches on engine panel.

EEC Normal Mode

In the normal mode, the EEC uses sensed flight conditions and bleed air demand to calculate N1 thrust ratings. The EEC compares commanded N1 to actual N1 and adjusts fuel flow to achieve the commanded N1.

The full rated takeoff thrust for the installed engine is available at a thrust lever position less than the forward stop. Fixed or assumed temperature derated takeoff thrust ratings are set at thrust lever positions less than full rated takeoff. The maximum rated thrust is available at the forward stop. The EEC limits the maximum thrust according to the airplane model as follows:

- 737-600 – CFM56-7B22 rating
- 737-700 – CFM56-7B24 rating
- 737-800 – CFM56-7B27 rating

EEC Alternate Mode

The EEC can operate in either of two alternate modes, soft or hard. If required signals are not available to operate in the normal mode, the EEC automatically changes to the soft alternate mode. When this occurs, the ALTN switch illuminates and the ON indication remains visible. In the soft alternate mode, the EEC uses the last valid flight conditions to define engine parameters which allows the mode change to occur with no immediate change in engine thrust. Thrust rating shortfalls or exceedances may occur as flight conditions change. The soft alternate mode remains until the hard alternate mode is entered by either retarding the thrust lever to idle or manually selecting ALTN with the EEC switch on the aft overhead panel.

Note: Loss of either DEU results in a loss of signal to both EECs. The EEC ALTN lights illuminate and each EEC reverts to the alternate mode to prevent the engines from operating on a single source of data.

When the hard alternate mode is entered, the EEC reverts to the alternate mode thrust schedule. Hard alternate mode thrust is always equal to or greater than normal mode thrust for the same lever position. If the hard alternate mode is entered by reducing the thrust lever to idle while in the soft alternate mode, the ALTN switch remains illuminated and the ON indication remains visible. When ALTN is selected manually, the ON indication is blanked.

Structural Limit Protection

The EEC provides N1 and N2 redline overspeed protection in both normal and alternate modes. The EGT limit must be observed by the crew because the EEC does not provide EGT redline exceedance protection.

Idle Operation

The EEC automatically selects ground minimum idle, flight minimum idle, and approach idle. Ground minimum idle is selected for ground operations and flight minimum idle is selected for most phases of flight. Approach idle is selected in flight if flaps are in landing configuration or engine anti-ice is ON for either engine. At the same airspeed and altitude, N1 and N2% RPM will be higher for approach idle than for flight minimum idle. This higher% RPM improves engine acceleration time in the event of a go-around. Approach idle is maintained until after touchdown, when ground minimum idle is selected. In flight, if a fault prevents the EEC from receiving flap or anti-ice signals, approach idle schedule begins below 15,000 feet MSL.

Power Plant Schematic

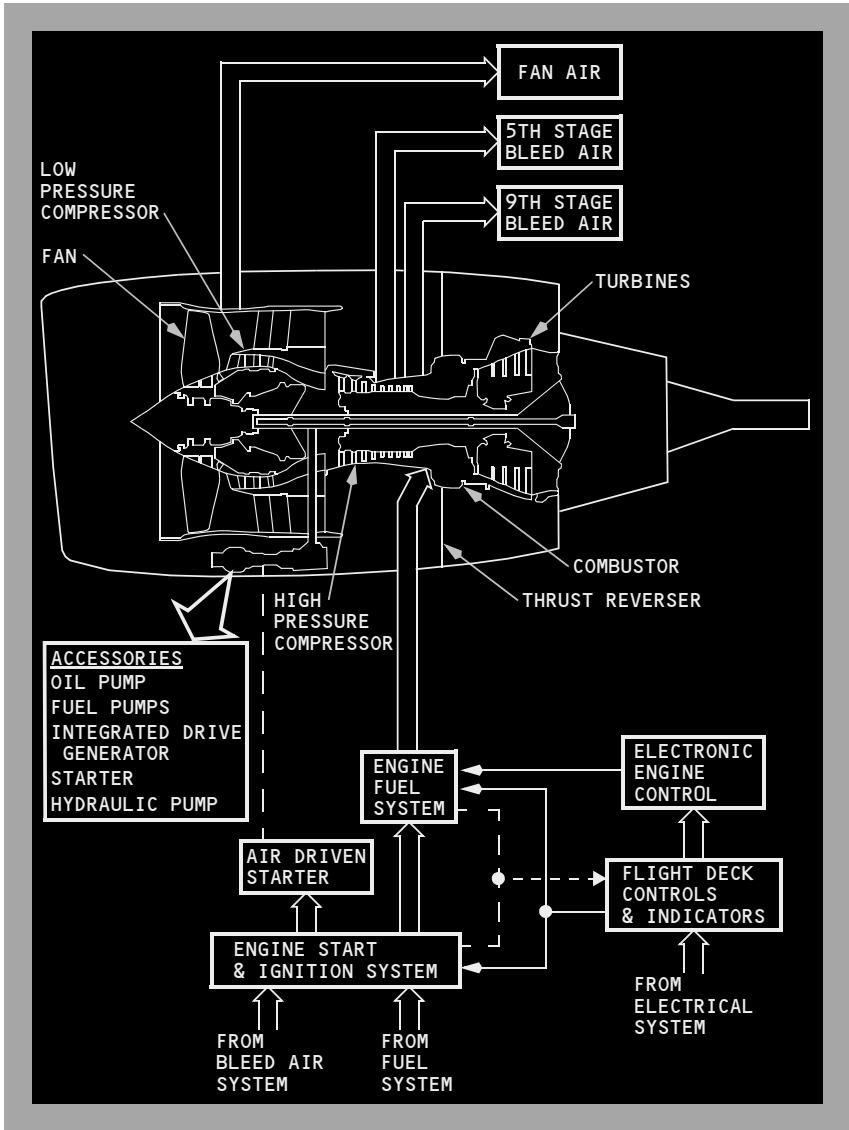

Engine Fuel System

Fuel is delivered under pressure from fuel pumps located in the fuel tanks. The fuel flows through a fuel spar shutoff valve located at the engine mounting wing stations. The fuel passes through the first stage engine fuel pump where pressure is increased. It then passes through two fuel/oil heat exchangers where IDG oil and main engine oil heat the fuel. A fuel filter then removes contaminants. Fuel automatically bypasses the filter if the filter becomes saturated. Before the fuel bypass occurs, the fuel FILTER BYPASS alert illuminates on the fuel control panel. The second stage engine fuel pump adds more pressure before the fuel reaches the hydro mechanical unit (HMU). To meet thrust requirements, the EEC meters fuel through the HMU.

The spar fuel shutoff valve and engine fuel shutoff valve allow fuel flow to the engine when both valves are open. The valves are open when the engine fire warning switch is in and the start lever is in IDLE. Both valves close when either the start lever is in CUTOFF or the engine fire warning switch is out. SPAR VALVE CLOSED and ENG VALVE CLOSED lights located on the overhead panel indicate valve position.

Fuel flow is measured after passing through the engine fuel shutoff valve and is displayed on the display unit. Fuel flow information is also provided to the FMS.

Engine Oil System

Oil from the individual engine tank is circulated under pressure, through the engine to lubricate the engine bearings and accessory gearbox. The oil quantity indicator, oil temperature indicator, oil pressure indicator and LOW OIL PRESSURE alert are all located on the display unit.

The oil system is pressurized by the engine driven oil pump. Oil from the pump, goes to the engine bearings and gearbox. Sensors for the oil temperature indicator, oil pressure indicator and LOW OIL PRESSURE alert are located downstream of the oil pump prior to engine lubrication.

Oil is returned to the oil tank by engine driven scavenge pumps. From the scavenge pumps oil passes through a scavenge filter. If the filter becomes saturated with contaminants, oil automatically bypasses the filter. Prior to the oil bypassing the scavenge filter, the OIL FILTER BYPASS alert illuminates on the upper display unit.

Prior to returning to the oil tank, the oil passes through the main engine oil cooler where it is cooled by engine fuel to maintain proper oil temperature.

Engine Fuel and Oil System Schematic

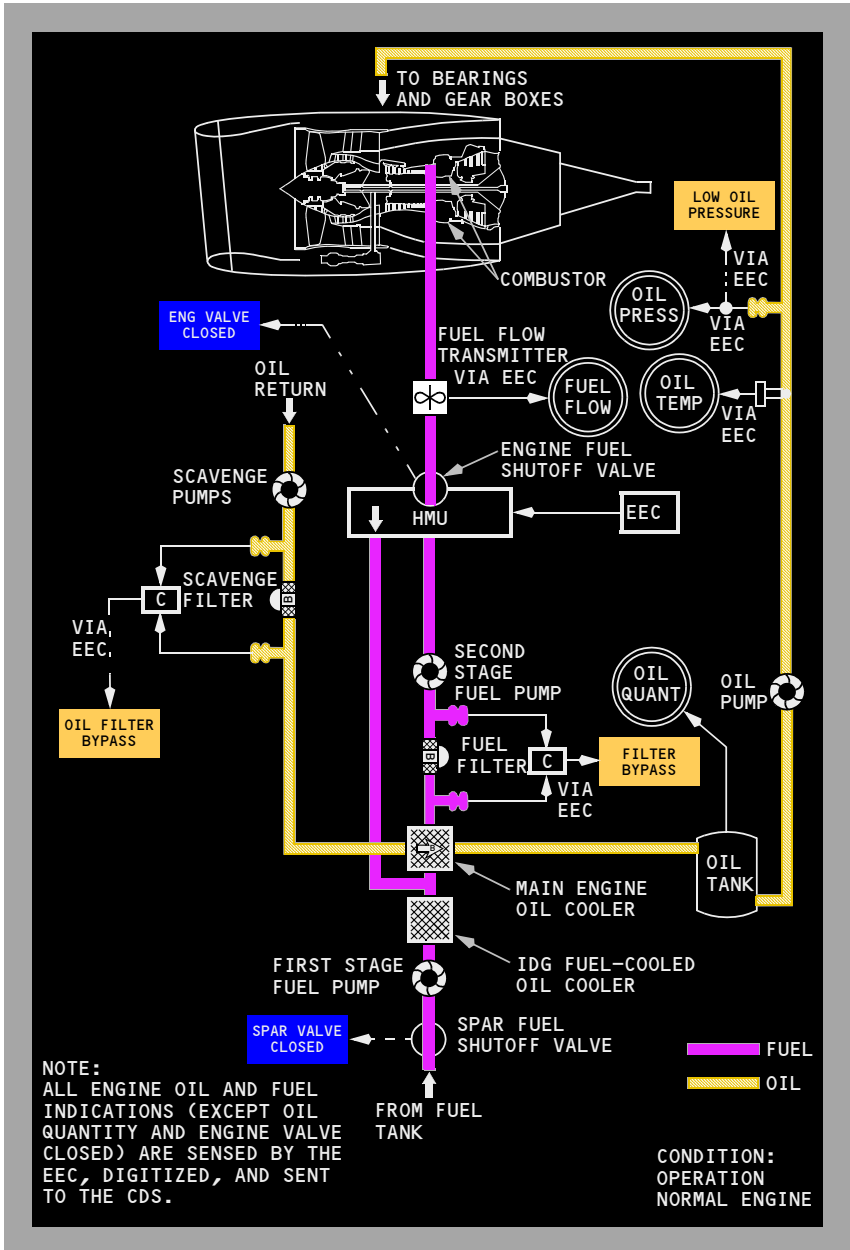

Engine Start System

Starter operation requires pressurized air and electrical power. Air from the bleed air system powers the starter motor. The APU, an external ground cart, or the other operating engine provides the bleed air source.

In the GRD position, the engine start switch uses battery power to close the engine bleed air valve and open the start valve to allow pressure to rotate the starter. When the start valve opens, an amber START VALVE OPEN alert is provided on the upper display unit. The starter rotates the N2 compressor through the accessory drive gear system. When the engine accelerates to the recommended value (25% N2 or max motoring), moving the engine start lever to the IDLE position opens the fuel valves on the wing spar and engine, and causes the EEC to supply fuel and ignition to the combustor where the fuel ignites. Initial fuel flow indications lag actual fuel flow by approximately two seconds, therefore, during engine start, an EGT rise may occur before fuel flow indication.

At starter cutout speed (approximately 56% N2), power is removed from the start switch holding solenoid. The engine start switch returns to OFF, the engine bleed air valve returns to the selected position, and the start valve closes.

Abnormal Start Protection (Ground Starts Only)

During ground starts, the EEC monitors engine parameters to detect impending hot starts, EGT start limit exceedances, and wet starts. These protection features do not function during inflight starts.

If an impending hot start is detected by a rapid rise in EGT or EGT approaching the start limit, the white box surrounding the EGT digital readout flashes. The flashing white box resets when the start lever is moved to CUTOFF or the engine reaches idle N2.

If the EGT exceeds the starting limit, the EGT display, both box and dial, turn red. The EEC automatically turns off the ignition and shuts off fuel to the engine. The alert terminates and the display returns to white when EGT drops below the start limit. Following shutdown of both engines, the EGT box turns red to remind the crew of the exceedance.

A wet start occurs if the EGT does not rise after the start lever is moved to IDLE. If a wet start is detected, the EEC turns off the ignition and shuts off fuel to the engine 15 seconds after the start lever is moved to IDLE.

Engine Ignition System

Each engine has two igniter plugs. The EEC arms the igniter plug(s) selected by the ignition select switch. The left igniter plug receives power from the associated AC transfer bus. The right igniter plug receives power from the AC standby bus.

Auto-Relight

An auto-relight capability is provided for flameout protection. Whenever the EEC detects an engine flameout, both igniters are activated. A flameout is detected when an uncommanded rapid decrease in N2 occurs, or N2 is below idle RPM.

Inflight Starting

Two methods of starting an engine inflight are available, windmill and crossbleed. None of the ground start protection features are functional during inflight start.

Note: At low N2 values, the oil scavenge pump may not provide enough pressure to return oil to the tank, causing a low oil quantity indication. Normal oil quantity should be indicated after start.

YA371, YA372, YC201

If crossbleed starting is required, the X-BLD START indication is displayed above the N2 dial. This indication is based on airplane altitude, airspeed and N2.

YA373 - YA377, YC202 - YE326

If crossbleed starting is required, the X-BLD indication (XB for the compact engine display) is displayed above the N2 dial. This indication is based on airplane altitude, airspeed and N2.

Engine Start and Ignition System Schematic

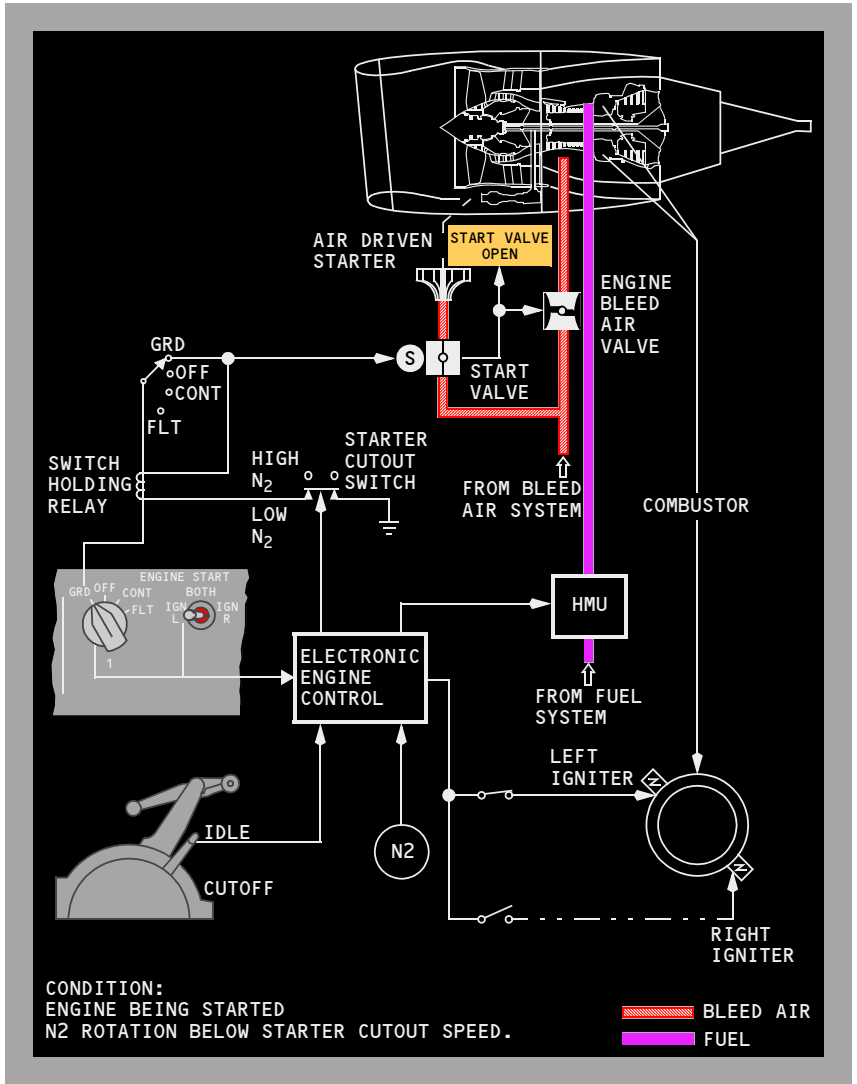

Thrust Reverser

Each engine is equipped with a hydraulically operated thrust reverser, consisting of left and right translating sleeves. Aft movement of the reverser sleeves causes blocker doors to deflect fan discharge air forward, through fixed cascade vanes, producing reverse thrust. The thrust reverser is for ground operations only and is used after touchdown to slow the airplane, reducing stopping distance and brake wear.

Hydraulic pressure for the operation of engine No. 1 and engine No. 2 thrust reversers comes from hydraulic systems A and B, respectively. If hydraulic system A and/or B fails, alternate operation for the affected thrust reverser is available through the standby hydraulic system. When the standby system is used, the affected thrust reverser deploys and retracts at a slower rate and some thrust asymmetry can be anticipated.

The thrust reverser can be deployed when either radio altimeter senses less than 10 feet altitude, or when the air/ground safety sensor is in the ground mode. Movement of the reverse thrust levers is mechanically restricted until the forward thrust levers are in the idle position.

When reverse thrust is selected, an electro-mechanical lock releases, the isolation valve opens and the thrust reverser control valve moves to the deploy position, allowing hydraulic pressure to unlock and deploy the reverser system. An interlock mechanism restricts movement of the reverse thrust lever until the reverser sleeves have approached the deployed position. When either reverser sleeve moves from the stowed position, the amber REV indication, located on the upper display unit, illuminates. As the thrust reverser reaches the deployed position, the REV indication illuminates green and the reverse thrust lever can be raised to detent No. 2. This position provides adequate reverse thrust for normal operations. When necessary, the reverse thrust lever can be pulled beyond detent No. 2, providing maximum reverse thrust.

Downward motion of the reverse thrust lever past detent No. 1 (reverse idle thrust) initiates the command to stow the reverser. When the lever reaches the full down position, the control valve moves to the stow position allowing hydraulic pressure to stow and lock the reverser sleeves. After the thrust reverser is stowed, the isolation valve closes and the electro-mechanical lock engages.

737 Flight Crew Operations Manual

The REVERSER light, located on the aft overhead panel, illuminates when the thrust reverser is commanded to stow and extinguishes 10 seconds later when the isolation valve closes. Any time the REVERSER light illuminates for more than approximately 12 seconds, a malfunction has occurred and the MASTER CAUTION and ENG system annunciator lights illuminate.

Note: A pause in movement of the reverse thrust levers past detent No. 1 toward the stow position may cause MASTER CAUTION and ENG system annunciator lights to illuminate. A pause of approximately 16 seconds engages the electro-mechanical lock and prevents the thrust reverser sleeves from further movement. Cycling the thrust reversers may clear the fault and restore normal operation.

When the reverser sleeves are in the stow position, an electro-mechanical lock and a hydraulically operated locking actuator inhibit motion to each reverser sleeve until reverser extension is selected. Additionally, an auto-restow circuit compares the actual reverser sleeve position and the commanded reverser position. In the event of incomplete stowage or uncommanded movement of the reverser sleeves toward the deployed position, the auto-restow circuit opens the isolation valve and commands the control valve to the stow position directing hydraulic pressure to stow the reverser sleeves. Once the auto-restow circuit is activated, the isolation valve remains open and the control valve is held in the stowed position until the thrust reverser is commanded to deploy or until corrective maintenance action is taken.

WARNING: Actuation of the thrust reversers on the ground without suitable precautions is dangerous to ground personnel.

Thrust Reverser Schematic

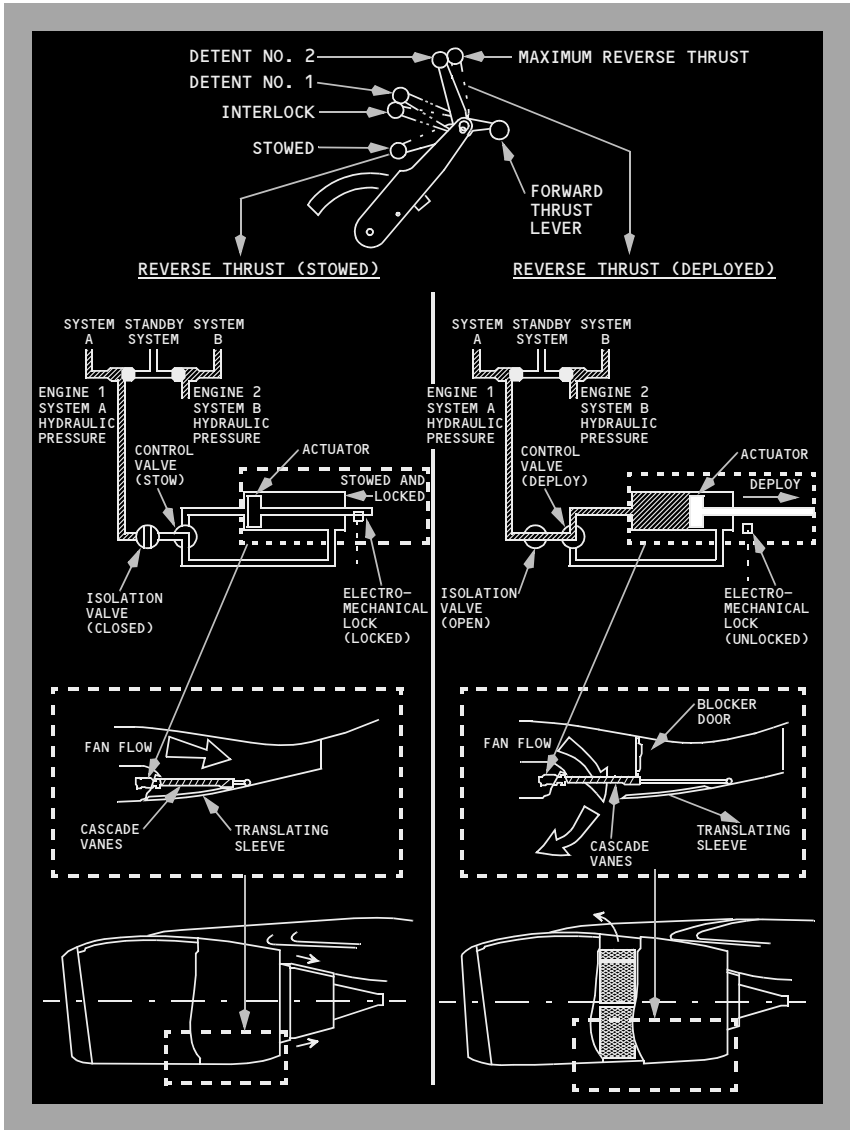

Introduction

The auxiliary power unit (APU) is a self-contained gas turbine engine installed within a fireproof compartment located in the tail of the airplane.

The APU supplies bleed air for engine starting or air conditioning. An AC electrical generator on the APU provides an auxiliary AC power source.

APU Location

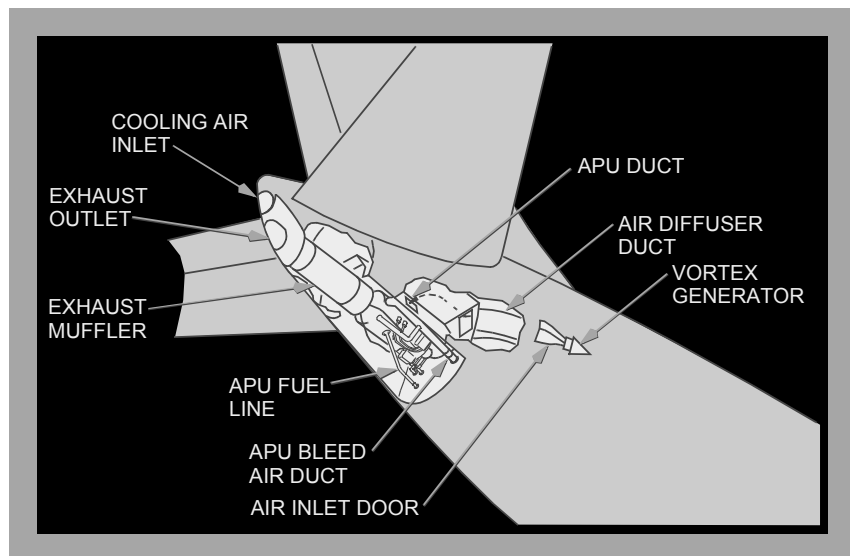

APU Operation

The APU starts and operates up to the airplane maximum certified altitude.

The APU supplies bleed air for both air conditioning packs on the ground or one pack in flight. Both transfer busses can be powered on the ground or in flight.

APU Fuel Supply

Fuel to start and operate the APU comes from the left side of the fuel manifold when the AC fuel pumps are operating. If the AC fuel pumps are not operating, fuel is suction fed from the No. 1 tank. During APU operation, fuel is automatically heated to prevent icing.

APU Engine and Cooling Air

APU engine air routes to the APU through an automatically operated air inlet door located on the right side of the fuselage. APU exhaust gases discharge overboard through an exhaust muffler.

Air for APU cooling enters through a cooling air inlet above the APU exhaust outlet. This air circulates through the APU compartment, passes through the oil cooler and vents through the exhaust outlet.

Electrical Requirements for APU Operation

APU operation requires the following:

- APU fire switch on the overheat/fire panel must be IN
- APU fire control handle on the APU ground control panel must be IN
- battery switch must be ON.

Electrical power to start the APU comes from No. 1 transfer bus or the airplane main battery. With AC power available, the starter generator uses AC power to start the APU. With no AC power, the starter generator uses battery power to start the APU.

Moving the battery switch to OFF on the ground or in the air automatically shuts down the APU because of power loss to the electronic control unit.

APU Start

The automatic start sequence begins by moving the APU switch momentarily to START. This initiates opening of the air inlet door. When the APU inlet door reaches the full open position the start sequence begins. After the APU reaches the proper speed, ignition and fuel are provided. When the APU is ready to accept a bleed air or electrical load the APU GEN OFF BUS light illuminates.

Note: When the APU is started using battery power only, there is no indication on the electrical metering panel that the APU generator has come on line and is ready to be selected. Both the frequency and voltage readings are zero until the APU generator is placed on line.

Note: During the APU start cycle, the APU EGT indication may fluctuate from 0° to 1100° C prior to normal EGT rise and the LOW OIL PRESSURE light may cycle on and off several times. These indications have no adverse effect on starting the APU. It is not necessary to monitor EGT during start.

If the APU does not reach the proper speed with the proper acceleration rate within the time limit of the starter, the start cycle automatically terminates. The start cycle may take as long as 120 seconds. Automatic shutdown occurs in the event of EGT exceedance.

737 Flight Crew Operations Manual

If the start fails or the APU GEN OFF BUS light fails to illuminate by the end of the start cycle, a system failure has occurred and the FAULT light illuminates.

Operate the APU for one full minute before using it as a bleed air source. This one minute stabilization is recommended to extend the service life of the APU.

APU Shutdown

Operate the APU for one full minute with no bleed air load prior to shutdown. This cooling period is recommended to extend the service life of the APU. When the APU switch is moved to OFF, this time delay is met automatically.

Moving the APU switch to OFF trips the APU generator, closes the APU bleed air valve and extinguishes the APU GEN OFF BUS light. Shutdown occurs automatically after 60 seconds. When the APU speed decreases sufficiently during shutdown, the fuel valve and inlet door close. If the fuel valve does not close, the FAULT light will illuminate after approximately 30 seconds. An immediate shutdown can be accomplished by pulling the APU fire switch.

Electronic Control Unit (ECU)

An electronic control unit (ECU) monitors and controls the APU. Automatic shutdown protection is provided for overspeed conditions, low oil pressure, high oil temperature, APU fire, fuel control unit failure, EGT exceedance, and other system faults monitored by the ECU.

The ECU automatically controls APU speed through the electronic fuel control. If speed or EGT exceed acceptable levels with the APU providing electrical load only, some electrical load is shed. When electrical load and air extraction raise the EGT above acceptable levels during engine starting, electrical load shedding occurs prior to reducing bleed air. When electrical load and air extraction raise the EGT above acceptable levels other than during engine starting, the inlet guide vanes move toward a closed position, reducing bleed air extraction while maintaining electrical load.

APU Automatic Load Shedding

In flight, if the APU is the only source of electrical power, all galley busses and main busses are automatically shed. If electrical load still exceeds design limits, both IFE busses are also automatically shed. On the ground, the APU attempts to carry a full electrical load. If an overload condition is sensed, the APU sheds galley busses and main busses until the load is within limits. Manual restoration of galley and main bus power can be attempted by moving the CAB/UTIL Power Switch to OFF, then back ON.

Intentionally
Blank



Fire Protection
Table of Contents

Chapter 8
Section 0

Controls and Indicators 8.10.1

- Overheat/Fire Protection Panel Switches 8.10.1
- Overheat/Fire Protection Panel Lights 8.10.3
- Cargo Fire Panel 8.10.4
- Master Fire Warning Light 8.10.6
- APU Ground Control Panel 8.10.7
- Lavatory Fire 8.10.8

System Description 8.20.1

- Introduction 8.20.1
- Engine Fire Protection 8.20.1
 - Engine Overheat and Fire Detection 8.20.1
 - Engine Fire Extinguishing 8.20.2
 - Engine Fire Extinguisher Schematic 8.20.3
- APU Fire Protection 8.20.4
 - APU Fire Detection 8.20.4
 - APU Fire Extinguishing 8.20.4
- Main Wheel Well Fire Protection 8.20.5
 - Main Wheel Well Fire Detection 8.20.5
- Cargo Compartment Fire Protection 8.20.5
 - Cargo Compartment Smoke Detection 8.20.5
 - Cargo Compartment Fire Warning 8.20.5
 - Cargo Compartment Fire Extinguishing 8.20.6
 - Cargo Fire Extinguisher Schematic 8.20.6
- Lavatory Fire Protection 8.20.7
 - Lavatory Smoke Detection 8.20.7
 - Lavatory Fire Extinguisher System 8.20.7
- Fire and Overheat System Tests 8.20.7
 - FAULT/INOP Test Detection 8.20.7
 - OVERHEAT/FIRE Test Detection 8.20.7



737 Flight Crew Operations Manual

Extinguisher Test	8.20.8
Cargo Fire System Tests	8.20.8
Cargo Fire TEST	8.20.8
Cargo Fire Extinguisher Test	8.20.9

Overheat/Fire Protection Panel Switches

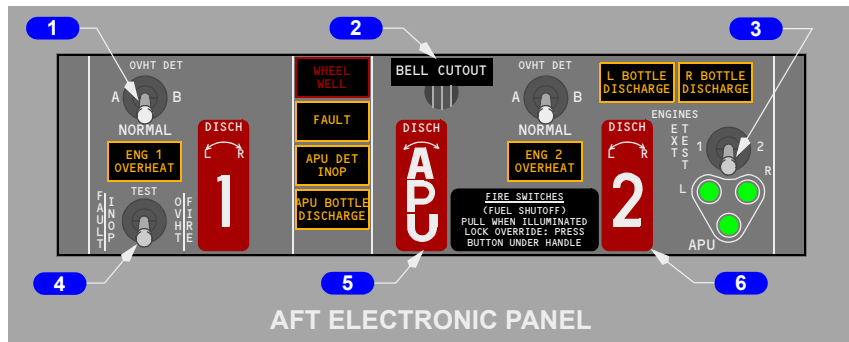

1 Overheat Detector (OVHT DET) Switch

NORMAL – detection loop A and loop B are active.

A – detection loop A is active.

B – detection loop B is active.

2 Fire Warning BELL CUTOUT Switch

Push –

- extinguishes both master FIRE WARN lights
- silences the fire warning bell
- silences the remote APU fire warning horn (on the ground only)
- resets the system for additional warnings.

3 Extinguisher (EXT) TEST Switch

(spring-loaded to center)

1 or 2 – tests bottle discharge circuits for all three extinguisher bottles.

4 Fault/Inoperative (FAULT/INOP) and Overheat/Fire (OVHT/FIRE) TEST Switch

(spring-loaded to center)

FAULT/INOP – tests fault detection circuits for both engines and the APU.

OVHT/FIRE – tests overheat and fire detection loops on both engines and APU, and wheel well fire detector

Note: See Fire and Overheat Detection System Fault Test in Section 20.

5 APU Fire Warning Switch

Illuminated (red) –

- indicates fire in APU
- unlocks APU fire warning switch.

Note: Master FIRE WARN lights illuminate, fire warning bell sounds, and in the main wheel well the APU fire warning horn sounds (on ground only), and APU fire warning light flashes.

In – normal position, mechanically locked if no fire signal.

Up –

- arms APU extinguisher circuit
- closes fuel shutoff valve, APU bleed air valve, and APU inlet door
- trips generator control relay and breaker
- allows APU fire warning switch to rotate.

Rotate (left or right) –

- discharges APU fire bottle.

6 Engine Fire Warning Switch

Illuminated (red) –

- indicates fire in related engine
- unlocks related engine fire warning switch.

Note: Master FIRE WARN lights illuminate and fire warning bell sounds.

In – normal position, mechanically locked if no fire signal.

Up –

- arms one discharge squib on each engine fire extinguisher
- closes fuel, hydraulic shutoff and engine bleed air valves
- disables thrust reverser
- trips generator control relay and breaker
- deactivates engine driven hydraulic pump LOW PRESSURE light
- allows engine fire warning switch to rotate.

Rotate (left or right) – discharges related fire bottle.

Fire Warning Switch Override

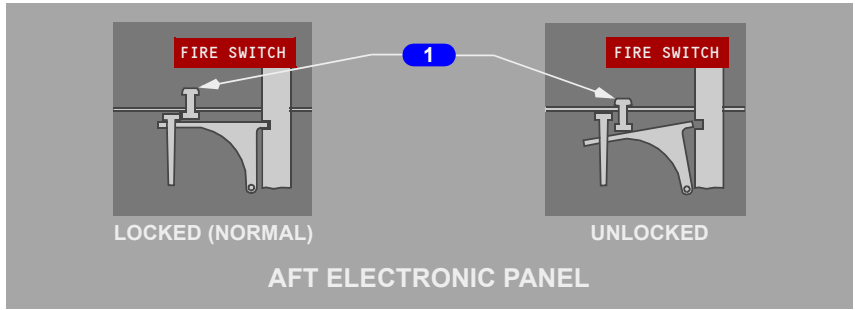

1 Fire Warning Switch Override

Push – unlocks fire warning switch.

Overheat/Fire Protection Panel Lights

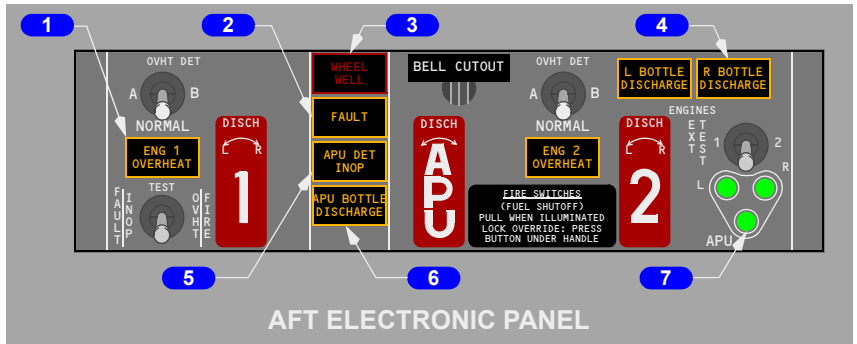

1 Engine (ENG) OVERHEAT Light

Illuminated (amber) – indicates overheat in related engine.

Note: MASTER CAUTION and OVHT/DET system annunciator lights illuminate.

2 FAULT Light

Illuminated (amber) – with the overheat detector switch in NORMAL - indicates both detector loops for an engine have failed.

Illuminated (amber) – with the overheat detector switch in A or B – indicates the selected loop for an engine has failed.

Note: MASTER CAUTION and OVHT/DET system annunciator lights do not illuminate.

3 WHEEL WELL Fire Warning Light

Illuminated (red) – indicates fire in main gear wheel well

Note: Master FIRE WARN lights illuminate and fire warning bell sounds.

4 Engine BOTTLE DISCHARGE Light

Illuminated (amber) – indicates related fire extinguisher bottle has discharged.

5 APU Detector Inoperative (DET INOP) Light

Illuminated (amber) – indicates APU detector loop has failed.

Note: MASTER CAUTION and OVHT/DET system annunciator lights illuminate.

6 APU BOTTLE DISCHARGE Light

Illuminated (amber) – indicates APU extinguisher bottle has discharged.

7 Extinguisher Test (EXT TEST) Lights

Illuminated (green) – EXT TEST switch is positioned to 1 or 2 and circuit continuity is normal.

Cargo Fire Panel

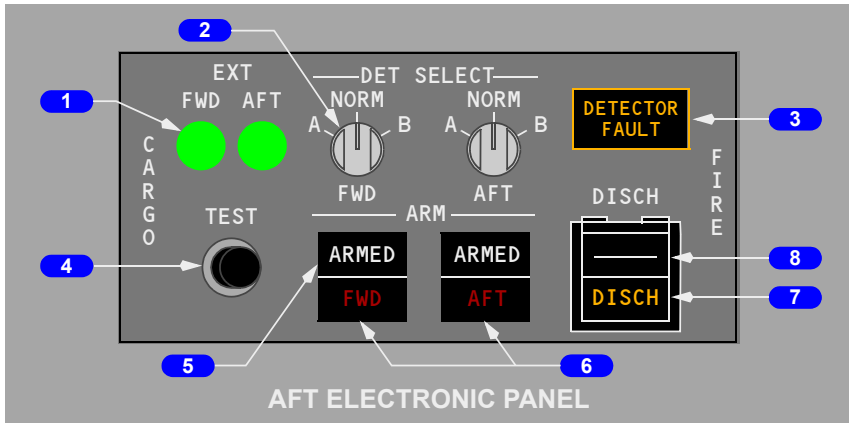

1 Extinguisher (EXT) Test Lights

Illuminated (green) - Cargo Fire TEST switch is pushed and fire bottle discharge squib circuit continuity is normal.

2 Detector Select (DET SELECT) Switches

NORM - detection loop A and B are active.

A - detection loop A is active.

B - detection loop B is active.

3 DETECTOR FAULT Light

Illuminated (amber) -

- Both loops in one or both cargo compartments have failed

4 Cargo Fire TEST Switch

PUSH - tests circuits for both forward and aft cargo fire detector loops and suppression system.

Note: See Cargo Fire System Tests in Section 20.

5 Cargo Fire ARM Switches

PUSH -

- FWD ARMED - extinguisher armed for the forward cargo compartment
- AFT ARMED - extinguisher armed for the aft cargo compartment.

Note: If the first bottle has discharged and the system remains armed, the second bottle discharge is inhibited upon landing. The second bottle discharge timer is disabled when the system is disarmed.

6 Cargo Fire (FWD/AFT) Warning Lights

Illuminated (red) -

- at least one detector in each loop detects smoke
- with power failed in one loop, at least one detector on the remaining loop detects smoke.

Note: Master FIRE WARN lights illuminate and fire warning bell sounds.

7 Cargo Fire Bottle Discharge (DISCH) Light

Illuminated (amber) - indicates that either extinguisher bottle has discharged

8 Cargo Fire Discharge (DISCH) Switch

PUSH - if system is armed, discharges the first extinguisher bottle. The timer is set for 60 minutes to discharge the second extinguisher bottle.

Master Fire Warning Light

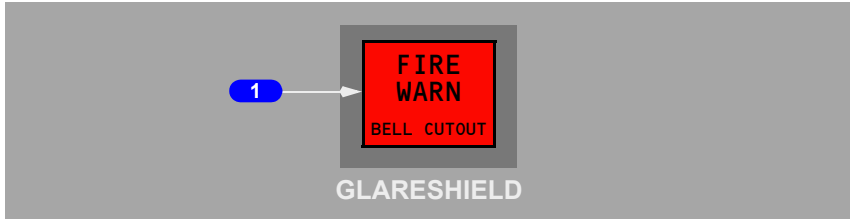

1 Master Fire Warning (FIRE WARN) Lights

Illuminated (red) – indicates a fire warning (or system test) in engine, APU, main gear wheel well or cargo compartment

- fire warning bell sounds
- if on ground, remote APU fire warning horn sounds.

Push –

- extinguishes both master FIRE WARN lights
- silences fire warning bell
- silences remote APU fire warning horn
- resets system for additional warnings.

Note: Pushing fire warning bell cutout switch on overheat/fire protection panel results in same actions.

APU Ground Control Panel

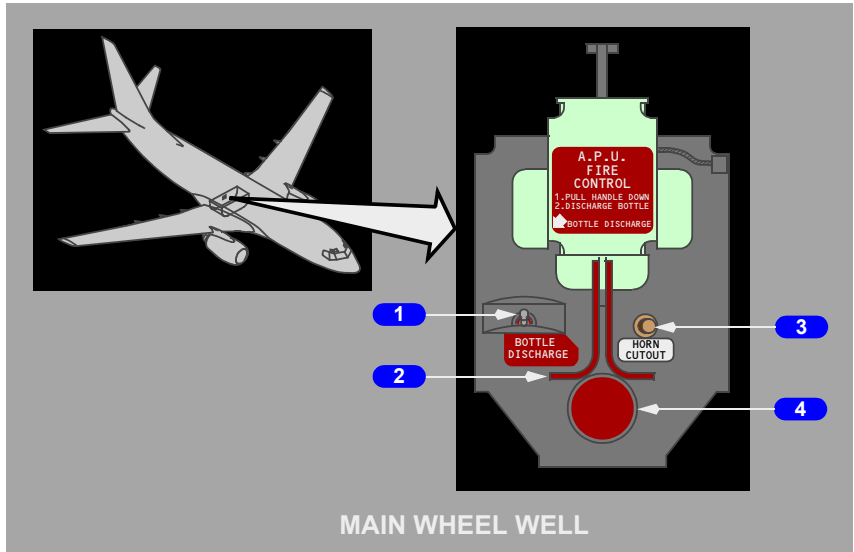

1 APU BOTTLE DISCHARGE Switch

(spring-loaded to the right and safety wired.)

Left – discharges APU extinguisher.

Note: Armed only if APU fire control handle is pulled at this panel.

2 APU Fire Control Handle

Up – normal position.

Down –

- arms APU BOTTLE DISCHARGE switch (on this panel only)
- closes APU fuel shutoff, bleed air valve and APU inlet door
- trips generator control relay and breaker.

3 APU Fire Warning HORN CUTOUT Switch

Push –

- silences fire alarm bell
- silences APU fire warning horn
- causes APU fire warning light to stop flashing but remain illuminated.

4 APU Fire Warning Light

Illuminated (red flashing) – indicates fire in APU.

Note: Also, flight deck fire warning bell sounds and APU fire warning horn in main wheel well sounds.

Illuminated (red steady) – indicates APU fire warning HORN CUTOUT switch has been pushed following an APU fire indication.

Lavatory Fire

Lavatory Fire Extinguisher

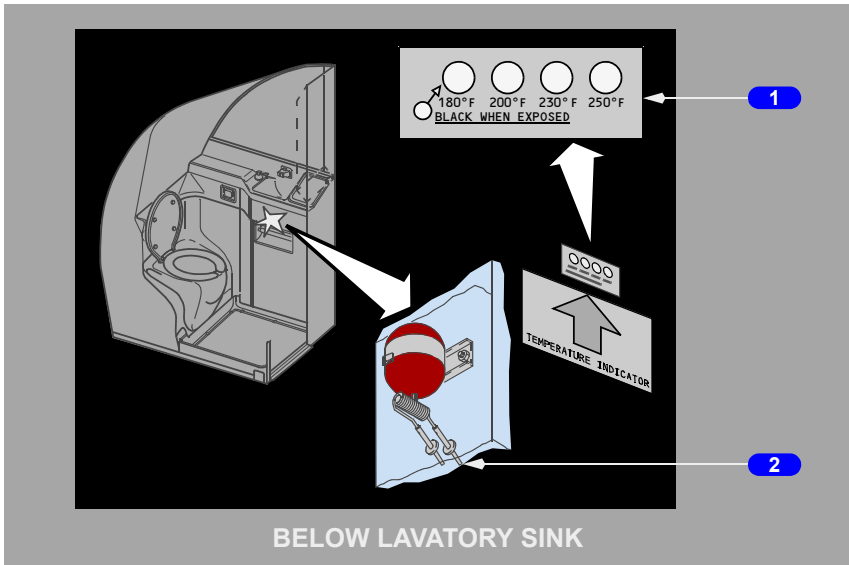

1 TEMPERATURE INDICATOR Placard

White – normal condition.

Black – exposed to high temperatures.

2 Heat Activated Nozzles

Flat black – normal condition.

Aluminum – indicates extinguisher has discharged.

Introduction

There are fire detection and extinguishing systems for:

- engines
- lavatories
- APU
- cargo compartments.

The engines also have overheat detection systems.

The main gear wheel well has a fire detection system, but no fire extinguishing system.

Engine Fire Protection

Engine fire protection consists of these systems:

- engine overheat and fire detection powered by the battery bus
- engine fire extinguishing powered by the hot battery bus.

Engine Overheat and Fire Detection

Each engine contains two overheat/fire detector loops. Each loop provides both fire and overheat detection. As the temperature of a detector increases to a predetermined limit, the detector senses an overheat condition. At higher temperatures, the detector senses a fire condition. Normally, both detector loops must sense a fire or overheat condition to cause an engine overheat or fire alert. The ENG OVERHEAT light or engine fire warning switch remains illuminated until the temperature drops below the onset temperature.

An OVHT DET switch for each engine, labeled A, B, and NORMAL, permits selection of either loop A or B, or both A and B, as the active detecting loops.

The system contains a fault monitoring circuit. If one loop fails with the OVHT DET switch in NORMAL, that loop is automatically deselected and the remaining loop functions as a single loop detector. There is no flight deck indication of single loop failure. If both loops fail on an engine, the FAULT light illuminates and the system is inoperative.

If the OVHT DET switch is positioned to A or B, the system operates as a single loop system. The non-selected loop is not monitored. If the selected loop fails, the FAULT light illuminates and the system is inoperative.

The indications of an engine overheat are:

- both MASTER CAUTION lights illuminate
- the OVHT/DET system annunciator light illuminates
- the related ENG OVERHEAT light illuminates.

The indications of an engine fire are:

- the fire warning bell sounds
- both master FIRE WARN lights illuminate
- the related engine fire warning switch illuminates
- all related engine overheat alert indications illuminate.

Engine Fire Extinguishing

The engine fire extinguisher system consists of two engine fire extinguisher bottles, two engine fire warning switches, two BOTTLE DISCHARGE lights, and an EXT TEST switch. Either or both bottles can be discharged into either engine.

The engine fire warning switches are normally locked down to prevent inadvertent shutdown of an engine. Illumination of an engine fire warning switch or ENG OVERHEAT light unlocks the engine fire warning switch. The switches may also be unlocked manually.

Pulling the engine fire warning switch up:

- closes both the engine fuel shutoff valve and the spar fuel shutoff valve
- closes the engine bleed air valve resulting in loss of wing anti-ice to the affected wing and closure of bleed air operated pack valve
- trips the generator control relay and breaker
- closes the hydraulic fluid shutoff valve. The engine driven hydraulic pump LOW PRESSURE light is deactivated
- disables thrust reverser for the related engine.
- allows the engine fire warning switch to be rotated for discharge
- arms one discharge squib on each engine fire extinguisher bottle.

Rotating the engine fire warning switch electrically “fires” a squib, discharging the extinguishing agent into the related engine. Rotating the switch the other way discharges the remaining bottle.

The L or R BOTTLE DISCHARGE light illuminates a few seconds after the engine fire warning switch is rotated, indicating the bottle has discharged.

Engine Fire Extinguisher Schematic

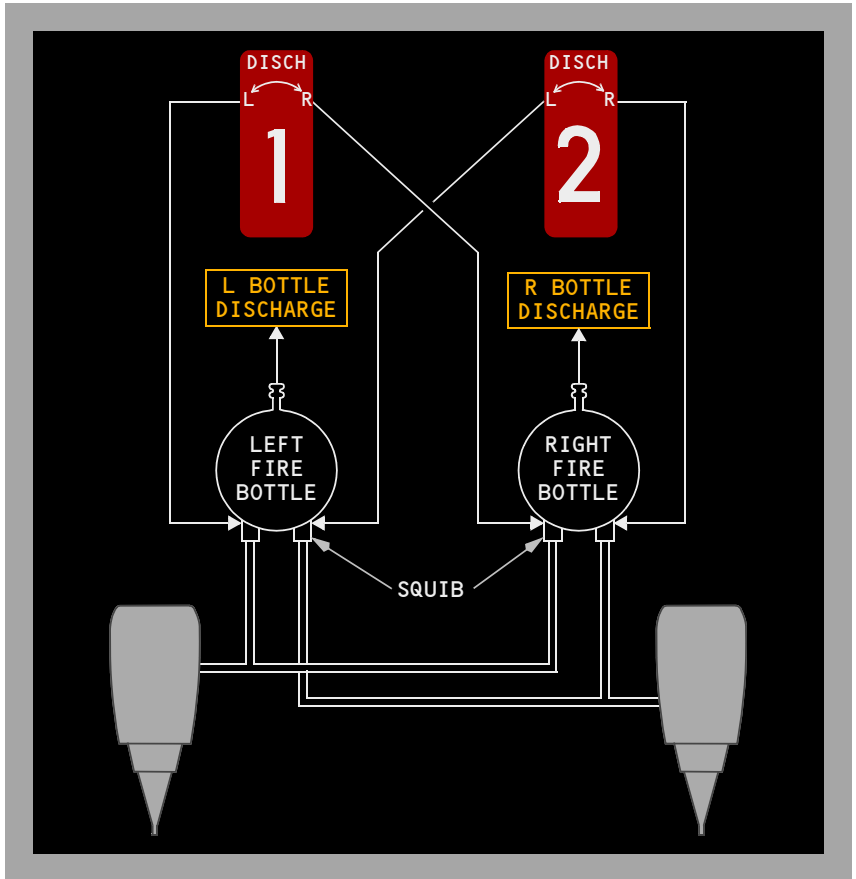

APU Fire Protection

APU fire protection consists of these systems:

- APU fire detection powered by the battery bus.
- APU fire extinguishing powered by the hot battery bus.

APU Fire Detection

A single fire detection loop is installed on the APU. As the temperature of the detector increases to a predetermined limit, the detector senses a fire condition. The APU fire warning switch remains illuminated until the temperature of the detector has decreased below the onset temperature.

The system contains a fault monitoring circuit. If the loop fails, the APU DET INOP light illuminates indicating the APU fire detection system is inoperative.

The indications of an APU fire are:

- the fire warning bell sounds
- both master FIRE WARN lights illuminate
- the APU fire warning switch illuminates
- the APU automatically shuts down
- the wheel well APU fire warning horn sounds, (on the ground only), and the wheel well APU fire warning light flashes.

APU Fire Extinguishing

The APU fire extinguisher system consists of one APU fire extinguisher bottle, an APU fire warning switch, an APU BOTTLE DISCHARGE light, and an EXT TEST switch. The APU ground control panel located in the right main wheel well also contains an APU fire warning light, an APU BOTTLE DISCHARGE switch, an APU fire control handle and APU HORN CUTOFF switch.

The APU fire warning switch is normally locked down to prevent inadvertent shutdown of the APU. Illumination of the APU fire warning switch unlocks the switch. The switch may also be unlocked manually.

Pulling the APU Fire Warning switch up:

- provides backup for the automatic shutdown feature
- deactivates the fuel solenoid and closes the APU fuel shutoff valve
- closes the APU bleed air valve
- closes the APU air inlet door
- trips the APU generator control relay and breaker
- allows the APU fire warning switch to be rotated for discharge
- arms the APU fire extinguisher bottle squib.

737 Flight Crew Operations Manual

Rotating the APU fire warning switch in either direction electrically “fires” the squib discharging the extinguishing agent into the APU. The APU BOTTLE DISCHARGE light illuminates after a few seconds, indicating the bottle has discharged.

Main Wheel Well Fire Protection

Main wheel well fire protection consists of fire detection powered by the No. 1 AC transfer bus.

Note: The main wheel well has no fire extinguishing system. The nose wheel well does not have a fire detection system.

Main Wheel Well Fire Detection

A single fire detector loop is installed in the main wheel well. As the temperature of the detector increases to a predetermined limit, the detector senses a fire condition. The WHEEL WELL fire warning light remains illuminated until the temperature of the detector has decreased below the onset temperature.

The indications for a main wheel well fire are:

- the fire warning bell sounds
- both master FIRE WARN lights illuminate
- the WHEEL WELL fire warning light illuminates.

Cargo Compartment Fire Protection

Cargo fire protection consists of these systems:

- cargo compartment smoke detection powered by DC bus 1 and DC bus 2
- cargo compartment fire extinguishing powered by the hot battery bus.

Cargo Compartment Smoke Detection

The forward and aft cargo compartments each have smoke detectors in a dual loop configuration. Normally, both detection loops must sense smoke to cause an alert. These loops function in the same manner as the engine overheat/fire detection loops.

Cargo Compartment Fire Warning

The indications of a cargo compartment fire are:

- the fire warning bell sounds
- both master FIRE WARN lights illuminate
- the FWD/AFT cargo fire warning light(s) illuminates.

Cargo Compartment Fire Extinguishing

Two fire extinguisher bottles are installed in the air conditioning mix bay on the forward wing spar. Detection of a fire in either the forward or aft compartment will cause the FWD or AFT cargo fire warning light to illuminate. The extinguishers are armed by pushing the appropriate cargo fire ARMED switch. Once armed, the first bottle is discharged by pushing the cargo fire DISCH switch. This results in the total discharge of the first bottle contents into the selected compartment. The second bottle discharge is metered to discharge at a reduced flow into the selected compartment. Discharge of the second bottle may be disabled if the system is disarmed. The cargo fire DISCH light illuminates when a bottle is discharged. It may take up to 30 seconds for the light to illuminate. On landing, if the first bottle was discharged and the system remains armed, the second bottle discharge is inhibited.

Cargo Fire Extinguisher Schematic

YE321 - YE326

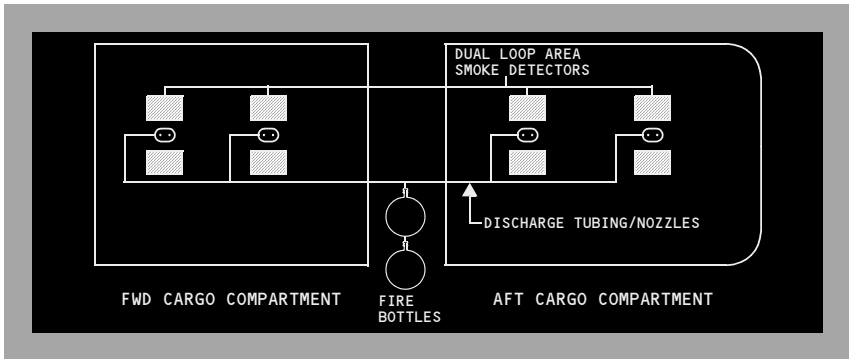

YA371 - YC207

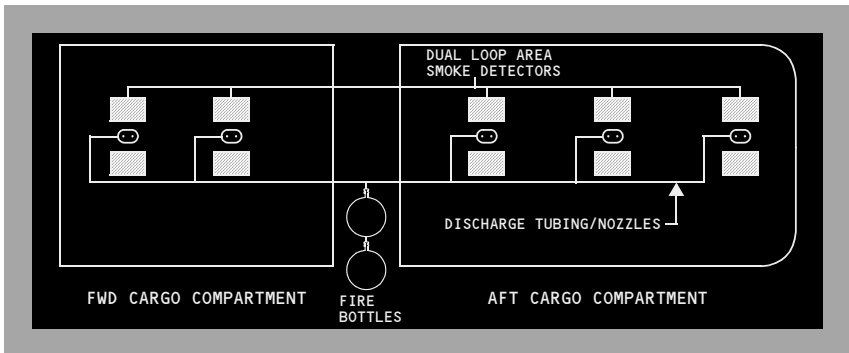

Lavatory Fire Protection

Lavatory fire protection consists of these systems:

- lavatory smoke detection
- lavatory fire extinguishing (heat activated).

Lavatory Smoke Detection

The lavatory smoke detection system monitors for the presence of smoke. When smoke is detected:

- an aural warning sounds
- the red alarm indicator light on the lavatory smoke detector panel illuminates.

There is no flight deck indication. When smoke is no longer present the system automatically resets.

Lavatory Fire Extinguisher System

A fire extinguisher system is located beneath the sink area in each lavatory. When a fire is detected:

- fire extinguisher operation is automatic
- flight deck has no indication of extinguisher discharge.

Fire and Overheat System Tests

The fire and overheat detection systems can be tested by pushing and holding the FAULT/INOP and OVHT/FIRE TEST switch. Extinguisher continuity can be tested by pushing and holding the EXT TEST switch. All test indications clear when switches are released.

FAULT/INOP Test Detection

The fault detection circuits for both the engines and the APU are tested by pushing and holding the FAULT/INOP and OVHT/FIRE TEST switch in the FAULT/INOP position.

The indications for the FAULT/INOP test are:

- both MASTER CAUTION lights illuminate
- the OVHT/DET system annunciator light illuminates
- the FAULT light illuminates
- the APU DET INOP light illuminates.

OVERHEAT/FIRE Test Detection

The overheat and fire detection loops on both engines, the APU, and the fire detector in the wheel well are tested by pushing and holding the FAULT/INOP and OVHT/FIRE TEST switch in the OVHT/FIRE position.

The indications for the OVHT/FIRE test are:

- the fire warning bell sounds
- both master FIRE WARN lights illuminate
- both MASTER CAUTION lights illuminate
- the OVHT/DET system annunciator light illuminates
- both engine fire warning switches illuminate
- the APU fire warning switch illuminates
- both ENG OVERHEAT lights illuminate
- the WHEEL WELL fire warning light illuminates if AC power is available
- on the ground, the wheel well APU fire warning horn sounds and the wheel well APU fire warning light flashes.

Extinguisher Test

When the EXT TEST switch is positioned to 1 or 2, the green EXT TEST lights illuminate, verifying circuit continuity from the squib to the engine fire warning switch.

Cargo Fire System Tests

The cargo fire detection and suppression system can be tested by pushing and holding the cargo fire TEST switch. This sends a test signal to the forward and aft cargo fire detector loops and verifies continuity of the extinguisher bottle squib circuits. All test indications clear when the TEST switch is released

Cargo Fire TEST

The indications for the Cargo Fire test are:

- the fire warning bell sounds
- both master FIRE WARN lights illuminate
- the extinguisher test lights illuminate

737 Flight Crew Operations Manual

- the FWD and AFT cargo fire warning lights illuminate when all detectors in selected loops (s) respond to the fire test
- the cargo fire bottle DISCH light illuminates

Note: The fire warning BELL CUTOFF switch on the Overheat/Fire Protection panel can silence the fire warning bell and extinguish the master FIRE WARN lights

Note: During a Cargo Fire Test, the DETECTOR Fault light will illuminate if one or more detectors in the loop(s) has failed.

Note: Individual detector faults can only be detected by a manually initiated test. The MASTER CAUTION light does not illuminate.

Note: At the end of cargo fire testing, up to a four second delay may occur to allow all applicable indications to extinguish at the same time.

Cargo Fire Extinguisher Test

When the Cargo Fire TEST button is pushed, the green EXT lights illuminate, verifying the fire bottle discharge squib circuit continuity is normal.



Intentionally
Blank



Controls and Indicators	9.10.1
Flight Control Panel	9.10.1
Stabilizer	9.10.5
Rudder	9.10.7
Aileron / Elevator / Flight Spoilers	9.10.8
Speed Brakes	9.10.9
Trailing Edge Flaps	9.10.11
Leading Edge Devices	9.10.14
System Description	9.20.1
Introduction	9.20.1
Pilot Controls	9.20.1
Flight Control Surfaces	9.20.2
Flight Control Surfaces Location	9.20.2
Roll Control	9.20.3
Ailerons	9.20.3
Flight Spoilers	9.20.4
Roll Control Schematic	9.20.5
Pitch Control	9.20.6
Elevators	9.20.6
Stabilizer	9.20.7
Pitch Control Schematic	9.20.9
Stall Identification	9.20.10
Yaw Control	9.20.11
Rudder	9.20.11
Rudder (with Rudder System Enhancement Program (RSEP) installed)	9.20.11
Yaw Damper	9.20.12
Yaw Control Schematic	9.20.14



737 Flight Crew Operations Manual

Speed Brakes	9.20.16
In-Flight Operation	9.20.16
Ground Operation	9.20.16
Speed Brakes Schematic	9.20.18
Flaps and Slats	9.20.19
Flap and Slat Sequencing	9.20.19
Flap Load Relief	9.20.19
Autoslats	9.20.20
Alternate Extension	9.20.20
Asymmetry and Skew Detection, Protection and Indication	9.20.22
Uncommanded Motion Detection, Protection and Indication	9.20.22

Flight Control Panel

YA371

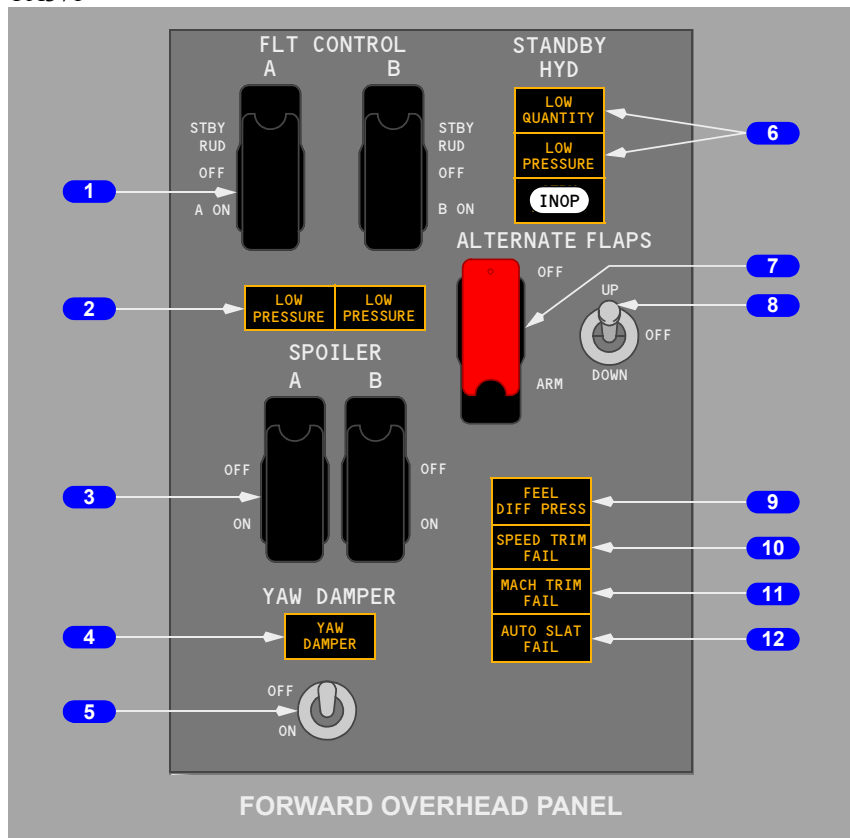

YA372 - YE326

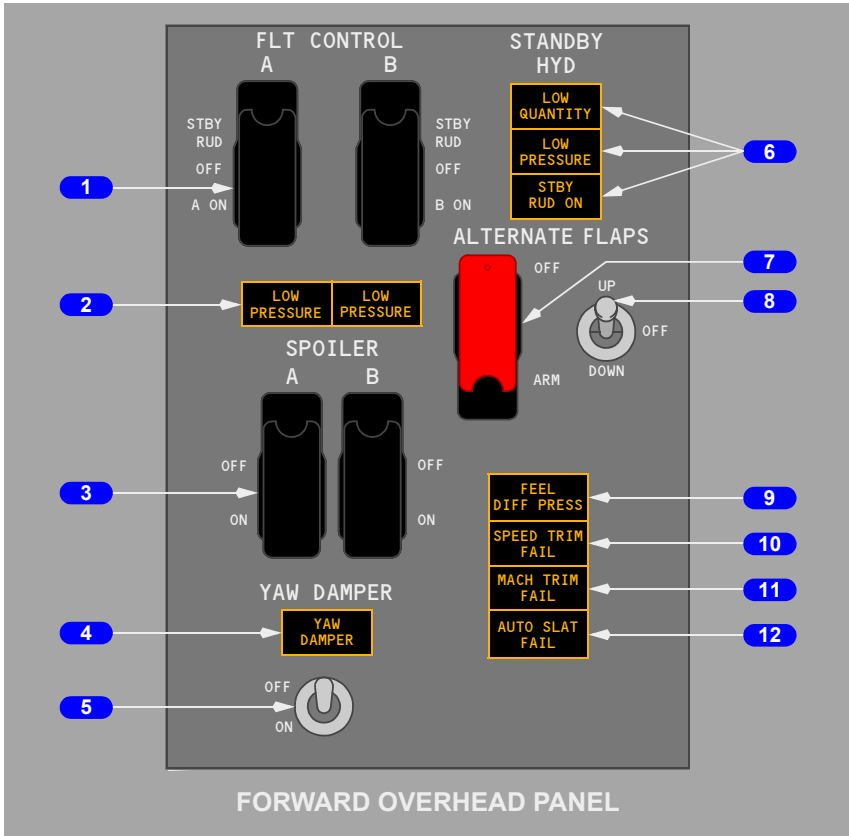

1 FLIGHT CONTROL Switches

STBY RUD - activates standby hydraulic system pump and opens standby rudder shutoff valve to pressurize standby rudder power control unit.

OFF - closes flight control shutoff valve isolating ailerons, elevators and rudder from associated hydraulic system pressure.

ON (guarded position) - normal operating position.

2 Flight Control LOW PRESSURE Lights

Illuminated (amber) -

- indicates low hydraulic system (A or B) pressure to ailerons, elevator and rudder
- deactivated when associated FLIGHT CONTROL switch is positioned to STBY RUD and standby rudder shutoff valve opens.

737 Flight Crew Operations Manual

3 Flight SPOILER Switches

ON (guarded position) – normal operating position.

OFF – closes the respective flight spoiler shutoff valve.

Note: Used for maintenance purposes only.

4 YAW DAMPER Light

Illuminated (amber) – yaw damper is not engaged.

5 YAW DAMPER Switch

OFF – disengages yaw damper.

ON –

- engages main yaw damper to main rudder power control unit if the B FLT CONTROL switch is in the ON position
- engages standby yaw damper to standby rudder power control unit if both the A and B FLT CONTROL switches are in the STBY RUD position.

6 STANDBY HYD Lights

STANDBY HYDRAULIC LOW QUANTITY Light

Illuminated (amber) -

- indicates low quantity in standby hydraulic reservoir
- always armed.

STANDBY HYDRAULIC LOW PRESSURE Light

Illuminated (amber) -

- indicates output pressure of standby pump is low
- armed only when standby pump operation has been selected or automatic standby function is activated.

YA372 - YE326

STBY RUD ON Light

- Illuminated (amber) - indicates the standby rudder system is commanded on to pressurize the standby rudder power control unit.

7 ALTERNATE FLAPS Master Switch

OFF (guarded position) – normal operating position.

ARM – closes TE flap bypass valve, activates standby pump, and arms the ALTERNATE FLAPS position switch.

8 ALTERNATE FLAPS Position Switch

Functions only when the ALTERNATE FLAPS master switch is in ARM.

UP –

- electrically retracts TE flaps
- LE devices remain extended and cannot be retracted by the alternate flaps system.

OFF – normal operating position.

DOWN (spring loaded to OFF) –

- (momentary) fully extends LE devices using standby hydraulic pressure
- (hold) electrically extends TE flaps until released.

9 Feel Differential Pressure (FEEL DIFF PRESS) Light

Armed when the TE flaps are up or down.

Illuminated (amber) -

- indicates excessive differential pressure in the elevator feel computer.

Note: Excessive differential pressure can be caused by erroneous activation of the Elevator Feel Shift module.

10 Speed Trim Failure (SPEED TRIM FAIL) Light

Illuminated (amber) –

- indicates failure of the speed trim system
- indicates failure of a single FCC channel when MASTER CAUTION light recall is activated and light extinguishes when Master Caution System is reset.

11 Mach Trim Failure (MACH TRIM FAIL) Light

Illuminated (amber) –

- indicates failure of the mach trim system
- indicates failure of a single FCC channel when MASTER CAUTION light recall is activated and light extinguishes when master caution system is reset.

12 Automatic Slats Failure (AUTO SLAT FAIL) Light

Illuminated (amber) –

- indicates failure of the auto slat system
- indicates failure of a single Stall Management/Yaw Damper (SMYD) computer when illuminated during MASTER CAUTION recall and extinguishes when master caution system is reset.

Stabilizer

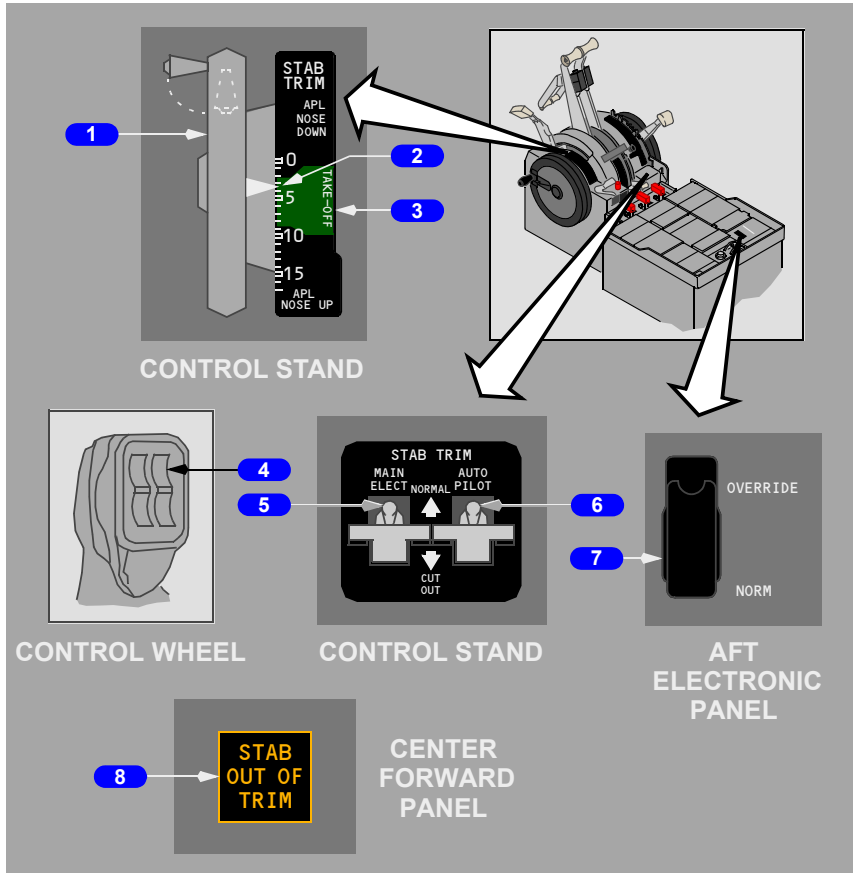

1 Stabilizer Trim Wheel

- provides for manual operation of stabilizer
- overrides any other stabilizer trim inputs
- rotates when stabilizer is in motion.

Note: Handle should be folded inside stabilizer trim wheel for normal operation

2 Stabilizer Trim Indicator

Indicates units of airplane trim on the adjacent scale.

3 Stabilizer Trim Green Band Range

Corresponds to allowable range of trim settings for takeoff.

4 Stabilizer Trim Switches (spring-loaded to neutral)

Push (both) –

- electrically commands stabilizer trim in desired direction
- autopilot disengages if engaged.

5 Stabilizer Trim Main Electric (MAIN ELECT) Cutout Switch

NORMAL – normal operating position.

CUTOFF – deactivates stabilizer trim switch operation.

6 Stabilizer Trim AUTOPILOT Cutout Switch

NORMAL – normal operating position.

CUTOFF –

- deactivates autopilot stabilizer trim operation
- autopilot disengages if engaged.

7 Stabilizer Trim Override Switch

OVERRIDE – bypasses the control column actuated stabilizer trim cutoff switches to restore power to the Stabilizer Trim Switches

NORM (guarded position) – normal operating position.

8 Stabilizer Out of Trim (STAB OUT OF TRIM) Light

Refer to Chapter 4 – Automatic Flight

Rudder

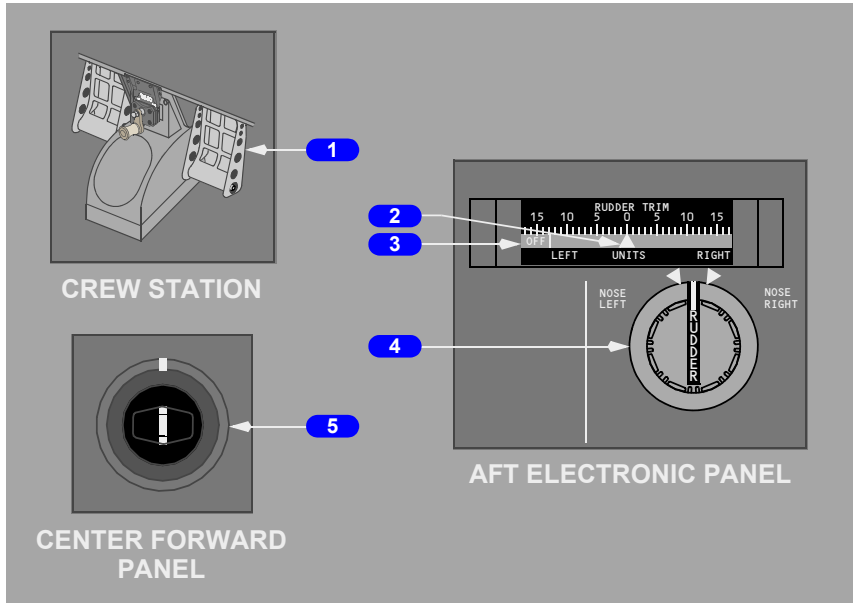

1 Rudder Pedals

Push –

- controls rudder position
- permits limited nose gear steering up to 7 degrees each side of center.

2 Rudder Trim Indicator

Indicates units of rudder trim.

3 Rudder Trim OFF Flag

Illuminated (amber) (in view) – rudder trim indicator is inoperative.

4 Rudder Trim Control (spring-loaded to neutral)

Rotate – electrically trims the rudder in the desired direction.

5 YAW DAMPER Indicator

- Indicates main yaw damper movement of rudder
- pilot rudder pedal inputs are not indicated.

Aileron / Elevator / Flight Spoilers

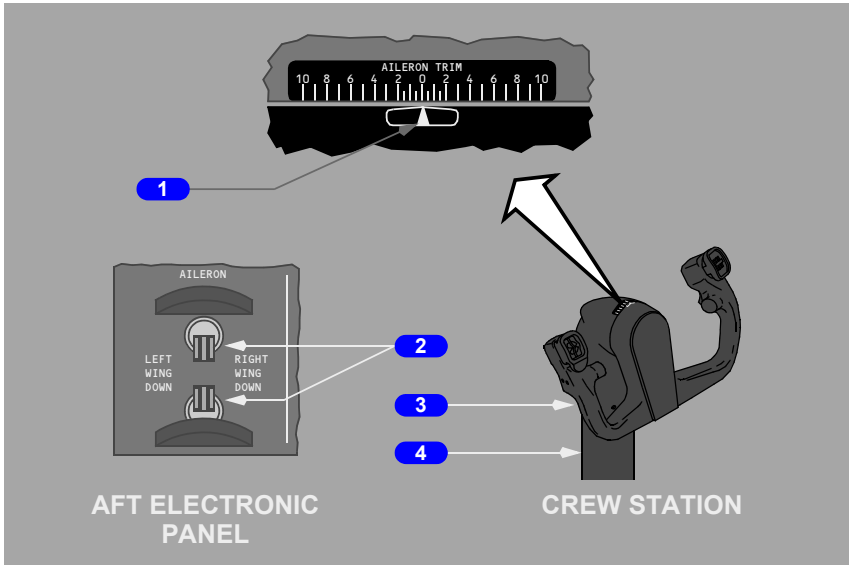

1 AILERON TRIM Indicator

Indicates units of aileron trim.

2 AILERON Trim Switches (spring-loaded to the neutral position)

Movement of both switches repositions the aileron neutral control position.

3 Control Wheel

Rotate – operates ailerons and flight spoilers in desired direction.

4 Control Column

Push/Pull –

- operates elevators in the desired direction
- movement opposing stabilizer trim stops electric trimming.

Speed Brakes

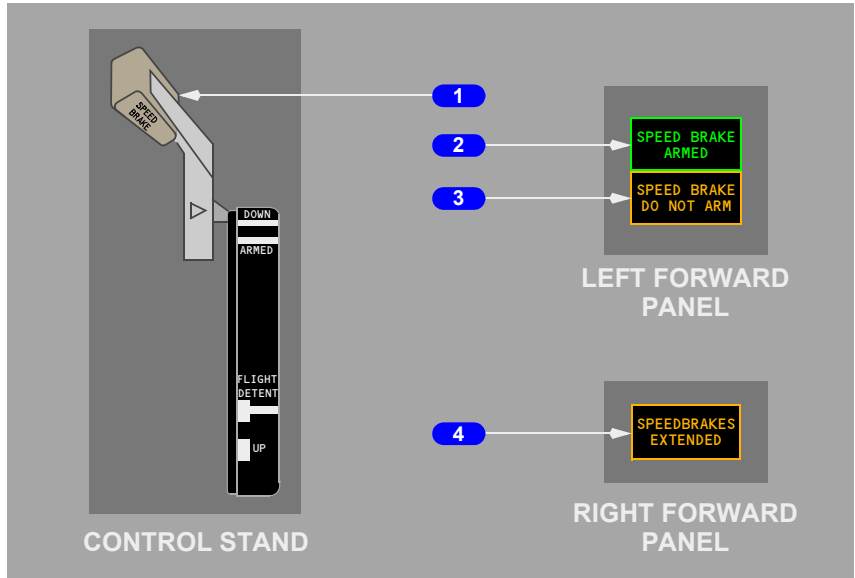

1 SPEED BRAKE Lever

DOWN (detent) – all flight and ground spoiler panels in faired position.

ARMED –

- automatic speed brake system armed
- upon touchdown, the SPEED BRAKE lever moves to the UP position, and all flight and ground spoilers extend.

FLIGHT DETENT – all flight spoilers are extended to their maximum position for inflight use.

UP – all flight and ground spoilers are extended to their maximum position for ground use.

2 SPEED BRAKE ARMED Light

Light deactivated when SPEED BRAKE lever is in the DOWN position.

Illuminated (green) – indicates valid automatic speed brake system inputs.

3 SPEED BRAKE DO NOT ARM Light

Light deactivated when SPEED BRAKE lever is in the DOWN position.

Illuminated (amber) –

- indicates abnormal condition or test inputs to the automatic speed brake system

4 SPEEDBRAKES EXTENDED Light

Illuminated (amber) –

- in-flight -
 - SPEED BRAKE lever is beyond the ARMED position, and
 - TE flaps extended more than flaps 10, or
 - radio altitude less than 800 feet
- on the ground -
 - SPEED BRAKE lever is in the DOWN detent,
 - ground spoilers are not stowed.

Note: On the ground, the SPEEDBRAKES EXTENDED light does not illuminate when hydraulic system A pressure is less than 750 psi.

Trailing Edge Flaps

YE321 - YE326

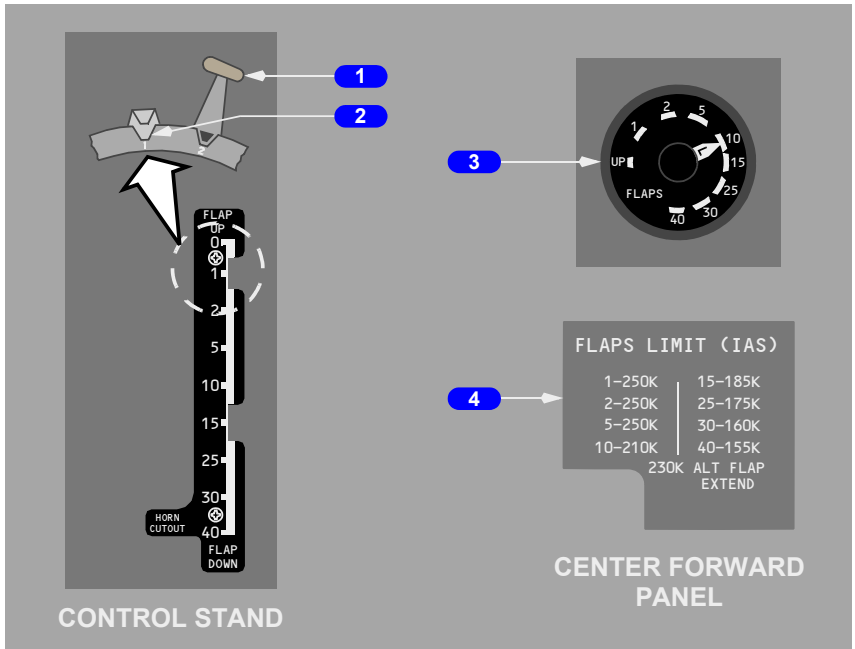

YA371 - YA377

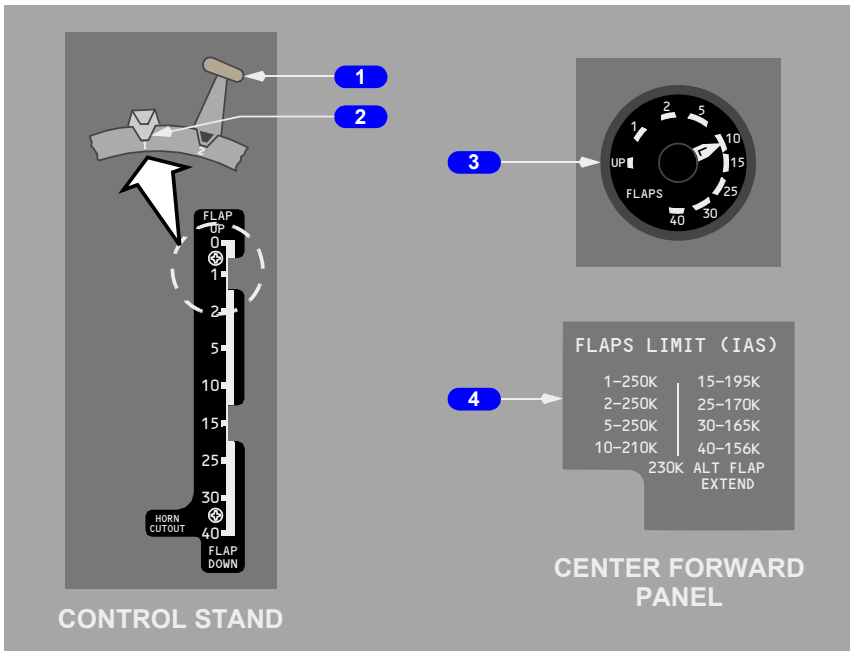

YC201 - YC207

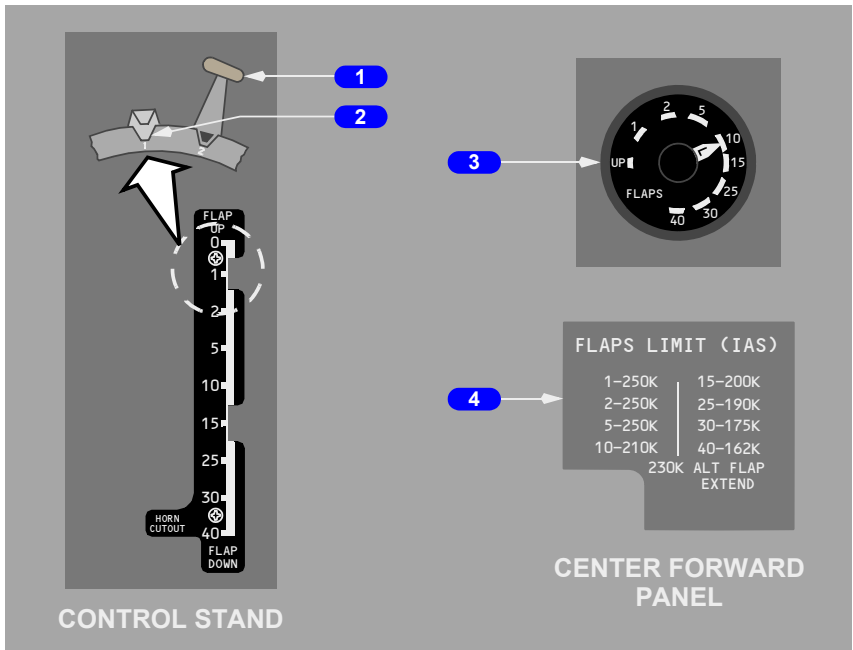

1 FLAP Lever

- selects position of flap control valve, directing hydraulic pressure for flap drive unit
- position of the LE devices is determined by selecting TE flap position
- flap positions 30 and 40 arm the flap load relief system.

2 Flap Gates

Prevents inadvertent flap lever movement beyond:

- position 1 - to check flap position for one engine inoperative go-around
- position 15 - to check flap position for normal go-around.

3 Flap Position Indicator

- indicates position of left and right TE flaps
- provides TE flaps asymmetry and skew indication.

4 FLAPS LIMIT Placard

Indicates maximum speed for each flap setting.

Leading Edge Devices

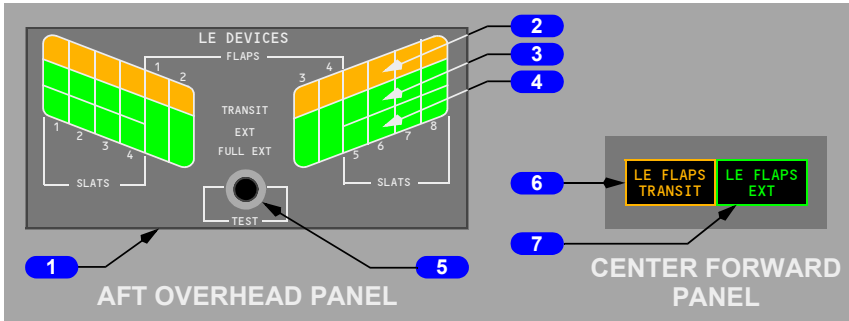

1 Leading Edge Devices (LE DEVICES) Annunciator Panel

Indicates position of individual LE flaps and slats.

Extinguished – related LE device retracted.

2 Leading Edge Devices TRANSIT Lights

Illuminated (amber) – related LE device in transit.

3 Leading Edge Devices Extended (EXT) Lights

Illuminated (green) – related LE slat in extended (intermediate) position.

4 Leading Edge Devices Full Extended (FULL EXT) Lights

Illuminated (green) – related LE device fully extended.

5 Leading Edge Annunciator Panel TEST Switch

Press – tests all annunciator panel lights.

6 Leading Edge Flaps Transit (LE FLAPS TRANSIT) Light

Illuminated (amber) –

- any LE device in transit
- any LE device not in programmed position with respect to TE flaps
- a LE slat skew condition exists (slats 2 through 7 only)
- during alternate flap extension until LE devices are fully extended and TE flaps reach flaps 10.

Note: Light is inhibited during autoslat operation in flight.

737 Flight Crew Operations Manual

7 Leading Edge Flaps Extended (LE FLAPS EXT) Light

Illuminated (green) –

- all LE flaps extended and all LE slats in extended (intermediate) position (TE flap positions 1, 2 and 5)
- all LE devices fully extended (TE flap positions 10 through 40).

Intentionally
Blank



Introduction

The primary flight control system uses conventional control wheel, column and pedals linked mechanically to hydraulic power control units which command the primary flight control surfaces; ailerons, elevators and rudder. The flight controls are powered by redundant hydraulic sources; system A and system B. Either hydraulic system can operate all primary flight controls. The ailerons and elevators may be operated manually if required. The rudder may be operated by the standby hydraulic system if system A and system B pressure is not available.

The secondary flight controls, high lift devices consisting of trailing edge (TE) flaps and leading edge (LE) flaps and slats (LE devices), are powered by hydraulic system B. In the event hydraulic system B fails, the TE flaps can be operated electrically. Under certain conditions the power transfer unit (PTU) automatically powers the LE devices. (Refer to Chapter 13, Hydraulics, Power Transfer Unit). They can also be extended using standby hydraulic pressure.

Pilot Controls

The pilot controls consist of:

- two control columns
- two control wheels
- two pairs of rudder pedals
- SPEED BRAKE lever
- FLAP lever
- STAB TRIM cutout switches
- STAB TRIM override switch
- stabilizer trim switches
- stabilizer trim wheel
- AILERON trim switches
- RUDDER trim control
- YAW DAMPER switch
- ALTERNATE FLAPS master switch
- alternate flaps position switch
- FLT CONTROL switches
- flight SPOILER switches

The columns and wheels are connected through transfer mechanisms which allow the pilots to bypass a jammed control or surface.

There is a rigid connection between both pairs of rudder pedals.

The SPEED BRAKE lever allows manual or automatic symmetric actuation of the spoilers.

Flight Control Surfaces

Pitch control is provided by:

- two elevators
- a movable horizontal stabilizer.

Roll control is provided by:

- two ailerons
- eight flight spoilers.

Yaw control is provided by a single rudder. During takeoff, the rudder becomes aerodynamically effective between 40 and 60 knots.

TE flaps and LE flaps and slats provide high lift for takeoff, approach and landing.

In the air symmetric flight spoilers are used as speed brakes. On the ground symmetric flight and ground spoilers destroy lift and increase braking efficiency.

Flight Control Surfaces Location

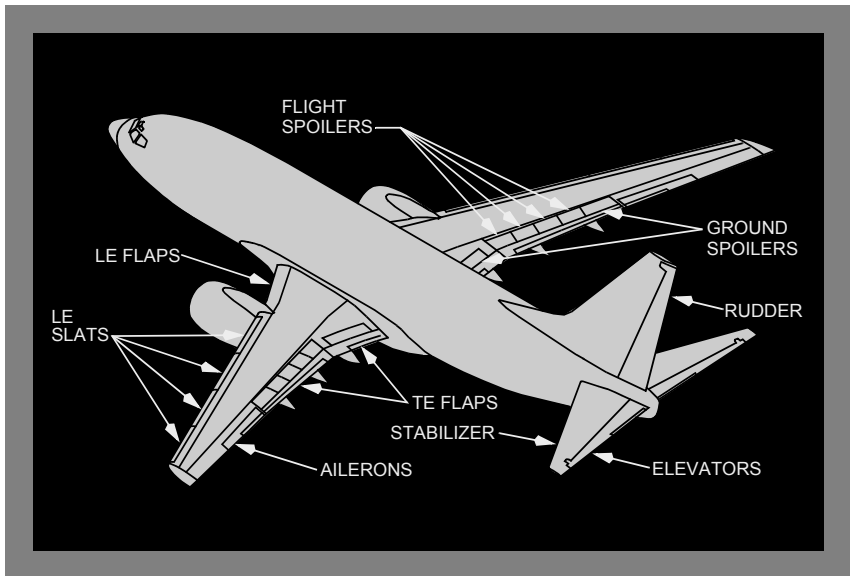

Roll Control

The roll control surfaces consist of hydraulically powered ailerons and flight spoilers, which are controlled by rotating either control wheel.

Ailerons

The ailerons provide roll control around the airplane's longitudinal axis. The ailerons are positioned by the pilots' control wheels. The A and B FLT CONTROL switches control hydraulic shutoff valves. These valves can be used to isolate each aileron, as well as the elevators and rudder, from related hydraulic system pressure.

The Captain's control wheel is connected by cables to the aileron power control units (PCUs) through the aileron feel and centering unit. The First Officer's control wheel is connected by cables to the spoiler PCUs through the spoiler mixer. The two control wheels are connected by a cable drive system which allows actuation of both ailerons and spoilers by either control wheel. With total hydraulic power failure the ailerons can be mechanically positioned by rotating the pilots' control wheels. Control forces are higher due to friction and aerodynamic loads.

Aileron Transfer Mechanism

If the ailerons or spoilers are jammed, force applied to the Captain's and the First Officer's control wheels will identify which system, ailerons or spoilers, is usable and which control wheel, Captain's or First Officer's, can provide roll control. If the aileron control system is jammed, force applied to the First Officer's control wheel provides roll control from the spoilers. The ailerons and the Captain's control wheel are inoperative. If the spoiler system is jammed, force applied to the Captain's control wheel provides roll control from the ailerons. The spoilers and the First Officer's control wheel are inoperative.

Aileron Trim

Dual AILERON trim switches, located on the aft electronic panel, must be pushed simultaneously to command trim changes. The trim electrically repositions the aileron feel and centering unit, which causes the control wheel to rotate and redefines the aileron neutral position. The amount of aileron trim is indicated on a scale on the top of each control column.

If aileron trim is used with the autopilot engaged, the trim is not reflected in the control wheel position. The autopilot overpowers the trim and holds the control wheel where it is required for heading/track control. Any aileron trim applied when the autopilot is engaged can result in an out of trim condition and an abrupt rolling movement when the autopilot is disconnected.

Flight Spoilers

Four flight spoilers are located on the upper surface of each wing. Each hydraulic system, A and B, is dedicated to a different set of spoiler pairs to provide isolation and maintain symmetric operation in the event of hydraulic system failure.

Hydraulic pressure shutoff valves are controlled by the two flight SPOILER switches.

Flight spoiler panels are used as speed brakes to increase drag and reduce lift, both in flight and on the ground. The flight spoilers also supplement roll control in response to control wheel commands. A spoiler mixer, connected to the aileron cable-drive, controls the hydraulic power control units on each spoiler panel to provide spoiler movement proportional to aileron movement.

The flight spoilers rise on the wing with up aileron and remain faired on the wing with down aileron. When the control wheel is displaced more than approximately 10°, spoiler deflection is initiated.

Roll Control Schematic

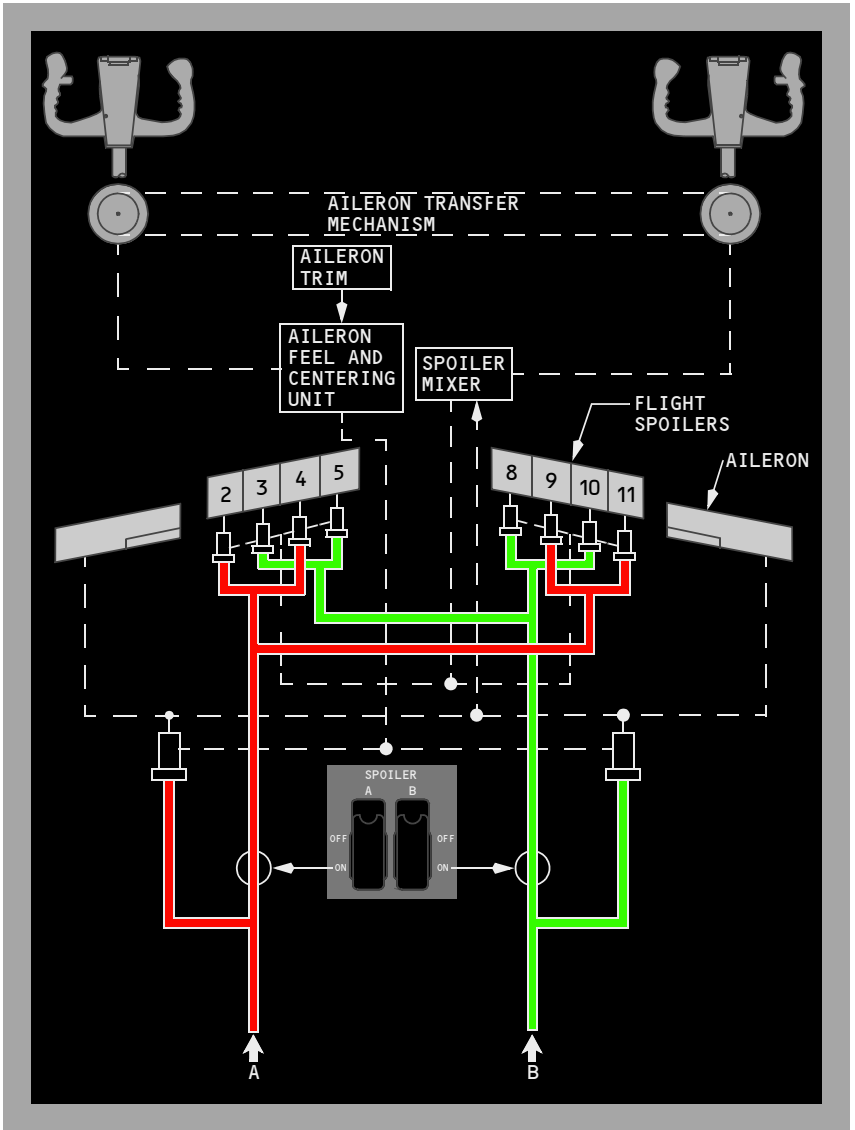

Pitch Control

The pitch control surfaces consist of hydraulically powered elevators and an electrically powered stabilizer. The elevators are controlled by forward or aft movement of the control column. The stabilizer is controlled by autopilot trim or manual trim.

Elevators

The elevators provide pitch control around the airplane's lateral axis. The elevators are positioned by the pilots' control columns. The A and B FLT CONTROL switches control hydraulic shutoff valves for the elevators.

Cables connect the pilots' control columns to elevator power control units (PCUs) which are powered by hydraulic system A and B. The elevators are interconnected by a torque tube. With loss of hydraulic system A and B the elevators can be mechanically positioned by forward or aft movement of the pilots' control columns. Control forces are higher due to friction and aerodynamic loads.

Elevator Control Column Override Mechanism

In the event of a control column jam, an override mechanism allows the control columns to be physically separated. Applying force against the jam will breakout either the Captain's or First Officer's control column. Whichever column moves freely after the breakout can provide adequate elevator control.

Although total available elevator travel is significantly reduced, there is sufficient elevator travel available for landing flare. Column forces are higher and exceed those experienced during manual reversion. If the jam exists during the landing phase, higher forces are required to generate sufficient elevator control to flare for landing. Stabilizer trim is available to counteract the sustained control column force.

Elevator Feel System

The elevator feel computer provides simulated aerodynamic forces using airspeed (from the elevator pitot system) and stabilizer position. Feel is transmitted to the control columns by the elevator feel and centering unit. To operate the feel system the elevator feel computer uses either hydraulic system A or B pressure, whichever is higher. When either hydraulic system or elevator feel pitot system fails, excessive differential hydraulic pressure is sensed in the elevator feel computer and the FEEL DIFF PRESS light illuminates.

Mach Trim System

A Mach trim system provides speed stability at the higher Mach numbers. Mach trim is automatically accomplished above Mach .615 by adjusting the elevators with respect to the stabilizer as speed increases. The flight control computers use Mach information from the ADIRU to compute a Mach trim actuator position. The Mach trim actuator repositions the elevator feel and centering unit which adjusts the control column neutral position.

Stabilizer

The horizontal stabilizer is positioned by a single electric trim motor controlled through either the stab trim switches on the control wheel or autopilot trim. The stabilizer may also be positioned by manually rotating the stabilizer trim wheel.

Stabilizer Trim

Stabilizer trim switches on each control wheel actuate the electric trim motor through the main electric stabilizer trim circuit when the airplane is flown manually. With the autopilot engaged, stabilizer trim is accomplished through the autopilot stabilizer trim circuit. The main electric and autopilot stabilizer trim have two speed modes: high speed with flaps extended and low speed with flaps retracted. If the autopilot is engaged, actuating either pair of stabilizer trim switches automatically disengages the autopilot. The stabilizer trim wheels rotate whenever electric stabilizer trim is actuated.

The STAB TRIM MAIN ELECT cutout switch and the STAB TRIM AUTOPILOT cutout switch, located on the control stand, are provided to allow the autopilot or main electric trim inputs to be disconnected from the stabilizer trim motor.

Control column actuated stabilizer trim cutout switches stop operation of the main electric and autopilot trim when the control column movement opposes trim direction. When the STAB TRIM override switch is positioned to OVERRIDE, electric trim can be used regardless of control column position.

Manual stabilizer control is accomplished through cables which allow the pilot to position the stabilizer by rotating the stabilizer trim wheels. The stabilizer is held in position by two independent brake systems. Manual rotation of the trim wheels can be used to override autopilot or main electric trim. The effort required to manually rotate the stabilizer trim wheels may be higher under certain flight conditions. Grasping the stabilizer trim wheel will stop stabilizer motion.

Stabilizer Trim Operation with Forward or Aft CG

In the event the stabilizer is trimmed to the end of the electrical trim limits, additional trim is available through the use of the manual trim wheels. If manual trim is used to position the stabilizer beyond the electrical trim limits, the stabilizer trim switches may be used to return the stabilizer to electrical trim limits.

Stabilizer Position Indication and Green Band

Stabilizer position is displayed in units on two STAB TRIM indicators located inboard of each stabilizer trim wheel. The STAB TRIM indicators also display the TAKEOFF green band indication.

The trim authority for each mode of trim is limited to:

- Main Electric Trim
 - YE321 - YE326
 - flaps retracted 4.10 to 14.5 units
 - YA371 - YA377
 - flaps retracted 4.30 to 14.5 units
 - YC201 - YC207
 - flaps retracted 3.95 to 14.5 units
 - flaps extended 0.05 to 14.5 units
- Autopilot Trim 0.05 to 14.5 units
- Manual Trim -0.20 to 16.9 units.

The green band range of the STAB TRIM indicator shows the takeoff trim range. An intermittent horn sounds if takeoff is attempted with the stabilizer trim outside the takeoff trim range.

Speed Trim System

The speed trim system (STS) is a speed stability augmentation system designed to improve flight characteristics during operations with a low gross weight, aft center of gravity and high thrust when the autopilot is not engaged. The purpose of the STS is to return the airplane to a trimmed speed by commanding the stabilizer in a direction opposite the speed change. The STS monitors inputs of stabilizer position, thrust lever position, airspeed and vertical speed and then trims the stabilizer using the autopilot stabilizer trim. As the airplane speed increases or decreases from the trimmed speed, the stabilizer is commanded in the direction to return the airplane to the trimmed speed. This increases control column forces to force the airplane to return to the trimmed speed. As the airplane returns to the trimmed speed, the STS commanded stabilizer movement is removed.

STS operates most frequently during takeoffs, climb and go-arounds. Conditions for speed trim operation are listed below:

- Airspeed between 100 KIAS and Mach 0.5
- 10 seconds after takeoff
- 5 seconds following release of trim switches
- Autopilot not engaged
- Sensing of trim requirement

Stall Identification

Stall identification and control is enhanced by the yaw damper, the Elevator Feel Shift (EFS) module and the speed trim system. These three systems work together to help the pilot identify and prevent further movement into a stall condition.

During high AOA operations, the SMYD reduces yaw damper commanded rudder movement.

The EFS module increases hydraulic system A pressure to the elevator feel and centering unit during a stall. This increases forward control column force to approximately four times normal feel pressure. The EFS module is armed whenever an inhibit condition is not present. Inhibit conditions are: on the ground, radio altitude less than 100 feet and autopilot engaged. However, if EFS is active when descending through 100 feet RA, it remains active until AOA is reduced below approximately stickshaker threshold. There are no flight deck indications that the system is properly armed or activated.

As airspeed decreases towards stall speed, the speed trim system trims the stabilizer nose down and enables trim above stickshaker AOA. With this trim schedule the pilot must pull more aft column to stall the airplane. With the column aft, the amount of column force increase with the onset of EFS module is more pronounced.

Yaw Control

Yaw control is accomplished by a hydraulically powered rudder and a digital yaw damper system. The rudder is controlled by displacing the rudder pedals. The yaw damping functions are controlled through the stall management/yaw damper (SMYD) computers.

Rudder

YA371

The rudder provides yaw control about the airplane's vertical axis. The A and B FLT CONTROL switches control hydraulic shutoff valves for the rudder and the standby rudder.

Each set of rudder pedals is mechanically connected by cables to the input levers of the main and standby rudder PCUs. The main rudder PCU is powered by hydraulic system A and B. The standby rudder PCU is powered by the standby hydraulic system. At speeds above approximately 135 kts, hydraulic system A pressure to the rudder PCU is limited by approximately 50%. This function limits full rudder authority in flight after takeoff and before landing.

The standby rudder PCU is powered by the standby hydraulic system. The standby hydraulic system is provided as a backup if system A and/or B pressure is lost. With the standby PCU powered the pilot retains adequate rudder control capability. It can be operated manually through the FLT CONTROL switches or automatically. (Refer to Chapter 13, Hydraulics, Standby Hydraulic System)

Rudder Trim

The RUDDER trim control, located on the aft electronic panel, electrically repositions the rudder feel and centering unit which adjusts the rudder neutral position. The rudder pedals are displaced proportionately. The RUDDER TRIM indicator displays the rudder trim position in units.

Rudder (with Rudder System Enhancement Program (RSEP) installed)

YA372 - YE326

The rudder provides yaw control about the airplane's vertical axis. The A and B FLT CONTROL switches control hydraulic shutoff valves for the rudder and the standby rudder.

Each set of rudder pedals is mechanically connected by cables to the input levers of the main and standby rudder PCUs. The main PCU consists of two independent input rods, two individual control valves, and two separate actuators; one for Hydraulic system A and one for Hydraulic system B. The standby rudder PCU is controlled by a separate input rod and control valve and powered by the standby hydraulic system. All three input rods have individual jam override mechanisms that allows input commands to continue to be transferred to the remaining free input rods if an input rod or downstream hardware is hindered or jammed.

At speeds above approximately 135 kts, both hydraulic system A and B pressure are each reduced within the main PCU by approximately 25% each. This function limits full rudder authority in flight after takeoff and before landing.

The main rudder PCU contains a Force Fight Monitor (FFM) that detects opposing pressure (force fight) between A and B actuators. This may occur if either system A or B input is jammed or disconnected. The FFM output is used to automatically turn on the Standby Hydraulic pump, open the standby rudder shutoff valve to pressurize the standby rudder PCU, and illuminate the STBY RUD ON, Master Caution, and Flight Control (FLT CONT) lights.

The standby rudder PCU is powered by the standby hydraulic system. The standby hydraulic system is provided as a backup if system A and/or B pressure is lost. With the standby PCU powered the pilot retains adequate rudder control capability. It can be operated manually through the FLT CONTROL switches or automatically. (Refer to Chapter 13, Hydraulics, Standby Hydraulic System)

An amber STBY RUD ON light illuminates when the standby rudder hydraulic system is pressurized. The standby rudder system can be pressurized with either Flight Control switch, automatically during takeoff or landing (Refer to Chapter 13, Hydraulics, Standby Hydraulic System) or automatically by the Force Fight Monitor. The STBY RUD ON light illumination activates Master Caution and Flight Control warning lights on the Systems Annunciation Panel.

Rudder Trim

The RUDDER trim control, located on the aft electronic panel, electrically repositions the rudder feel and centering unit which adjusts the rudder neutral position. The rudder pedals are displaced proportionately. The RUDDER TRIM indicator displays the rudder trim position in units.

Yaw Damper

The yaw damper system consists of a main and standby yaw damper. Both yaw dampers are controlled through Stall Management/Yaw Damper (SMYD) computers. The SMYD computers receive inputs from both ADIRUs, both control wheels and the YAW DAMPER switch. SMYDs provide yaw damper inputs to the main rudder power control unit (PCU) or standby rudder PCU, as appropriate.

737 Flight Crew Operations Manual

Either yaw damper is capable of providing dutch roll prevention, gust damping and turn coordination. Yaw damper operation does not result in rudder pedal movement. Only main yaw damper inputs are shown on the yaw damper indicator. The pilot can override either main or standby yaw damper inputs using either the rudder pedals or trim inputs.

During normal operation the main yaw damper uses hydraulic system B and the SMYD computers provide continuous system monitoring. The YAW DAMPER Switch automatically moves to OFF, the amber YAW DAMPER light illuminates and the YAW DAMPER switch cannot be reset to ON when any of the following conditions occur:

- SMYD senses a yaw damper system fault,
- SMYD senses that the yaw damper does not respond to a command,
- B FLT CONTROL switch is positioned to OFF or STBY RUD.

During manual reversion flight (loss of hydraulic system A and B pressure), both FLT CONTROL switches are positioned to STBY RUD. In this case, the YAW DAMPER switch can be reset to ON and the standby hydraulic system powers the standby yaw damper. During Standby Yaw Damper operation, movement of the control wheel sends a signal to the standby rudder PCU to move the rudder. This gives rudder assist to help turn the airplane when control of the ailerons is through manual reversion.

Yaw Control Schematic

YA371

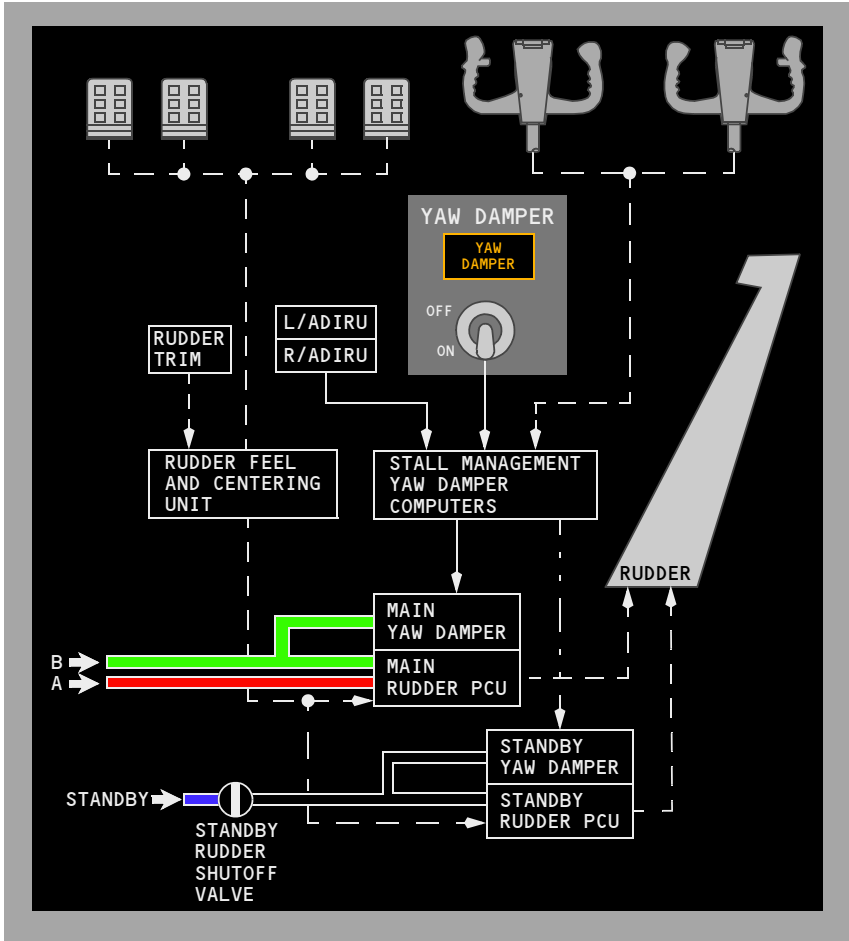

737 Flight Crew Operations Manual

YA372 - YE326

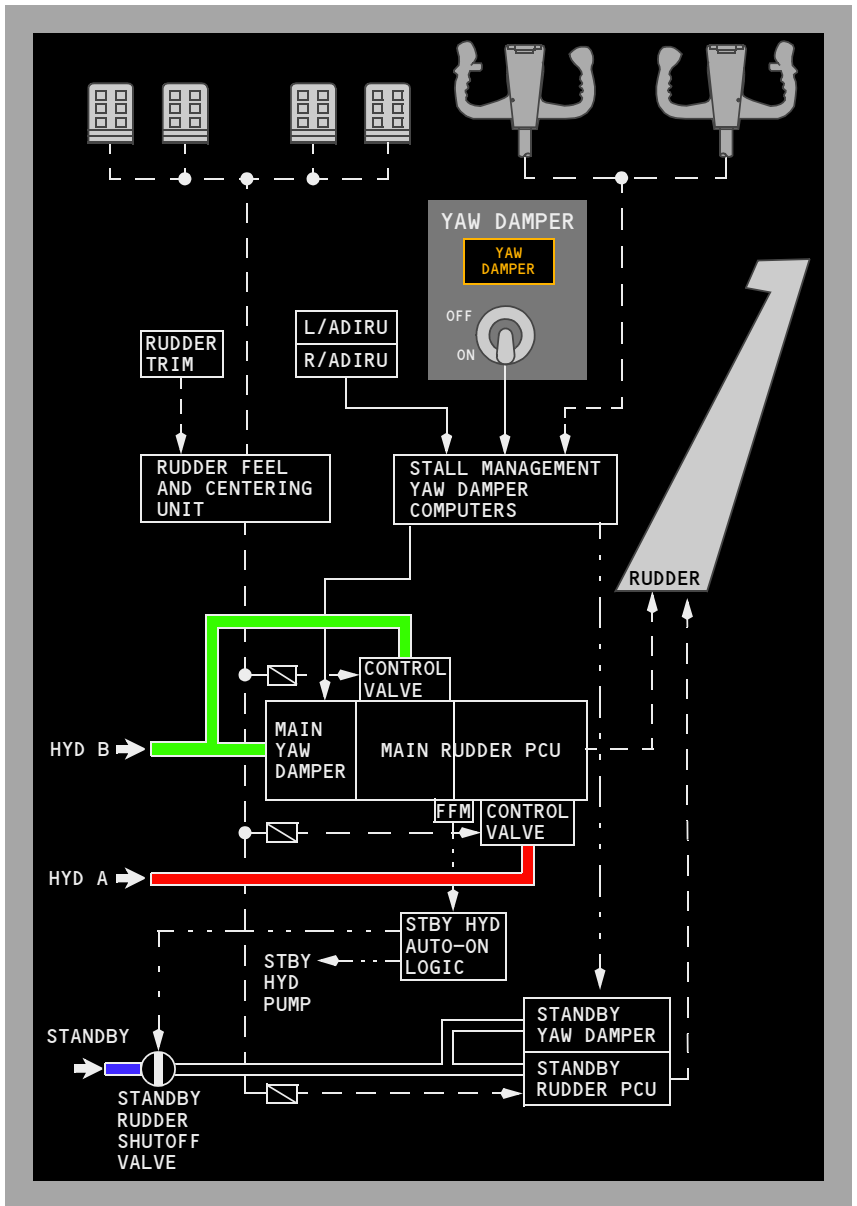

Speed Brakes

The speed brakes consist of flight spoilers and ground spoilers. Hydraulic system A powers all four ground spoilers, two on the upper surface of each wing. The SPEED BRAKE lever controls the spoilers. When the SPEED BRAKE lever is actuated all the spoilers extend when the airplane is on the ground and only the flight spoilers extend when the airplane is in the air.

The SPEEDBRAKES EXTENDED light provides an indication of spoiler operation in-flight and on the ground. In-flight, the light illuminates to warn the crew that the speed brakes are extended while in the landing configuration or below 800 feet AGL. On the ground, the light illuminates when hydraulic pressure is sensed in the ground spoiler shutoff valve with the speed brake lever in the DOWN position.

In-Flight Operation

Operating the SPEED BRAKE lever in flight causes all flight spoiler panels to rise symmetrically to act as speed brakes. Caution should be exercised when deploying flight spoilers during a turn, as they greatly increase roll rate. When the speed brakes are in an intermediate position roll rates increase significantly. Moving the SPEED BRAKE lever beyond the FLIGHT DETENT causes buffeting and is prohibited in flight.

Ground Operation

During landing, the auto speed brake system operates when these conditions occur:

- SPEED BRAKE lever is in the ARMED position
- SPEED BRAKE ARMED light is illuminated
- radio altitude is less than 10 feet
- landing gear strut compresses on touchdown

Note: Compression of any landing gear strut enables the flight spoilers to deploy. Compression of the right main landing gear strut enables the ground spoilers to deploy.

- both thrust levers are retarded to IDLE
- main landing gear wheels spin up (more than 60 kts).

The SPEED BRAKE lever automatically moves to the UP position and the spoilers deploy.

If a wheel spin-up signal is not detected, when the air/ground system senses ground mode (any gear strut compresses) the SPEED BRAKE lever moves to the UP position and flight spoiler panels deploy automatically. When the right main landing gear strut compresses, a mechanical linkage opens the ground spoiler bypass valve and the ground spoilers deploy.

737 Flight Crew Operations Manual

If the SPEED BRAKE lever is in the DOWN position during landing or rejected takeoff, the auto speed brake system operates when these conditions occur:

- main landing gear wheels spin up (more than 60 kts)
- both thrust levers are retarded to IDLE
- reverse thrust levers are positioned for reverse thrust.

The SPEED BRAKE lever automatically moves to the UP position and spoilers deploy.

After an RTO or landing, if either thrust lever is advanced, the SPEED BRAKE lever automatically moves to the DOWN detent and all spoiler panels retract. The spoiler panels may also be retracted by manually moving the SPEED BRAKE lever to the DOWN detent.

Speed Brakes Schematic

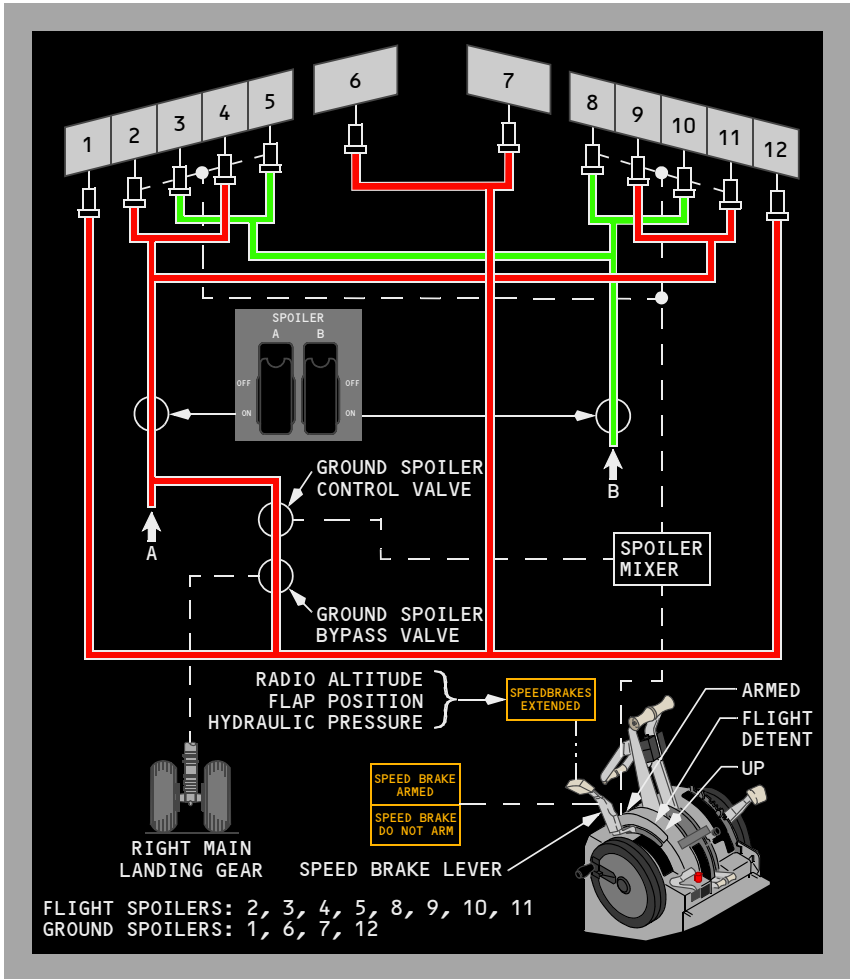

Flaps and Slats

The flaps and slats are high lift devices that increase wing lift and decrease stall speed during takeoff, low speed maneuvering and landing.

LE devices consist of four flaps and eight slats: two flaps inboard and four slats outboard of each engine. Slats extend to form a sealed or slotted leading edge depending on the TE flap setting. The TE devices consist of double slotted flaps inboard and outboard of each engine.

TE flap positions 1–15 provide increased lift; positions 15–40 provide increased lift and drag. Flap positions 30 and 40 are normal landing flap positions.

To prevent excessive structural loads from increased Mach at higher altitude, flap extension above 20,000 feet should not be attempted.

Flap and Slat Sequencing

LE devices and TE flaps are normally extended and retracted by hydraulic power from system B. When the FLAP lever is in the UP detent, all flaps and LE devices are commanded to the retracted or up position. Moving the FLAP lever aft allows selection of flap detent positions 1, 2, 5, 10, 15, 25, 30 or 40. The LE devices deployment is sequenced as a function of TE flaps deployment.

When the FLAP lever is moved from the UP position to the 1, 2, or 5 position, the TE flaps extend to the commanded position and the LE:

- flaps extend to the full extended position and
- slats extend to the extend position.

When the FLAP lever is moved beyond the 5 position the TE flaps extend to the commanded position and the LE:

- flaps remain at the full extended position and
- slats extend to the full extended position.

The LE devices sequence is reversed upon retraction.

Mechanical gates hinder inadvertent FLAP lever movement beyond flaps 1 for one engine inoperative go-around and flaps 15 for normal go-around.

Indicator lights on the center instrument panel provide overall LE devices position status. The LE DEVICES annunciator panel on the aft overhead panel indicates the positions of the individual flaps and slats.

Flap Load Relief

The flaps/slat electronics unit (FSEU) provides a TE flap load relief function which protects the flaps from excessive air loads. This function is operative at the flaps 30 and flaps 40 positions only. The FLAP lever does not move, but the flap position indicator displays flap retraction and re-extension.

When the flaps are set at 40, the TE flaps:

- retract to 30 if airspeed exceeds 163 knots
- re-extend when airspeed is reduced below 158 knots.

When the flaps are set at 30, the TE flaps:

- retract to 25 if the airspeed exceeds 176 knots
- re-extend when airspeed is reduced below 171 knots.

Autoslats

At flap positions 1, 2 and 5 an autoslat function is available that moves the LE slats to full extended if the airplane approaches a stall condition.

The autoslat system is designed to enhance airplane stall characteristics at high angles of attack during takeoff or approach to landing. When TE flaps 1 through 5 are selected, the LE slats are in the extend position. As the airplane approaches the stall angle, the slats automatically drive to the full extended position prior to stick shaker activation. The slats return to the extend position when the pitch angle is sufficiently reduced below the stall critical attitude.

Autoslat operation is normally powered by hydraulic system B. An alternate source of power is provided by system A through a power transfer unit (PTU) if a loss of pressure is sensed from the higher volume system B engine driven pump. The PTU provides system A pressure to power a hydraulic motorized pump, pressurizing system B fluid to provide power for the autoslat operation. (Refer to Chapter 13, Hydraulics, Power Transfer Unit)

Alternate Extension

In the event that hydraulic system B fails, an alternate method of extending the LE devices and extending and retracting the TE flaps is provided.

The TE flaps can be operated electrically through the use of two alternate flap switches. The guarded ALTERNATE FLAPS master switch closes a flap bypass valve to prevent hydraulic lock of the flap drive unit and arms the alternate flaps position switch. The ALTERNATE FLAPS position switch controls an electric motor that extends or retracts the TE flaps. The switch must be held in the DOWN position until the flaps reach the desired position. No asymmetry or skew protection is provided through the alternate (electrical) flap drive system.

When using alternate flap extension the LE flaps and slats are driven to the full extended position using power from the standby hydraulic system. In this case the ALTERNATE FLAPS master switch energizes the standby pump and the ALTERNATE FLAPS position switch, held in the down position momentarily, fully extends the LE devices.

Note: The LE devices cannot be retracted by the standby hydraulic system.

Leading Edge Devices and Trailing Edge Flaps Schematic

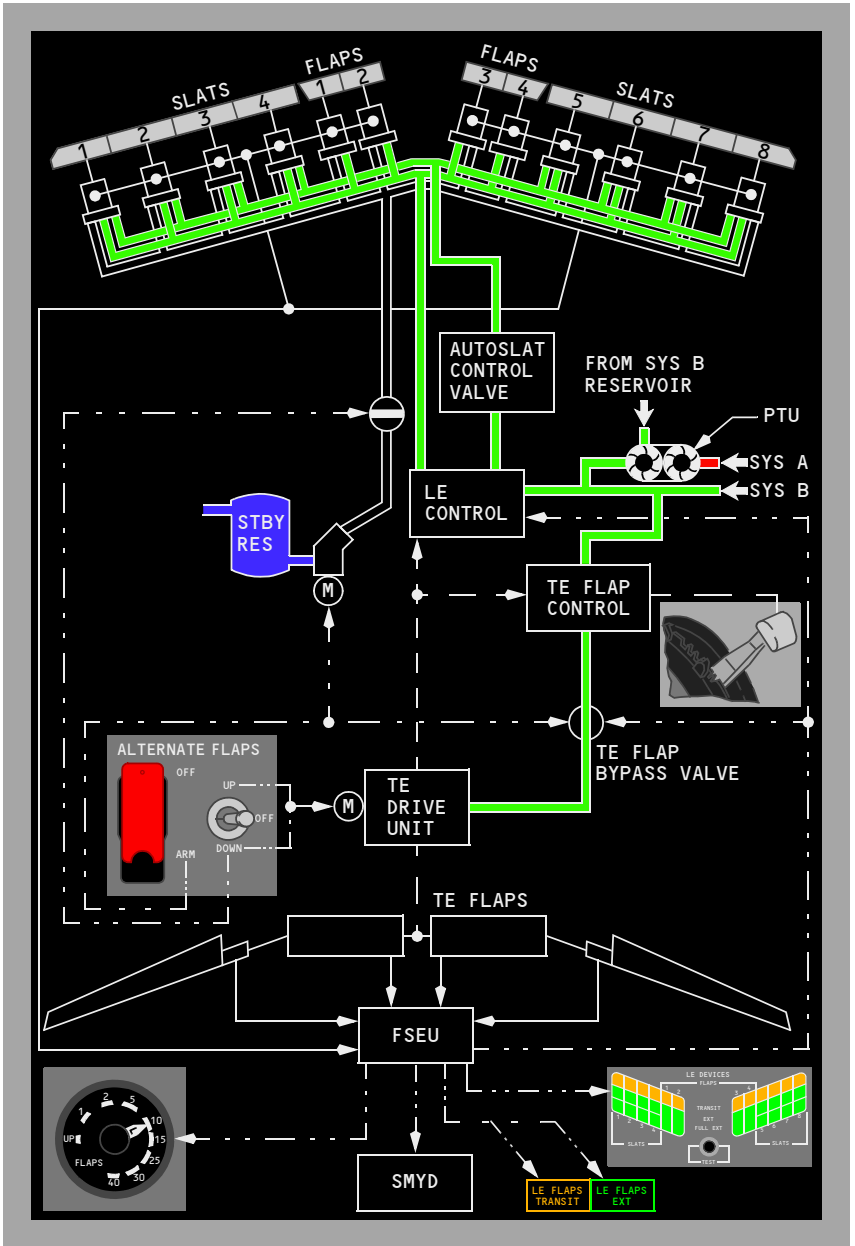

Asymmetry and Skew Detection, Protection and Indication

The FSEU monitors the TE flaps for asymmetry and skew conditions. It also monitors the LE devices for improper position and skew conditions on slats 2 through 7. If a flap on one wing does not align with the symmetrical flap on the other wing, there is a flap asymmetry condition. A skew condition occurs when a TE flap or LE slat panel does not operate at the same rate causing the panel to twist during extension or retraction.

Trailing Edge Flap Asymmetry and Skew

When the FSEU detects a trailing edge asymmetry or skew condition the FSEU:

- closes the TE flap bypass valve
- displays a needle split on the flap position indicator.

Leading Edge Device Improper Position or Skew

When the FSEU detects a LE device in an improper position or a LE slat skew condition, the LE FLAPS TRANSIT light remains illuminated and one of the following indications is displayed on the LE DEVICES annunciator panel:

- amber TRANSIT light illuminated
- incorrect green EXT or FULL EXT light illuminated
- no light illuminated.

There is no skew detection of the outboard slats, 1 and 8, or for the LE flaps. Slat skew detection is inhibited during autoslat operations.

Uncommanded Motion Detection, Protection and Indication

The FSEU provides protection from uncommanded motion by the LE devices or TE flaps.

Leading Edge Uncommanded Motion

Uncommanded motion is detected when no TE flap position or autoslat command is present and:

- two LE flaps move on one wing, or
- two or more slats move on one wing.

The FSEU shuts down the LE control and illuminates the amber LE FLAPS TRANSIT light.

In addition, to prevent uncommanded motion from occurring on the LE devices during cruise, the FSEU maintains pressure on the retract lines and depressurizes the extend and full extend lines.

737 Flight Crew Operations Manual

Trailing Edge Uncommanded Motion

Uncommanded motion is detected when no FLAP lever or flap load relief command is present and the TE flaps:

- move away from the commanded position
- continue to move after reaching a commanded position, or
- move in a direction opposite to that commanded.

The FSEU shuts down the TE drive unit by closing the TE flap bypass valve. The TE flap shutdown cannot be reset by the flight crew and they must use the alternate flap system to control TE flaps. The shutdown is indicated by the flap position indicator disagreeing with the FLAP lever position. There is no flap needle split.



Intentionally
Blank



EFIS/Map – Controls and Indicators	10.10.1
EFIS/Map Display System – Overview	10.10.1
Captain Outboard Display	10.10.2
Captain Inboard Display	10.10.3
First Officer Inboard Display	10.10.4
First Officer Outboard Display	10.10.5
Compact EFIS Format	10.10.6
Electronic Flight Instrument System (EFIS) –	
Mach/Airspeed Indicator (MASI)	10.10.7
Mach/Airspeed Indicator – General	10.10.7
Mach/Airspeed Indicator – Takeoff	10.10.9
Mach/Airspeed Indicator – Approach	10.10.11
Mach/Airspeed Indicator – IAS Disagree Alert	10.10.12
Mach/Airspeed Indicator Failure Flags	10.10.12
EFIS – Attitude Indicator	10.10.13
Attitude Indicator – General	10.10.13
Attitude Indicator – Navigation Performance Scales (NPS) Indicators	10.10.15
Attitude Indicator – Instrument Landing System Indications	10.10.17
Expanded Localizer Indications	10.10.19
Attitude Indicator Failure Flags	10.10.20
Traffic Alert and Collision Avoidance Indications	10.10.21
GPWS Annunciations	10.10.22
EFIS – Altimeter	10.10.22
Altimeter – General	10.10.22
Altimeter – Altitude Disagree Alert	10.10.24
Altimeter Failure Flag	10.10.25
EFIS – Vertical Speed Indicator	10.10.25
Vertical Speed Indicator – General	10.10.25
Vertical Speed Indicator Failure Flag	10.10.26

EFIS – Marker Beacon Indications	10.10.26
Marker Beacons Indications	10.10.26
Navigation Displays – Horizontal Situation Indicator (HSI)	10.10.27
Horizontal Situation Indicator – General	10.10.27
Horizontal Situation Indicator – Compact Display	10.10.28
Horizontal Situation Indicator Failure Flags	10.10.30
Navigation Displays – Radio Distance Magnetic Indicator (RDMI)	10.10.31
Radio Distance Magnetic Indicator – General	10.10.31
Radio Distance Magnetic Indicator Failure Flags	10.10.32
Navigation Displays – MAP Mode	10.10.33
Expanded MAP Mode	10.10.33
Center MAP Mode	10.10.35
Navigation Displays – Approach Mode	10.10.37
Expanded Approach Mode	10.10.37
Center Approach Mode	10.10.38
Navigation Displays – VOR Mode	10.10.39
Expanded VOR Mode	10.10.39
Center VOR Mode	10.10.40
Navigation Displays – Plan Mode	10.10.41
Plan Mode	10.10.41
Navigation Displays – Advisory Messages	10.10.42
Mode/Frequency Disagree Annunciation	10.10.42
Navigation Advisory Messages	10.10.43
TCAS Messages	10.10.44
Look-Ahead Terrain Messages (GPWS)	10.10.45
Predictive Windshear System (PWS) Message	10.10.46
Navigation Displays – Failure Indications and Flags	10.10.47
Failure Flags – Expanded MAP, Center MAP, Expanded APP, Expanded VOR Modes	10.10.47
Failure Flags – Center APP and Center VOR Modes	10.10.49
Additional Flags and Annunciations	10.10.50
Displays Control Panel Annunciation	10.10.50

737 Flight Crew Operations Manual

Display System Annunciations	10.10.51
Instrument Switch Annunciation	10.10.52
PFD/ND – Displays	10.11.1
PFD/ND Display System – Overview	10.11.1
Captain Outboard Display	10.11.2
Captain Inboard Display	10.11.3
First Officer Inboard Display	10.11.4
First Officer Outboard Display	10.11.5
Primary Flight Display (PFD)– PFD Airspeed Indications	10.11.6
PFD Airspeed Indications – General	10.11.6
PFD Airspeed Indications – Takeoff and Approach	10.11.8
PFD – Attitude Indications	10.11.11
Attitude Indications – General	10.11.11
PFD Navigation Performance Scales (NPS) Indications	10.11.14
PFD Instrument Landing System Indications	10.11.16
Expanded Localizer Indications	10.11.18
PFD Radio Altitude Indications	10.11.18
Traffic Alert and Collision Avoidance Indications	10.11.19
GPWS Annunciations	10.11.20
PFD – Altitude Indications	10.11.21
Altitude Indications– General	10.11.21
PFD Barometric Indications	10.11.22
Landing Altitude/Minimums Indications	10.11.24
PFD – Vertical Speed Indications	10.11.26
Vertical Speed Indications – General	10.11.26
PFD - Heading and Track Indications	10.11.27
Heading and Track Indications– General	10.11.27
PFD Failure Flags	10.11.28
Additional Annunciations and Alerts	10.11.30
Displays Control Panel Annunciation	10.11.30
Display System Annunciations	10.11.31

Instrument Switch Annunciation	10.11.32
Airspeed Disagree Alert	10.11.33
Altitude Disagree Alert	10.11.34
Navigation Displays – MAP Mode	10.11.34
Expanded and Center MAP Modes	10.11.35
Navigation Displays – Approach Mode	10.11.37
Expanded and Center Approach Modes	10.11.37
Navigation Displays – VOR Mode	10.11.39
Expanded and Center VOR Modes	10.11.39
Navigation Displays – Plan Mode	10.11.41
Plan Mode	10.11.41
Navigation Displays – Advisory Messages	10.11.42
Navigation Advisory Messages	10.11.42
Mode/Frequency Disagree Annunciation	10.11.43
TCAS Messages	10.11.44
Look-Ahead Terrain Messages (GPWS)	10.11.45
Predictive Windshear System (PWS) Message	10.11.46
Navigation Displays – Failure Indications and Flags	10.11.47
Expanded MAP, Center MAP, Expanded APP, Expanded VOR Modes	10.11.47
ND Failure Flags – Center APP and Center VOR Modes	10.11.49
EFIS Instruments – Controls and Indicators	10.15.1
EFIS Control Panel (EFIS/Map Display)	10.15.1
EFIS Control Panel Controls – Flight Instrument Displays	10.15.1
EFIS Control Panel Controls – Navigation Displays	10.15.2
Displays Source Panel	10.15.5
Display Select Panels	10.15.6
Speed Reference Selector	10.15.7
Display Brightness Controls	10.15.8
Captain Brightness Controls	10.15.8
First Officer Brightness Controls	10.15.9

737 Flight Crew Operations Manual

Standby Flight Instruments	10.15.10
Standby Magnetic Compass	10.15.10
Integrated Standby Flight Display	10.15.11
Standby Radio Magnetic Indicator	10.15.15
Clock	10.15.16
Flight Recorder	10.15.18
EFIS Instruments (PFD) – Controls	10.16.1
EFIS Control Panel (PFD/ND Display)	10.16.1
EFIS Control Panel Controls – Flight Instrument Displays	10.16.1
EFIS Control Panel Controls – Navigation Displays	10.16.3
Displays Source Panel	10.16.5
Display Select Panels	10.16.6
Speed Reference Selector	10.16.7
Display Brightness Controls	10.16.8
Captain Brightness Controls	10.16.8
First Officer Brightness Controls	10.16.9
Standby Flight Instruments	10.16.10
Standby Magnetic Compass	10.16.10
Standby Attitude Indicator	10.16.11
Standby Altimeter/Airspeed Indicator	10.16.13
Integrated Standby Flight Display	10.16.14
Standby Radio Magnetic Indicator	10.16.19
Clock	10.16.20
Flight Recorder	10.16.24
EFIS/Map System Description	10.20.1
Introduction	10.20.1
Display Brightness Control	10.20.1
DISPLAYS SOURCE Panel	10.20.2
EFIS Control Panels	10.20.3
Display Select Panel	10.20.3



Display Selection and Control Examples	10.20.4
Normal Display Configuration	10.20.4
Display Unit Failure Automatic Switching	10.20.5
EFIS Control Panel	10.20.7
Outboard Display Switching	10.20.8
Inboard Display Switching	10.20.9
Lower Display Switching	10.20.11
Display System Information Sources	10.20.12
Air Data Inertial Reference System (ADIRS)	10.20.12
Standby Flight Instruments	10.20.13
Standby Magnetic Compass	10.20.13
Integrated Standby Flight Display (ISFD)	10.20.14
Standby Radio Magnetic Indicator	10.20.14
Clocks	10.20.15
Flight Recorder	10.20.15
Aircraft Condition Monitoring System (ACMS)	10.20.15
PFD/ND System Description	10.21.1
Introduction	10.21.1
Display Brightness Control	10.21.1
DISPLAYS SOURCE Panel	10.21.2
EFIS Control Panels	10.21.3
Display Select Panel	10.21.3
Display Selection and Control Examples	10.21.4
Normal Display Configuration	10.21.4
Display Unit Failure Automatic Switching	10.21.5
EFIS Control Panel	10.21.7
Outboard Display Switching	10.21.8
Inboard Display Switching	10.21.9
Lower Display Switching	10.21.11
Display System Information Sources	10.21.12
Air Data Inertial Reference System (ADIRS)	10.21.12

737 Flight Crew Operations Manual

Standby Flight Instruments	10.21.13
Standby Magnetic Compass	10.21.14
Standby Attitude Indicator	10.21.14
Integrated Standby Flight Display (ISFD)	10.21.14
Standby Altimeter/Airspeed Indicator	10.21.15
Standby Radio Magnetic Indicator	10.21.15
Clocks	10.21.15
Flight Recorder	10.21.15
Aircraft Condition Monitoring System (ACMS)	10.21.16
Electronic Flight Instrument System (EFIS)	10.30.1
Introduction	10.30.1
Airspeed	10.30.1
Attitude	10.30.1
Steering Indications	10.30.2
Instrument Landing System Indications	10.30.2
Approach Minimums	10.30.3
Heading Indications	10.30.3
Radio Altitude	10.30.3
Radio Altitude Alert	10.30.3
Altitude	10.30.3
Vertical Speed	10.30.4
Traffic Alert and Collision Avoidance (TCAS)	
Indications	10.30.4
GPWS Warnings	10.30.4
Primary Flight Display (PFD)	10.31.1
Introduction	10.31.1
Airspeed	10.31.1
Attitude	10.31.1
Steering Indications	10.31.2
Instrument Landing System Indications	10.31.2



Approach Minimums	10.31.3
Radio Altitude	10.31.3
Altitude	10.31.3
Vertical Speed	10.31.4
Heading/Track Indications	10.31.4
Traffic Alert and Collision Avoidance (TCAS) Indications	10.31.5
GPWS Warnings	10.31.5
Navigation Displays	10.40.1
Introduction	10.40.1
Horizontal Situation Indicator (HSI)	10.40.1
Radio Distance Magnetic Indicator (RDMI)	10.40.1
Navigation Display – MAP Mode	10.40.1
Navigation Data Points	10.40.1
VOR and Approach Modes	10.40.2
Plan Mode	10.40.2
Navigation Display Information	10.40.2
Heading	10.40.2
Track	10.40.2
Traffic	10.40.2
Weather Radar	10.40.2
Failure Flags and Messages	10.40.2
Navigation Display Symbology	10.40.3
Heading, Track, and Speed	10.40.3
Radio Navigation	10.40.4
MAP	10.40.6
Look-Ahead Terrain	10.40.12
Predictive Windshear	10.40.13
TCAS	10.40.14
PFD/ND Navigation Displays	10.41.1
Introduction	10.41.1

737 Flight Crew Operations Manual

Map Mode	10.41.1
Navigation Data Points	10.41.1
VOR and Approach Modes	10.41.1
Plan Mode	10.41.1
ND Information	10.41.2
Heading	10.41.2
Track	10.41.2
Traffic	10.41.2
Weather Radar	10.41.2
Failure Flags and Messages	10.41.2
ND Symbology	10.41.3
Heading, Track, and Speed	10.41.3
Radio Navigation	10.41.5
Map	10.41.8
Look-Ahead Terrain	10.41.13
Predictive Windshear	10.41.14
TCAS	10.41.15



Intentionally
Blank

This Section Applies to YA371, YA372, YC201

EFIS/Map Display System – Overview

Display Units

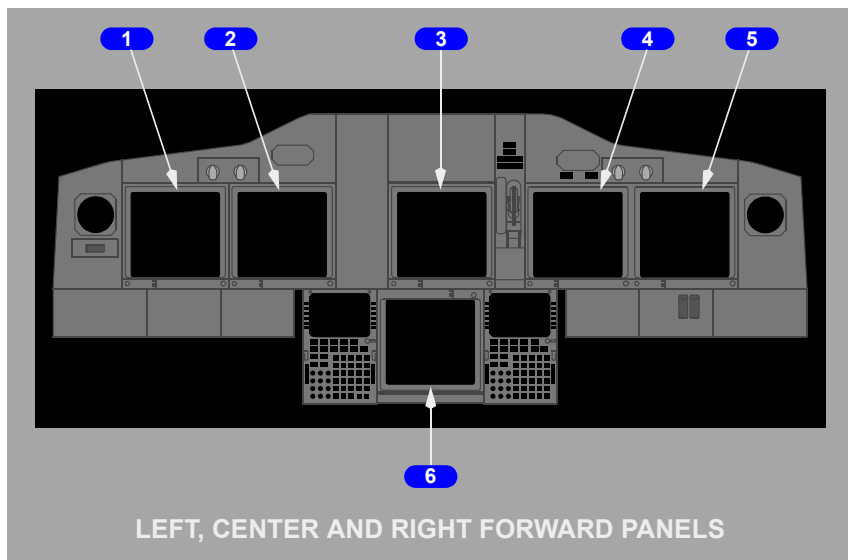

- 1** Captain Outboard Display Unit
- 2** Captain Inboard Display Unit
- 3** Upper Display Unit
- 4** First Officer Inboard Display Unit
- 5** First Officer Outboard Display Unit
- 6** Lower Display Unit

Captain Outboard Display

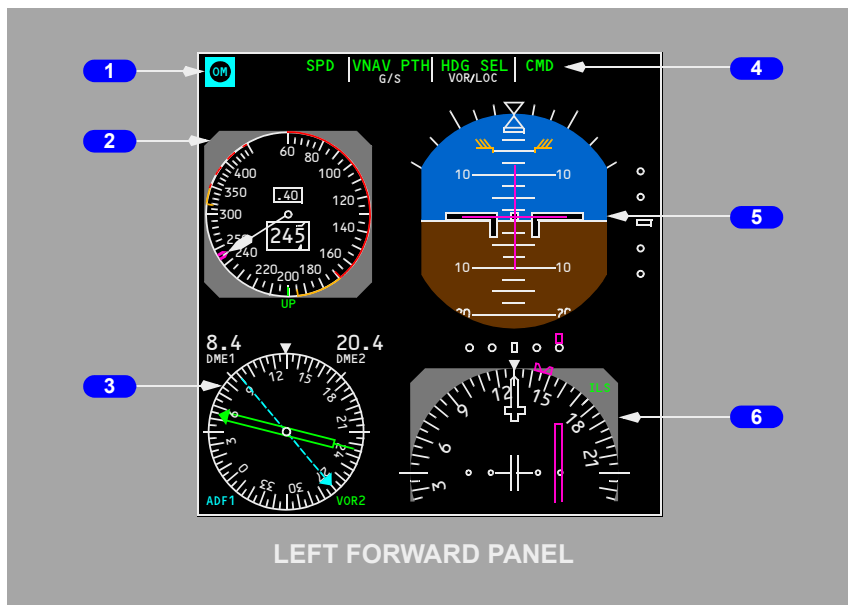

- 1** Marker Beacon
- 2** Mach/Airspeed Indicator
- 3** Radio Distance Magnetic Indicator
- 4** Flight Mode Annunciations
Refer to Chapter 4, Automatic Flight
- 5** Attitude Indicator
- 6** Horizontal Situation Indicator

Captain Inboard Display

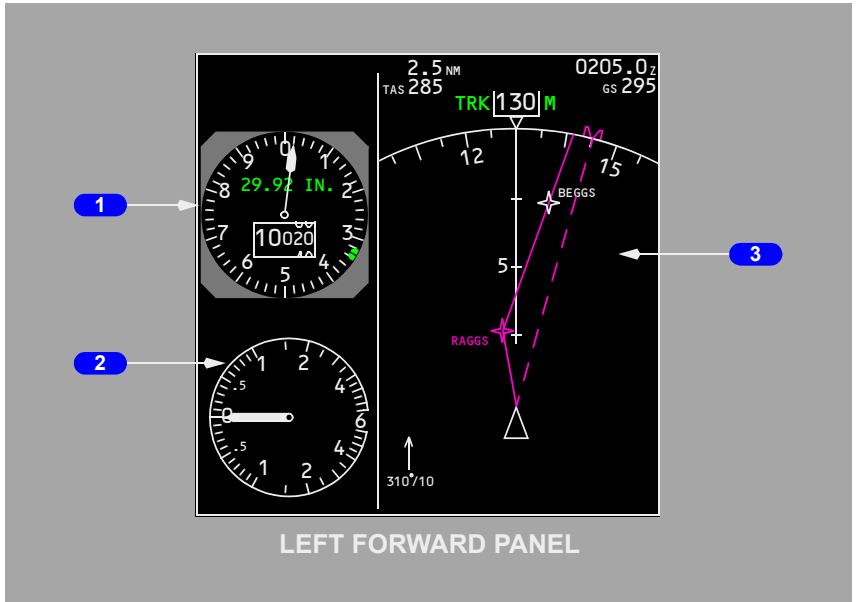

1 Altimeter

2 Vertical Speed Indicator

3 Navigation Display

Displays approach, VOR, moving map, or static map as selected on the EFIS control panel.

First Officer Inboard Display

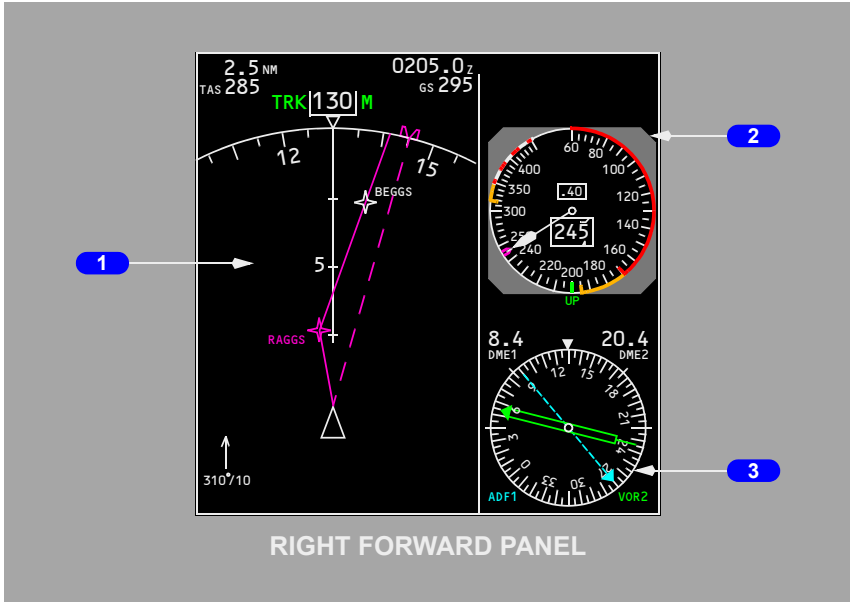

1 Navigation Display

Displays approach, VOR, moving map, or static map as selected on the EFIS control panel.

2 Mach/Airspeed Indicator

3 Radio Distance Magnetic Indicator

First Officer Outboard Display

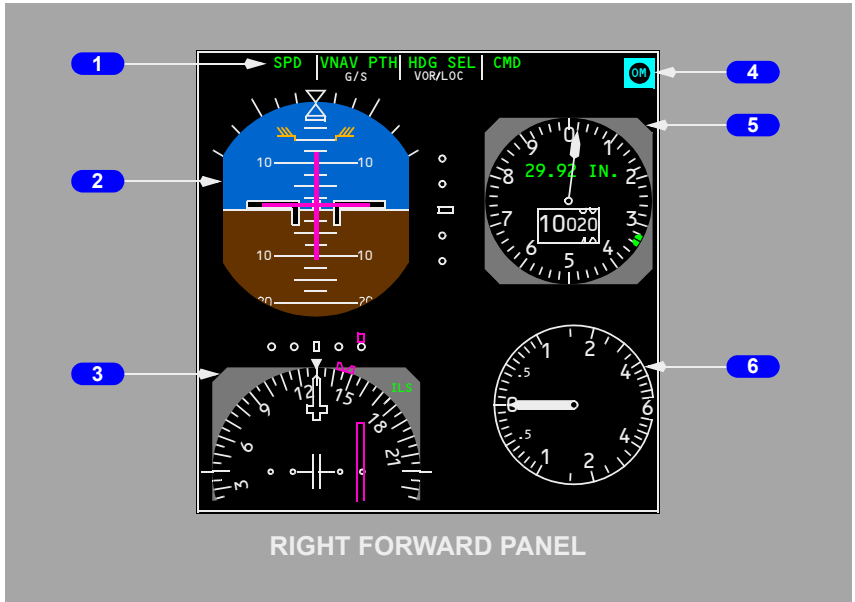

1 Flight Mode Annunciations

Refer to Chapter 4, Automatic Flight

2 Attitude Indicator

3 Horizontal Situation Indicator

4 Marker Beacon

5 Altimeter

6 Vertical Speed Indicator

Compact EFIS Format

The compact EFIS format is displayed automatically upon failure of either an inboard or an outboard display unit. The compact format can also be selected manually with the MAIN PANEL DUs selectors on the display select panel.

In the compact format, a full rose HSI is displayed. Other displays are about 25% smaller than normal.

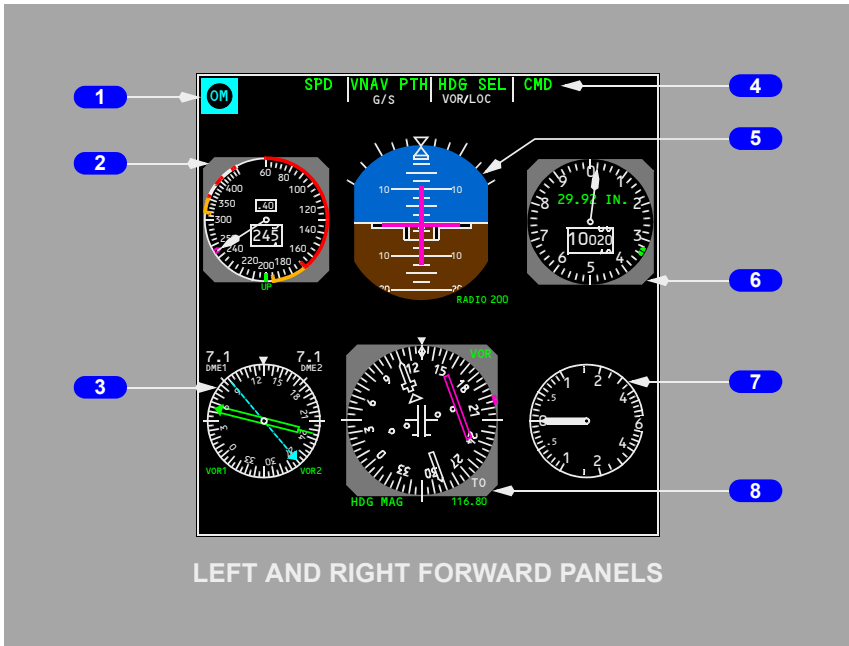

- 1 Marker Beacon
- 2 Mach/Airspeed Indicator
- 3 Radio Distance Magnetic Indicator
- 4 Flight Mode Annunciations
- 5 Attitude Indicator
- 6 Altimeter

7 Vertical Speed Indicator
8 Horizontal Situation Indicator
**Electronic Flight Instrument System (EFIS) –
 Mach/Airspeed Indicator (MASI)**
Mach/Airspeed Indicator – General

The mach/airspeed indicator displays air data inertial reference system (ADIRS) airspeed and other airspeed related information.

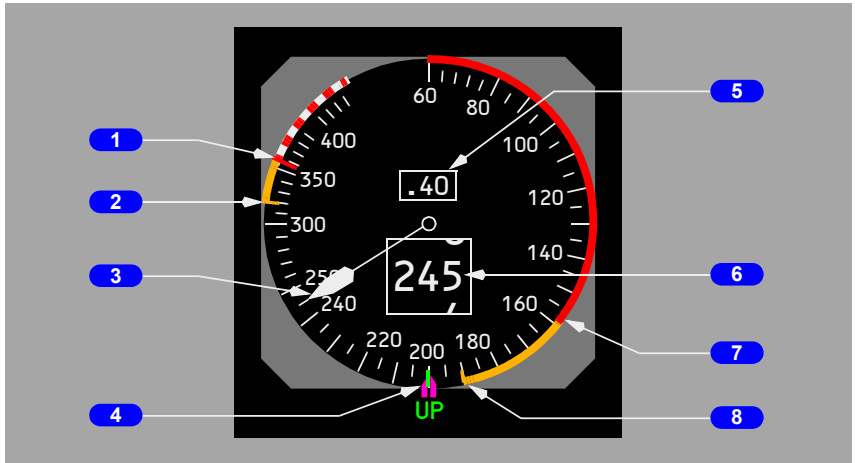
1 Maximum Operating Speed (red and white)

Start of the arc indicates the maximum speed as limited by the lowest of the following:

- V_{mo}/M_{mo}
- landing gear placard speed
- flap placard speed.

2 High Speed Buffet/Flap Extension Speed (amber)

At high altitudes and flaps up, the start of the arc indicates the airspeed that provides a 0.3 g maneuver margin to high speed buffet.

When flaps are not up, the start of the arc indicates flap extension placard speed for the next normal flap setting. The arc is removed when the flaps reach the landing flap selected on the APPROACH REF page or when the flaps reach flaps 40.

3 **Airspeed Pointer (white)**

Indicates current calibrated airspeed in knots.

4 **Airspeed Cursor (magenta)**

Displays target airspeed:

- indicates the airspeed manually selected in the IAS/MACH window
- indicates the FMC computed airspeed when the IAS/MACH window is blank.

5 **Mach Digital Counter (white)**

Indicates current Mach number:

- displays when airspeed increases above 0.40 Mach
- blanks when airspeed decreases below 0.38 Mach.

6 **Airspeed Digital Counter (white)**

Indicates current calibrated airspeed in knots.

7 **Stick Shaker Speed (red)**

Red index mark indicates the speed at which stick shaker occurs.

8 **Minimum Maneuver Speed (amber)**

Amber index mark indicates minimum maneuver speed.

Inhibited on takeoff until first flap retraction or valid VREF entered.

Mach/Airspeed Indicator – Takeoff

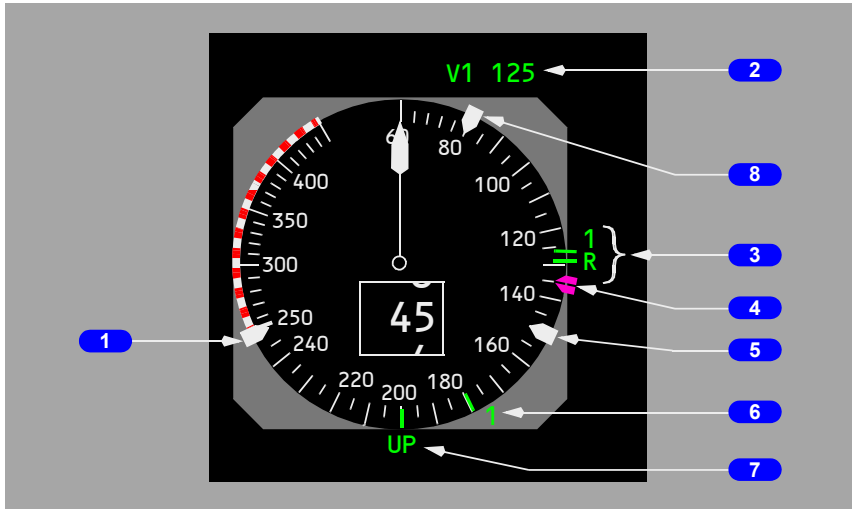

1 Bug 5 (white)

Displayed if the speed reference selector on the engine display control panel is in the bug 5 position and a value greater than 60 knots has been selected. Not available if the speed reference selector is in the AUTO position.

2 Speed Reference Display (green)

Displayed if the airspeed and/or weight is entered via the speed reference selector on the engine display control panel:

- on the ground, V1, VR, and takeoff gross weight may be selected; if VREF is selected, INVALID ENTRY is displayed
- in flight, VREF and landing gross weight may be selected; if V1 or VR is selected, INVALID ENTRY is displayed
- removed when the speed reference selector is moved to the SET position.

3 Takeoff Reference Speeds (green)

Indicates V1 (decision speed) and VR (rotation speed) as selected on the CDU TAKEOFF REF page (refer to Chapter 11, Flight Management, Navigation) or as set with the speed reference selector on the engine display control panel:

- amber NO VSPD flag is displayed on the ground if V1 or VR is not selected on the CDU or is not set with the speed reference selector
- displayed for takeoff when speed is greater than 80 knots
- removed at lift-off.

4 Airspeed Cursor (magenta)

Set with the speed selector on the mode control panel.

5 V2+15 (white)

Displayed for takeoff.

Removed when either of the following occurs:

- at first flap retraction
- when VREF is entered.

6 Flap Maneuvering Speed (green)

Indicates flap maneuvering speed for the displayed flap position:

- when the V2+15 bug is displayed for takeoff, the flap maneuvering speed bug for the current flap setting is not displayed except for a flaps 1 takeoff
- flap bugs inhibited if less than VREF +4.

7 Flaps Up Airspeed (green)

Displayed after zero fuel weight is entered in the CDU and takeoff gross weight is calculated, or after takeoff gross weight is set with the speed reference selector.

Not displayed above approximately 20,000 feet altitude.

8 80 Knots Airspeed Bug (white)

Indicates 80 knots:

- displayed automatically during preflight
- removed at first flap retraction or when VREF is entered.

Mach/Airspeed Indicator – Approach

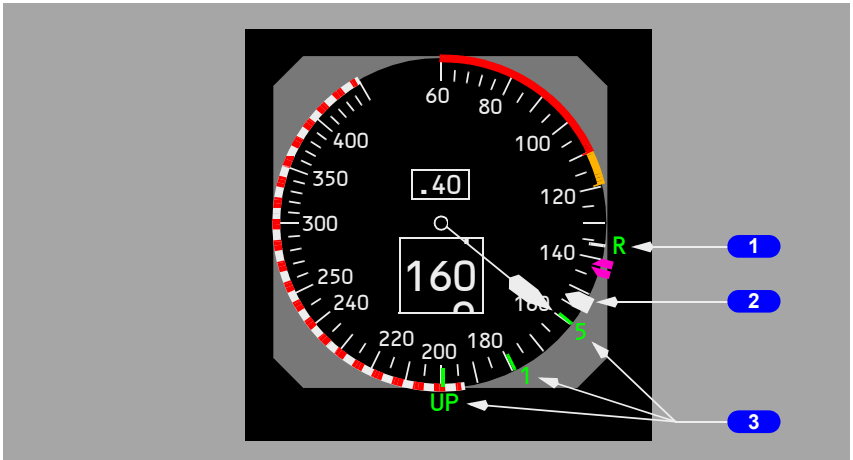

1 Landing Reference Speed (green)

Indicates VREF (reference speed) as selected on the CDU APPROACH REF page (refer to Chapter 11, Flight Management, Navigation) or as set with the speed reference selector on the engine display control panel.

2 VREF+15 (white)

Displayed after selection of VREF.

3 Flap Maneuvering Speeds (green)

Indicate flap maneuvering speeds for the displayed flap position:

- not shown if less than or equal to VREF+4
- numbered flap maneuvering speed bugs are removed when the flap lever is moved to flaps 30 or 40.

Mach/Airspeed Indicator – IAS Disagree Alert

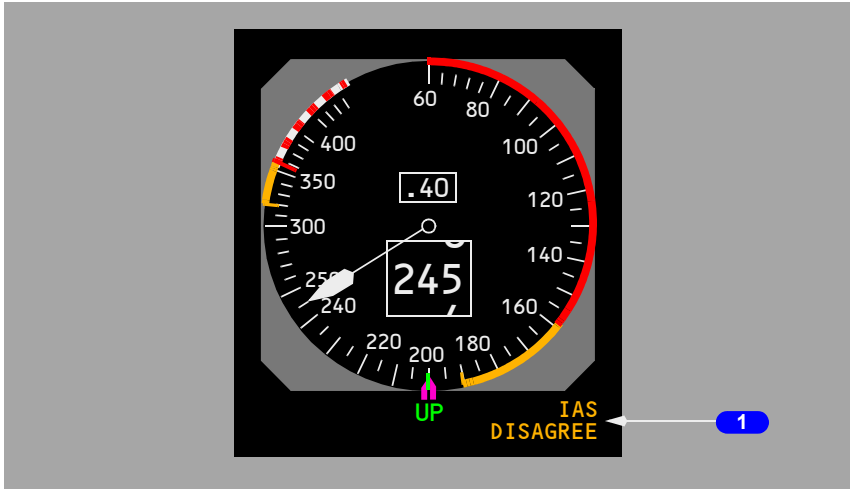

1 Airspeed Disagree Alert (amber)

Indicates the Captain's and F/O's airspeed indications disagree by more than 5 knots for 5 continuous seconds.

Mach/Airspeed Indicator Failure Flags

The flag replaces the appropriate display to indicate source system failure or lack of computed information.

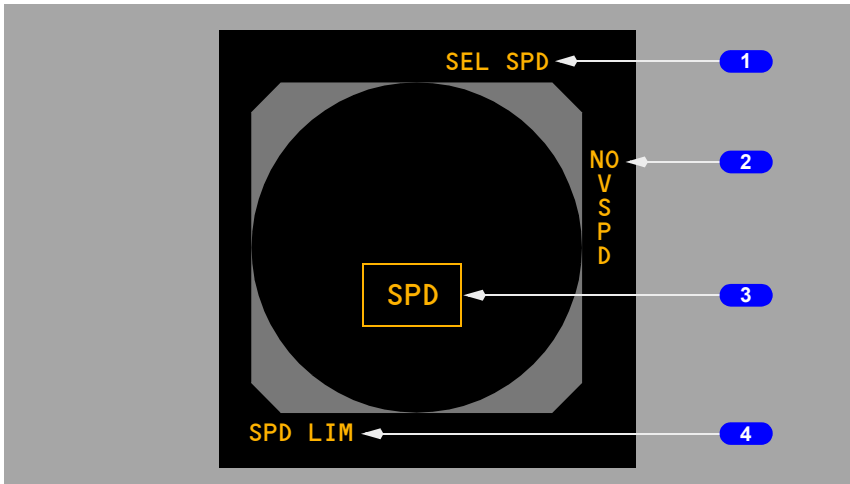

1 Selected Speed Flag (amber)

The airspeed cursor is inoperative. The airspeed cursor is removed.

2 No VSPD Flag (amber)

V1 (decision speed) or VR (rotation speed) has not been entered or is invalid.

3 Speed Flag (amber)

The Mach/airspeed indicator is inoperative. All indicator markings are removed.

4 Speed Limit Flag (amber)

Displays related with stick shaker or maximum operating speed has failed:

- if the stick shaker warning has failed, the red stick shaker speed arc is removed
- if the maximum operating speed has failed, the red and white maximum operating speed arc is removed.

EFIS – Attitude Indicator

Attitude Indicator – General

The attitude indicator displays ADIRS attitude information.

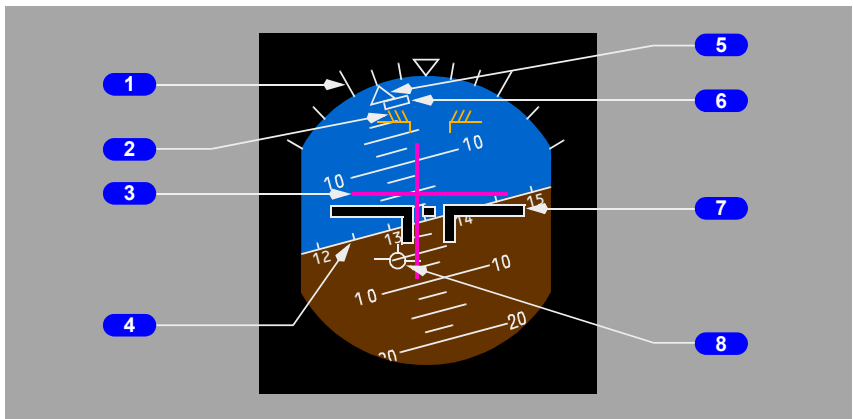

1 Bank Scale (white)

Provides fixed reference for the bank pointer; scale marks are at 0, 10, 20, 30, 45, and 60 degrees.

2 Pitch Limit Indicator (amber)

Indicates pitch limit (stick shaker activation for existing flight conditions).

- displayed when flaps are not up
- displayed at slow speed with flaps up

3 Flight Director (magenta)

Indicates flight director steering commands. (Refer to Chapter 4, Automatic Flight.)

4 Horizon Line and Pitch Scale (white)

Indicates the horizon relative to the airplane symbol; pitch scale is in 2.5 degree increments.

Horizon scale is in 5 degree increments.

5 Bank Pointer

Indicates bank angle; fills and turns amber if bank angle is 35 degrees or more.

6 Slip/Skid Indication

Displaces beneath the bank pointer to indicate slip or skid:

- fills white at full scale deflection
- turns amber if bank angle is 35 degrees or more; fills amber if the slip/skid indicator is also at full scale deflection.

7 Airplane Symbol

Indicates airplane attitude relative to the horizon.

8 Flight Path Vector (FPV) Indication (white)

Displays flight path angle and drift when selected on the EFIS control panel:

- flight path angle is displayed relative to the horizon line
- drift angle is displayed relative to display center.

Attitude Indicator – Navigation Performance Scales (NPS) Indicators

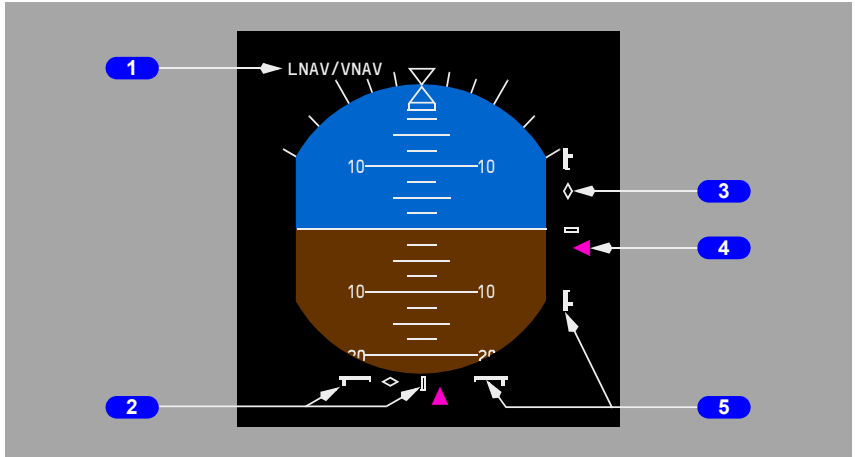

1 Scale ID Annunciation (white)

- displayed when LNAV or VNAV are engaged.
- displayed above the left corner of ADI.
- indicates source of displayed deviation for each scale.
- Possible annunciations include:
 - LNAV/VNAV - (LNAV and VNAV deviations)
 - LOC/VNAV - (Localizer with VNAV deviation)
 - LNAV/G/S - (LNAV deviation with glideslope)
 - ILS - (ILS approach)

2 NPS Deviation Scale

- lateral NPS deviation scale represents current FMC lateral RNP.
- vertical NPS deviation scale represents default RNP values.
- displayed if an approach mode is not engaged and either LNAV or any VNAV mode is engaged.

3 Anticipation Cues

- displayed if valid approach course deviation information is being received while corresponding NPS deviation scale and pointer are displayed.
- an unfilled white diamond symbol.

- if engaged lateral mode subsequently transitions to LOC, lateral NPS deviation indications will be removed, and normal ILS localizer indications will be displayed.
- if engaged vertical mode subsequently transitions to G/S, vertical NPS deviation indications will be removed, and normal ILS G/S indications will be displayed.

4 NPS Pointer

- a filled magenta symbol when it is not parked at deflection limit.
- an unfilled pointer outline when at deflection limit.
- indicates lateral/vertical paths relative to the airplane.
- will flash for 10 seconds if deviation is within ANP bar limits for 10 continuous seconds.

5 Actual Navigation Performance (ANP) Bars

- lateral/vertical indication of available flight technical error remaining based on total system error.
- lateral ANP bars can be displayed in all phases of flight.
- vertical ANP bars can be displayed only after reaching top-of-descent.
- originate from outer scale and expand inward as a function of increasing ANP relative to RNP.
- will just touch at center of scale when ANP equals RNP.
- turn from white to amber if current deviation is within ANP bar limits for 10 continuous seconds.

Attitude Indicator – Instrument Landing System Indications

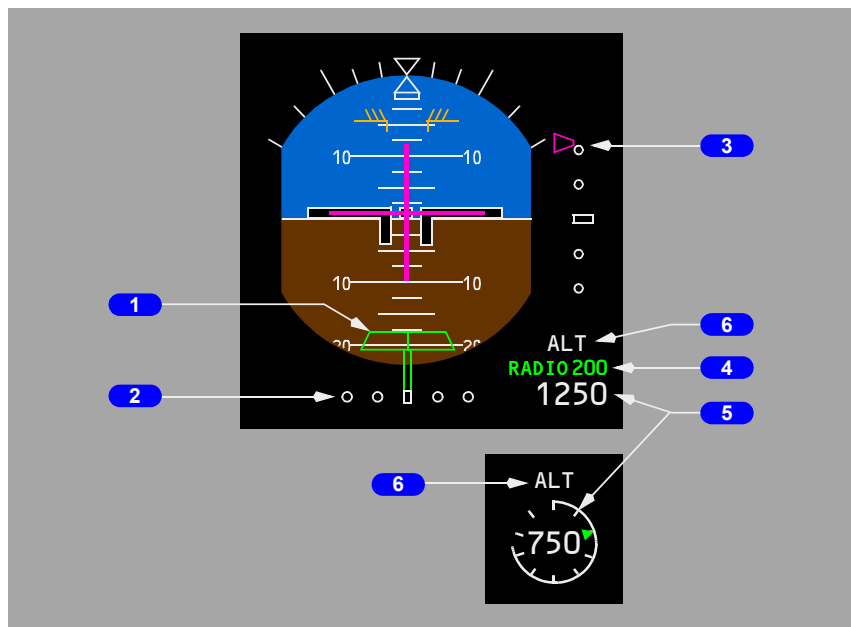

1 Rising Runway (green)

- displayed when localizer pointer is in view and radio altitude is less than 2500 feet
- rises towards airplane symbol when radio altitude is below 200 feet
- is not displayed when the localizer signal is unusable.

2 Localizer Pointer and Deviation Scale

The pointer:

- indicates localizer position relative to the airplane.
- in view when the localizer signal is received.

The scale:

- indicates deviation.
- expands when the localizer is engaged and deviation is slightly more than one-half dot.
- in view when the localizer signal is tuned.

At low radio altitudes, with autopilot engaged, the scale turns amber and the pointer flashes to indicate excessive localizer deviation.

Each pilot's deviation alerting system self-tests upon becoming armed at 1500 feet radio altitude. This self-test generates a two second LOC deviation alerting display on each attitude indicator.

3 Glide Slope Pointer and Deviation Scale

The pointer:

- indicates glide slope position.
- in view when the glide slope signal is received.
- the pointer is not displayed when the track and the front course on the mode control panel differ by more than 90 degrees (backcourse).

The scale:

- indicates deviation
- in view when the localizer signal is tuned.

At low radio altitudes, with autopilot engaged, the scale turns amber and the pointer flashes to indicate excessive glide slope deviation.

Each pilot's deviation alerting system self-tests upon becoming armed at 1500 feet radio altitude. This self-test generates a two second G/S deviation alerting display on each attitude indicator.

4 Selected Radio Altitude Approach Minimums (green)

- displays selected minimums as set on the EFIS control panel
- blank when an altitude less than 0 feet is selected
- "RADIO" legend and readout turn amber and flash for 3 seconds when descending through the selected minimum altitude; the legend and readout become steady amber after 3 seconds
- changes back to green:
 - when passing the selected minimum altitude plus 75 feet during go-around
 - at touchdown
 - after pressing the RST switch on the EFIS control panel.

5 Radio Altitude (display –white, selected radio altitude pointer–green)

- displayed below 2500 feet AGL
- blanked above 2500 feet AGL
- digital display from 2500 to 1000 feet AGL
- round dial display below 1000 feet AGL:
 - pointer replaces digital display of selected radio minimum altitude
 - the circumference of the dial is added to, or taken away from, to depict the airplane's radio altitude

737 Flight Crew Operations Manual

- dial and readout turn amber and dial flashes for 3 seconds when descending through the selected minimum altitude; the dial becomes steady amber after 3 seconds
- changes back to white:
 - when passing through the selected minimum altitude plus 75 feet during go-around
 - at touchdown
 - after pressing the RST switch on the EFIS control panel.

6 Radio Altitude Height Alert (white)

Displayed when radio altitude is less than or equal to 1500 feet. Blanked when descent continues below 500 feet AGL, or after pressing the RST switch on the EFIS control panel.

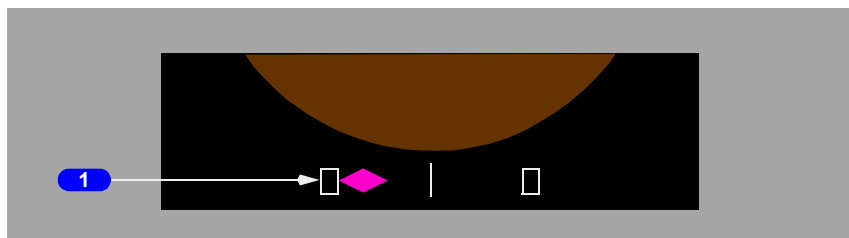
Expanded Localizer Indications

1 Expanded Localizer Scale

Displayed when the autopilot or flight director is in LOC mode, deviation is slightly more than one half dot and track is within 5 degrees of the MCP selected course.

Reverts to standard scale when out of LOC mode, and groundspeed is less than 30 knots or radio altitude is greater than 200 feet.

A rectangle equals 1/2 dot deviation.

Attitude Indicator Failure Flags

Flags replace the attitude displays to indicate source system failure or lack of computed information.

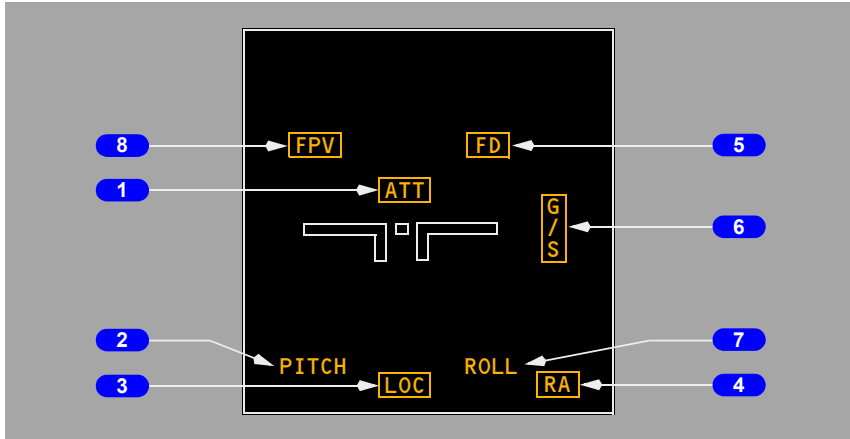

1 Attitude Flag (amber)

The attitude display has failed.

2 Pitch Flag (amber)

The Captain and First Officer pitch angle displays differ by more than 5 degrees. The flag flashes for 10 seconds then remains steady.

3 Localizer Flag (amber)

An ILS frequency is tuned and the ILS localizer deviation display on the attitude indicator has failed.

4 Radio Altitude Flag (amber)

The radio altitude display has failed.

5 Flight Director Flag (amber)

The flight director has failed.

6 Glide Slope Flag (amber)

An ILS frequency is tuned and the ILS glide slope deviation display on the attitude indicator has failed.

7 Roll Flag (amber)

The Captain and First Officer roll displays differ by more than 5 degrees.
The flag flashes for 10 seconds then remains steady.

8 Flight Path Vector Flag (amber)

FPV is selected on the EFIS control panel, but has failed. De-selection of FPV removes the flag.

Traffic Alert and Collision Avoidance Indications

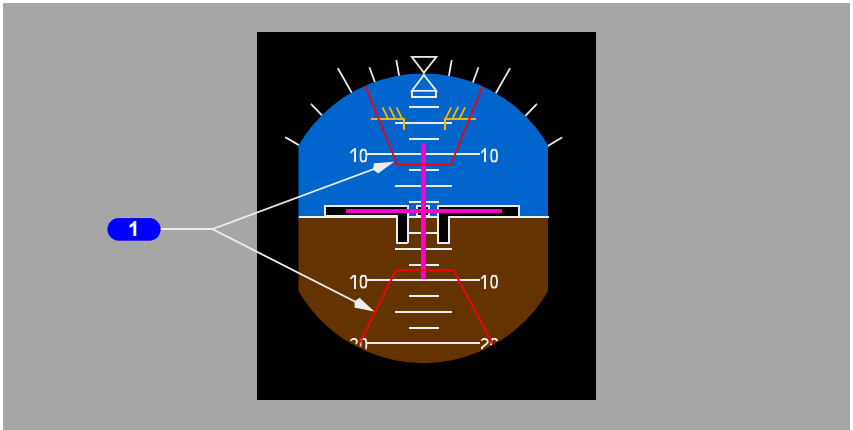

1 Traffic Alert and Collision Avoidance System Pitch Command (red)

The area(s) inside the red lines indicate(s) the pitch region(s) to avoid in order to resolve the traffic conflict. The airplane symbol must be outside the TCAS pitch command area(s) to ensure traffic avoidance. Refer to Chapter 15, Warning Systems.

GPWS Annunciations

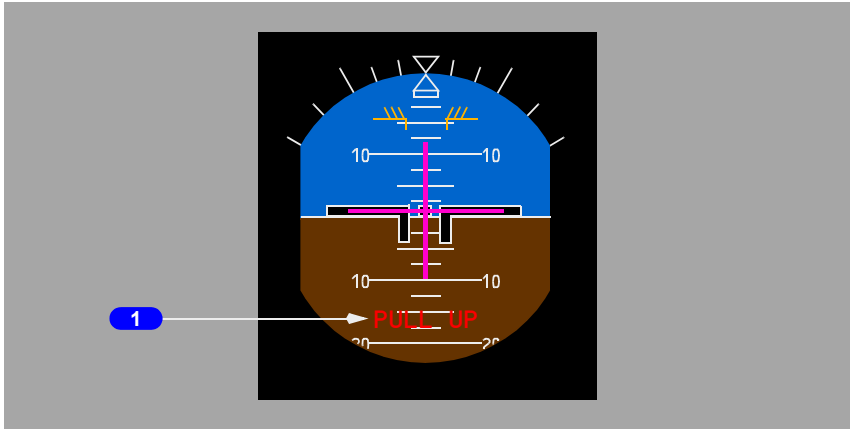

1 GPWS Annunciations (red)

Refer to Chapter 15, Warning Systems.

EFIS – Altimeter

Altimeter – General

The altimeter displays ADIRS altitude and other altitude related information.



1 Altitude Pointer

Makes one revolution each one thousand feet.

2 Reference Altitude Marker (green)

Indicates the barometric minimums as set by the minimums selector on the EFIS control panel.

The minimums reference selector must be in the BARO position to adjust the reference altitude marker.

Color:

- turns amber when descending through the selected minimum altitude
- changes back to green after pushing the RST switch on the EFIS control panel.

3 Altitude Alert Annunciation (amber)

- appears steady for altitude acquisition
- flashes during altitude deviation
- refer to Chapter 15, Warning Systems.

4 Metric Selected Altitude Readout (readout–magenta, caption–cyan)

Displays MCP altitude in meters when MTRS is selected on the EFIS control panel. Not available in compact mode.

5 Barometric Setting (green)

Indicates the barometric setting in either inches of mercury (IN) or hectopascals (HPA) as selected on the EFIS control panel.

6 Metric Digital Readout (readout–white, caption–cyan)

Displays current altitude in meters when MTRS is selected on the EFIS control panel. Not available in compact mode.

7 Digital Readout (white)

Displays current altitude in increments of thousands, hundreds and twenty feet:

- for positive values of altitude below 10,000 feet, a green crosshatch symbol is displayed
- a negative sign appears when altitude below zero feet is displayed.

8 Selected Minimums Barometric Readout (Green)

Indicates the barometric minimums as set by the minimums selector on the EFIS control panel:

- turns amber and flashes when descending through the selected minimum altitude
- changes back to green after pressing the RST switch on the EFIS control panel
- pressing the RST switch when above the selected altitude removes the readout.

Altimeter – Altitude Disagree Alert



1 Altitude Disagree Alert (amber)

Indicates the Captain's and F/O's altitude indications disagree by more than 200 feet for more than 5 continuous seconds.

Altimeter Failure Flag

The failure flag replaces the altitude displays to indicate system failure.

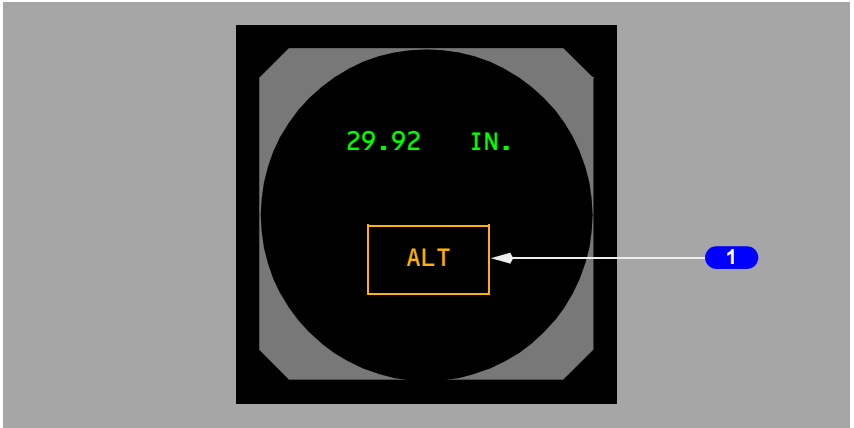

1 Altitude Failure Flag (amber)

The barometric altitude or barometric correction has failed:

- all altimeter symbols are removed except the ALT ALERT annunciation and the barometric setting.

EFIS – Vertical Speed Indicator

Vertical Speed Indicator – General

The vertical speed indicator displays ADIRS instantaneous vertical speed.

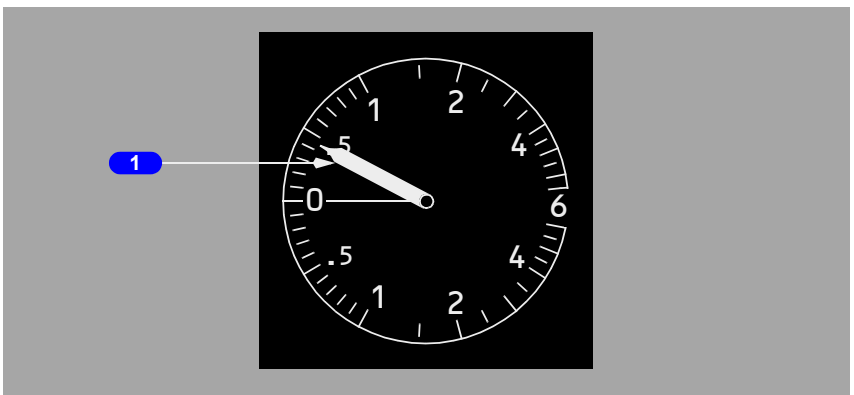

1 Vertical Speed Pointer (white)

Depicts rate of climb or descent from 0 to 6000 feet per minute.

Vertical Speed Indicator Failure Flag

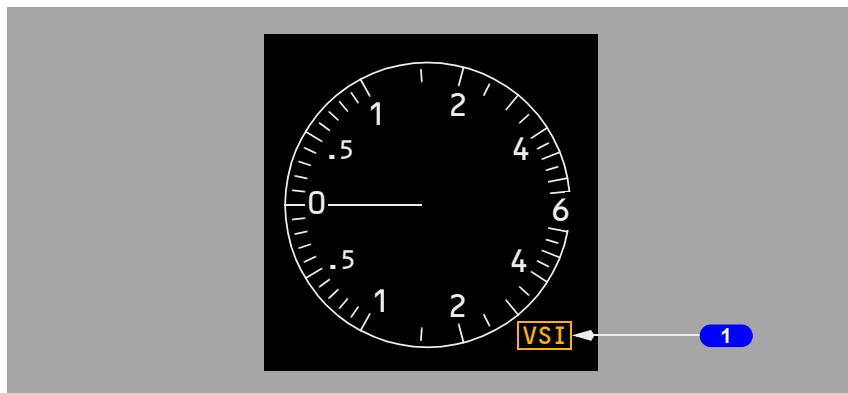

1 VSI Failure Flag (amber)

Vertical speed has failed. The pointer is also removed.

EFIS – Marker Beacon Indications

Marker Beacons Indications

The marker beacon indication flashes when over one of the marker beacon transmitters.

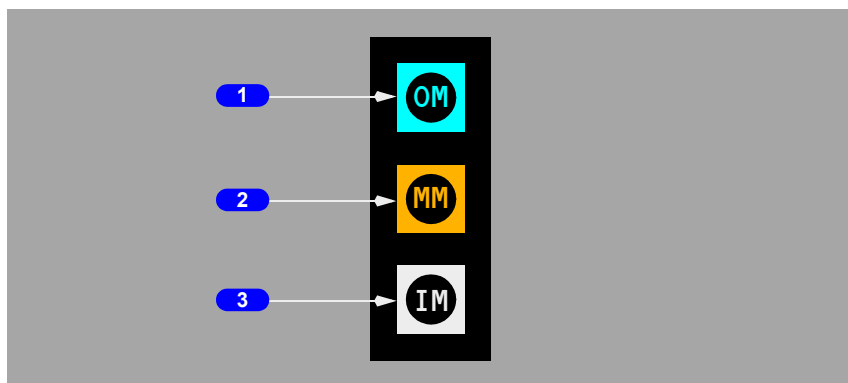

1 Outer Marker (cyan)

Flashes when over an outer marker beacon.

2 Middle Marker (amber)

Flashes when over a middle marker beacon.

3 Inner Marker (white)

Flashes when over an inner marker beacon.

Navigation Displays – Horizontal Situation Indicator (HSI)

Horizontal Situation Indicator – General

The HSI displays current ADIRS heading, track and other information.

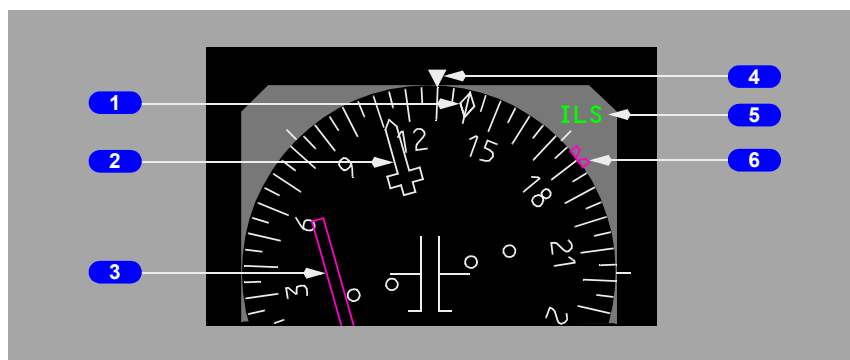
1 Drift Angle Pointer (white)

Indicates current drift angle or track.

2 Selected Course Pointer (white)

Indicates the course set on the mode control panel. Set by the related mode control panel course selector.

3 Course Deviation Indicator (magenta)

Indicates deviation from the selected localizer or VOR course.

4 Heading Pointer (white)

Indicates current heading.

5 Lateral Deviation Source Annunciation (green)

Identifies the selected navigation source as VOR or ILS.

6 Selected Heading Bug (magenta)

Indicates the heading selected on the mode control panel. If the selected heading exceeds the display range, the bug parks on the side of the compass rose in the direction of the shorter turn to the heading.

Horizontal Situation Indicator – Compact Display

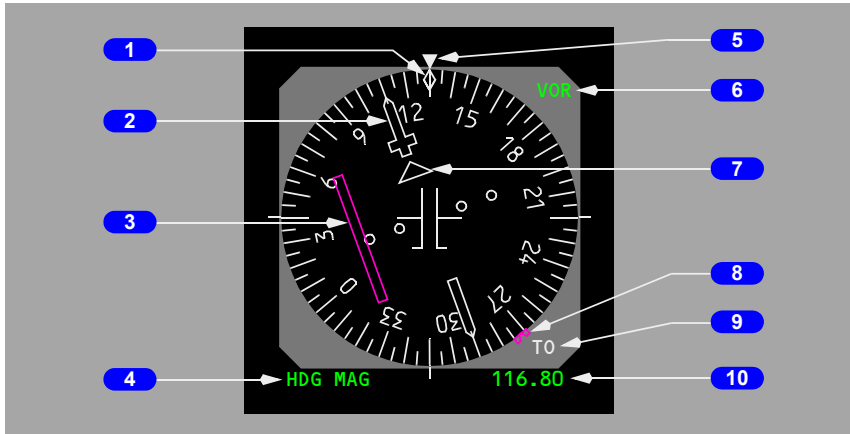

1 Drift Angle Pointer (white)

Indicates current drift angle or track.

2 Selected Course Pointer (white)

Indicates the course set on the mode control panel. Set by the related mode control panel course selector.

3 Course Deviation Indicator (magenta)

Indicates deviation from the selected localizer or VOR course.

4 Magnetic/True Heading Annunciation (green)

Indicates the HSI reference:

- HDG MAG (green) indicates display is oriented relative to magnetic north
- TRU HDG (green) indicates display is oriented relative to true north; a white box is displayed continuously around TRU HDG

737 Flight Crew Operations Manual

- transition from TRU HDG to HDG MAG results in a green box around HDG MAG for 10 seconds
- when TRU HDG is displayed and the airplane descends more than 2000 feet at a descent rate greater than –800 feet per minute, an amber box is drawn around TRU HDG; the box flashes for 10 seconds, then turns steady amber.

5 Heading Pointer (white)

Indicates current heading.

6 Lateral Deviation Source Annunciation (green)

Identifies the selected navigation source as VOR or ILS.

7 TO/FROM Pointer (white)**8 Selected Heading Bug (magenta)**

Indicates the heading selected on the mode control panel.

9 TO/FROM Annunciation (white)**10 Frequency Display (green)**

Indicates selected navigation radio frequency.

Horizontal Situation Indicator Failure Flags

The flags replace the horizontal situation indicator displays to indicate source system failure or lack of computed data.

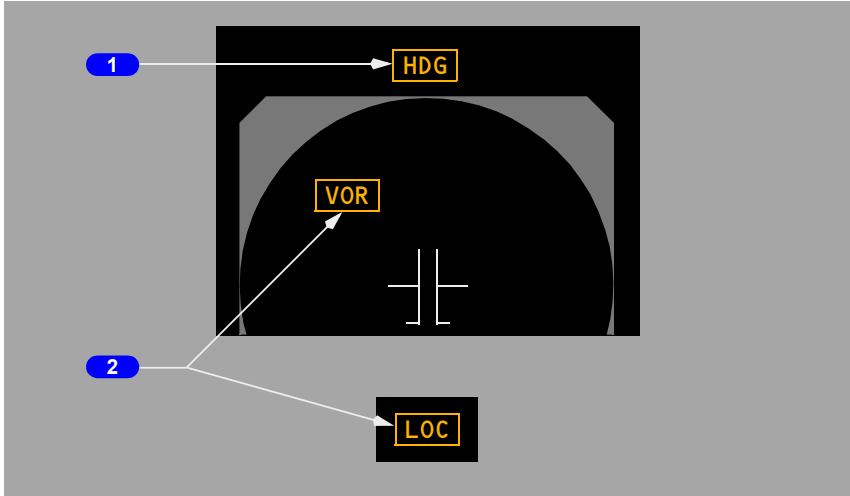

1 Heading Failure Flag (amber)

The heading source has failed. The compass rose is removed.

2 VOR/LOC Failure Flag (amber)

The airplane navigation data source has failed.

Navigation Displays – Radio Distance Magnetic Indicator (RDMI)

Radio Distance Magnetic Indicator – General

The RDMI provides the same information as a conventional RDMI.



1 DME Indications (white)

Displayed if DME information is available from the navigation aid tuned in the VHF navigation control panel.

2 Bearing Pointers (VOR source–green, ADF source–cyan)

- narrow pointer uses signals from the VHF NAV receiver No. 1 or ADF receiver No. 1
- wide pointer uses signals from the VHF NAV receiver No. 2.

3 Bearing Source Indications (VOR source–green, ADF source–cyan)

- indicates “OFF” (white) if related VOR/ADF switch on the EFIS control panel is in the OFF position
- bearing source indicator No. 2 displays “INOP” (white) if the No. 2 VOR/ADF switch is in the ADF position.

Radio Distance Magnetic Indicator Failure Flags

The flags replace the RDMI displays to indicate source system failure.

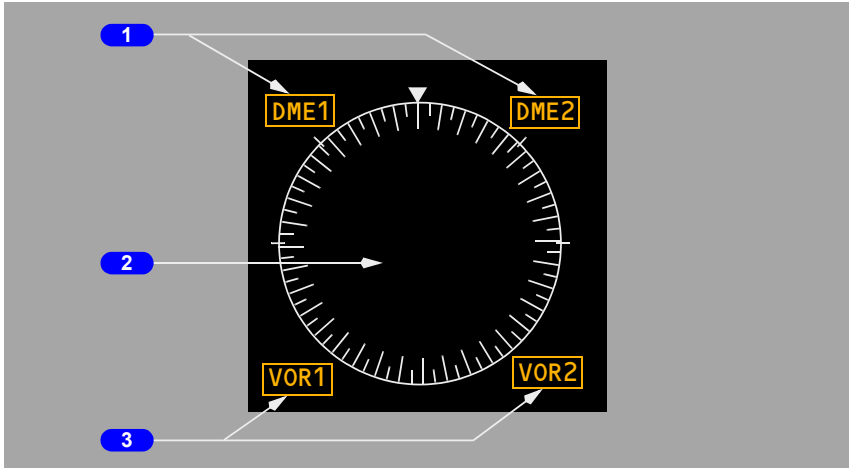

1 DME Failure Flags (amber)

The DME system has failed.

2 Heading Failure

The heading display is removed if heading information has failed.

3 VOR, ADF Failure Flags (amber)

The selected VOR or ADF information is invalid.

Navigation Displays – MAP Mode

Note: Refer to section 40 of this chapter for a detailed explanation of the navigation symbology shown on the following pages.

Expanded MAP Mode

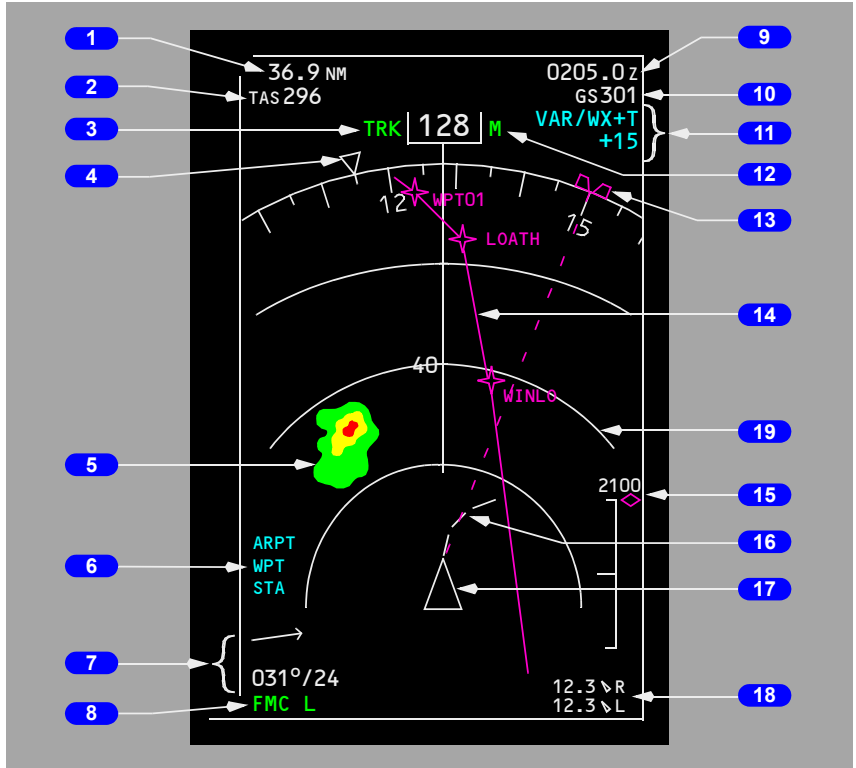

- 1** Distance to Next Active Waypoint
- 2** True Airspeed
- 3** Current Track
- 4** Heading Pointer
- 5** Weather Radar Returns
- 6** MAP Options

- 7** Wind Direction and Speed
- 8** MAP Source Annunciation
- 9** Estimated Time of Arrival at Next Active Waypoint
- 10** Groundspeed
- 11** Weather Radar Annunciations
- 12** Magnetic/True Reference
- 13** Selected Heading Bug
- 14** Active LNAV Route
- 15** Vertical Deviation Scale and Pointer
- 16** Position Trend Vector
- 17** Airplane Symbol
- 18** Position Difference Display
- 19** Weather Range Arcs

Center MAP Mode

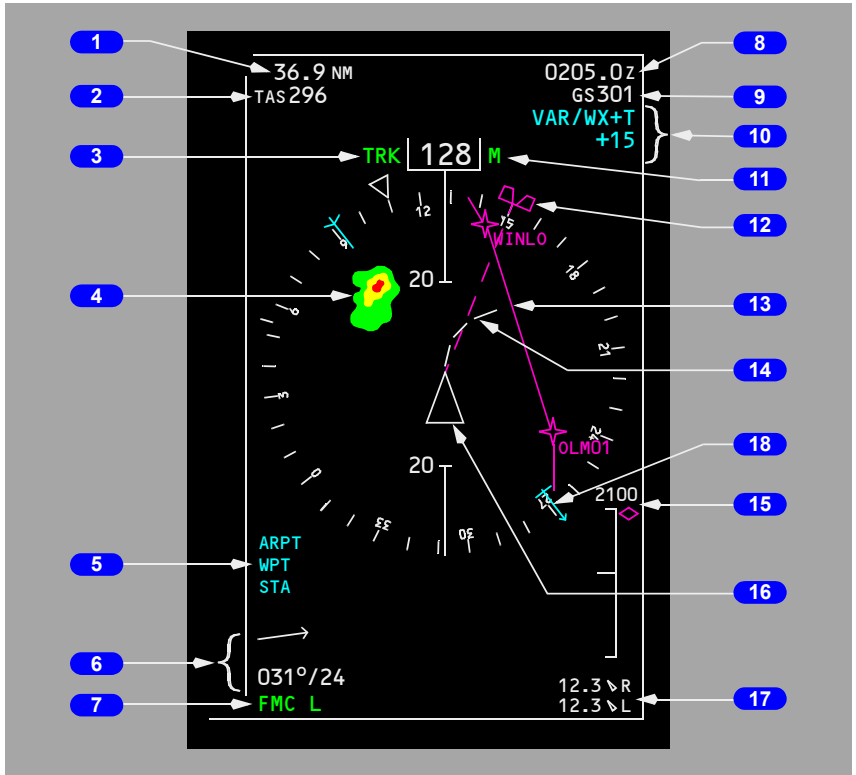

- 1 Distance to Next Active Waypoint
- 2 True Airspeed
- 3 Current Track
- 4 Weather Radar Returns
- 5 MAP Options
- 6 Wind Direction and Speed
- 7 MAP Source Annunciation
- 8 Estimated Time of Arrival at Next Active Waypoint

- 9** Groundspeed
- 10** Weather Radar Annunciations
- 11** Magnetic/True Reference
- 12** Selected Heading Bug
- 13** Active Route
- 14** Position Trend Vector
- 15** Vertical Deviation Scale and Pointer
- 16** Airplane Symbol
- 17** Position Difference Display
- 18** ADF1 Bearing Pointer

Navigation Displays – Approach Mode

Expanded Approach Mode

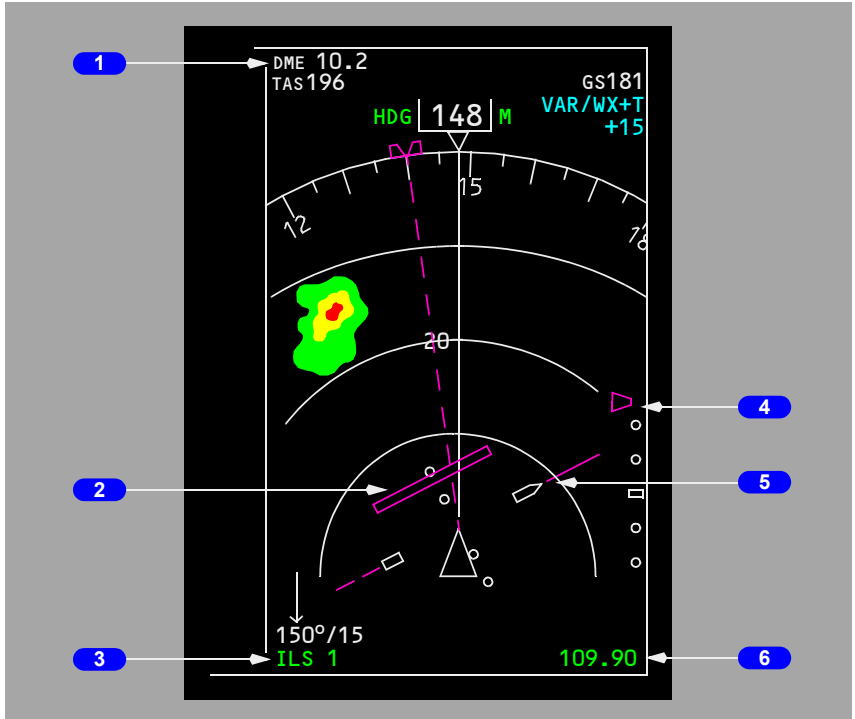

- 1** Reference ILS DME
- 2** Localizer Deviation Indication and Scale
- 3** Reference ILS Receiver
- 4** Glide Slope Pointer and Scale
- 5** Selected Course Pointer
- 6** Reference ILS Frequency

Center Approach Mode

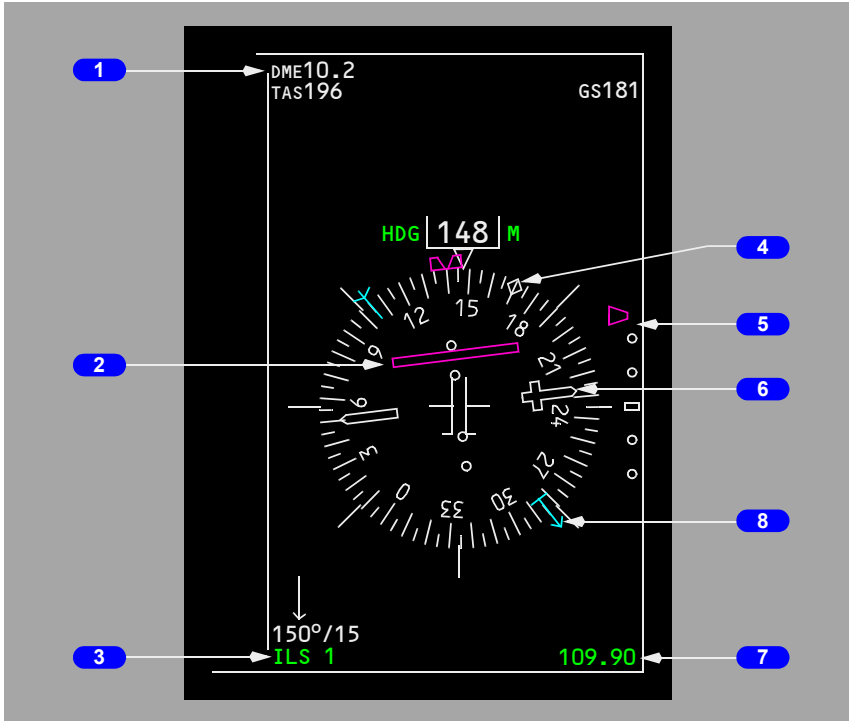

- 1 Reference ILS DME
- 2 Localizer Deviation Indication and Scale
- 3 Reference ILS Receiver
- 4 Drift Angle Pointer
- 5 Glide Slope Pointer and Scale
- 6 Selected Course Pointer
- 7 Reference ILS Frequency
- 8 ADF1 Bearing Pointer

Navigation Displays – VOR Mode

Expanded VOR Mode

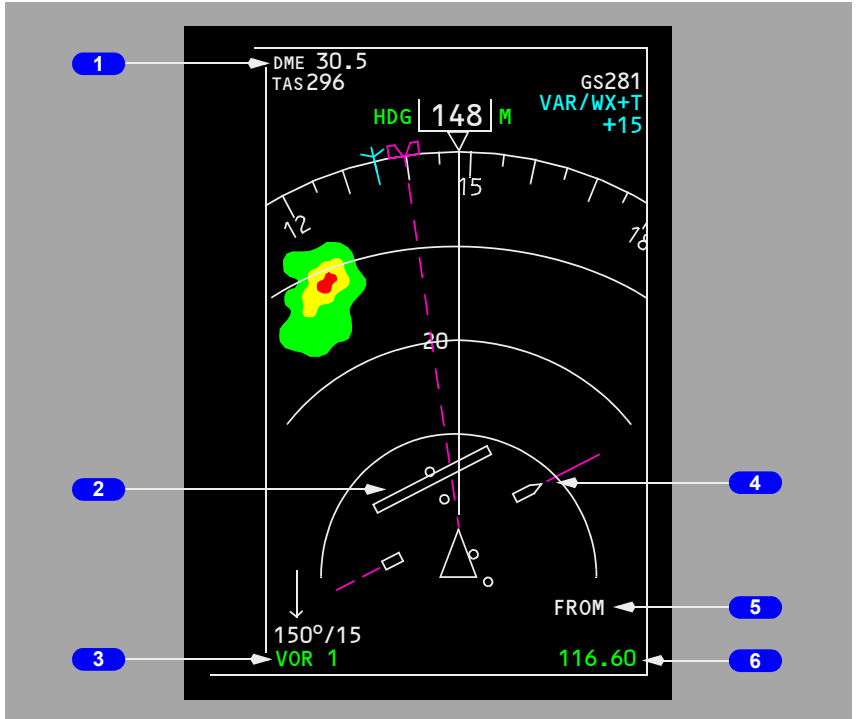

- 1** Reference VOR DME
- 2** Lateral Deviation Indication and Scale
- 3** Reference VOR Receiver
- 4** Selected Course Pointer
- 5** TO/FROM Indication
- 6** Reference VOR Frequency

Center VOR Mode

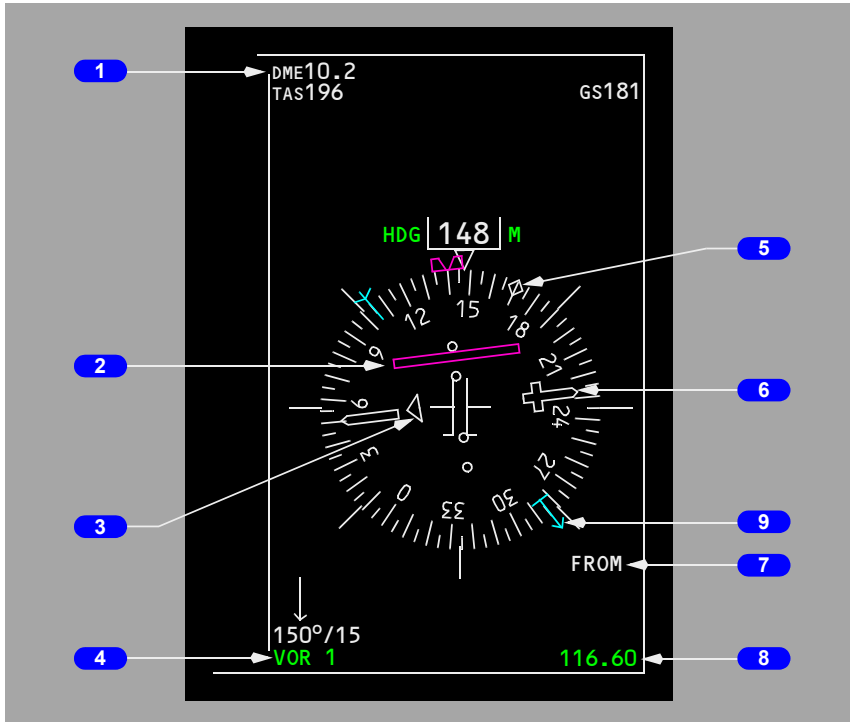

- 1** Reference VOR DME
- 2** Lateral Deviation Indication and Scale
- 3** TO/FROM Pointer
- 4** Reference VOR Receiver
- 5** Drift Angle Pointer
- 6** Selected Course Pointer
- 7** TO/FROM Indication
- 8** Reference VOR Frequency
- 9** ADF1 Bearing Pointer

Navigation Displays – Plan Mode

Plan Mode

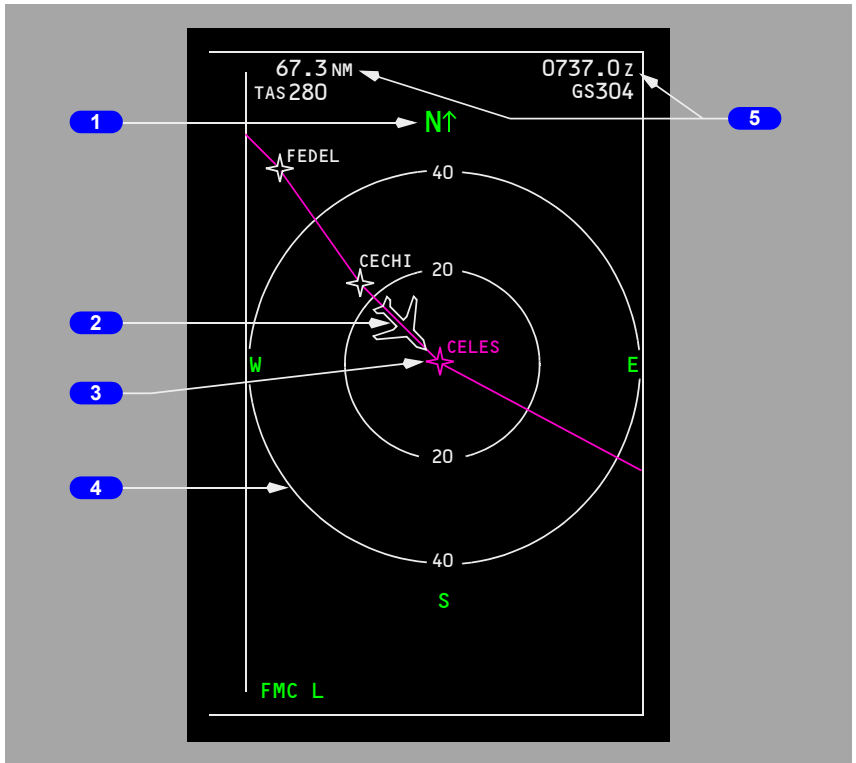

1 True North Up Arrow

2 Airplane Symbol

Denotes current position and true heading. Symbol does not display north of 82N latitude or south of 82S latitude.

3 Center Waypoint

The waypoint located at the display center is identified as CTR on the CDU RTE LEGS page.

4 Range Circle

5 Active Waypoint Information

Navigation Displays – Advisory Messages

Mode/Frequency Disagree Annunciation

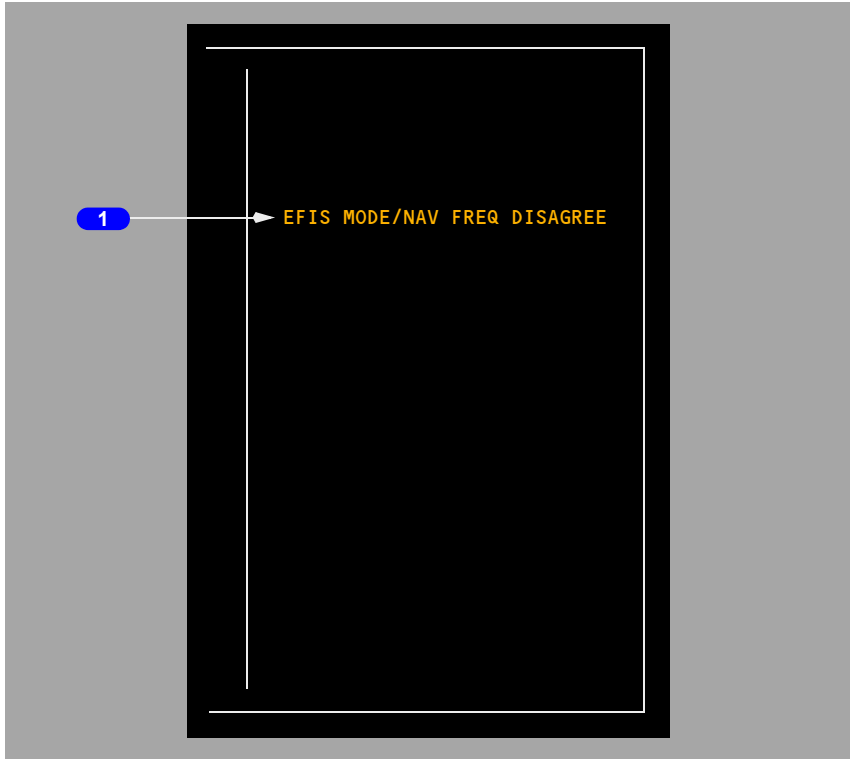

1 Mode/Frequency Disagree Annunciation (amber)

Indicates APP is selected with a VOR frequency tuned, or VOR is selected with an ILS frequency tuned.

- the annunciation only applies to an on–side comparison of the EFIS control panel mode and tuned VOR/ILS frequency
- applicable to expanded and center APP and VOR modes
- dashes displayed on DME display and ILS/VOR frequency display
- localizer deviation bar, VOR course deviation bar, and glide slope pointer (for APP mode) are not displayed.

Navigation Advisory Messages

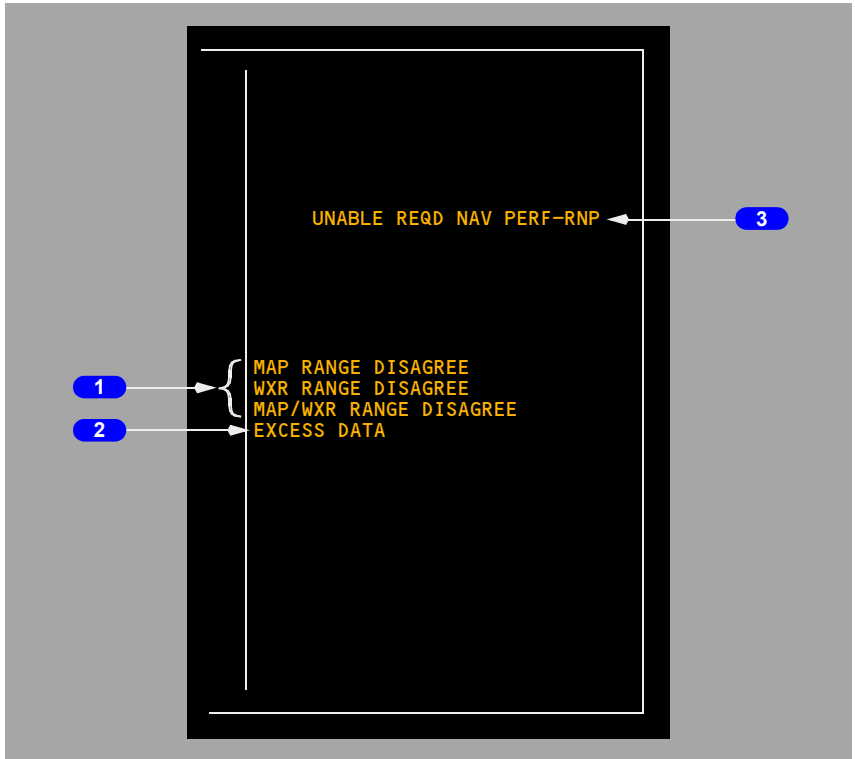

1 Range Disagreement Annunciations (amber)

MAP RANGE DISAGREE – Indicates selected range on the EFIS control panel is different than the MAP display range.

WXR RANGE DISAGREE – Indicates selected range on the EFIS control panel is different than the WXR display range.

MAP/WXR RANGE DISAGREE – Indicates selected range on the EFIS control panel is different than the MAP and WXR display ranges.

2 EXCESS DATA Annunciation (amber)

The amount of data sent to the navigation display exceeds the display capability.

3 Nav Advisory Message (amber)

UNABLE REQD NAV PERF-RNP – Displayed in MAP or Center MAP during approach. Refer to Chapter 11 section 60, FMC Messages.

TCAS Messages

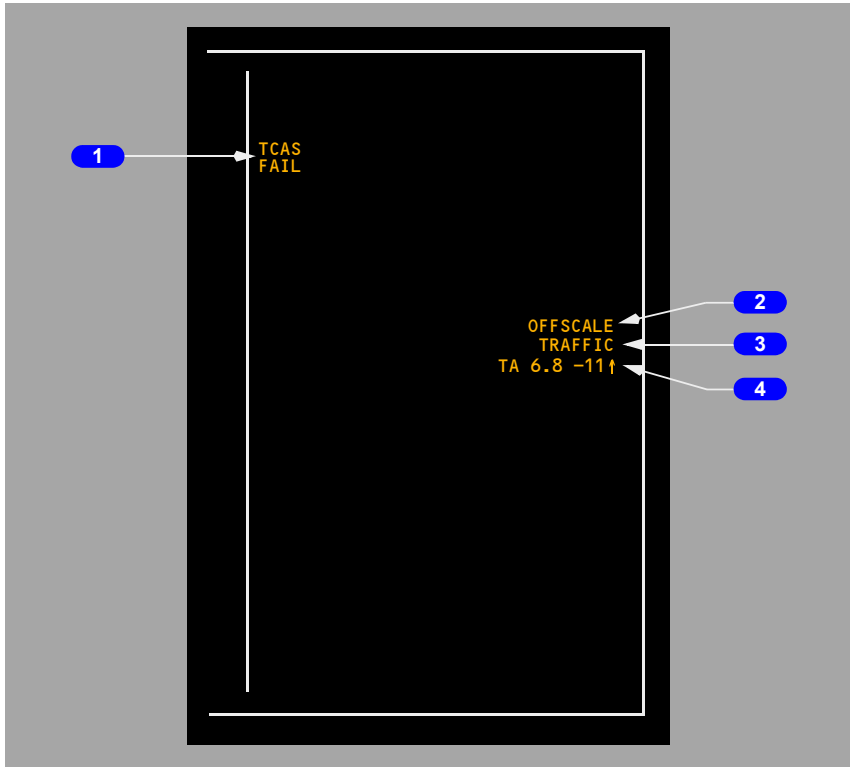

1 TCAS Annunciations

TFC (cyan) – TFC selected on the EFIS control panel in Expanded MAP, Center MAP, Expanded APP or Expanded VOR modes.

TCAS TEST (cyan) – TCAS in test mode.

TCAS FAIL (amber) – TCAS has failed.

TA ONLY (cyan) – TCAS TA only mode.

TCAS OFF (amber) – TCAS off.

2 OFFSCALE (red or amber)

TA (amber) or RA (red) is beyond the display range.

3 TRAFFIC (red or amber)

Displayed during a TA (amber) or RA (red) condition.

4 No Bearing Message (red or amber)

Displayed when no bearing information is available for traffic.

Look-Ahead Terrain Messages (GPWS)

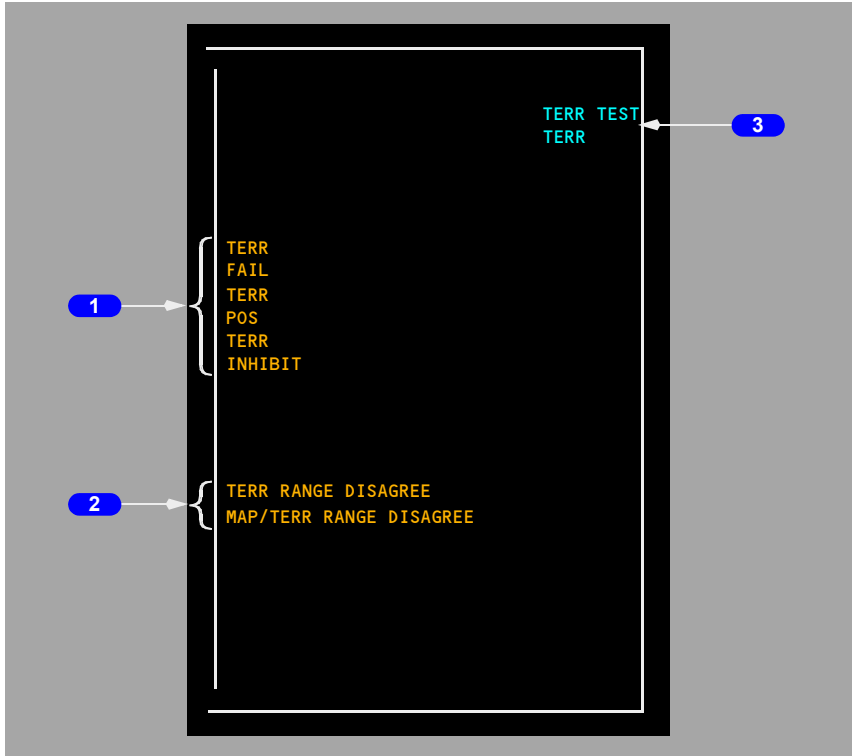

1 Terrain Status Annunciation (amber)

TERR FAIL – Look-ahead terrain alerting and display have failed.

TERR POS – Look-ahead terrain alerting and display unavailable due to position uncertainty.

TERR INHIBIT – GPWS terrain inhibit switch in TERR INHIBIT position.

2 Terrain Range Status Annunciation (amber)

TERR RANGE DISAGREE –

- terrain display enabled, and
- terrain output range disagrees with selected EFIS control panel range.

MAP/TERR RANGE DISAGREE –

- terrain display enabled, and
- terrain output range disagrees with selected EFIS control panel range, and
- map display output range disagrees with selected EFIS control panel range.

3 Terrain Mode Annunciation (cyan)

TERR TEST – GPWS is operating in self-test mode.

TERR – Terrain display enabled (manual or automatic display).

Predictive Windshear System (PWS) Message

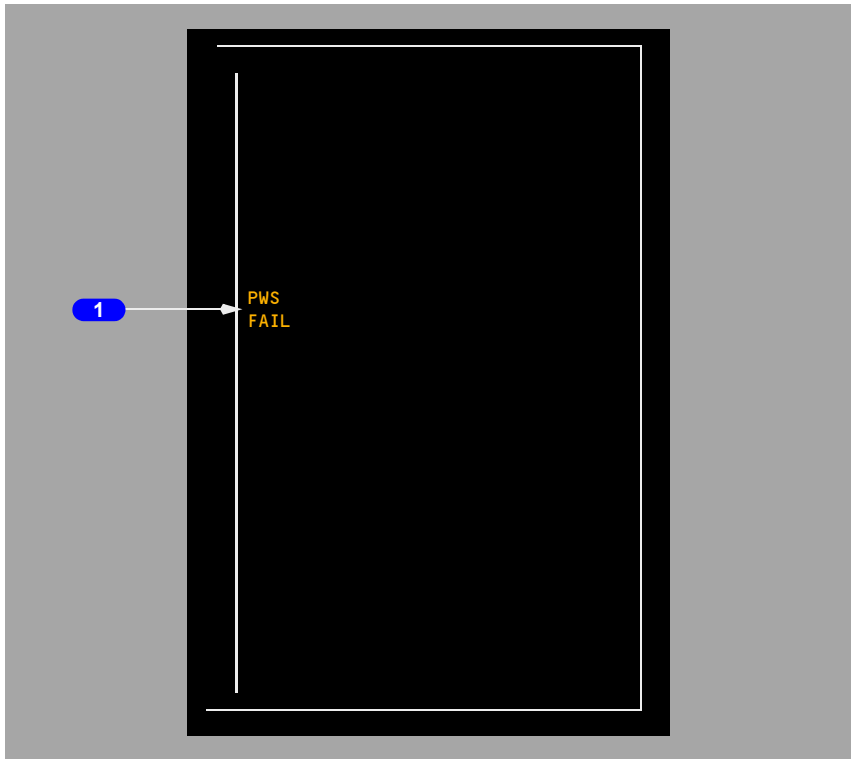

1 PWS FAIL Annunciation (amber)

Predictive windshear alerting and display have failed.

Navigation Displays – Failure Indications and Flags

Dashes replace numbers if there is no computed information. Failure flags replace symbols or failure messages are displayed, as appropriate.

Failure Flags – Expanded MAP, Center MAP, Expanded APP, Expanded VOR Modes

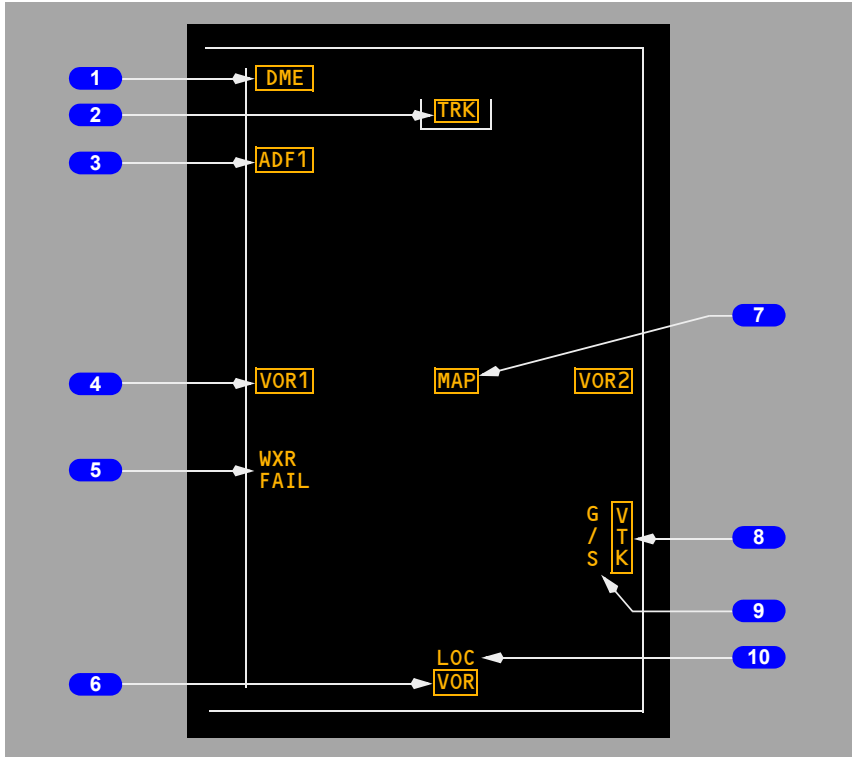

1 DME Failure Flag (APP and VOR modes)

DME display has failed.

2 Track Failure Flag (MAP modes)

Track data have failed.

3 ADF Failure Flag (MAP, APP and VOR modes)

ADF display has failed.

4 VOR Failure Flag (MAP modes)

EFIS control panel POS switch selected and VOR display failed.

5 Weather Radar Annunciations (MAP, APP and VOR modes)

WXR FAIL – Weather radar has failed. No weather data are displayed.

WXR WEAK – Weather radar calibration fault.

WXR ATT – Attitude stabilization for antenna has been lost.

WXR STAB – Antenna stabilization is off.

WXR DSP – Display unit cooling has been lost or an overheat condition has occurred. Weather radar display is blanked.

6 VOR Failure Flag (VOR modes)

VOR display has failed.

7 MAP Failure Flag (MAP modes)

The related FMC generated map display has failed.

8 Vertical Track Failure Flag (MAP modes)

FMC vertical track data are invalid.

9 ILS Glide Slope Failure Flag (APP modes)

ILS glide slope display has failed.

10 ILS Localizer Failure Flag (APP modes)

ILS localizer display has failed.

Failure Flags – Center APP and Center VOR Modes

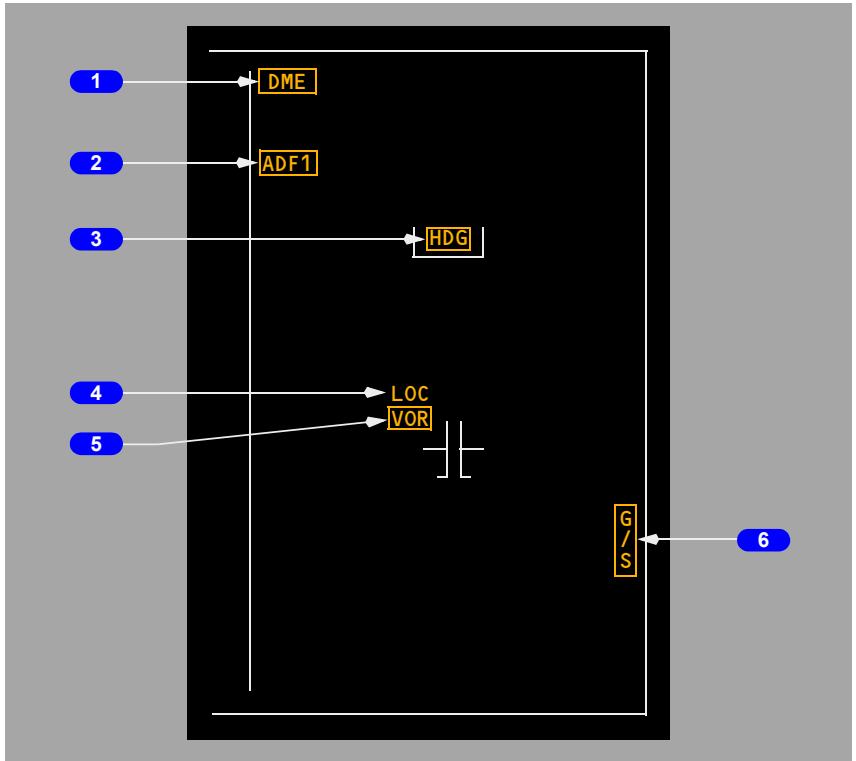

1 DME Failure Flag (APP and VOR modes)

DME display has failed.

2 ADF Failure Flag (APP and VOR modes)

ADF display has failed.

3 Heading Failure Flag (APP and VOR modes)

Heading display has failed.

4 ILS Localizer Failure Flag (APP modes)

ILS localizer display has failed.

5 VOR Failure Flag (VOR modes)

VOR display has failed.

6 ILS Glide Slope Failure Flag (APP modes)

ILS glide slope display has failed.

Additional Flags and Annunciations

Displays Control Panel Annunciation

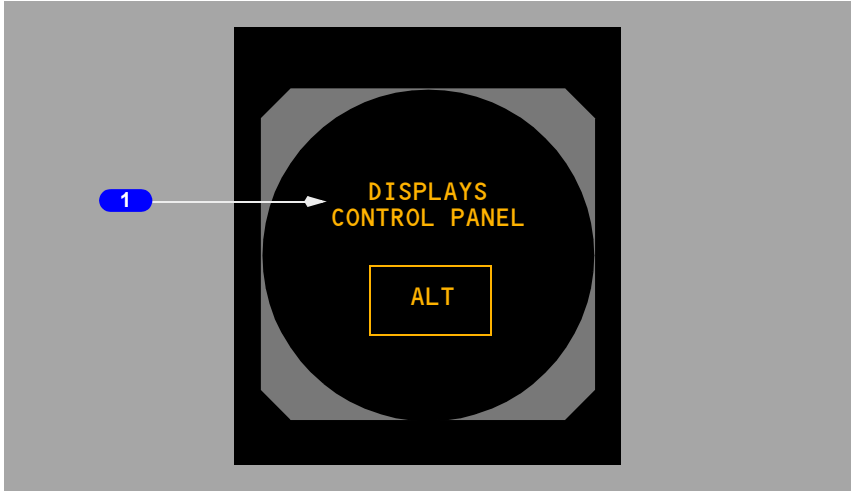

1 Displays Control Panel Annunciation (amber)

With the CONTROL PANEL select switch on the overhead panel in:

- BOTH ON 1 - left (Capt) EFIS control panel has failed
- NORMAL - corresponding EFIS control panel has failed
- BOTH ON 2 - right (F/O) EFIS control panel has failed.

Altitude information is removed.

Display System Annunciations

Note: The following annunciations occupy the same display location above the altimeter.

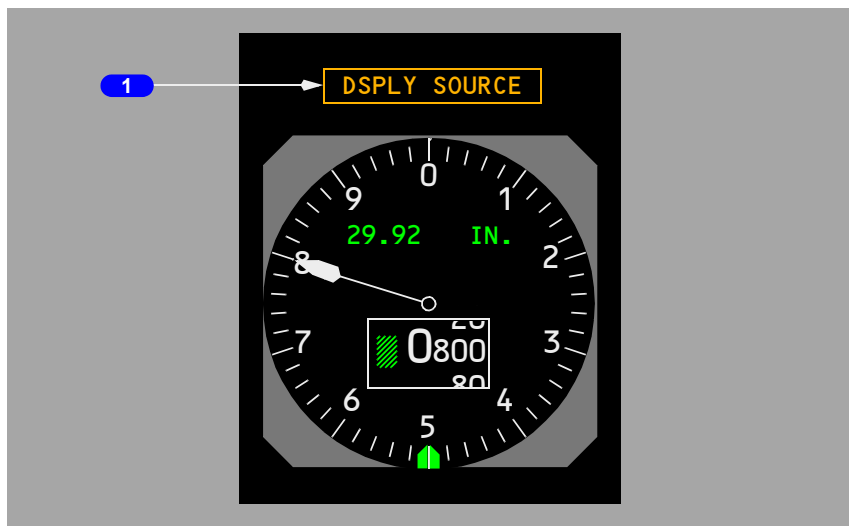

1 Display System Annunciations

DSPLY SOURCE (amber) – A single DEU has been selected, either manually or automatically, to drive all six display units.

- If the DEU fails on the same side as the engaged autopilot during climb or descent –
 - the flight director pitch command bars are removed from both pilots' displays. The pitch command bars reappear at ALT ACQ
 - the pitch mode reverts to CWS pitch
 - the autopilot remains engaged.
- If the DEU fails on the same side as the engaged autopilot during level flight –
 - climb or descent to a new MCP altitude is not possible in LVL CHG, VNAV, or V/S modes with the autopilot engaged.
- If the DEU fails on the opposite side as the engaged autopilot or while in manual F/D mode during climb or descent –
 - the flight director pitch command bar is removed from the pilot's display on the failed side until ALT ACQ
 - climb or descent is possible in LVL CHG, VNAV or V/S modes with the autopilot engaged.

- If the DEU fails on the same side as the engaged autopilot in the APPROACH mode –
 - the flight director pitch and roll command bars are removed from the pilot's display on the failed side.

CDS MAINT (white) – A dispatchable CDS fault has occurred. Displayed on the ground only, prior to start of the second engine.

CDS FAULT (amber) – A non-dispatchable CDS fault has occurred. Displayed on the ground only, prior to start of the second engine.

Instrument Switch Annunciation



1 INSTR SWITCH Annunciation (amber)

Indicates both the Captain's and First Officer's displays are using the same source of IRU data. Displayed when the IRS switch on the overhead panel is not in the NORMAL position.

This Section Applies to YA373 - YA377, YC202 - YE326

PFD/ND Display System – Overview

Display Units

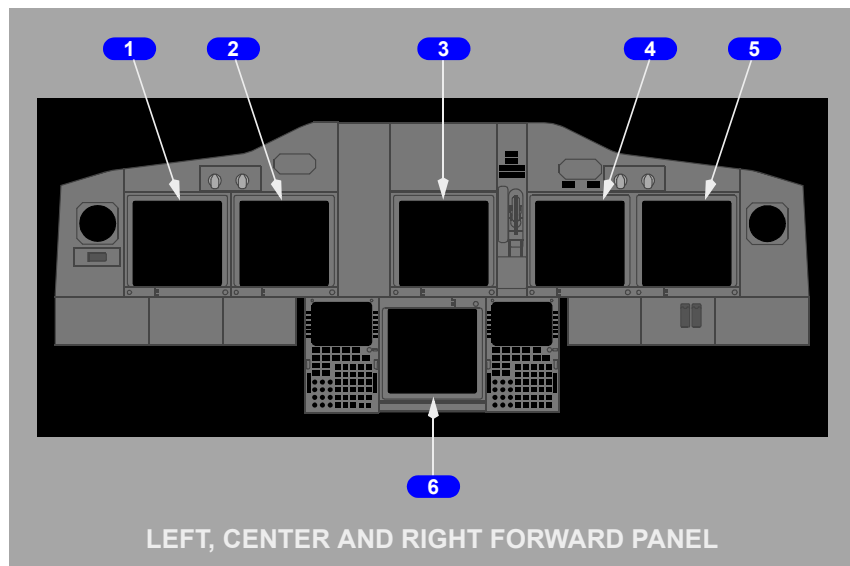

- 1** Captain Outboard Display Unit
- 2** Captain Inboard Display Unit
- 3** Upper Display Unit
- 4** First Officer Inboard Display Unit
- 5** First Officer Outboard Display Unit
- 6** Lower Display Unit

Captain Outboard Display

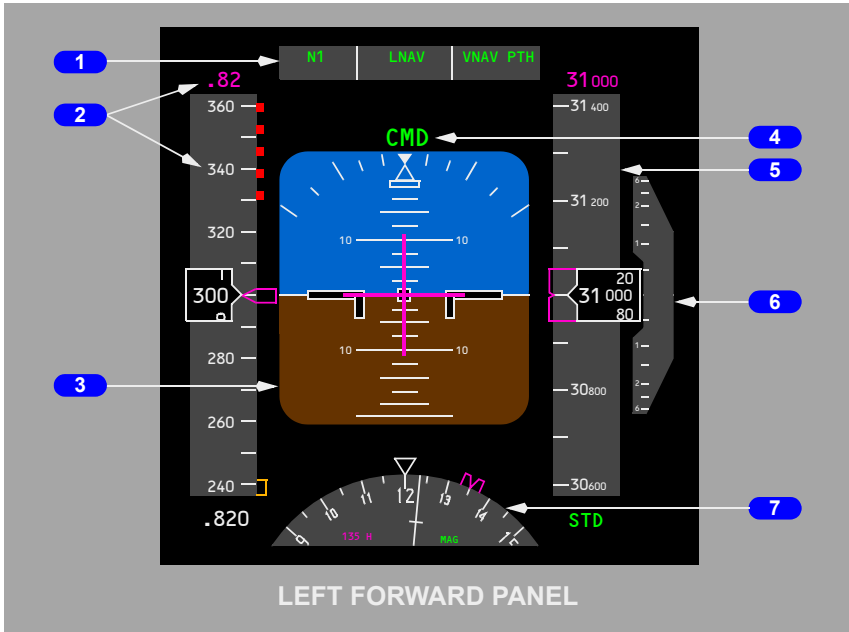

1 Flight Mode Annunciator

Refer to Chapter 4, Automatic Flight

2 Airspeed/Mach Indications

3 Attitude Indications

4 Autopilot, Flight Director System Status

5 Altitude Indications

6 Vertical Speed Indications

7 Heading/Track Indications

Captain Inboard Display



1 Navigation Display

Displays map, approach, VOR, or plan modes as selected on the EFIS control panel.

First Officer Inboard Display



1 Navigation Display

Displays map, approach, VOR, or plan modes as selected on the EFIS control panel.

First Officer Outboard Display

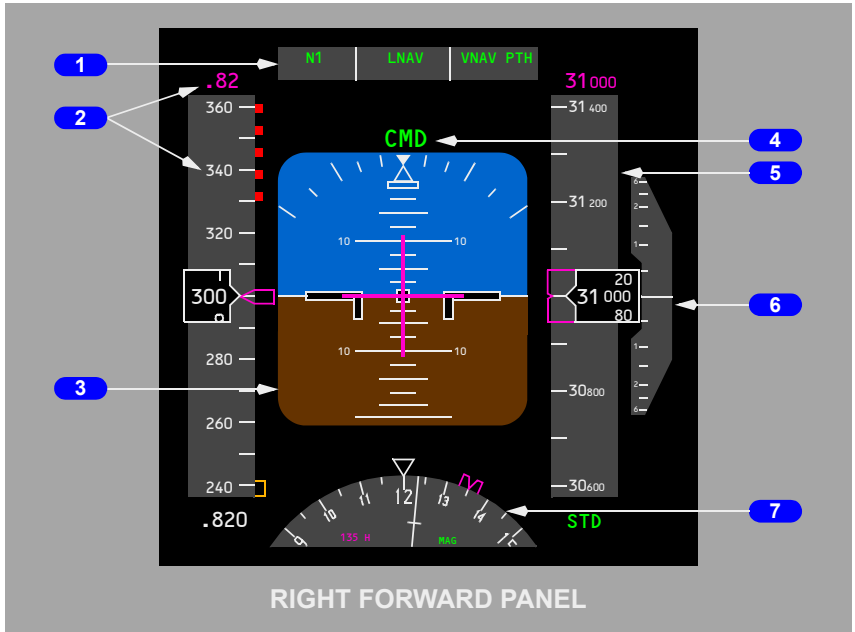

1 Flight Mode Annunciator

Refer to Chapter 4, Automatic Flight

2 Airspeed/Mach Indications

3 Attitude Indications

4 Autopilot, Flight Director System Status

5 Altitude Indications

6 Vertical Speed Indications

7 Heading/Track Indications

Primary Flight Display (PFD)– PFD Airspeed Indications

PFD Airspeed Indications – General

The PFD airspeed indication displays air data inertial reference system (ADIRS) airspeed and other airspeed related information.

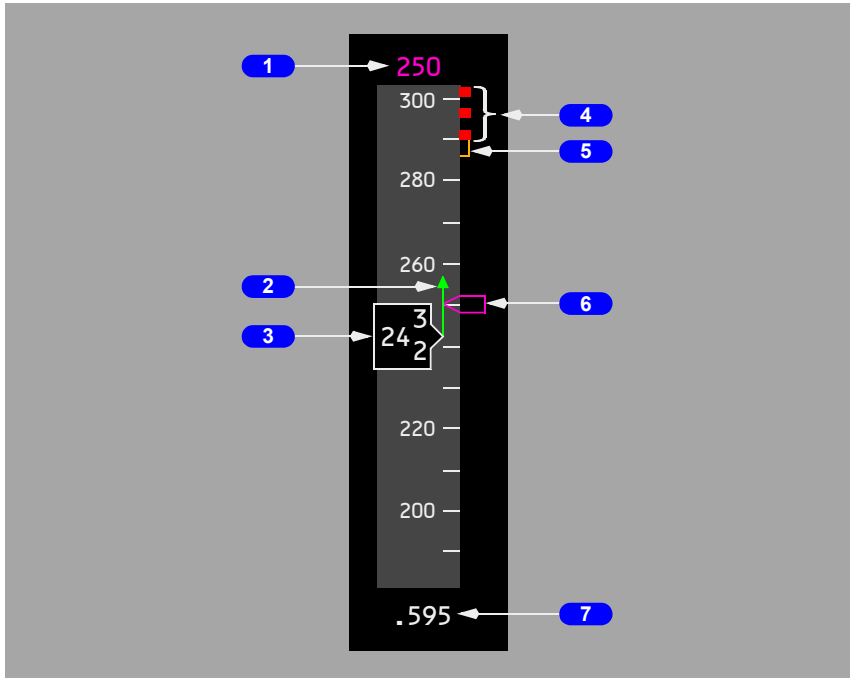

1 Selected Speed (magenta)

Displays target airspeed:

- indicates the airspeed manually selected in the IAS/MACH window
- indicates the FMC computed airspeed when the IAS/MACH window is blank.

2 Speed Trend Vector (green)

Tip of arrow indicates predicted airspeed in the next 10 seconds based on the current airspeed and acceleration.

3 Current Airspeed (white)

Indicates current calibrated airspeed in knots.

737 Flight Crew Operations Manual

When current airspeed decreases into the minimum maneuver speed amber bar:

- airspeed readout box turns amber and flashes for 10 seconds
- box returns to white when airspeed is above minimum maneuver speed.

4 Maximum Speed (red and black)

Bottom of the bar indicates the maximum speed as limited by the lowest of the following:

- V_{mo}/M_{mo}
- landing gear placard speed
- flap placard speed.

5 Maximum Maneuvering Speed (amber)

Bottom of the bar indicates the airspeed that provides a 0.3 g maneuver margin to high speed buffet. May be displayed at high altitude with flaps up, at relatively high gross weights.

6 Speed Bug (magenta)

Points to the airspeed:

- manually selected in the IAS/MACH window
- indicates the FMC computed airspeed when the IAS/MACH window is blank.

When the selected speed is off scale, the bug is parked at the top or bottom of the tape, with only one half bug visible.

7 Current Mach/Groundspeed (white)

Indicates current Mach or groundspeed:

- displays Mach when airspeed is 0.40 Mach and above
- displays groundspeed when airspeed decreases below 0.40 Mach
- when transitioning from Mach to groundspeed or from groundspeed to Mach, a white box shows around the numeric value for 10 seconds.

PFD Airspeed Indications – Takeoff and Approach

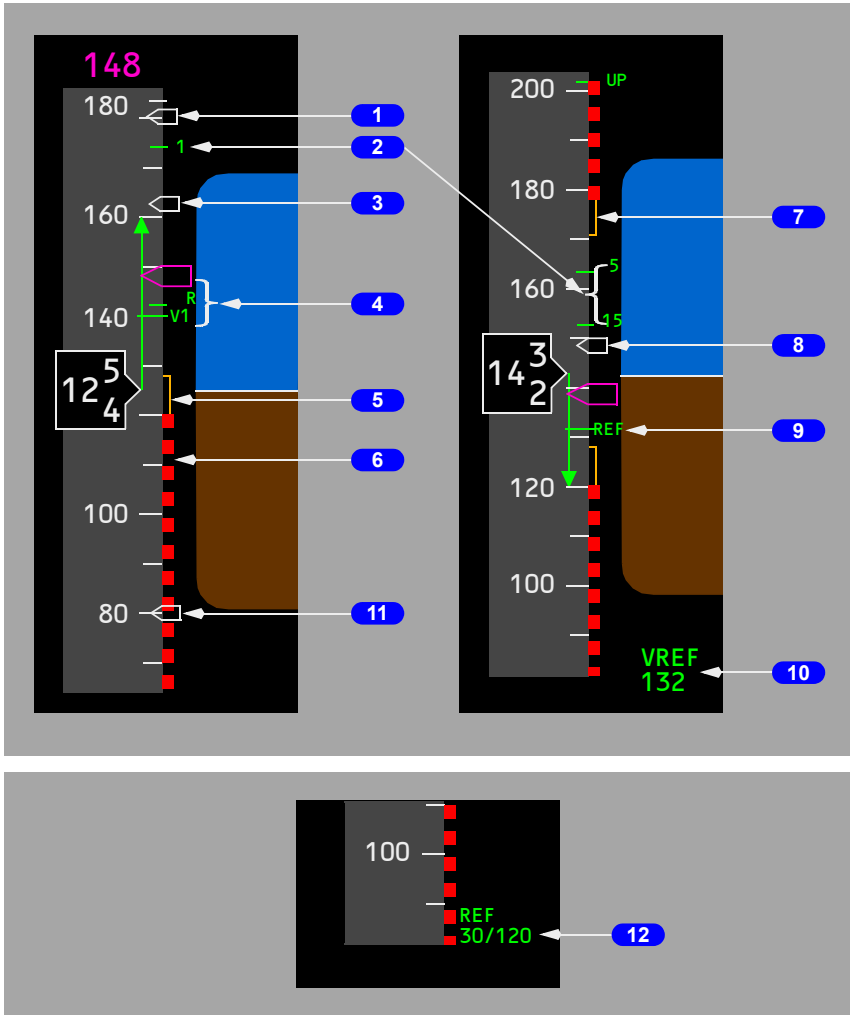

1 Bug 5 (white)

Displayed if speed reference selector on the engine display control panel is in the bug 5 position or SET position and a value greater than 60 knots has been selected. Not available if the speed reference selector is in the AUTO position.

2 Flaps Maneuvering Speeds (green)

Indicates flap maneuvering speed for the displayed flap position:

- displayed after gross weight is entered in the CDU or after takeoff gross weight is set with the speed reference selector
- when the V2+15 bug is displayed for takeoff, the flap maneuvering speed bug for the current flap setting is not displayed, except for flaps 1 takeoff.
- numbered flap maneuvering speed bugs are removed when flap lever is moved to flaps 30 or 40
- flap bugs inhibited if less than VREF +4
- UP bug not displayed above approximately 20,000 feet altitude.

3 V2+15 (white)

Displayed for takeoff.

Removed when either of the following occurs:

- at first flap retraction
- when VREF is entered in the CDU.

4 Takeoff Reference Speeds (green)

Indicates V1 (decision speed) and VR (rotation speed) as selected on the CDU TAKEOFF REF page (refer to Chapter 11, Flight Management, Navigation) or as set with the speed reference selector on the engine display control panel:

- amber NO VSPD is displayed on the ground if V1 or VR is not selected on the CDU or is not set with the speed reference selector
- displayed for takeoff when speed is greater than 80 knots
- removed at lift-off
- V1 speed is displayed at the top of airspeed indication when selected and value is off scale.

5 Minimum Maneuver Speed (amber)

Top of bar indicates minimum maneuver speed.

Inhibited on takeoff until first flap retraction or valid VREF entered.

6 Minimum Speed (red and black)

Top of bar indicates the speed at which stick shaker occurs.

7 Maximum Maneuvering Speed (amber)

When flaps are not up, bottom of the bar indicates flap limit placard speed for the next normal flap setting. The display logic is based on a normal flap setting sequence of 1, 5, 15, 30. The bar is removed when the flaps reach the landing flap selected on the APPROACH REF page or when the flaps reach flaps 40.

8 VREF+15 (white)

YA373 - YA377, YC202 - YC206, YE321 - YE326

Displayed after selection of VREF.

8 VREF+20 (white)

YC207

Displayed after selection of VREF.

9 Landing Reference Speed (green)

Indicates REF (reference speed) as selected on the CDU APPROACH REF page (refer to Chapter 11, Flight Management, Navigation) or as set with the speed reference selector on the engine display control panel.

REF speed is displayed at the bottom of airspeed indication when selected and value is off scale.

10 Speed Reference Display (green)

Displayed if the airspeed and/or weight is entered via the speed reference selector on the engine display control panel:

- on the ground, V1, VR, and takeoff gross weight may be selected; if VREF is selected, INVALID ENTRY is displayed
- in flight, VREF and landing gross weight may be selected; if V1 or VR is selected, INVALID ENTRY is displayed
- removed when the speed reference selector is moved to the SET position.

11 80 Knot Airspeed Bug (white)

Indicates 80 knots:

- displayed automatically during preflight
- removed at first flap retraction or when VREF is entered.

12 Flap/VREF Speed Annunciation (green)

Indicates selected landing flap position and VREF as selected on the CDU APPROACH REF page:

- displayed for flaps 15, 30 and 40
- not shown for VREF set with the speed reference selector..

PFD – Attitude Indications

Attitude Indications – General

The attitude indication displays ADIRS attitude information.

YA373 - YA377, YC202 - YC207, YE324 - YE326

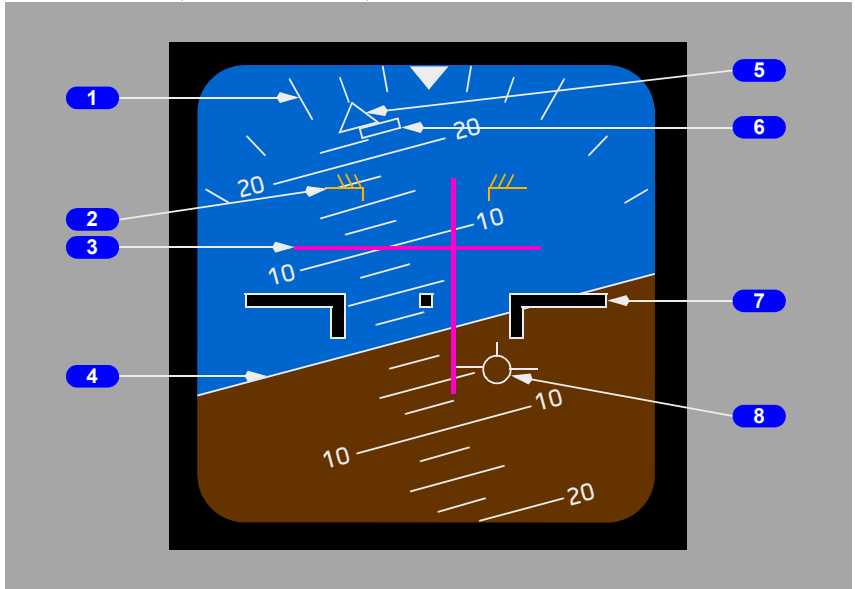

YE321 - YE323

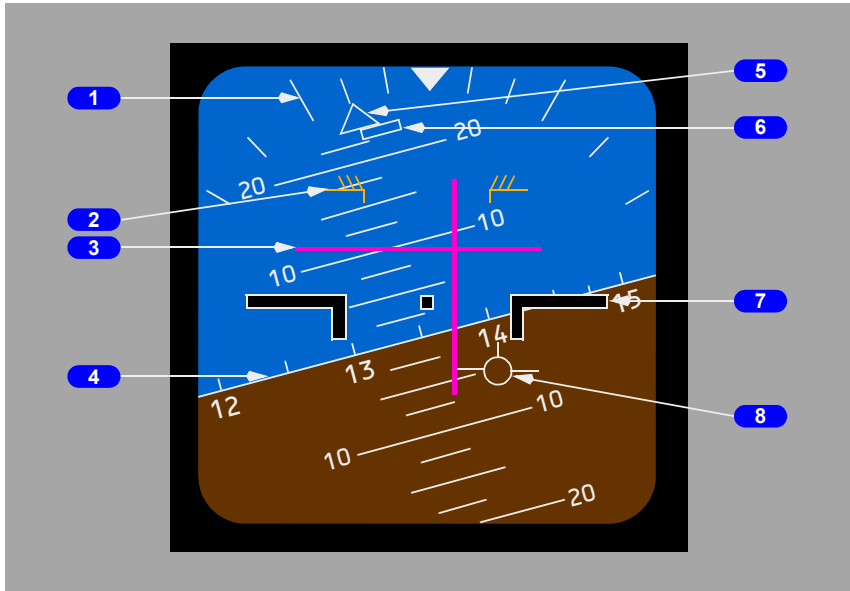

1 Bank Scale (white)

Provides fixed reference for the bank pointer; scale marks are at 0, 10, 20, 30, 45, and 60 degrees.

2 Pitch Limit Indication (amber)

Indicates pitch limit (stick shaker activation for existing flight conditions).

- displayed when the flaps are not up.
- displayed at slow speeds with the flaps up.

3 Flight Director Bar (magenta)

Indicates flight director steering commands. (Refer to Chapter 4, Automatic Flight.)

4 Horizon Line and Pitch Scale (white)

Indicates the horizon relative to the airplane symbol; pitch scale is in 2.5 degree increments.

YE321 - YE323

Horizon scale is in 5 degree increments.

5 Bank Pointer

Indicates bank angle; fills and turns amber if bank angle is 35 degrees or more.

6 Slip/Skid Indication

Displaces beneath the bank pointer to indicate slip or skid:

- fills white at full scale deflection
- turns amber if bank angle is 35 degrees or more; fills amber if the slip/skid indication is also at full scale deflection.

7 Airplane Symbol

Indicates airplane attitude relative to the horizon.

8 Flight Path Vector (FPV) Indication (white)

Displays flight path angle and drift when selected on the EFIS control panel:

- flight path angle is displayed relative to the horizon line
- drift angle is displayed relative to display center.

PFD Navigation Performance Scales (NPS) Indications YE321 - YE323

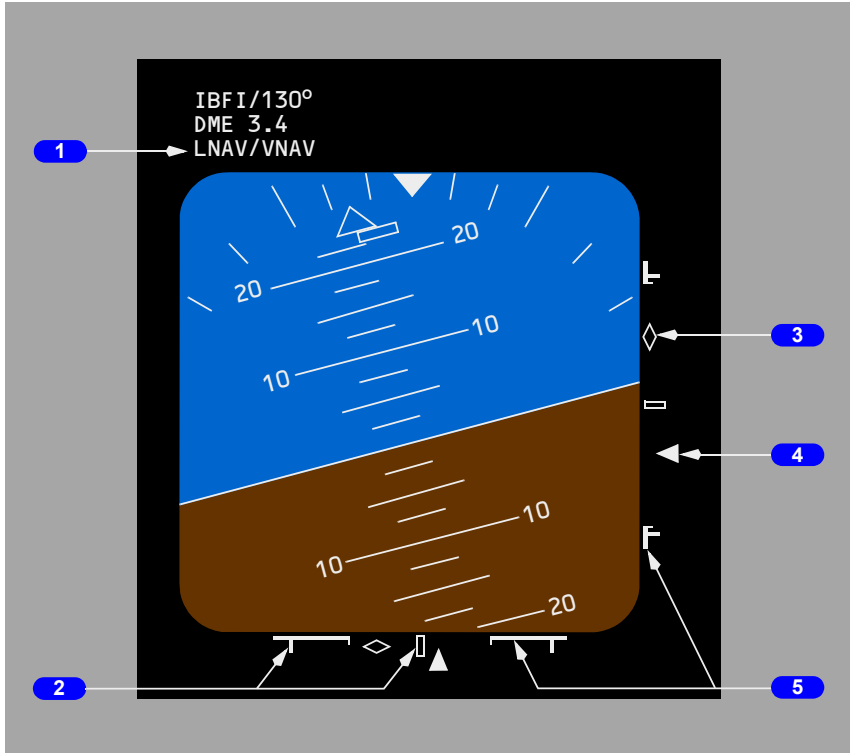

1 Scale ID Annunciation (white)

- displayed when LNAV or VNAV are engaged.
- displayed above the left corner of ADI.
- indicates the source of displayed deviation for each scale.
- Possible annunciations include:
 - LNAV/VNAV - (LNAV and VNAV deviations)
 - LOC/VNAV - (Localizer with VNAV deviation)
 - LNAV/G/S - (LNAV deviation with glideslope)
 - ILS - (ILS approach)

2 NPS Deviation Scale

- lateral NPS deviation scale represents current FMC lateral RNP.
- vertical NPS deviation scale represents current FMC vertical RNP.
- displayed if an approach mode is not engaged and either LNAV or any VNAV mode is engaged.

3 Anticipation Cues

- displayed if valid approach course deviation information is being received while corresponding NPS deviation scale and pointer are displayed.
- an unfilled white diamond symbol.
- if engaged lateral mode subsequently transitions to LOC, lateral NPS deviation indications will be removed, and normal ILS localizer indications will be displayed.
- if engaged vertical mode subsequently transitions to G/S, vertical NPS deviation indications will be removed, and normal ILS G/S indications will be displayed.

4 NPS Pointer

- a filled magenta symbol when it is not parked at deflection limit.
- an unfilled pointer outline when at deflection limit.
- indicates lateral/vertical paths relative to the airplane.
- will flash for 10 seconds if deviation is within ANP bar limits for 10 continuous seconds.

5 Actual Navigation Performance (ANP) Bars

- lateral/vertical indication of available flight technical error remaining based on total system error.
- lateral ANP bars can be displayed in all phases of flight.
- vertical ANP bars can be displayed only after reaching top-of-descent.
- originate from outer scale and expand inward as a function of increasing ANP relative to RNP.
- will just touch at center of scale when ANP equals RNP.
- turn from white to amber if current deviation is within the ANP bar limits for 10 continuous seconds.

PFD Instrument Landing System Indications

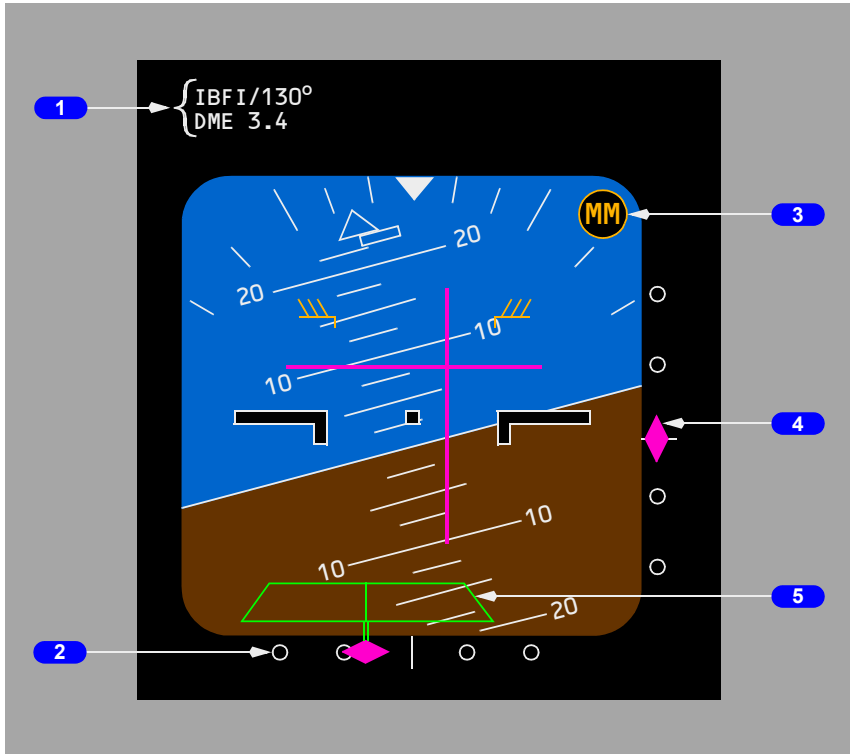

1 Approach Reference

Displays the selected ILS identifier or frequency, approach front course, and ILS/DME distance.

If the tuned ILS frequencies disagree, the frequency turns amber with an amber horizontal line through it.

If the approach courses entered in the MCP disagree, the course turns amber with an amber horizontal line through it.

2 Localizer Pointer and Deviation Scale

The pointer:

- indicates localizer position relative to the airplane
- in view when the localizer signal is received
- fills in solid magenta when within 2 1/2 dots from center.

737 Flight Crew Operations Manual

The scale:

- indicates deviation
- in view when the localizer frequency is tuned
- expands when the localizer is engaged and deviation is slightly more than one-half dot.

At low radio altitudes, with autopilot engaged, the scale turns amber and the pointer flashes to indicate excessive localizer deviation.

Below 1,000 feet AGL, with LNAV engaged and LOC armed, the localizer scale turns amber and the pointer flashes if the localizer is not captured.

Each pilot's deviation alerting system self-tests upon becoming armed at 1500 feet radio altitude. This self-test generates a two second LOC deviation alerting display on each attitude indicator.

3 Marker Beacon symbol

Flashes when over one of the marker beacons:

OM (cyan) - an outer marker beacon

MM (amber) - a middle marker beacon

IM (white) - an inner marker beacon.

4 Glide Slope Pointer and Deviation Scale

The pointer:

- indicates glide slope position.
- in view when the glide slope signal is received.
- fills in solid magenta when within 21/2 dots from center.
- not displayed when the track and the front course on the mode control panel differ by more than 90 degrees (backcourse).

The scale:

- indicates deviation.
- in view when the localizer frequency is tuned.

At low radio altitudes, with autopilot engaged, the scale turns amber and the pointer flashes to indicate excessive glide slope deviation.

Each pilot's deviation alerting system self-tests upon becoming armed at 1500 feet radio altitude. This self-test generates a two second G/S deviation alerting display on each attitude indicator.

5 Rising Runway (green with magenta stem)

Displayed when:

- localizer signal usable and pointer is in view.
- radio altitude is less than 2500 feet.

Rises towards airplane symbol when radio altitude is below 200 feet.

Expanded Localizer Indications

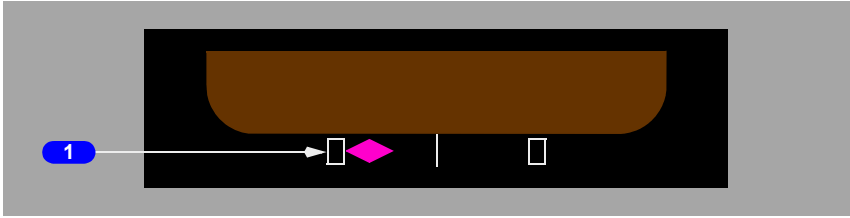

1 Expanded Localizer Scale

Displayed when the autopilot or flight director is in LOC mode, deviation is slightly more than one half dot and track is within 5 degrees of the MCP selected course.

As deviation increases, the deviation pointer remains filled in solid magenta and parks at the limit of the expanded scale. Once the deviation reaches the equivalent of 2.4 dots from center on the standard scale, the pointer becomes unfilled.

Reverts to standard scale when out of LOC mode, and groundspeed is less than 30 knots or radio altitude is greater than 200 feet.

A rectangle equals 1/2 dot deviation.

PFD Radio Altitude Indications

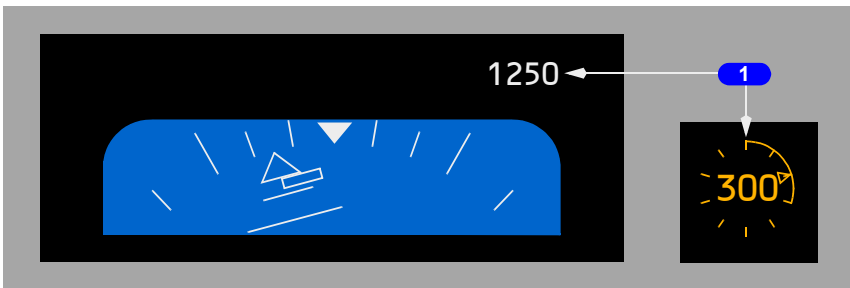

1 Radio Altitude – Round Dial

Displayed below 2500 feet AGL:

- digital display from 2500 to 1000 feet AGL
- box highlighted white for 10 seconds upon descent below 2500 feet
- round dial displays below 1000 feet AGL
- pointer indicates selected radio altitude minimums
- the circumference of the dial is added to, or taken away from, to depict the airplane's radio altitude
- the remaining perimeter and pointer turn amber and flash for 3 seconds when below radio altitude minimums, the numeric readout does not flash.

Traffic Alert and Collision Avoidance Indications

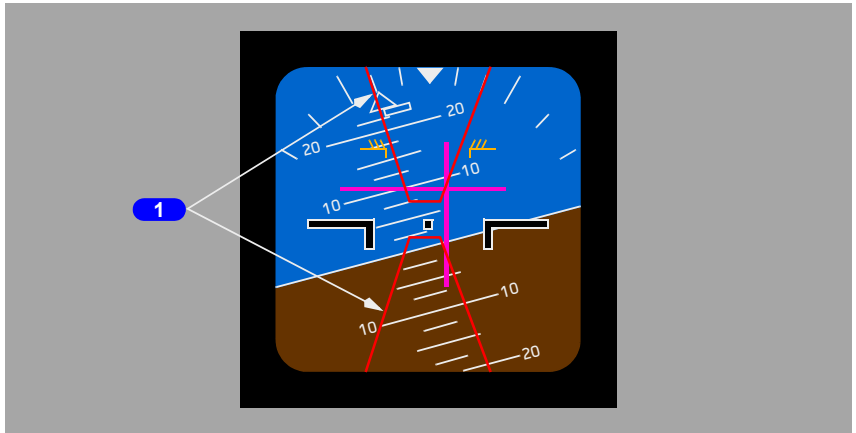

1 Traffic Alert and Collision Avoidance System Pitch Command (red)

The area(s) inside the red lines indicate(s) the pitch region(s) to avoid in order to resolve the traffic conflict. The airplane symbol must be outside the TCAS pitch command area(s) to ensure traffic avoidance. Refer to Chapter 15, Warning Systems.

GPWS Annunciations

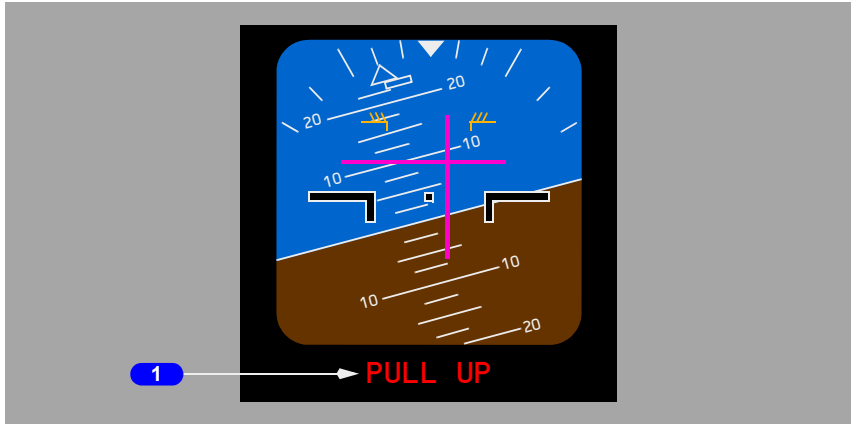

1 GPWS Annunciations (red)

Displays WINDSHEAR or Pull UP alert.

Refer to Chapter 15, Warning Systems.

PFD – Altitude Indications

Altitude Indications– General

The altitude indication displays ADIRS altitude and other altitude related information.

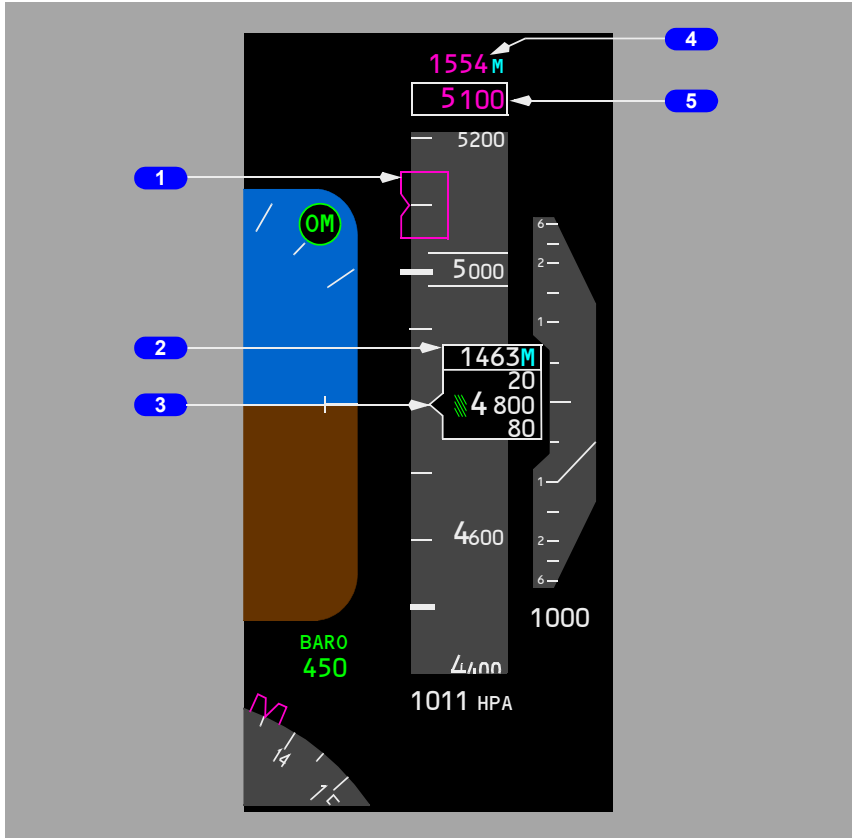

1 Selected Altitude Bug (magenta)

Indicates the altitude set in the MCP altitude window.

When the selected altitude is off scale, the bug is parked at the top or bottom of the tape, with only one half the bug visible.

2 Metric Digital Readout (readout and box–white, metric symbol–cyan)

Displays current altitude in meters when MTRS is selected on the EFIS control panel.

3 Current Altitude

Displays current altitude in increments of thousands, hundreds and twenty feet:

- for positive values of altitude below 10,000 feet, a green crosshatch symbol is displayed
- a negative sign appears when altitude below zero feet is displayed
- readout box becomes bold to denote altitude acquisition
- readout box is highlighted in amber and flashes to denote altitude deviation (refer to Chapter 4, Automatic Flight and Chapter 15, Warning Systems).

4 Metric Selected Altitude Readout (readout—magenta, metric symbol—cyan)

Displays MCP altitude in meters when MTRS is selected on the EFIS control panel.

5 Selected Altitude (magenta)

Displays the altitude set in the MCP altitude window.

The selected altitude box appears in white during an altitude alert. For more information, refer to Chapter 15, Warning Systems.

PFD Barometric Indications

YA373, YA374, YC202 - YC206, YE321 - YE326

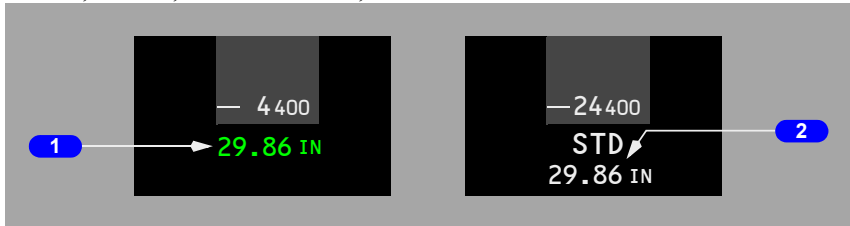

YA375 - YA377, YC207

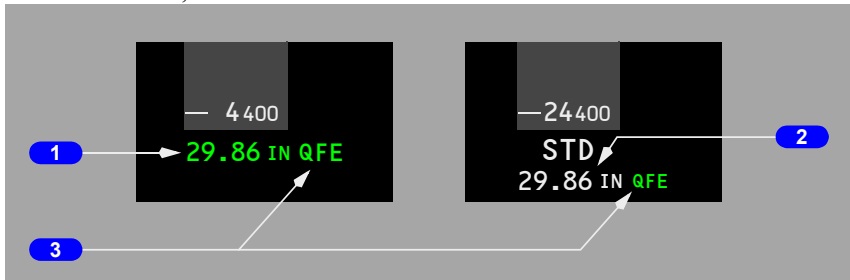

1 Barometric Settings (green)

Indicates the barometric setting in either inches of mercury (IN) or hectopascals (HPA) as selected on the EFIS control panel.

Display is boxed amber if numeric is set and airplane is climbing above transition altitude, or if STD is set and descending below transition flight level.

2 Preselected Barometric Setting (white)

STD is displayed when the Barometric Standard (STD) switch is selected on the EFIS control panel.

When STD is displayed, a barometric setting can be preselected on the EFIS control panel barometric selector and is displayed in small white characters below STD.

3 QFE Altitude Reference (green)

YA375 - YA377, YC207

Indicates QFE altitude reference if selected on the CDU APPROACH REF Page or TAKEOFF REF Page 2/2.

When selected, QFE is boxed for 10 seconds.

The altitude tape is shaded green during QFE operation.

When QNH is selected, the green shading is removed; QNH is displayed for 10 seconds, then blanks.

When STD is displayed, QFE in small white characters is displayed below STD, and a QFE altimeter setting can be preselected.

Landing Altitude/Minimums Indications

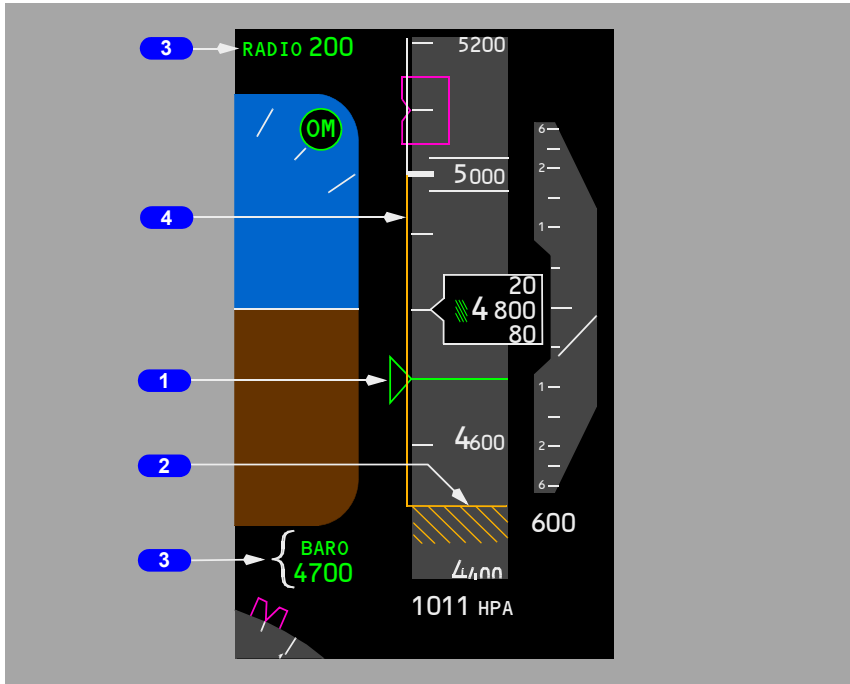

1 BARO Minimums Pointer (green)

Indicates the barometric minimums selected on the EFIS control panel:

- pointer and line turn amber when airplane descends below selected minimum altitude
- reset with the RST switch on the EFIS control panel.

YE321 - YE323

After the pointer is set with the BARO position, moving the Minimums Reference selector to RADIO displays only the pointer.

2 Landing Altitude Indication (amber)

The crosshatched area indicates:

- the FMC landing altitude for the destination runway or airport, or
- the landing altitude for departure runway or airport until 400 NM from departure or one-half the distance to destination, whichever occurs first.

3 Minimums Reference/Altitude (green)

Displays approach minimum reference and altitude set by the MINS selector on the EFIS control panel:

BARO -

- displayed below ADI when selector is set to BARO, minimums are in feet MSL
- turns amber and flashes for 3 seconds when airplane descends below selected minimum altitude.
- changes back to green:
 - when passing the selected minimum altitude plus 75 feet during go-around
 - at touchdown
 - after pressing the RST switch on the EFIS control panel.

RADIO -

- displayed above ADI when selector is set to RADIO, minimums are in feet AGL
- blank when an altitude less than 0 feet is selected
- turns amber and flashes for 3 seconds when airplane descends below selected minimum altitude
- changes back to green:
 - when passing the selected minimum altitude plus 75 feet during go-around
 - at touchdown
 - after pressing the RST switch on the EFIS control panel.

4 Landing Altitude Reference Bar

Indicates height above touchdown:

- White bar - 500 to 1000 feet above landing altitude
- Amber bar - 0 to 500 feet above landing altitude.

PFD – Vertical Speed Indications

Vertical Speed Indications – General

The vertical speed indication displays ADIRS instantaneous vertical speed.

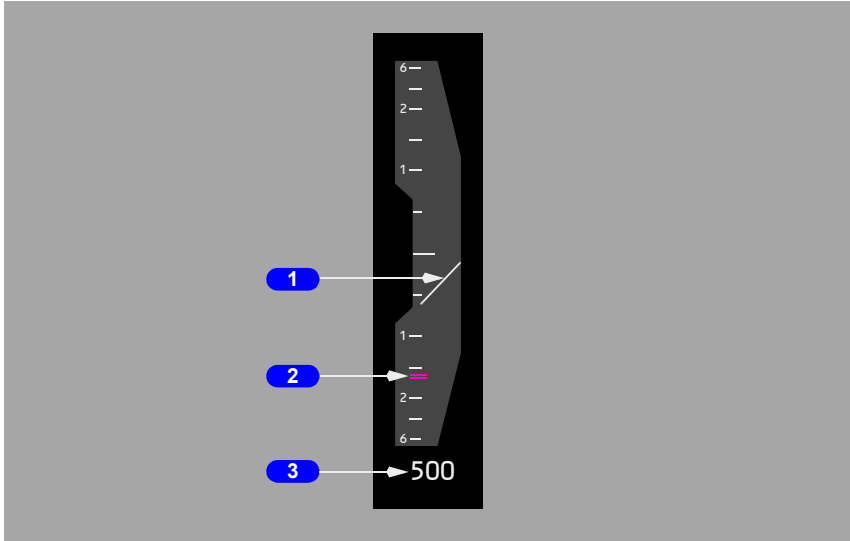

1 Vertical Speed Pointer (white)

Indicates current vertical speed.

2 Selected Vertical speed Bug (magenta)

Indicates the speed selected in the MCP vertical speed window with V/S pitch mode engaged.

3 Vertical speed (white)

Displays vertical speed when greater than 400 feet per minute.

The display is located above the vertical speed indication when climbing and below when descending.

PFD - Heading and Track Indications

Heading and Track Indications– General

The heading and track indications display current FMC/ADIRS heading, track and other information.

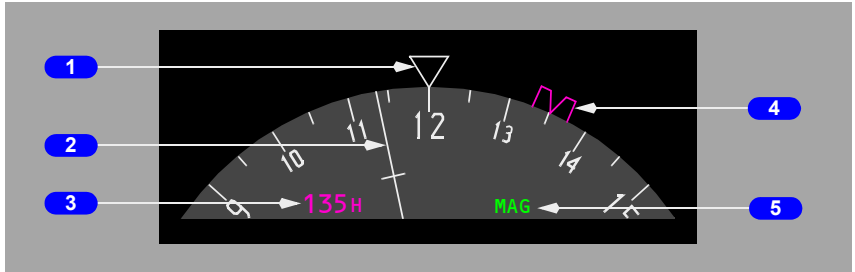

1 Current Heading Pointer (white)

Indicates current heading.

2 Track Pointer (white)

Indicates current track.

3 Selected Heading (magenta)

Digital display of the selected heading bug.

4 Selected Heading Bug (magenta)

Indicates the heading selected on the mode control panel. If the selected heading exceeds the display range, the bug parks on the side of the compass rose in the direction of the shorter turn to the heading.

5 Magnetic/True Heading Annunciation (green)

Displays selected heading reference:

- MAG indicates display is oriented relative to magnetic north
- TRU indicates display is oriented relative to true north; a white box is displayed continuously around TRU
- transition from TRU to MAG results in a green box around MAG for 10 seconds
- when TRU is displayed and the airplane descends more than 2000 feet at a descent rate greater than -800 feet per minute, an amber box is drawn around TRU; the box flashes for 10 seconds, then turns steady amber.

PFD Failure Flags

The flag replaces the appropriate display to indicate source system failure or lack of computed information.

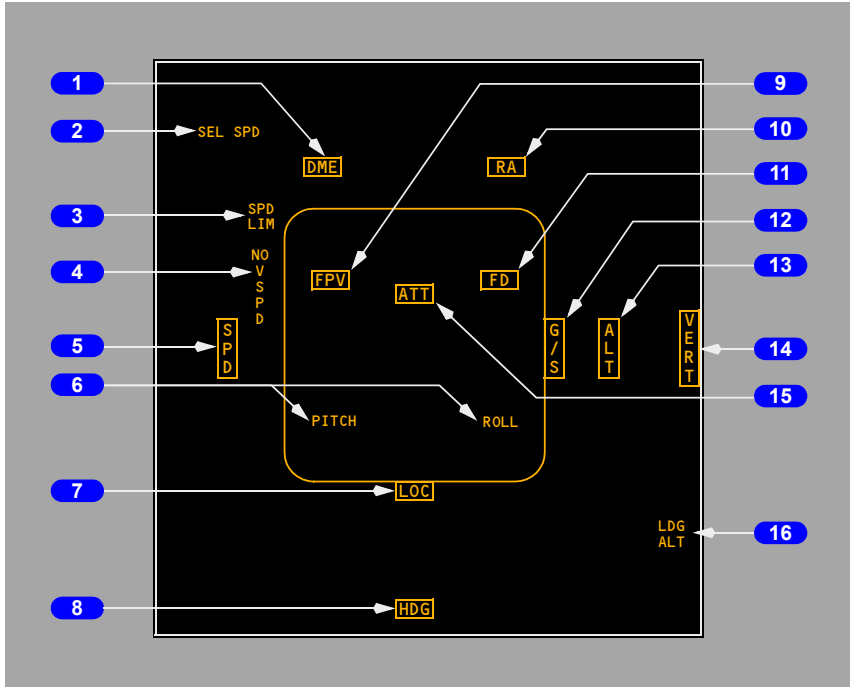

1 Distance Measuring Equipment (amber)

The DME system has failed.

2 Selected Speed (amber)

Invalid data.

3 Speed Limit Flag (amber)

Displays related with stick shaker or maximum operating speed has failed:

- if the stick shaker warning has failed, the red and black stick shaker speed bar is removed
- if the maximum operating speed has failed, the red and black maximum operating speed bar is removed.

4 No V Speeds Flag (amber)

V1 (decision speed) or VR (rotation speed) has not been entered or is invalid.

5 Speed Flag (amber)

The speed indication is inoperative. All indication markings are removed.

6 Pitch/Roll Comparator Annunciation (amber)

PITCH displayed when Captain's and F/O's pitch angle displays differ by more than 5 degrees.

ROLL displayed when Captain's and F/O's roll angle displays differ by more than 5 degrees.

The flags flash for 10 seconds then remain steady.

7 Localizer Flag (amber)

An ILS frequency is tuned and the ILS localizer deviation display on the attitude indication has failed.

8 Heading Flag (amber)

Heading information failed.

9 Flight Path Vector Flag (amber)

FPV is selected on the EFIS control panel, but has failed. De-selection of FPV removes the flag.

10 Radio Altitude Flag (amber)

The radio altitude display has failed.

11 Flight Director Flag (amber)

The flight director has failed.

12 Glide Slope Flag (amber)

An ILS frequency is tuned and the ILS glide slope deviation display on the attitude indication has failed.

13 Altitude Flag (amber)

The attitude display has failed.

14 Vertical Speed Flag (amber)

Vertical speed has failed.

15 Attitude Flag (amber)

The attitude display has failed.

16 Landing Altitude Flag (amber)

The landing altitude input is not available or invalid.

Additional Annunciations and Alerts

Displays Control Panel Annunciation

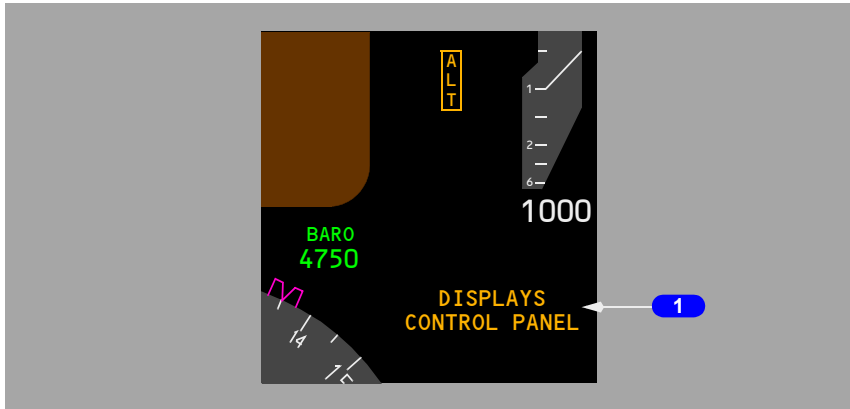

1 Displays Control Panel Annunciation (amber)

With the CONTROL PANEL select switch on the overhead panel in:

- BOTH ON 1 - left (Capt) EFIS control panel has failed
- NORMAL - corresponding EFIS control panel has failed
- BOTH ON 2 - right (F/O) EFIS control panel has failed.

Altitude information is removed.

Display System Annunciations

Note: The following annunciations occupy the same display location in the lower left corner of the primary flight display.

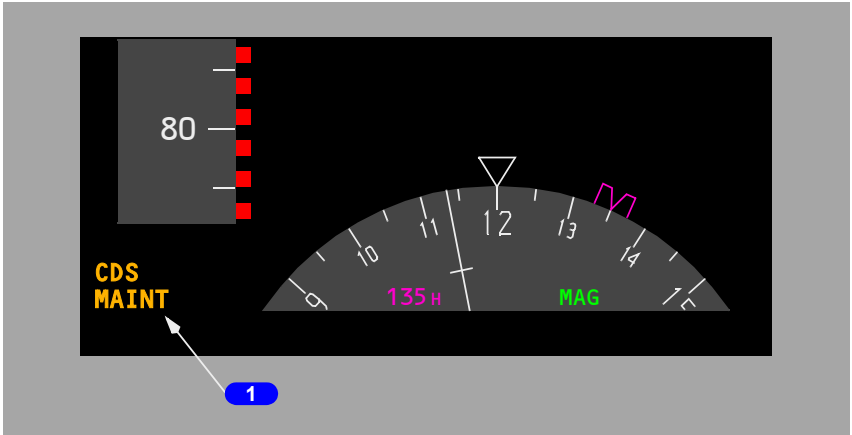

1 Display System Annunciations

DSPLY SOURCE (amber) – A single DEU has been selected, either manually or automatically, to drive all six display units.

- If the DEU fails on the same side as the engaged autopilot during climb or descent –
 - the flight director pitch command bars are removed from both pilots' displays. The pitch command bars reappear at ALT ACQ
 - the pitch mode reverts to CWS pitch
 - the autopilot remains engaged.
- If the DEU fails on the same side as the engaged autopilot during level flight –
 - climb or descent to a new MCP altitude is not possible in LVL CHG, VNAV, or V/S modes with the autopilot engaged.
- If the DEU fails on the opposite side as the engaged autopilot or while in manual F/D mode during climb or descent –
 - the flight director pitch command bar is removed from the pilot's display on the failed side until ALT ACQ
 - climb or descent is possible in LVL CHG, VNAV or V/S modes with the autopilot engaged.
- If the DEU fails on the same side as the engaged autopilot in the APPROACH mode –
 - the flight director pitch and roll command bars are removed from the pilot's display on the failed side.

CDS MAINT (white) – A dispatchable CDS fault has occurred. Displayed on the ground only, prior to start of the second engine.

CDS FAULT (amber) – A non–dispatchable CDS fault has occurred. Displayed on the ground only, prior to start of the second engine.

Instrument Switch Annunciation

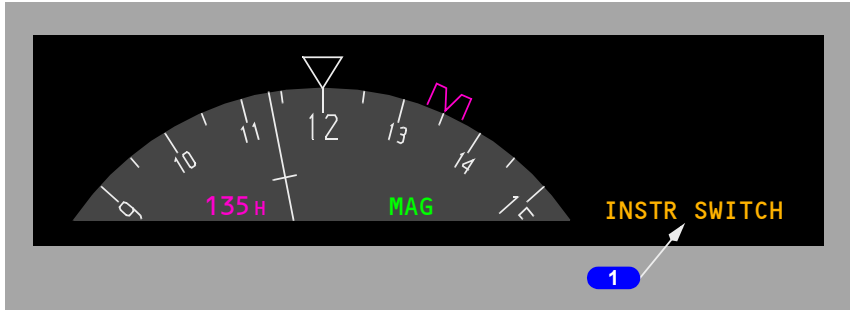

1 INSTR SWITCH Annunciation (amber)

Indicates both the Captain's and First Officer's displays are using the same source of IRU data.

Displayed when the IRS switch on the overhead panel is not in the NORMAL position.

Airspeed Disagree Alert

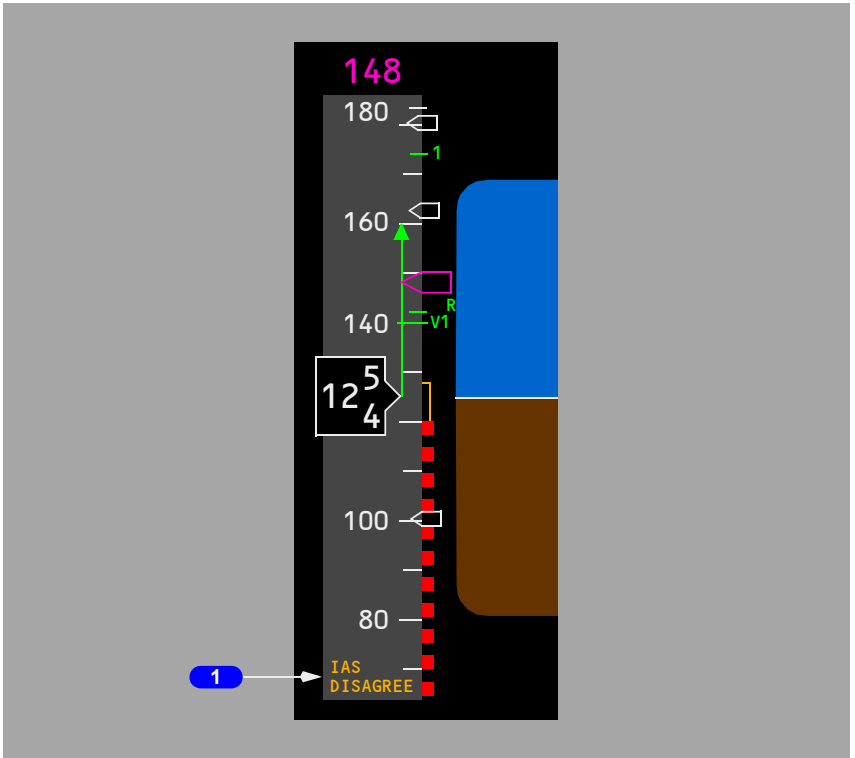

1 Airspeed Disagree Alert (amber)

Indicates the Captain's and F/O's airspeed indications disagree by more than 5 knots for 5 continuous seconds.

Altitude Disagree Alert

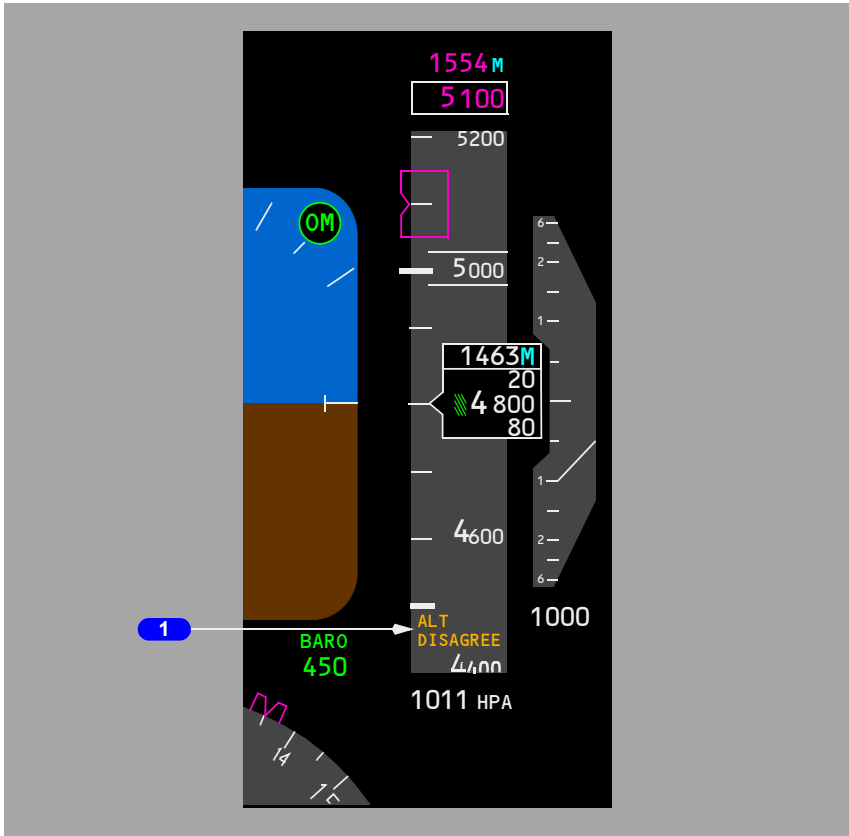

1 Altitude Disagree Alert (amber)

Indicates the Captain's and F/O's altitude indications disagree by more than 200 feet for more than 5 continuous seconds.

Navigation Displays – MAP Mode

Note: Refer to section 41 of this chapter for a detailed explanation of the navigation symbology shown on the following pages.

Expanded and Center MAP Modes

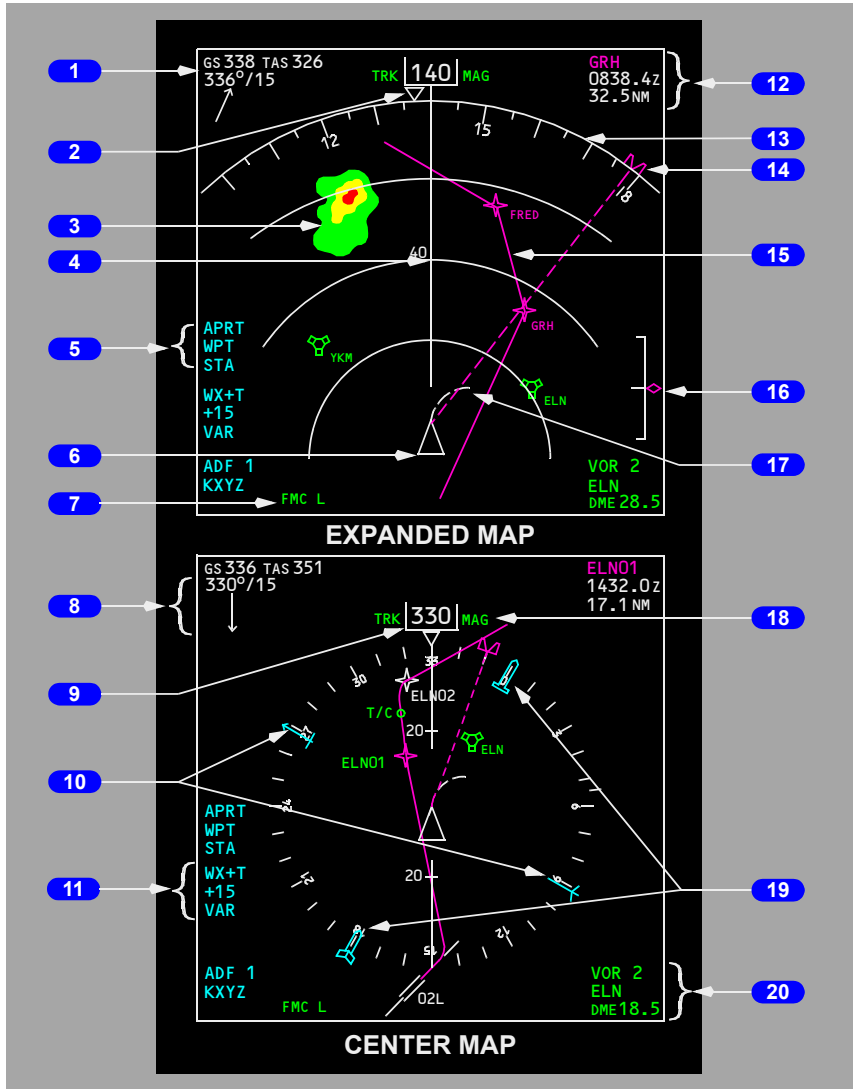

- 1** Groundspeed/True Airspeed
- 2** Heading Pointer
- 3** Weather Radar Returns
- 4** Track Line and Range Scale
- 5** Map Options
- 6** Airplane Symbol
- 7** Map Source Annunciation
- 8** Wind Direction/Speed/Arrow
- 9** Current Track
- 10** Number 1 VOR/ADF Pointer
- 11** Weather Radar Annunciations
- 12** Active Waypoint/ETA/Distance-To-Go
- 13** Compass Rose
- 14** Selected Heading Bug
- 15** Active LNAV Route
- 16** Vertical Deviation Scale and Pointer
- 17** Position Trend Vector
- 18** Magnetic/True Reference
- 19** Number 2 VOR Pointer
- 20** VOR/ADF Selection, Ident/Frequency, VOR DME

Navigation Displays – Approach Mode

Expanded and Center Approach Modes

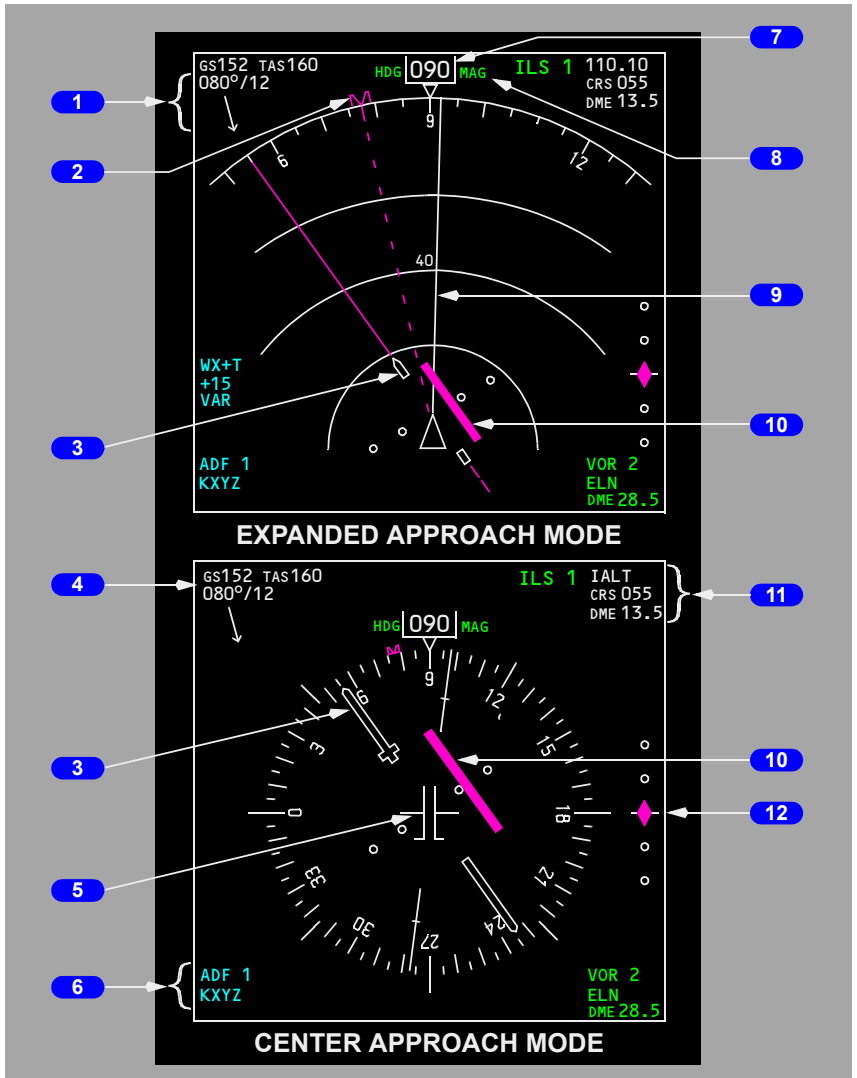

- 1** Wind Direction/Speed/Arrow
- 2** Selected Heading Bug
- 3** Selected Course Pointer
- 4** Groundspeed/True Airspeed
- 5** Airplane symbol
- 6** VOR/ADF Selection/Ident or Frequency/VOR DME
- 7** Current Heading
- 8** Magnetic/True Reference
- 9** Track Line
- 10** Localizer Deviation Indication and Scale
- 11** Reference ILS Frequency or Ident/Course/DME
- 12** Glideslope Pointer and Scale

Navigation Displays – VOR Mode

Expanded and Center VOR Modes

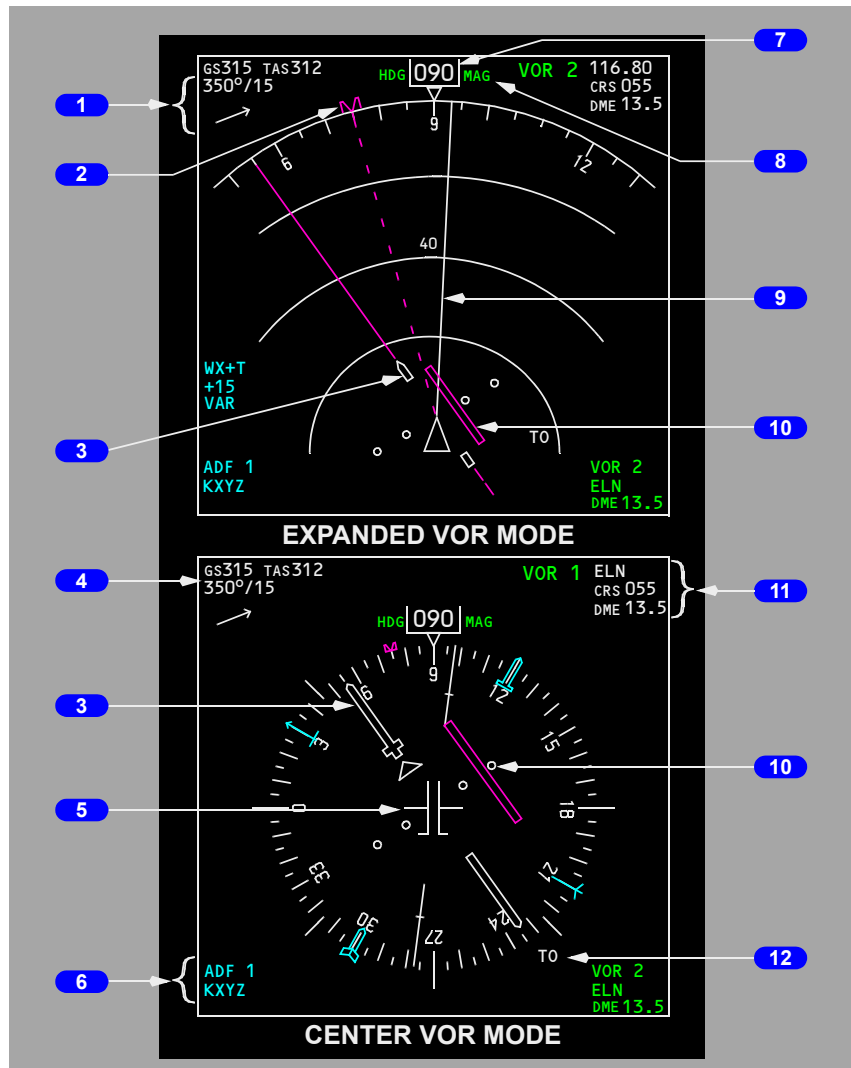

- 1** Wind Direction/Speed/Arrow
- 2** Selected Heading Bug
- 3** Selected Course Pointer
- 4** Groundspeed/True Airspeed
- 5** Airplane symbol
- 6** VOR/ADF Selection/Ident or Frequency/VOR DME
- 7** Current Heading
- 8** Magnetic/True Reference
- 9** Track Line
- 10** Course Deviation Indication and Scale
- 11** Reference VOR Receiver/Frequency or Ident/Course/DME
- 12** TO/FROM Indication and TO pointer

Navigation Displays – Plan Mode

Plan Mode

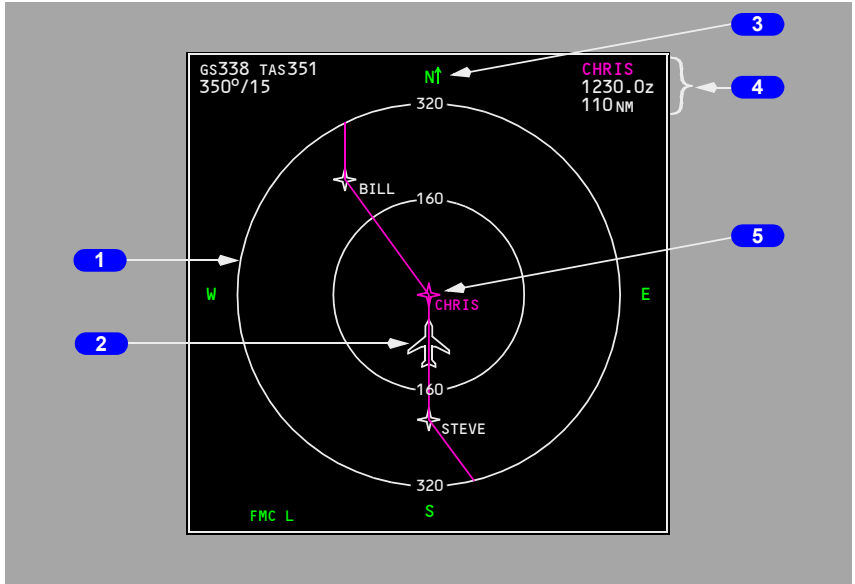

- 1** Range Circle
- 2** Airplane Symbol
- 3** True North Up Arrow
- 4** Active Waypoint Information
- 5** Center Waypoint

The waypoint located at the display center is identified as CTR on the CDU RTE LEGS page.

Navigation Displays – Advisory Messages

Navigation Advisory Messages

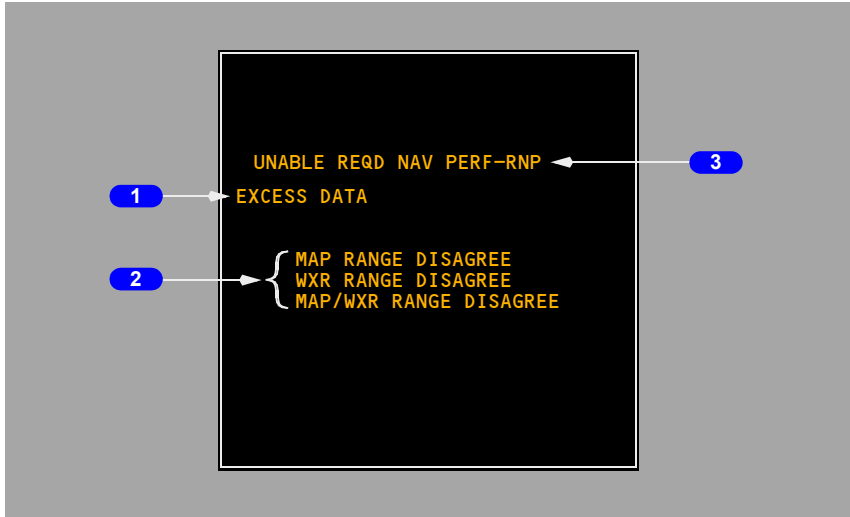

1 Excess Data Annunciation (amber)

The amount of map information sent to the primary display system is too great to display.

2 Range Disagreement Annunciations (amber)

MAP RANGE DISAGREE – Indicates selected range on the EFIS control panel is different than the MAP display range.

WXR RANGE DISAGREE – Indicates selected range on the EFIS control panel is different than the WXR display range.

MAP/WXR RANGE DISAGREE – Indicates selected range on the EFIS control panel is different than the MAP and WXR display ranges.

3 Nav Advisory Message (amber)

UNABLE REQD NAV PERF-RNP – Displayed in MAP or Center MAP during approach. Refer to Chapter 11 section 60, FMC Messages.

Mode/Frequency Disagree Annunciation

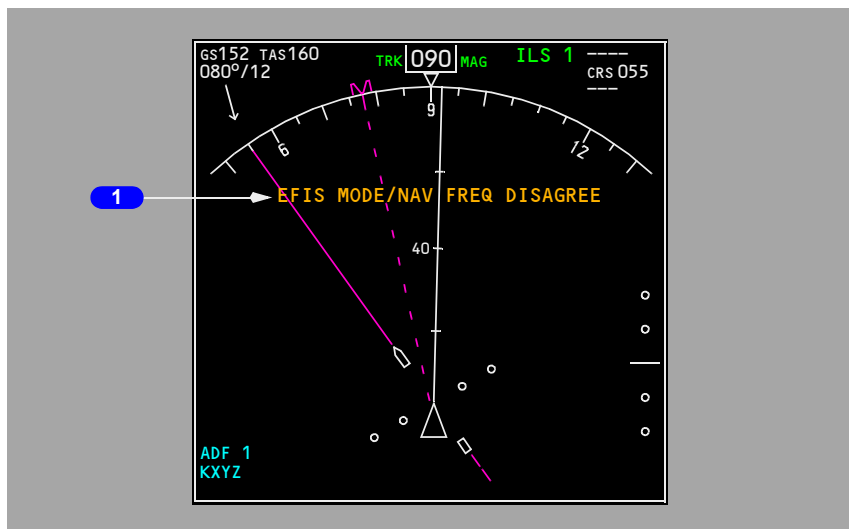

1 EFIS MODE/NAV FREQ DISAGREE (amber)

The ILS or VOR source annunciation corresponds to the position selected on the EFIS control panel and the tuned VOR/ILS frequency.

The annunciation is displayed:

- if APP is selected with a VOR frequency tuned
- if VOR is selected with an ILS frequency tuned.

The DME display and ILS/VOR frequency at the upper right corner display dashes.

The localizer deviation bar, VOR course deviation bar and glide slope pointer are not displayed.

The annunciation is displayed in the expanded APP, center APP, expanded VOR and center VOR modes.

TCAS Messages



1 TCAS Traffic Symbols

Note: Refer to section 41 of this chapter for a detailed explanation of the traffic symbology.

Indicates position of traffic targets.

Displayed in expanded MAP, center MAP, expanded APP and expanded VOR modes and TFC is selected on the EFIS control panel.

2 TCAS Annunciations

TFC (cyan) – Indicates TFC selected on EFIS control panel in expanded MAP, center MAP, expanded APP and expanded VOR.

TCAS TEST (cyan) – TCAS in test mode.

TA ONLY (cyan) – TCAS TA mode only.

TCAS OFF (amber) – TCAS off.

3 Offscale (red or amber)

TA (amber) or RA (red) is beyond the selected display range and TFC is selected on the EFIS control panel.

4 Traffic (red or amber)

Displayed during a TA (amber) or RA (red) condition whether or not TFC is selected on the EFIS control panel.

5 No-Bearing Messages (red or amber)

Textual description of TA (amber) or RA (red) traffic with no associated bearing. Message provides traffic type, range in NM, altitude and a vertical motion arrow. A maximum of two messages can be displayed simultaneously. TFC selected on the EFIS control panel.

Look-Ahead Terrain Messages (GPWS)

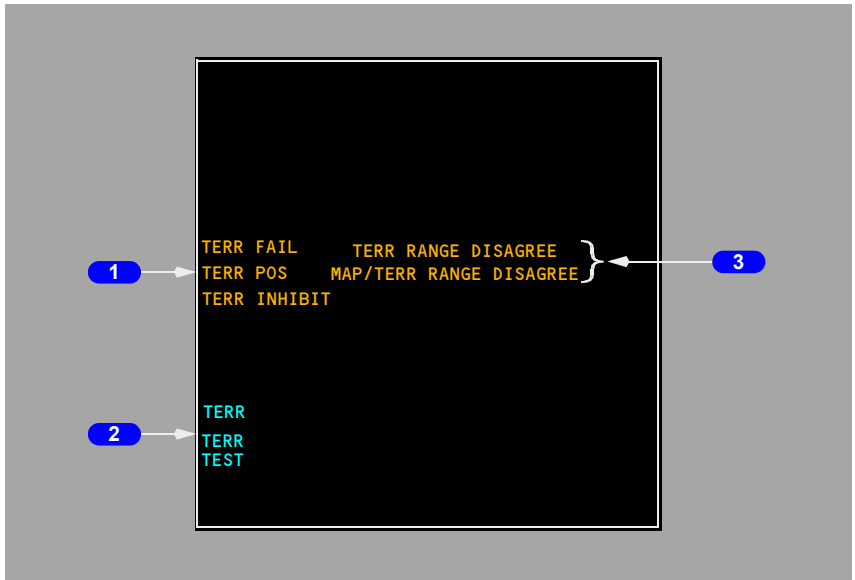

1 Terrain Status Annunciation (amber)

TERR FAIL – Look-ahead terrain alerting and display have failed.
TERR POSS – Look-ahead terrain alerting and display unavailable due to position uncertainty.
TERR INHIBIT – GPWS terrain inhibit switch in TERR INHIBIT position.

2 Terrain Mode Annunciation (cyan)

TERR – Terrain display enabled (manual or automatic display).
TERR TEST – GPWS is operating in self-test mode.

3 Terrain Range Status Annunciation (amber)

TERR RANGE DISAGREE –

- terrain display enabled, and
- terrain output range disagrees with selected EFIS control panel range.

MAP/TERR RANGE DISAGREE –

- terrain display enabled, and
- terrain output range disagrees with selected EFIS control panel range, and
- map display output range disagrees with selected EFIS control panel range.

Predictive Windshear System (PWS) Message

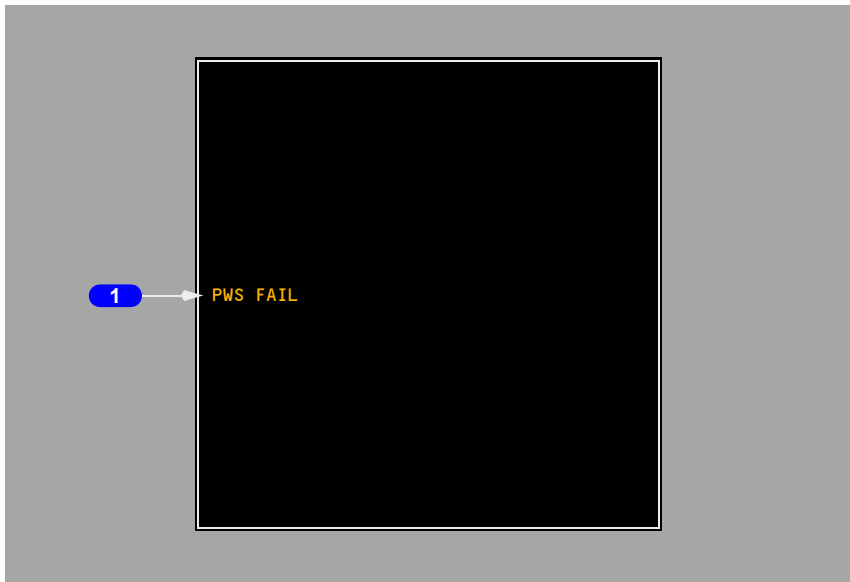

1 PWS FAIL Annunciation (amber)

Predictive windshear alerting and display have failed.

Navigation Displays – Failure Indications and Flags

Dashes replace numbers if there is no computed information. Failure flags replace symbols or failure messages are displayed, as appropriate.

Expanded MAP, Center MAP, Expanded APP, Expanded VOR Modes

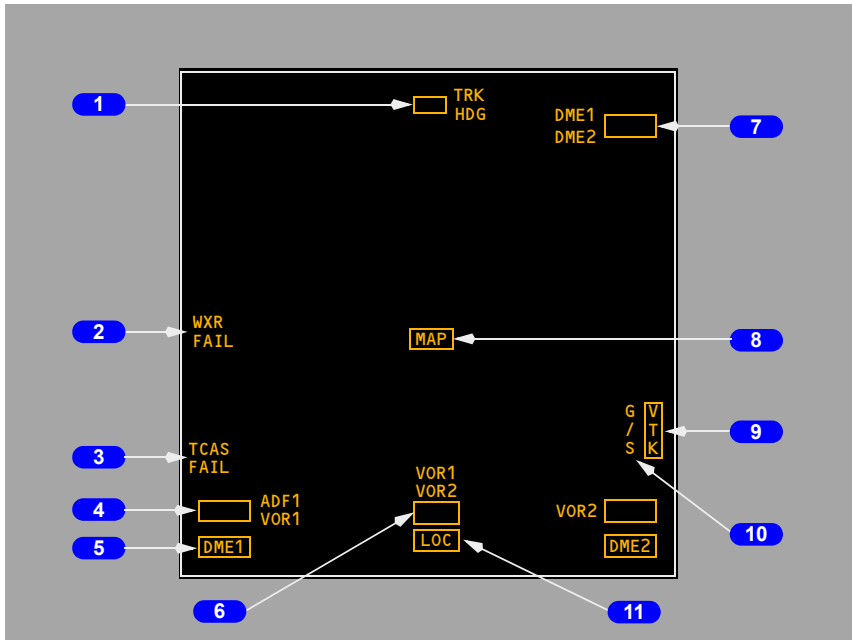

1 Track Failure Flag (expanded and center MAP modes)

Track or heading display has failed.

2 Weather Radar Annunciations (expanded and center MAP, expanded APP, expanded VOR modes)

WXR FAIL – Weather radar has failed. No weather data are displayed.

WXR WEAK – Weather radar calibration fault.

WXR ATT – Attitude stabilization for antenna has been lost.

WXR STAB – Antenna stabilization is off.

WXR DSP – Range data input has failed. Only displayed in WXR TEST

3 TCAS Failure Flag (expanded and center MAP, expanded VOR, expanded APP, PLAN modes)

TCAS has failed.

4 ADF 1 or VOR 1 and VOR 2 Failure Flag (expanded and center MAP, expanded APP, expanded VOR modes)

ADF or VOR display has failed.

5 DME 1 and DME 2 Failure Flag (expanded and center MAP, expanded APP, expanded VOR modes)

Selected VOR DME display has failed.

6 VOR 1, 2 Failure Flag (expanded VOR mode)

VOR display has failed.

7 Reference VOR DME (expanded VOR mode) and Reference ILS DME (expanded APP mode)

Reference VOR or ILS DME display has failed.

8 MAP Failure Flag (expanded and center MAP, PLAN modes)

The related FMC generated map display has failed.

9 Vertical Track Failure Flag (expanded and center MAP modes)

FMC vertical track data are invalid.

10 ILS Glideslope Failure Flag (expanded APP mode)

ILS glideslope display has failed.

11 ILS Localizer Failure Flag (expanded APP mode)

ILS localizer display has failed.

ND Failure Flags – Center APP and Center VOR Modes

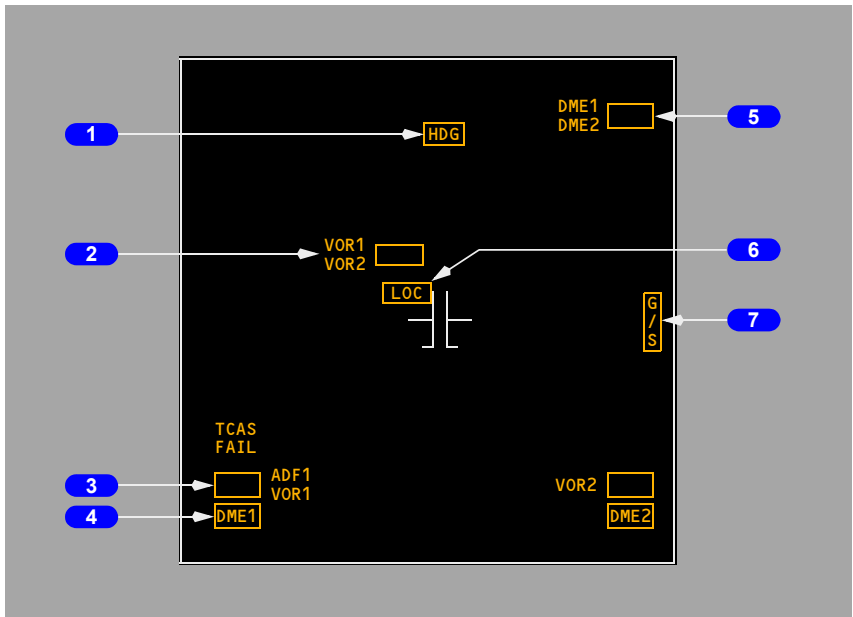

1 Heading Failure Flag (center APP, center VOR modes)

Heading display has failed.

2 VOR Failure Flag (center VOR mode)

VOR display has failed.

3 ADF 1 or VOR 1 and VOR 2 Failure Flag (center APP, center VOR modes)

VOR or ADF display has failed.

4 DME 1 and DME 2 Failure Flag (center APP, center VOR modes)

Selected VOR DME display has failed.

5 Reference VOR DME (center VOR mode) and Reference ILS DME (center APP mode)

Reference VOR or ILS DME display has failed.

6 ILS Localizer Failure Flag (center APP mode)

ILS localizer display has failed.

7 ILS Glideslope Failure Flag (center APP mode)

ILS glide slope display has failed.

This Section Applies to YA371, YA372, YC201

EFIS Control Panel (EFIS/Map Display)

The left EFIS control panel controls the Captain outboard and inboard display units. The right EFIS control panel controls the First Officer outboard and inboard display units.

EFIS Control Panel Controls – Flight Instrument Displays

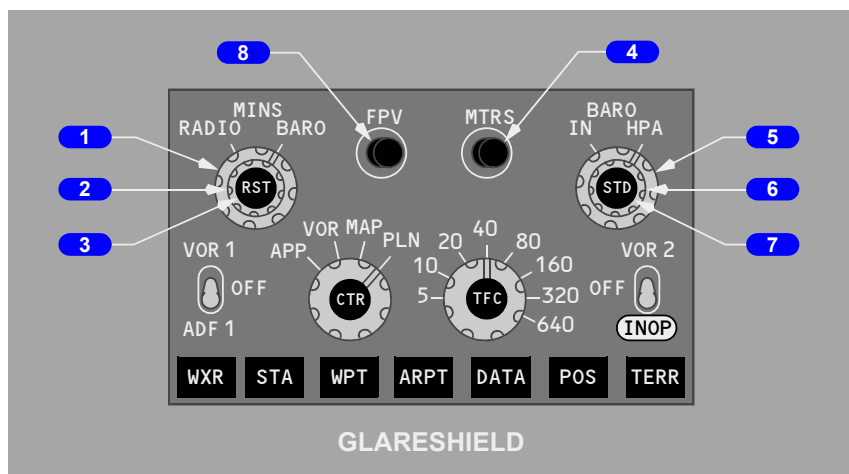

1 Minimums (MINS) Reference Selector (outer) (two position)

RADIO – selects radio altitude as the minimums reference.

BARO – selects barometric altitude as the minimums reference.

2 Minimums (MINS) Selector (middle) (slew)

ROTATE – adjusts the radio or baro minimums altitude.

3 Minimums (MINS) Reset (RST) Switch (inner) (momentary action)

PUSH –

- blanks radio height ALT alert
- resets the radio altitude minimums alert display on the attitude indicator
- blanks the reference altitude marker on the altimeter if displayed; sets the reference altitude marker to zero if not previously displayed.

4 Meters (MTRS) Switch (momentary action)

PUSH – displays altitude indications in meters. Not available in compact display format.

5 Barometric (BARO) Reference Selector (outer) (two position)

IN – selects inches of mercury as the barometric altitude reference.
HPA – selects hectopascals as the barometric altitude reference.

6 Barometric (BARO) Selector (middle) (slew)

ROTATE – adjusts the barometric altitude setting on the altimeter.

7 Barometric (BARO) Standard (STD) Switch (inner) (momentary action)

PUSH – selects the standard barometric setting (29.92 inches Hg/1013 HPA) for barometric altitude reference.

8 Flight Path Vector (FPV) Switch (momentary action)

PUSH – displays flight path vector and horizon line heading scale on the attitude indicator.

EFIS Control Panel Controls – Navigation Displays

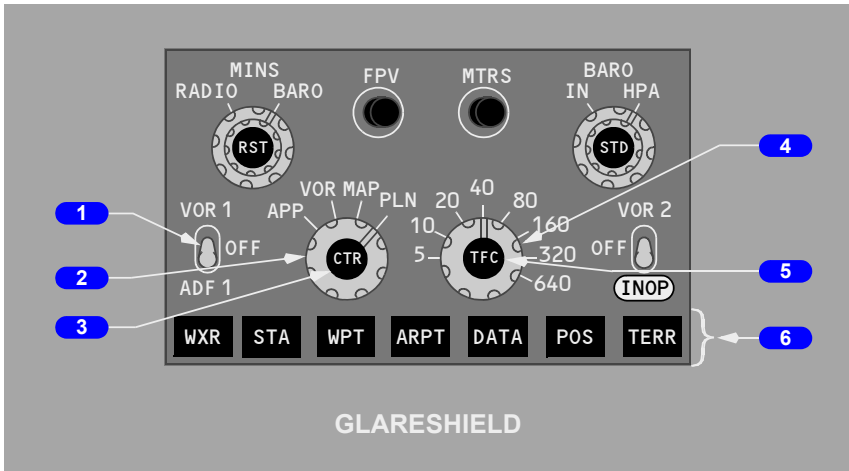

1 VOR/ADF Switch (three position)

Displays VOR or ADF information on the respective RDMI.

VOR – displays the selected VOR bearing pointer and VOR bearing pointer source indicator.

OFF – removes the VOR or ADF displays and displays “OFF” in place of the bearing pointer source indicators.

ADF – displays the selected ADF pointer and ADF bearing pointer source indicator.

2 Mode Selector (outer)

Selects the desired display.

APP –

- displays localizer and glideslope information in heading–up format
- displays reference ILS receiver, ILS frequency, course and DME
- weather radar and TCAS are not displayed in center APP mode.

VOR –

- displays VOR navigation information in heading–up format
- displays reference VOR receiver, VOR frequency, course, DME and TO/FROM information
- weather radar and TCAS are not displayed in center VOR mode.

MAP –

- displays FMC generated route and MAP information, airplane position, heading and track, in a track–up format
- displays waypoints, including the active waypoint, within the selected range
- displays VNAV path deviation.

PLN –

- displays a non–moving, true north up, route depiction
- the airplane symbol represents actual airplane position
- allows route step–through using the CDU LEGS page
- weather radar and TCAS are not displayed.

3 Center (CTR) Switch (inner)

PUSH –

- displays the full compass rose (center) for APP, VOR and MAP modes
- subsequent pushes alternate between expanded and center displays.

4 Range Selector (outer)

Selects desired display range in nautical miles for APP, VOR, MAP or PLN mode.

5 Traffic (TFC) Switch (inner)

PUSH – displays TCAS information (refer to Chapter 15, Warning Systems).

6 MAP Switches (momentary action)

The MAP switches:

- add background data/symbols to MAP and center MAP modes
- displays can be selected simultaneously
- second push removes the information.

WXR (weather radar) – energizes weather radar transmitter and displays weather radar returns in MAP, center MAP, expanded VOR and expanded APP modes. When the 640 nm range is selected, weather radar returns are limited to 320 nm (refer to Chapter 11, Flight Management, Navigation).

STA (station) –

- displays all FMC data base navigation aids if on map scales 5, 10, 20 or 40 nm.
- displays FMC data base high altitude navigation aids on map scales 80, 160, 320 or 640 nm.

WPT (waypoint) – displays the waypoints in the FMC data base which are not in the flight plan route if the selected range is 40 nm or less.

ARPT (airport) – displays all airports which are stored in the FMC data base and which are within the viewable map area.

DATA – displays altitude constraint, if applicable, and estimated time of arrival for each active route waypoint.

POS (position) – displays VOR and ADF bearing vectors extended from the nose of the airplane symbol to the stations.

TERR (terrain) – displays GPWS generated terrain data in MAP, center MAP, VOR, and APP modes (refer to Chapter 15, Warning Systems).

Displays Source Panel

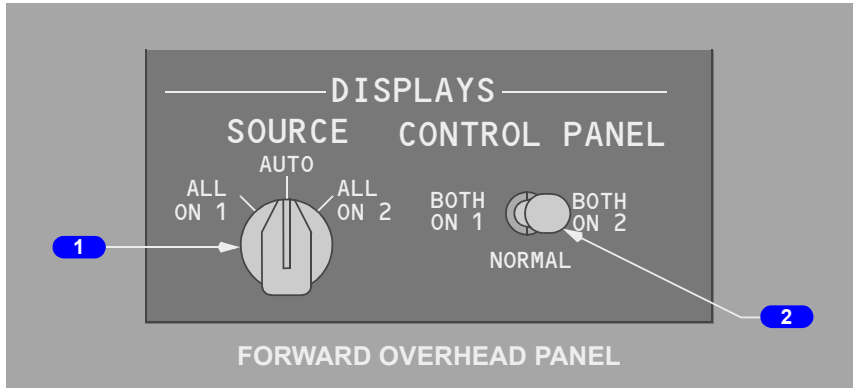

1 DISPLAYS SOURCE Selector

AUTO – DEU 1 controls the Captain outboard, Captain inboard, and the upper display units; DEU 2 controls the First Officer outboard, First Officer inboard, and the lower display units. When a DEU fails, the other DEU controls all display units.

ALL ON 1/ALL ON 2 – provides a means of manually switching to a single DEU as the source of information for all six display units.

Note: Used on the ground for maintenance purposes.

2 CONTROL PANEL Select Switch

NORMAL – the left EFIS control panel controls the Captain’s displays and the right EFIS control panel controls the First Officer’s displays.

BOTH ON 1/BOTH ON 2 – provides a means of manually switching control of the Captain’s and First Officer’s displays to a single EFIS control panel.

Display Select Panels

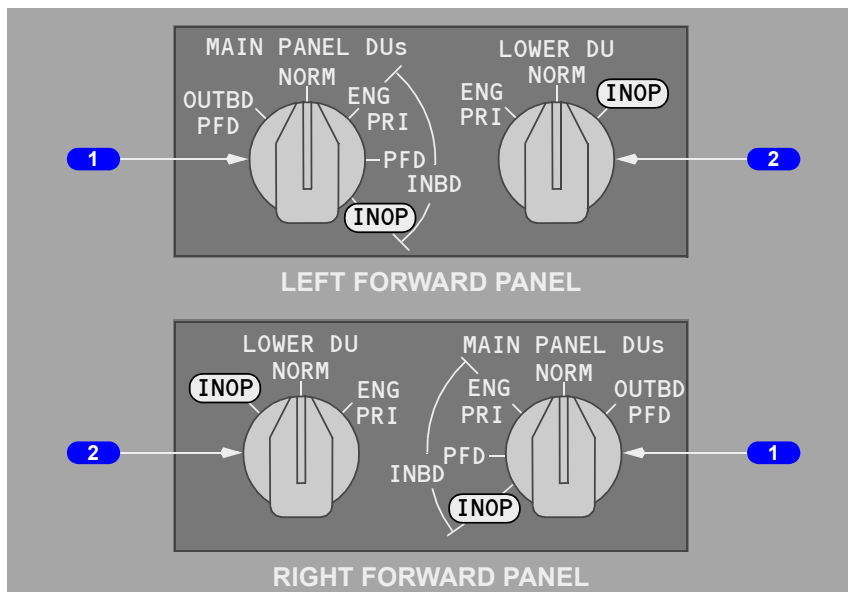

1 Main Panel Display Units (MAIN PANEL DUs) Selector

Selects what is displayed on the respective outboard and inboard display units:

- Outboard Primary Flight Display (OUTBD PFD) – displays the compact EFIS format on the outboard display unit and blanks the inboard display unit.
- Normal (NORM) – displays normal EFIS and MAP displays on the outboard and inboard display units; provides automatic display switching if a display unit fails.
- Inboard Engine Primary (INBD ENG PRI) – displays the engine display on the inboard display unit and the compact EFIS format on the outboard display unit.
- Inboard Primary Flight Display (INBD PFD) – displays the compact EFIS format on the inboard display unit and blanks the outboard display unit.

2 Lower Display Unit (LOWER DU) Selector

Selects what is displayed on the lower display unit:

- Engine Primary (ENG PRI) – displays the engine display on the lower display unit and blanks the upper display unit.
- Normal (NORM) – displays the engine display on the upper display unit and no display on the lower display unit; provides automatic display switching to the lower display unit if the upper display unit fails.

Speed Reference Selector

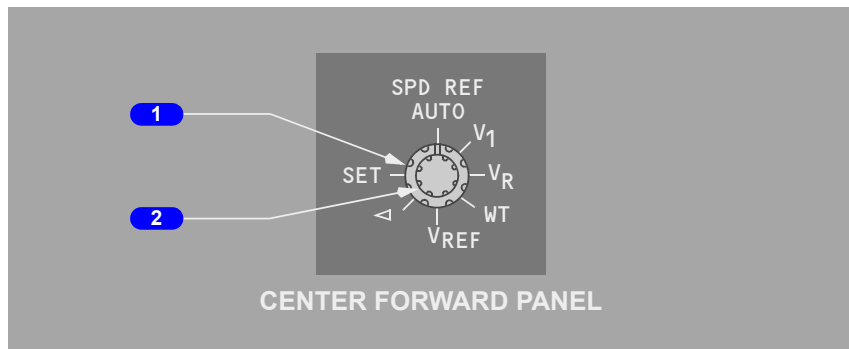

1 Speed Reference Selector (outer)

Sets the reference airspeed bugs on the Mach/airspeed indicator:

- AUTO – the reference airspeeds and gross weight are provided automatically through the FMC
- V1 – used to manually set decision speed on the ground; in flight, displays “INVALID ENTRY”
- VR – used to manually set rotation speed on the ground; in flight, displays “INVALID ENTRY”
- WT – allows manual entry of reference gross weight
- VREF – used to manually set the landing reference speed in flight; on the ground, displays “INVALID ENTRY”
- Bug 5 – used to manually set the white bug 5 to the desired value
- SET – removes the digital readout above the Mach/airspeed indicator.

2 Speed Reference Selector (inner) (two speed slew)

ROTATE –

- manually sets the appropriate reference airspeed or gross weight
- the digital display appears above the Mach/airspeed indicator.

Display Brightness Controls

Captain Brightness Controls

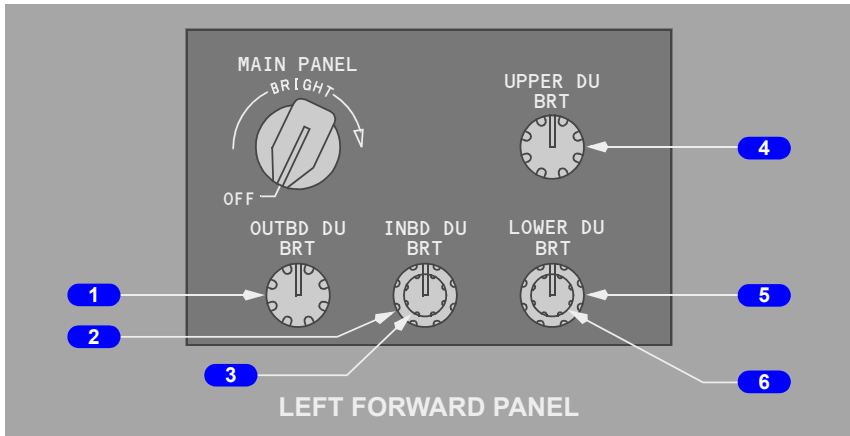

- 1 Outboard Display Unit Brightness (OUTBD DU BRT) Control (rotary)**

ROTATE – adjusts the brightness of the Captain outboard display unit.

- 2 Inboard Display Unit Brightness (INBD DU BRT) Control (outer) (rotary)**

ROTATE – adjusts the brightness of the Captain inboard display unit.

- 3 Inboard Display Unit Radar Brightness (INBD DU BRT) Control (inner) (rotary)**

ROTATE – adjusts weather radar and terrain display brightness on the Captain inboard display unit.

- 4 Upper Display Unit Brightness (UPPER DU BRT) Control (rotary)**

ROTATE – adjusts the brightness of the upper display unit.

- 5 Lower Display Unit Brightness (LOWER DU BRT) Control (outer) (rotary)**

ROTATE – adjusts the brightness of the lower display unit.

- 6 Lower Display Unit Brightness (LOWER DU BRT) Control (inner) (rotary)**

Inoperative.

First Officer Brightness Controls

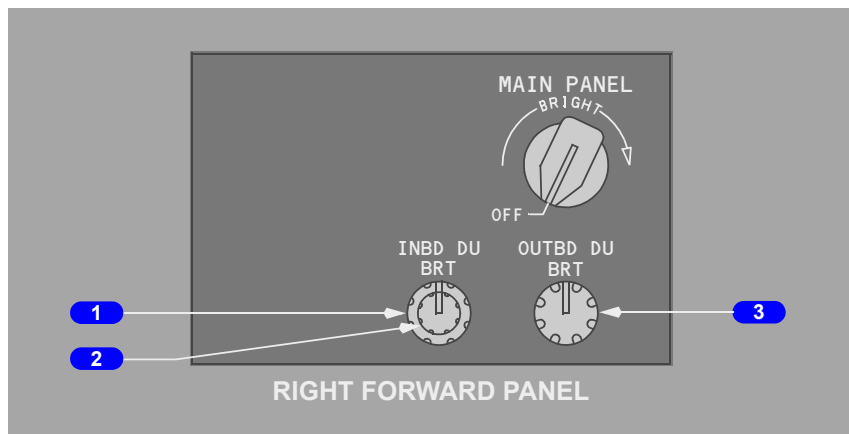

1 Inboard Display Unit Brightness (INBD DU BRT) Control (outer) (rotary)

ROTATE – adjusts the brightness of the First Officer inboard display unit.

2 Inboard Display Unit Radar Brightness (INBD DU BRT) Control (inner) (rotary)

ROTATE – adjusts weather radar and terrain display brightness on the First Officer inboard display unit.

3 Outboard Display Unit Brightness (OUTBD DU BRT) Control (rotary)

ROTATE – adjusts the brightness of the First Officer outboard display unit.

Standby Flight Instruments

The standby flight instruments include the:

- standby magnetic compass
- integrated standby flight display
- standby radio magnetic indicator.

Standby Magnetic Compass

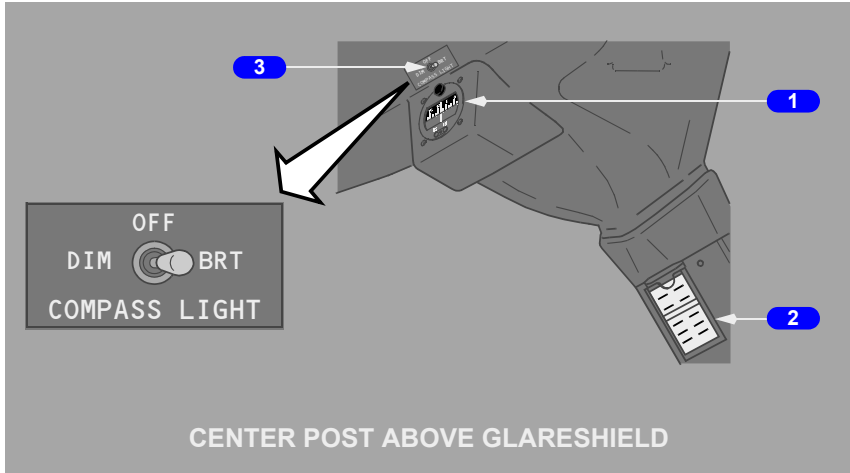

1 Standby Magnetic Compass

Displays magnetic heading.

2 Standby Magnetic Compass Correction Card

Provides appropriate heading corrections.

3 Compass Light Switch

OFF – compass light is extinguished.

BRT – sets compass light to full brightness.

DIM – sets compass light to low brightness.

Integrated Standby Flight Display

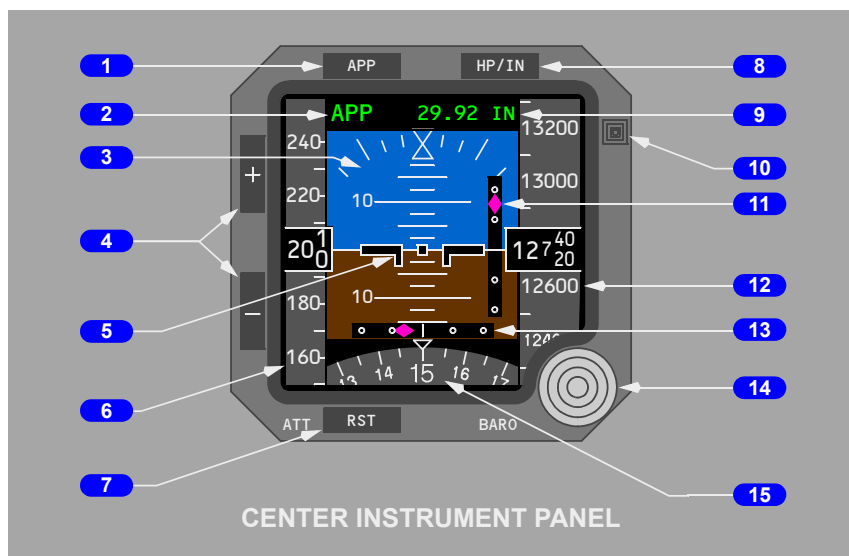

1 Approach (APP) Switch

Push –

- when blank, selects APP
- when APP displayed, selects BCRS
- when BCRS displayed, blanks

2 Approach Mode Annunciation

Indicates approach mode selected.

- Blank – no approach deviation data displayed
- APP – ILS localizer and glideslope deviation data displayed
- BCRS (Back course) – reverses sensing for localizer pointer during back course approaches

3 Attitude Display

Displays airplane attitude.

- Indicates bank in reference to the bank scale
- Indicates the horizon relative to the airplane symbol
- Beyond 30 degrees pitch, large red arrowheads (V-shaped) indicate the attitude has become excessive, and the direction to the horizon line.

4 Display Brightness Switches

Push –

- + increases display brightness
- - decreases display brightness

5 Airplane Symbol

Indicates airplane attitude with reference to the horizon.

6 Airspeed Indications

Indicates current airspeed when above 30 knots.

7 Attitude Reset (RST) Switch

Push and hold at least two seconds

- aligns horizon with the airplane symbol
- reset takes approximately ten seconds

8 Hectopascal/Inch (HP/IN) Switch

Push – changes the units of the barometric reference.

9 Barometric Setting

Indicates the barometric setting selected with the barometric selector.

STD is displayed when selected with the barometric selector.

10 Ambient Light Sensor

Automatically adjusts display intensity for ambient lighting condition.

11 Glideslope Pointer and Deviation Scale

The glideslope pointer indicates glideslope position relative to the airplane.

- the pointer is in view when the glideslope signal is received
- the scale is in view when the APP mode is selected
- the pointer and scale are removed when the BCRS mode is selected

12 Current Altitude

13 Localizer Pointer and Deviation Scale

The localizer pointer indicates localizer position relative to the airplane.

- the pointer is in view when the localizer signal is received
- the scale is in view when either the APP or BCRS mode is selected

14 Barometric (BARO) Selector

Rotate – changes barometric setting

Push –

- selects standard barometric setting (29.92 inches Hg/1013 HPA)
- if STD is displayed, selects the preselected barometric setting

15 Heading Indication

Displays airplane heading.

ISFD Messages

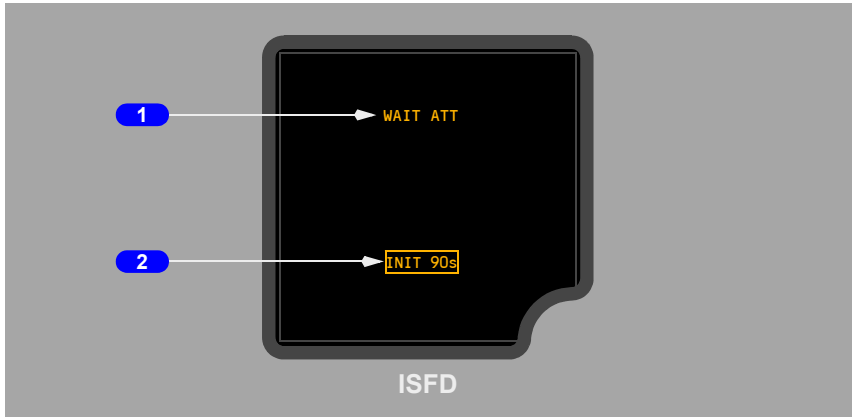

1 Attitude Messages

Indicates attitude display status.

- ATT:RST (amber) – attitude must be reset using the attitude reset switch
- ATT 10s (amber) – 10 second attitude realignment in progress
- WAIT ATT (amber) – indicates temporary self correcting loss of attitude

2 Initialization Message

INIT 90s (amber) – 90 second initialization in progress.

ISFD Failure Flags

The OUT OF ORDER annunciation replaces the display when a total ISFD system failure occurs.

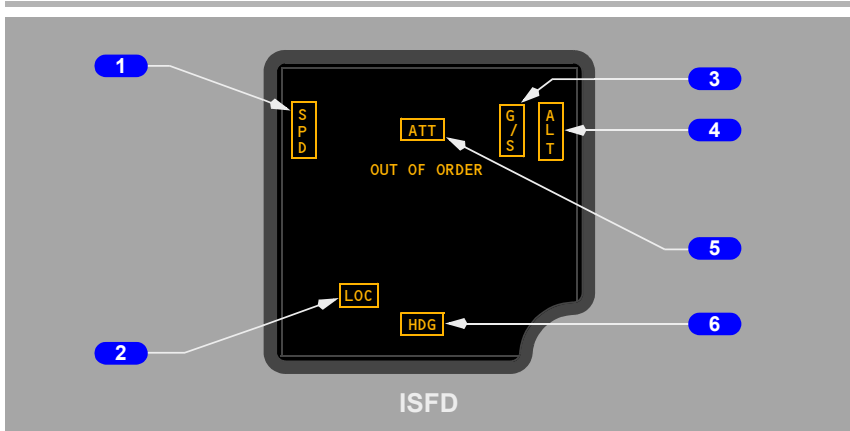

1 Airspeed flag

Airspeed information has failed.

2 ILS localizer failure flag

ILS localizer has failed.

3 ILS glideslope failure flag

ILS glideslope has failed.

4 Altitude flag

Altitude information has failed.

5 Attitude flag

Attitude information has failed.

6 Heading flag

Heading data has failed.

Standby Radio Magnetic Indicator

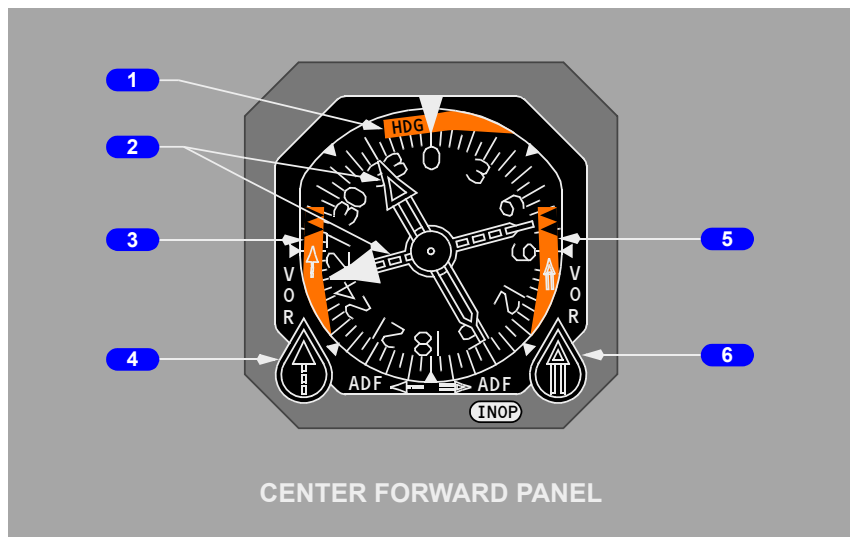

1 Heading Warning Flag

The compass signal from the air data inertial reference system is lost.

2 Bearing Pointers

- narrow pointer uses signals from the VHF NAV receiver No. 1 or ADF receiver No. 1.
- wide pointer uses signals from the VHF NAV receiver No. 2.

3 Bearing Pointer No. 1 Warning Flag

VOR mode:

- RMI power failure
- VHF NAV signal unreliable.

ADF mode:

- RMI power failure
- ADF failure or signal unreliable.

4 VOR/ADF Bearing Pointer No. 1 Switch

ROTATE – selects VOR or ADF for the bearing pointer.

5 Bearing Pointer No. 2 Warning Flag

VOR mode

- RMI power failure
- VHF NAV signal unreliable.

6 VOR Bearing Pointer No. 2 Switch

ROTATE – selects VOR for the bearing pointer.

Clock

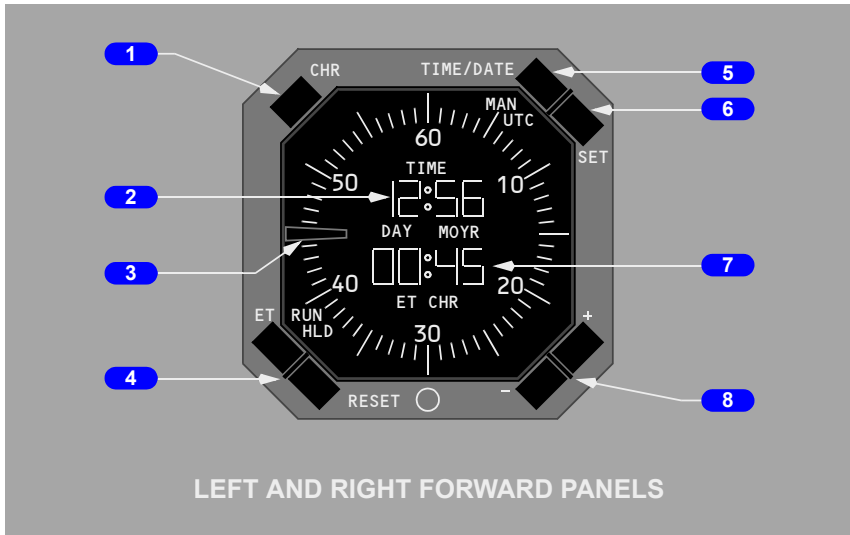

1 Chronograph (CHR) Control

PUSH –

- controls the start, stop and reset functions of the CHR display and second hand with successive pushing
- overrides any existing ET display.

2 Time/Date Indicator

- displays UTC or manual time (hours, minutes) when time is selected with the time/date pushbutton
- alternately displays day–month and year when date is selected with the time/date pushbutton.

3 Chronograph Second Hand

- indicates chronograph seconds
- controlled by the CHR control

4 Elapsed Time (ET) and RESET Pushbutton

Controls the elapsed time function.

- select the ET pushbutton once to run the elapsed time
- select the ET pushbutton again to hold the elapsed time
- select the RESET pushbutton to set the elapsed time to 0.

The RUN or HLD symbol is displayed on the lower left part of the LCD display.

5 TIME/DATE Pushbutton

Controls the time/date function.

- select the TIME/DATE pushbutton once to see UTC time
- select the TIME/DATE pushbutton again to see UTC date
- select the TIME/DATE pushbutton again to see manual time
- select the TIME/DATE pushbutton again to see manual date.

The UTC or MAN symbol is displayed on the upper right part of the LCD display.

In MAN mode, clock time and date come from the clock. In UTC mode, clock time and date come from the global positioning system.

6 SET Pushbutton

Controls the setting of manual time and date.

With manual time displayed:

- select the SET pushbutton once and the hours flash, use the plus or minus pushbutton to adjust the hours
- select the SET pushbutton again and the minutes flash, use the plus or minus pushbutton to adjust the minutes
- select the SET pushbutton again to run the time.

With manual date displayed:

- select the SET pushbutton once and the day flashes, use the plus or minus pushbutton to adjust the day
- select the SET pushbutton again and the month flashes, use the plus or minus pushbutton to adjust the month
- select the SET pushbutton again and the year flashes, use the plus or minus pushbutton to adjust the year
- select the SET pushbutton again to run the date.

Note: A delay greater than one minute while setting the time or date results in the clock reverting to the previous time/date setting.

7 Elapsed Time (ET)/Chronograph Indicator

- displays elapsed time (hours, minutes) or chronograph minutes
- the chronograph display replaces the elapsed time display
- elapsed time continues to run in the background and displays after the chronograph is reset.

8 Plus (+) and Minus (-) Pushbuttons

Used to set the manual time and date

- select the + pushbutton to increase the value
- select the - pushbutton to decrease the value.

Flight Recorder

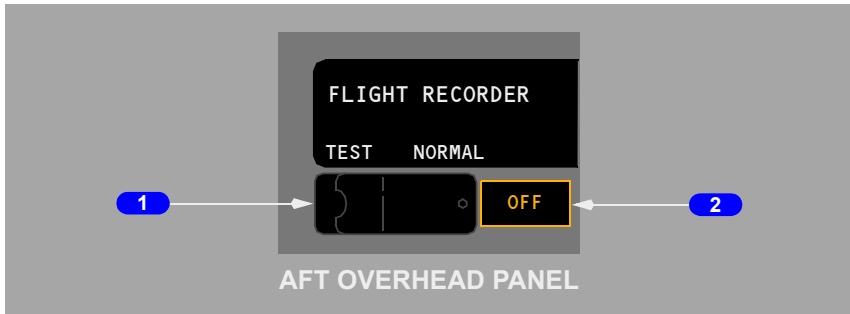

1 Flight Recorder Test Switch

NORMAL (guarded position) –

- inflight – the recorder operates anytime electrical power is available
- on the ground – either engine must also be operating.

TEST – powers the flight recorder on the ground.

2 OFF Light (amber)

ILLUMINATED –

- indicates the recorder is not operating or the test is invalid
- may indicate power failure, loss of input data, or electronic malfunction.

This Section Applies to YA373 - YA377, YC202 - YE326

EFIS Control Panel (PFD/ND Display)

The left EFIS control panel controls the Captain outboard and inboard display units. The right EFIS control panel controls the First Officer outboard and inboard display units.

EFIS Control Panel Controls – Flight Instrument Displays

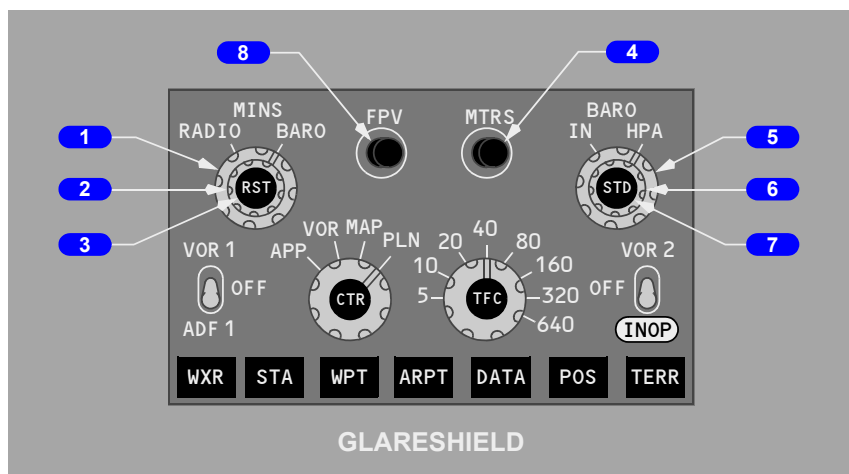

1 Minimums (MINS) Reference Selector (outer) (two position)

RADIO – selects radio altitude as the minimums reference

BARO – selects barometric altitude as the minimums reference.

2 Minimums (MINS) Selector (middle) (slew)

ROTATE – adjusts the radio or baro minimums altitude.

3 Radio Minimums (MINS) Reset (RST) Switch (inner) (momentary action)

PUSH –

- resets the alert minimums annunciation
- blanks minimums display if alert is not active.

4 Meters (MTRS) Switch (momentary action)

PUSH – displays altitude indications in meters.

5 Barometric (BARO) Reference Selector (outer) (two position)

IN – selects inches of mercury as the barometric altitude reference

HPA – selects hectopascals as the barometric altitude reference.

6 Barometric (BARO) Selector (middle) (slew)

ROTATE –

- adjusts the barometric altitude setting on the altitude tape
- if STD displayed, adjusts the preselected BARO reference.

7 Barometric (BARO) Standard (STD) Switch (inner) (momentary action)

PUSH –

- selects the standard barometric setting (29.92 inches Hg/1013 HPA) for barometric altitude reference
- if STD is displayed, selects the preselected barometric reference
- if no preselected barometric is displayed, displays the last value before STD was selected.

8 Flight Path Vector (FPV) Switch (momentary action)

YA373 - YA377, YC202 - YC207, YE324 - YE326

PUSH – displays flight path vector on the attitude indicator.

YE321 - YE323

PUSH – displays flight path vector and horizon line heading scale on the attitude indicator.

EFIS Control Panel Controls – Navigation Displays

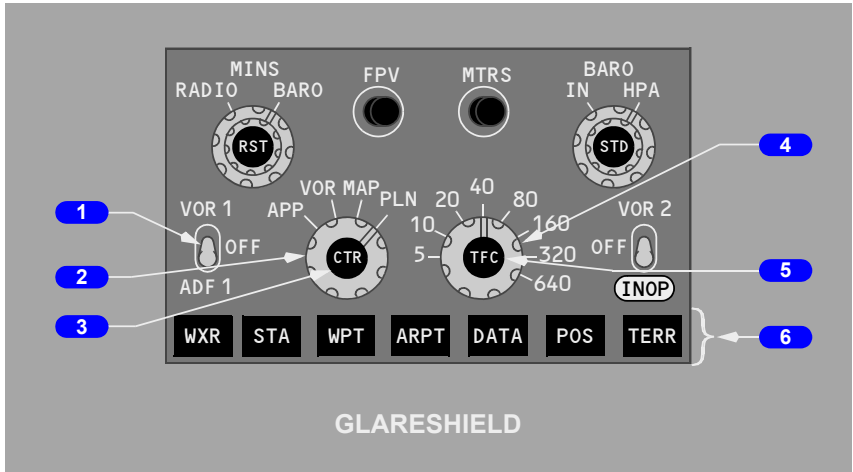

1 VOR/ADF Switch (three position)

Displays VOR or ADF information on all navigation modes except PLAN.

VOR – displays the selected VOR bearing pointer, frequency or identification and DME.

OFF – removes the VOR or ADF displays.

ADF – displays the selected ADF pointer and ADF frequency or identification.

2 Mode Selector (outer)

Selects the desired display.

APP –

- displays localizer and glideslope information in heading–up format.
- displays reference ILS receiver, ILS frequency or identification, course and DME.
- weather radar and TCAS are not displayed in center APP mode.

VOR –

- displays VOR navigation information in heading–up format
- displays reference VOR receiver, VOR frequency or identification, course, DME and TO/FROM information
- weather radar and TCAS are not displayed in center VOR mode.

MAP –

- displays FMC generated route and MAP information, airplane position, heading and track, in a track-up format
- displays waypoints, including the active waypoint, within the selected range
- displays VNAV path deviation.

PLN –

- displays a non-moving, true north up, route depiction
- the airplane symbol represents actual airplane position and orientation
- allows route step-through using the CDU LEGS page
- weather radar and TCAS are not displayed.

3 Center (CTR) Switch (inner)

PUSH –

- displays the full compass rose (center) for APP, VOR and MAP modes
- subsequent pushes alternate between expanded and center displays.

4 Range Selector (outer)

Selects desired display range in nautical miles for APP, VOR, MAP or PLN mode.

5 Traffic (TFC) Switch (inner)

PUSH – displays TCAS information on the navigation display (refer to Chapter 15, Warning Systems).

6 MAP Switches (momentary action)

The MAP switches:

- add background data/symbols to MAP and center MAP modes
- displays can be selected simultaneously
- second push removes the information.

WXR (weather radar) – energizes weather radar transmitter and displays weather radar returns in MAP, center MAP, expanded VOR and expanded APP modes. When the 640 nm range is selected, weather radar returns are limited to 320 nm (refer to Chapter 11, Flight Management, Navigation).

STA (station) –

- displays all FMC data base navigation aids if on map scales 5, 10, 20 or 40 nm
- displays FMC data base high altitude navigation aids on map scales 80, 160, 320 or 640 nm.

737 Flight Crew Operations Manual

WPT (waypoint) – displays the waypoints in the FMC data base which are not in the flight plan route if the selected range is 40 nm or less.

ARPT (airport) – displays all airports which are stored in the FMC data base and which are within the viewable map area.

DATA – displays altitude constraint, if applicable, and estimated time of arrival for each active route waypoint.

POS (position) – displays IRS positions, GPS positions and VOR bearing vectors extended from the nose of the airplane symbol to the stations.

TERR (terrain) – displays GPWS generated terrain data in MAP, center MAP, VOR, and APP modes (refer to Chapter 15, Warning Systems).

Displays Source Panel

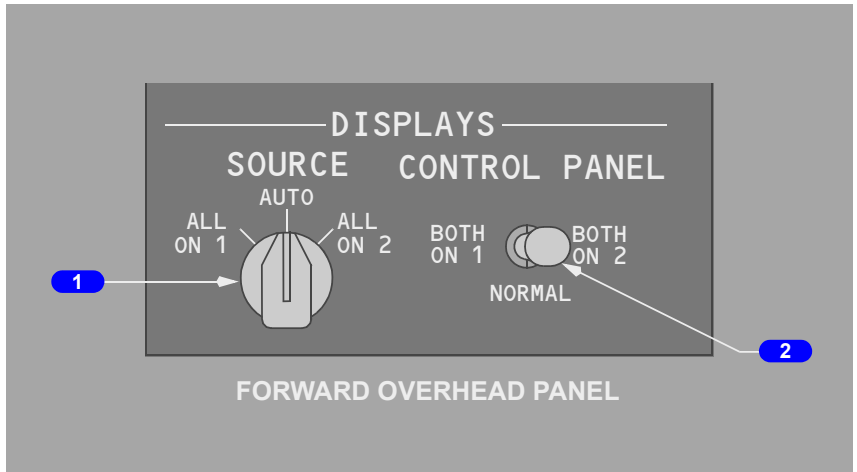

1 DISPLAYS SOURCE Selector

AUTO – DEU 1 controls the Captain outboard, Captain inboard, and the upper display units; DEU 2 controls the First Officer outboard, First Officer inboard, and the lower display units. When a DEU fails, the other DEU controls all display units.

ALL ON 1/ALL ON 2 – provides a means of manually switching to a single DEU as the source of information for all six display units.

Note: Used on the ground for maintenance purposes.

2 CONTROL PANEL Select Switch

NORMAL – the left EFIS control panel controls the Captain’s displays and the right EFIS control panel controls the First Officer’s displays.

BOTH ON 1/BOTH ON 2 – provides a means of manually switching control of the Captain's and First Officer's displays to a single EFIS control panel.

Display Select Panels

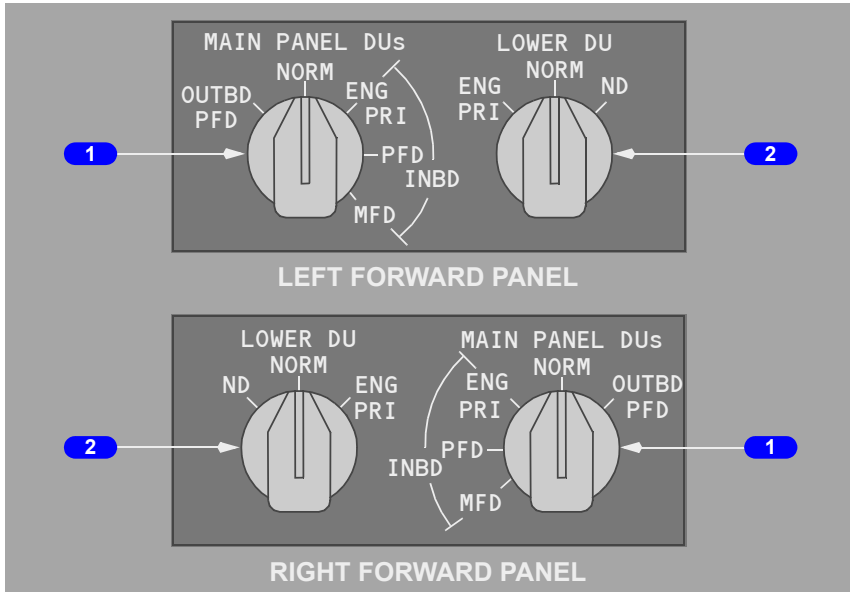

1 Main Panel Display Units (MAIN PANEL DUs) Selector

Selects what is displayed on the respective outboard and inboard display units:

- Outboard Primary Flight Display (OUTBD PFD) – displays the PFD on the outboard display unit and blanks the inboard display unit
- Normal (NORM) – displays PFD on the outboard display unit and ND on the inboard display unit
- Inboard Engine Primary (INBD ENG PRI) – displays the primary engine instruments on the inboard display unit and the PFD on the outboard display unit
- Inboard Primary Flight Display (INBD PFD) – displays the PFD on the inboard display unit and blanks the outboard display unit
- Inboard Multifunction Display (INBD MFD) – displays PFD on the outboard display unit and blanks the inboard display unit. The inboard display unit stays blank until system format (SYS) or secondary engine format (ENG) is selected with MFD switches on the engine display control panel.

2 Lower Display Unit (LOWER DU) Selector

Selects what is displayed on the lower display unit:

- Engine Primary (ENG PRI) – displays the primary engine instruments on the lower display unit and blanks the upper display unit
- Normal (NORM) – display unit is normally blank or displays MFD format selected on the engine display control panel
- Navigation Display (ND) – displays the navigation display on the lower unit.

Speed Reference Selector

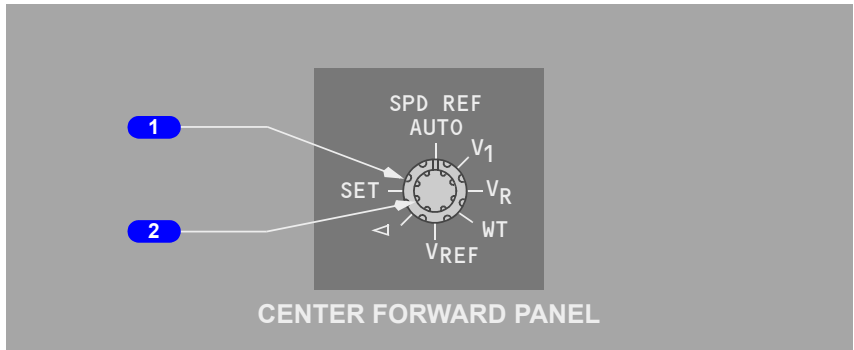

1 Speed Reference Selector (outer)

Sets the reference airspeed bugs on the airspeed indication:

- AUTO – the reference airspeeds and gross weight are provided automatically through the FMC
- V1 – used to manually set decision speed on the ground; in flight, displays “INVALID ENTRY”
- VR – used to manually set rotation speed on the ground; in flight, displays “INVALID ENTRY”
- WT – allows manual entry of reference gross weight
- VREF – used to manually set the landing reference speed in flight; on the ground, displays “INVALID ENTRY”
- Bug 5 – used to manually set the white bug 5 to the desired value
- SET – removes the speed reference display.

2 Speed Reference Selector (inner) (two speed slew)

ROTATE –

- manually sets the appropriate reference airspeed or gross weight
- the digital display appears below the airspeed indication.

Display Brightness Controls

Captain Brightness Controls

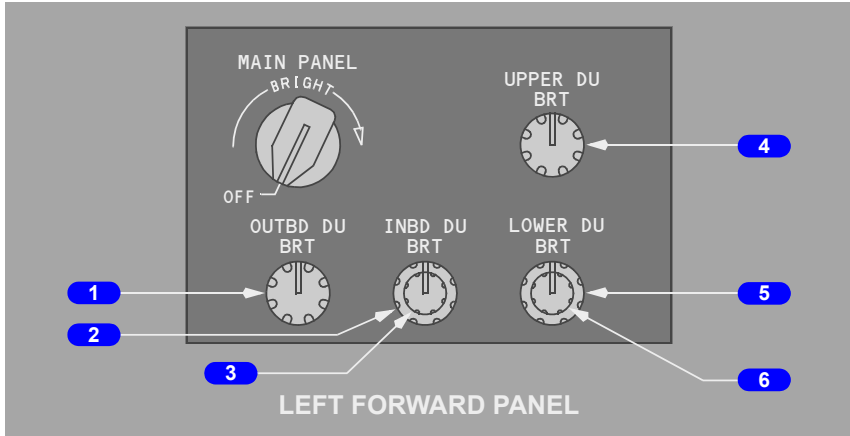

1 Outboard Display Unit Brightness (OUTBD DU BRT) Control (rotary)

ROTATE – adjusts the brightness of the Captain outboard display unit.

2 Inboard Display Unit Brightness (INBD DU BRT) Control (outer) (rotary)

ROTATE – adjusts the brightness of the Captain inboard display unit.

3 Inboard Display Unit Radar Brightness (INBD DU BRT) Control (inner) (rotary)

ROTATE – adjusts weather radar and terrain display brightness on the Captain inboard display unit.

4 Upper Display Unit Brightness (UPPER DU BRT) Control (rotary)

ROTATE – adjusts the brightness of the upper display unit.

5 Lower Display Unit Brightness (LOWER DU BRT) Control (outer) (rotary)

ROTATE – adjusts the brightness of the lower display unit.

6 Lower Display Unit Brightness (LOWER DU BRT) Control (inner) (rotary)

ROTATE – adjusts weather radar and terrain display brightness on the lower display unit.

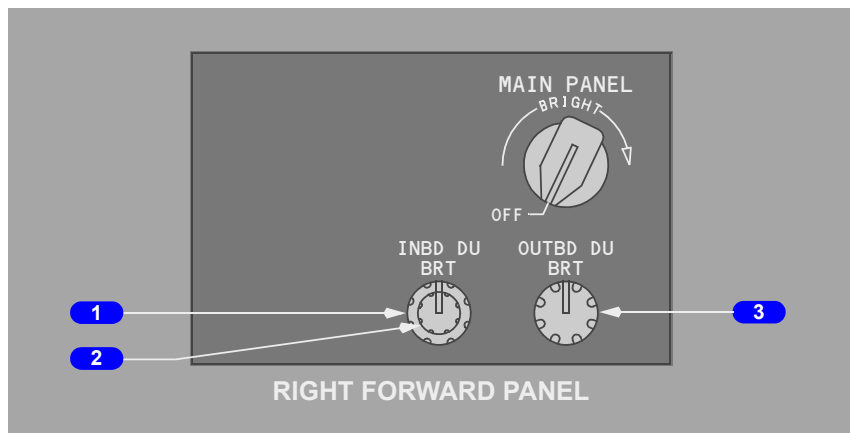
First Officer Brightness Controls

1 Inboard Display Unit Brightness (INBD DU BRT) Control (outer) (rotary)

ROTATE – adjusts the brightness of the First Officer inboard display unit.

2 Inboard Display Unit Radar Brightness (INBD DU BRT) Control (inner) (rotary)

ROTATE – adjusts weather radar and terrain display brightness on the First Officer inboard display unit.

3 Outboard Display Unit Brightness (OUTBD DU BRT) Control (rotary)

ROTATE – adjusts the brightness of the First Officer outboard display unit.

Standby Flight Instruments

The standby flight instruments include the:

- standby magnetic compass
YA373, YC202, YE324, YE325
- standby attitude indicator
YA374 - YA377, YC203 - YE323, YE326
- integrated standby flight display
- standby radio magnetic indicator.

Standby Magnetic Compass

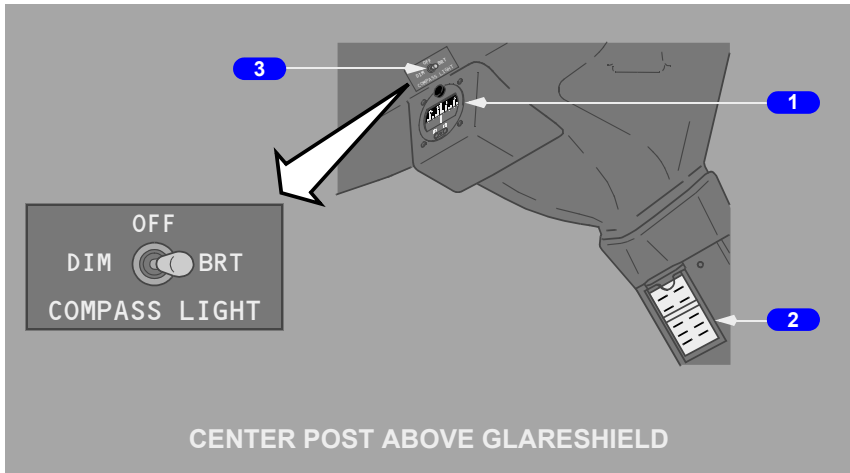

1 Standby Magnetic Compass

Displays magnetic heading.

2 Standby Magnetic Compass Correction Card

Provides appropriate heading corrections.

3 Compass Light Switch

OFF – compass light is extinguished.

BRT – sets compass light to full brightness.

DIM – sets compass light to low brightness.

Standby Attitude Indicator

YA373, YC202, YE324, YE325

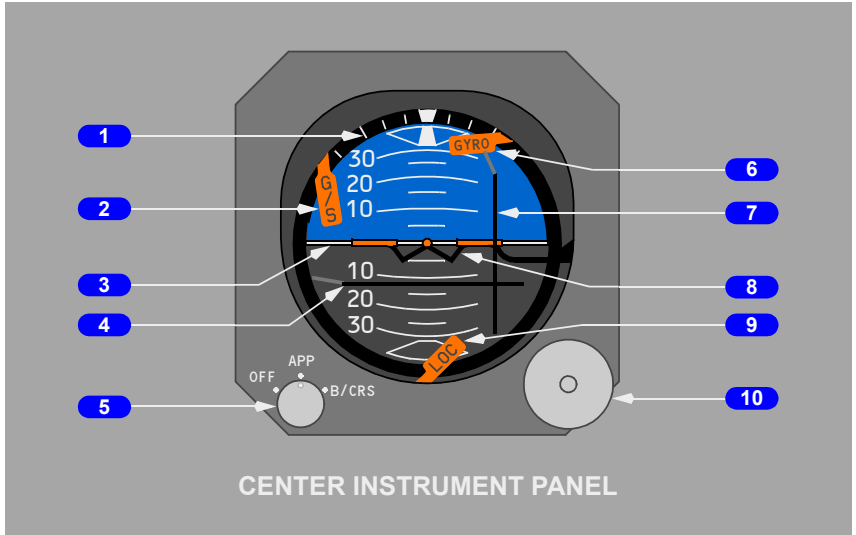

1 Bank Indicator and Scale

Scale marks are at 0, 10, 20, 30, 45 and 60 degrees.

2 Glide Slope Flag

- glide slope receiver has failed
- glide slope pointer is removed.

3 Horizon Line and Pitch Angle Scale

Pitch scale is in 5 degree increments.

4 Glide Slope Pointer and Deviation Scale

- pointer indicates glide slope position
- pointer is not displayed when
 - approach selector is off or in B/CRS
 - no computed data exists
 - glide slope receiver has failed
- scale indicates deviation.

5 Approach Mode Selector

OFF – glide slope and localizer pointers retracted from view.

APP – glide slope and localizer pointers in view; ILS signals provided by the No. 1 ILS receiver.

B/CRS – reverses sensing for localizer pointer during back course approaches; glide slope pointer not displayed.

6 GYRO Flag

Attitude is unreliable.

7 Localizer Pointer and Deviation Scale

- pointer indicates localizer position
- pointer is not displayed when
 - approach selector is off
 - no computed data exists
 - localizer receiver has failed
- scale indicates deviation.

8 Airplane Symbol

9 Localizer Flag

- localizer receiver has failed
- localizer pointer is removed.

10 Caging Control

PULL – aligns horizon line with the airplane symbol

RELEASE – the control contracts.

Standby Altimeter/Airspeed Indicator

YA373, YC202, YE324, YE325

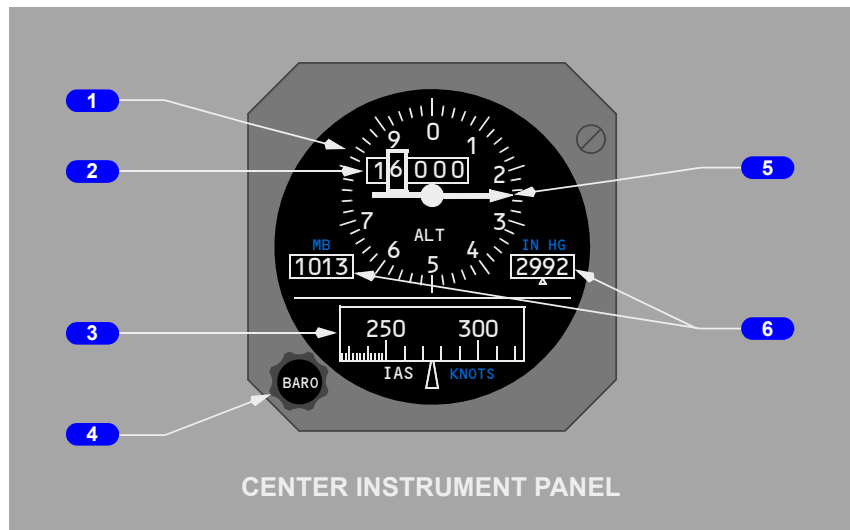

1 Standby Altimeter

Receives static pressure from the alternate static ports.

2 Digital Counter

- indicates thousand foot increments of current altitude
- a green flag appears in the left side of the window when altitude is less than 10,000 feet
- a striped flag appears in the left side of the window when altitude is less than zero feet.

3 Standby Airspeed Indicator

Receives ram air pressure from the auxiliary pitot probe and static pressure from the alternate static ports.

4 Barometric Setting Control

ROTATE – adjusts the barometric correction in both barometric windows.

5 Altitude Pointer

Indicates hundred foot increments of current altitude.

6 Barometric Setting Windows

Indicates barometric correction in millibars and inches of mercury as set by the barometric setting control.

Integrated Standby Flight Display

YA374 - YA377, YC203 - YE323, YE326

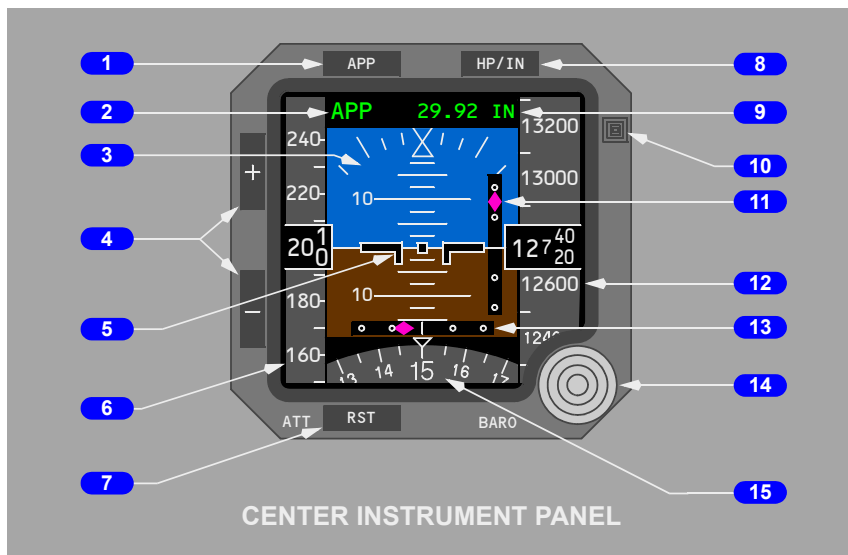

1 Approach (APP) Switch

Push -

- when blank, selects APP
- when APP displayed, selects BCRS
- when BCRS displayed, blanks

2 Approach Mode Annunciation

Indicates approach mode selected.

- Blank - no approach deviation data displayed
- APP - ILS localizer and glideslope deviation data displayed
- BCRS (Back course) - reverses sensing for localizer pointer during back course approaches

3 Attitude Display

Displays airplane attitude.

- Indicates bank in reference to the bank scale
- Indicates the horizon relative to the airplane symbol
- Beyond 30 degrees pitch, large red arrowheads (V-shaped) indicate the attitude has become excessive, and the direction to the horizon line.

4 Display Brightness Switches

Push –

- + increases display brightness
- - decreases display brightness

5 Airplane Symbol

Indicates airplane attitude with reference to the horizon.

6 Airspeed Indications

Indicates current airspeed when above 30 knots.

7 Attitude Reset (RST) Switch

Push and hold at least two seconds

- aligns horizon with the airplane symbol
- reset takes approximately ten seconds
- starts new initialization sequence if previous attempt failed (ground only)

8 Hectopascal/Inch (HP/IN) Switch

Push – changes the units of the barometric reference.

9 Barometric Setting

Indicates the barometric setting selected with the barometric selector.

STD is displayed when selected with the barometric selector.

10 Ambient Light Sensor

Automatically adjusts display intensity for ambient lighting condition.

11 Glideslope Pointer and Deviation Scale

The glideslope pointer indicates glideslope position relative to the airplane.

- the pointer is in view when the glideslope signal is received
- the scale is in view when the APP mode is selected
- the pointer and scale are removed when the BCRS mode is selected

12 Current Altitude

13 Localizer Pointer and Deviation Scale

The localizer pointer indicates localizer position relative to the airplane.

- the pointer is in view when the localizer signal is received
- the scale is in view when either the APP or BCRS mode is selected

14 Barometric (BARO) Selector

Rotate – changes barometric setting

Push –

- selects standard barometric setting (29.92 inches Hg/1013 HPA)
- if STD is displayed, selects the preselected barometric setting

15 Heading Indication

Displays airplane heading.

ISFD Messages

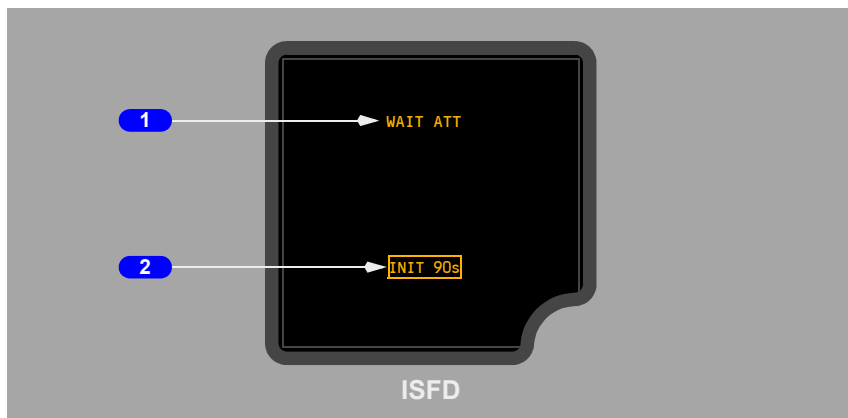

1 Attitude Messages

Indicates attitude display status.

- ATT:RST (amber) – attitude must be reset using the attitude reset switch
- ATT 10s (amber) – 10 second attitude realignment in progress
- WAIT ATT (amber) – indicates temporary self correcting loss of attitude

2 Initialization Message

INIT 90s (amber) – 90 second initialization countdown.

- countdown stops if excessive motion is detected
- countdown resumes when motion stops
- ATT:RST displays if initialization is not complete within six minutes

ISFD Failure Flags

The OUT OF ORDER annunciation replaces the display when a total ISFD system failure occurs.

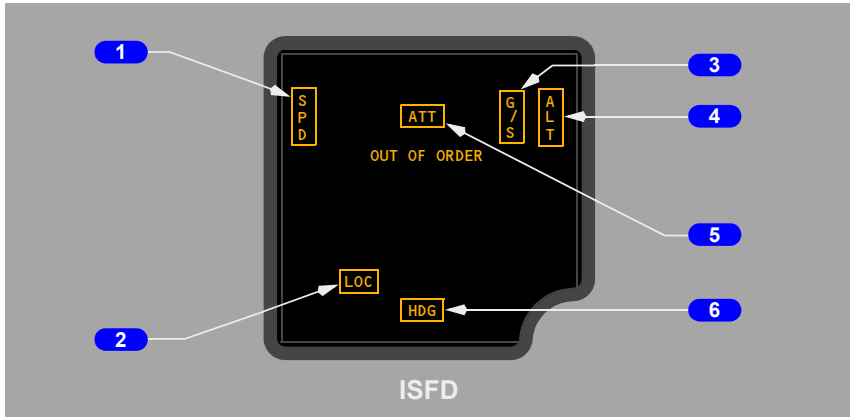

1 Airspeed flag

Airspeed information has failed.

2 ILS localizer failure flag

ILS localizer has failed.

3 ILS glideslope failure flag

ILS glideslope has failed.

4 Altitude flag

Altitude information has failed.

5 Attitude flag

Attitude information has failed.

6 Heading flag

Heading data has failed.

Standby Radio Magnetic Indicator

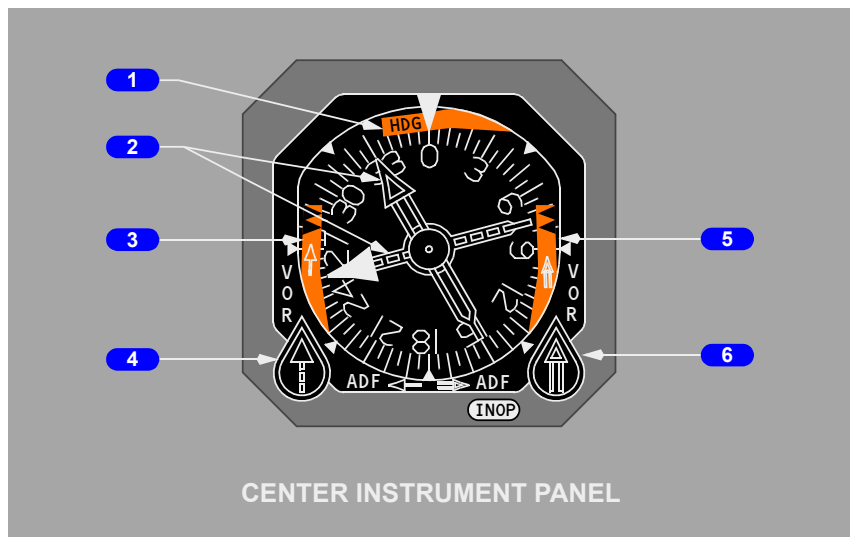

1 Heading Warning Flag

The compass signal from the air data inertial reference system is lost.

2 Bearing Pointers

- narrow pointer uses signals from the VHF NAV receiver No. 1 or ADF receiver No. 1
- wide pointer uses signals from the VHF NAV receiver No. 2.

3 Bearing Pointer No. 1 Warning Flag

VOR mode:

- RMI power failure
- VHF NAV signal unreliable.

ADF mode:

- RMI power failure
- ADF failure or signal unreliable.

4 VOR/ADF Bearing Pointer No. 1 Switch

ROTATE – selects VOR or ADF for the bearing pointer.

5 Bearing Pointer No. 2 Warning Flag

VOR mode:

- RMI power failure
- VHF NAV signal unreliable.

6 VOR Bearing Pointer No. 2 Switch

ROTATE – selects VOR for the bearing pointer.

Clock

YA373 - YA376, YC202 - YC206, YE321 - YE326

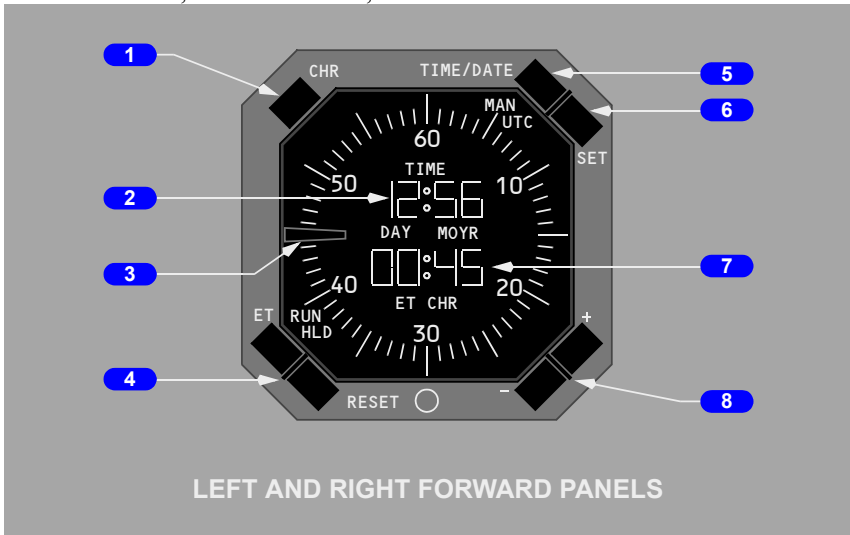

YA377, YC207

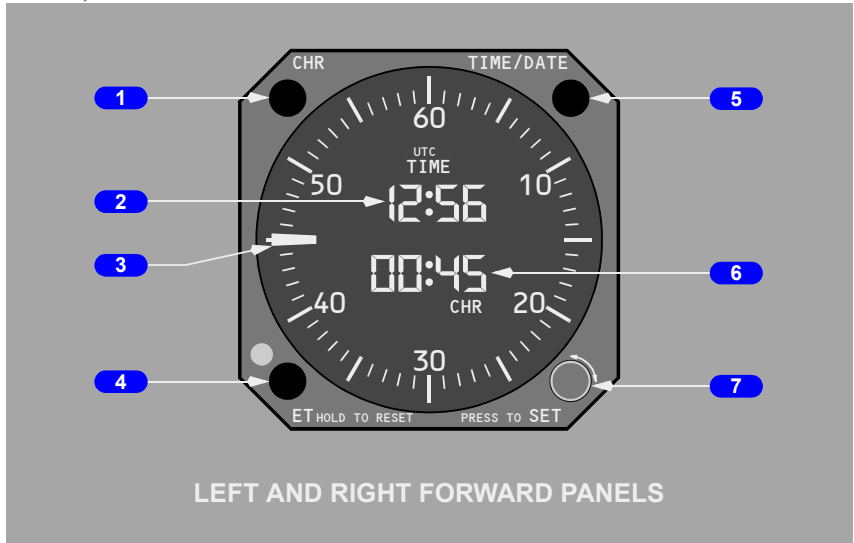

1 Chronograph (CHR) Control

PUSH –

- controls the start, stop and reset functions of the CHR display and second hand with successive pushing
- overrides any existing ET display.

2 Time/Date Indicator

- displays UTC or manual time (hours, minutes) when time is selected with the time/date pushbutton
- alternately displays day–month and year when date is selected with the time/date pushbutton.

3 Chronograph Second Hand

- indicates chronograph seconds
- controlled by the CHR control.

4 Elapsed Time (ET) and RESET Pushbutton

YA373 - YA376, YC202 - YC206, YE321 - YE326

Controls the elapsed time function:

- select the ET pushbutton once to run the elapsed time
- select the ET pushbutton again to hold the elapsed time
- select the RESET pushbutton to set the elapsed time to 0.

The RUN or HLD symbol is displayed on the lower left part of the LCD display.

4 Elapsed Time (ET) Pushbutton

YA377, YC207

Controls the elapsed time function:

- select the ET pushbutton once to run the elapsed time.
- select the ET pushbutton again to hold the elapsed time.
- select the ET pushbutton again to continue the elapsed time.
- select the ET pushbutton for 2 seconds to set the elapsed time to 0 and clear the display.

The ET and RUN or HLD symbols are displayed below the elapsed time.

5 TIME/DATE Pushbutton

Controls the time/date function:

- select the TIME/DATE pushbutton once to see UTC time
- select the TIME/DATE pushbutton again to see UTC date
- select the TIME/DATE pushbutton again to see manual time
- select the TIME/DATE pushbutton again to see manual date.

The UTC or MAN symbol is displayed on the upper right part of the LCD display.

In MAN mode, clock time and date come from the clock. In UTC mode, clock time and date come from the global positioning system.

6 SET Pushbutton

YA373 - YA376, YC202 - YC206, YE321 - YE326

Controls the setting of manual time and date:

With manual time displayed:

- select the SET pushbutton once and the hours flash, use the plus or minus pushbutton to adjust the hours
- select the SET pushbutton again and the minutes flash, use the plus or minus pushbutton to adjust the minutes
- select the SET pushbutton again to run the time.

With manual date displayed:

- select the SET pushbutton once and the day flashes, use the plus or minus pushbutton to adjust the day
- select the SET pushbutton again and the month flashes, use the plus or minus pushbutton to adjust the month

- select the SET pushbutton again and the year flashes, use the plus or minus pushbutton to adjust the year
- select the SET pushbutton again to run the date.

Note: A delay greater than one minute while setting the time or date results in the clock reverting to the previous time/date setting.

6 Elapsed Time (ET)/Chronograph Indicator

YA377, YC207

- displays elapsed time (hours, minutes) or chronograph minutes
- the chronograph display replaces the elapsed time display
- elapsed time continues to run in the background and displays after the chronograph is reset.

7 Elapsed Time (ET)/Chronograph Indicator

YA373 - YA376, YC202 - YC206, YE321 - YE326

- displays elapsed time (hours, minutes) or chronograph minutes
- the chronograph display replaces the elapsed time display
- elapsed time continues to run in the background and displays after the chronograph is reset.

7 SET Control

YA377, YC207

Controls the setting of manual time and date:

With manual time displayed:

- select the SET control once and the hours flash, rotate the control to adjust the hours
- select the SET control again and the minutes flash, rotate the control to adjust the minutes
- select the SET control again to run the time.

With manual date displayed:

- select the SET control once and the day flashes, rotate the control to adjust the day
- select the SET control again and the month flashes, rotate the control to adjust the month
- select the SET control again and the year flashes, rotate the control to adjust the year
- select the SET control again to run the date.

Note: A delay greater than one minute while setting the time or date results in the clock reverting to the previous time/date setting.

8 Plus (+) and Minus (-) Pushbuttons

YA373 - YA376, YC202 - YC206, YE321 - YE326

Used to set the manual time and date:

- select the + pushbutton to increase the value
- select the - pushbutton to decrease the value.

Flight Recorder

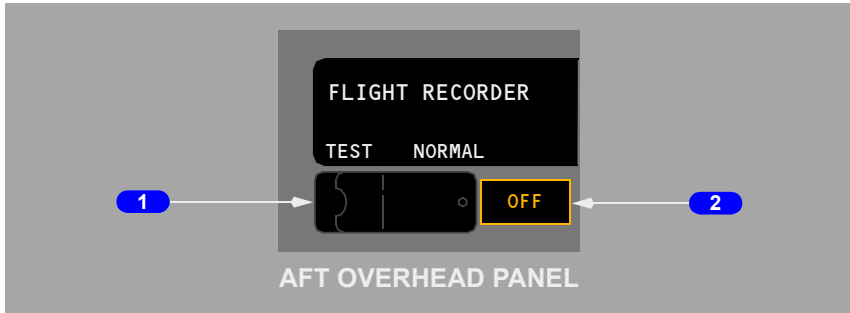

1 Flight Recorder Test Switch

NORMAL (guarded position) -

- in flight - the recorder operates anytime electrical power is available
- on the ground - either engine must also be operating.

TEST - powers the flight recorder on the ground.

2 OFF Light (amber)

ILLUMINATED -

- indicates the recorder is not operating or the test is invalid
- may indicate power failure, loss of input data, or electronic malfunction.



This Section Applies to YA371, YA372, YC201

Introduction

The common display system (CDS) supplies information to the flight crew on six flat panel liquid crystal display units (DUs). The outboard and inboard display units present all primary flight and navigation information. Engine and system data are normally shown on the upper display unit. The lower display unit serves as a spare.

Detailed information on the following subjects is found in other sections of this chapter:

- Electronic Flight Instrument System (EFIS) – Section 30
- Navigation display – Section 40.

Display Brightness Control

Adjustment of the brightness of each DU is controlled by a combination of light sensors and brightness controls. Two remote light sensors, located left and right on the top of the glareshield, compensate for the amount of ambient light entering through the flight deck windows and adjust the brightness of the related DUs. Each DU also has an integral light sensor which provides automatic control of brightness as a function of ambient light striking the face of the DU. Brightness controls are used by the pilot to further adjust the intensity of each display unit.

DISPLAYS SOURCE Panel

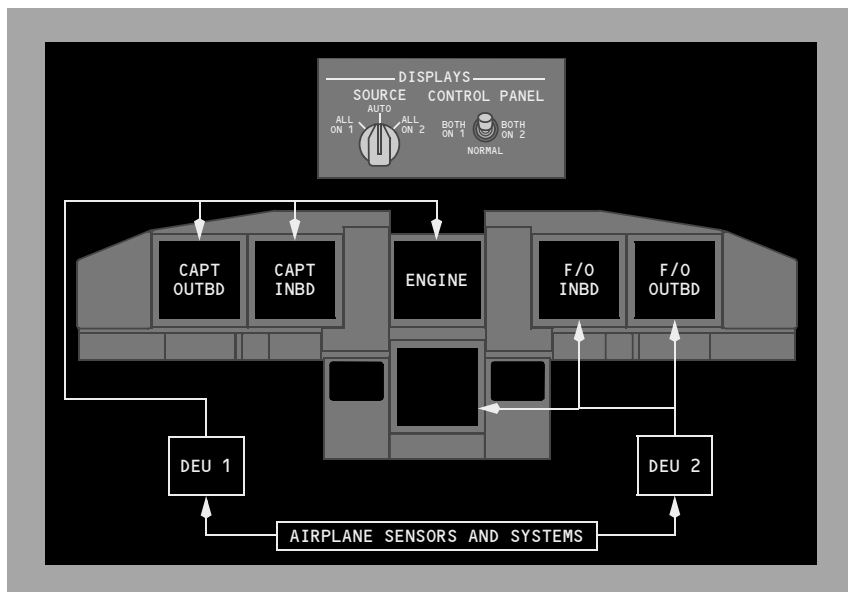

The DISPLAYS source panel, located on the forward overhead panel, contains source controls for the display electronic units (DEUs) and EFIS control panels.

Two DEUs receive data from sensors and airplane systems and supply data to the DUs. During normal operation, with the display SOURCE selector in the AUTO position, DEU1 supplies data to the Captain outboard, Captain inboard and upper DUs while DEU2 supplies data to the First Officer outboard, First Officer inboard and lower DUs. If a DEU fails, the remaining DEU automatically supplies data to all six displays. A single DEU failure will continue to supply each pilot with flight instrument information from independent sources. Each DEU receives data from both ADIRUs.

The display SOURCE selector, used on the ground for maintenance purposes, allows manual selection of either DEU1 or DEU2 for all six display units. If the displays are automatically or manually switched to a single DEU source, a “DSPLY SOURCE” annunciation illuminates above both pilot’s altimeters.

The CONTROL PANEL select switch determines which EFIS control panel controls the pilots’ display functions. With the switch positioned to either BOTH ON 1 or BOTH ON 2, the selected EFIS control panel provides inputs for both sets of pilot displays. When in the NORMAL position, a “DISPLAYS CONTROL PANEL” annunciation illuminates on the pilot’s altimeters and indicates a failure of the associated EFIS control panel.

EFIS Control Panels

The EFIS control panels, located on the glareshield, control display options, mode, and range for the related pilot's displays. Refer to the EFIS and navigation display sections of this chapter for detailed information.

If an EFIS control panel fails, the displays can be controlled by the remaining control panel.

Display Select Panel

The display select panel, located on the left and right forward panels, controls the displays on the inboard, outboard and lower DUs. Normal operation is all selectors in the NORMAL position. The pilots' outboard and inboard DUs display primary flight and navigation data and the upper DU displays engine data.

If a DU fails, automatic display switching ensures critical information remains available to the pilots at all times. If the system detects an operational failure on an outboard DU, the compact EFIS format automatically moves to the inboard DU and the failed outboard DU blanks. If the system detects a failure on an inboard DU, the compact EFIS format automatically moves to the outboard DU and the failed inboard DU blanks. If the upper DU fails, the engine display automatically moves to the lower DU.

Manual control of display formats is provided for undetected failures. The outboard rotary switch on the display select panel controls the formats displayed on either the outboard or inboard DUs. The inboard rotary switch controls the display format shown on the lower DU.

Display Selection and Control Examples

The following examples show display selections.

Normal Display Configuration

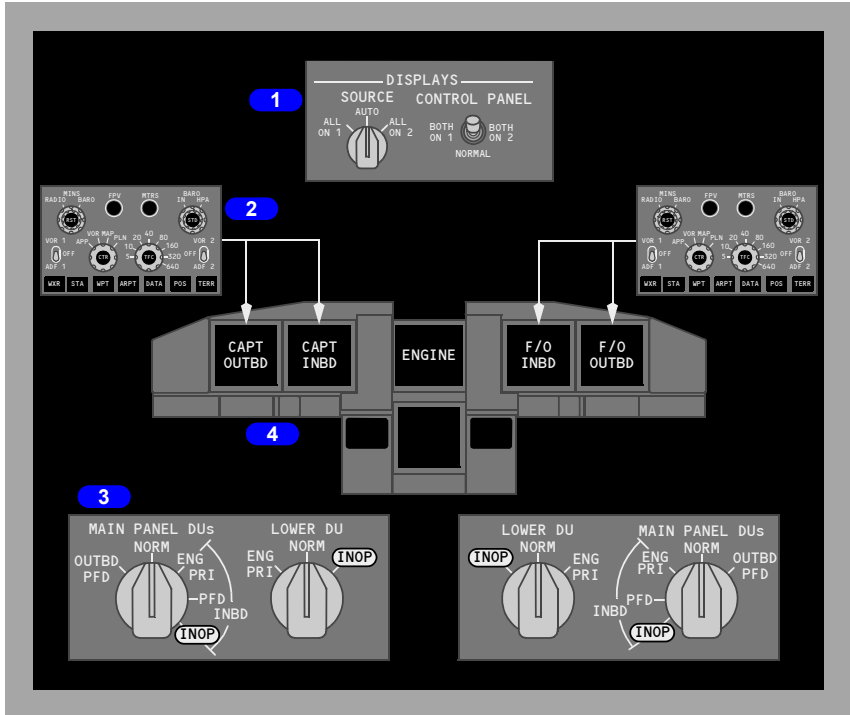

1 DISPLAYS Source Panel

The display SOURCE select switch is in AUTO and the CONTROL PANEL select switch is in NORMAL.

2 EFIS Control Panel

The left EFIS control panel controls the Captain outboard and inboard display units. The right EFIS control panel controls the First Officer outboard and inboard display units.

3 Display Select Panel

All selectors are in NORMAL.

4 Display Units

The pilots' outboard and inboard DUs show the normal EFIS/MAP displays.

Display Unit Failure Automatic Switching

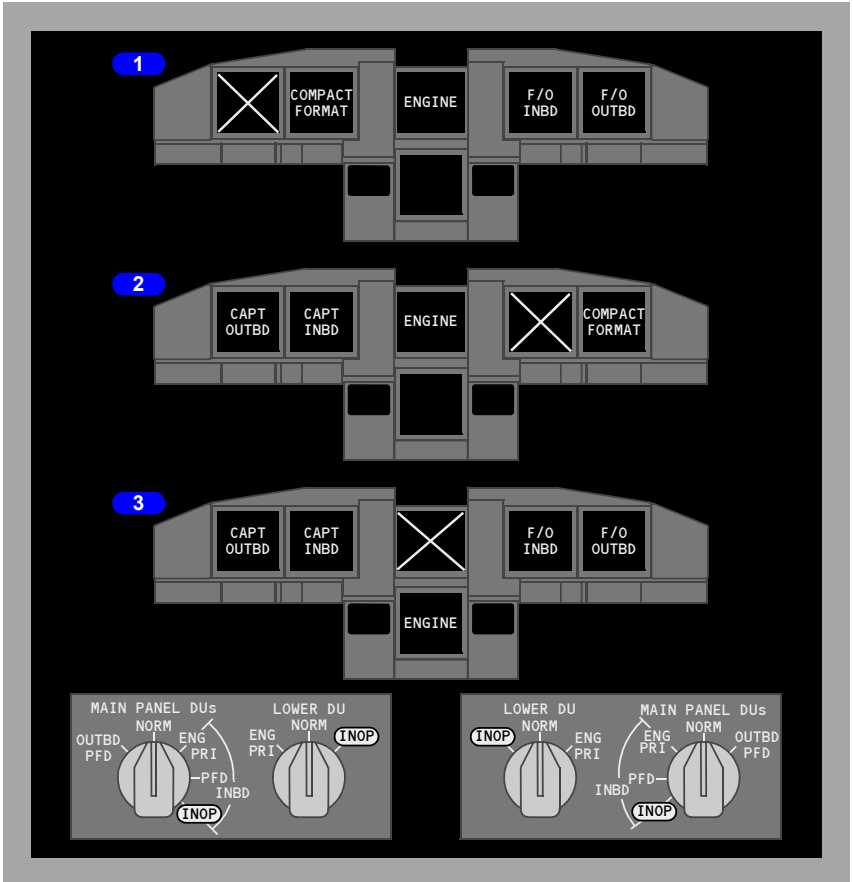

1 Outboard Display Unit Fails

If an outboard display unit fails, the compact EFIS format is automatically displayed on the inboard display unit and the outboard display unit blanks.

2 Inboard Display Unit Fails

If an inboard display unit fails, the compact EFIS format is automatically displayed on the outboard display unit and the inboard display unit blanks.

3 Upper Display Unit Fails

If the upper display unit fails, the engine display automatically moves to the lower display unit and the upper display unit blanks.

Note: There is no automatic switching for a lower DU failure.

EFIS Control Panel

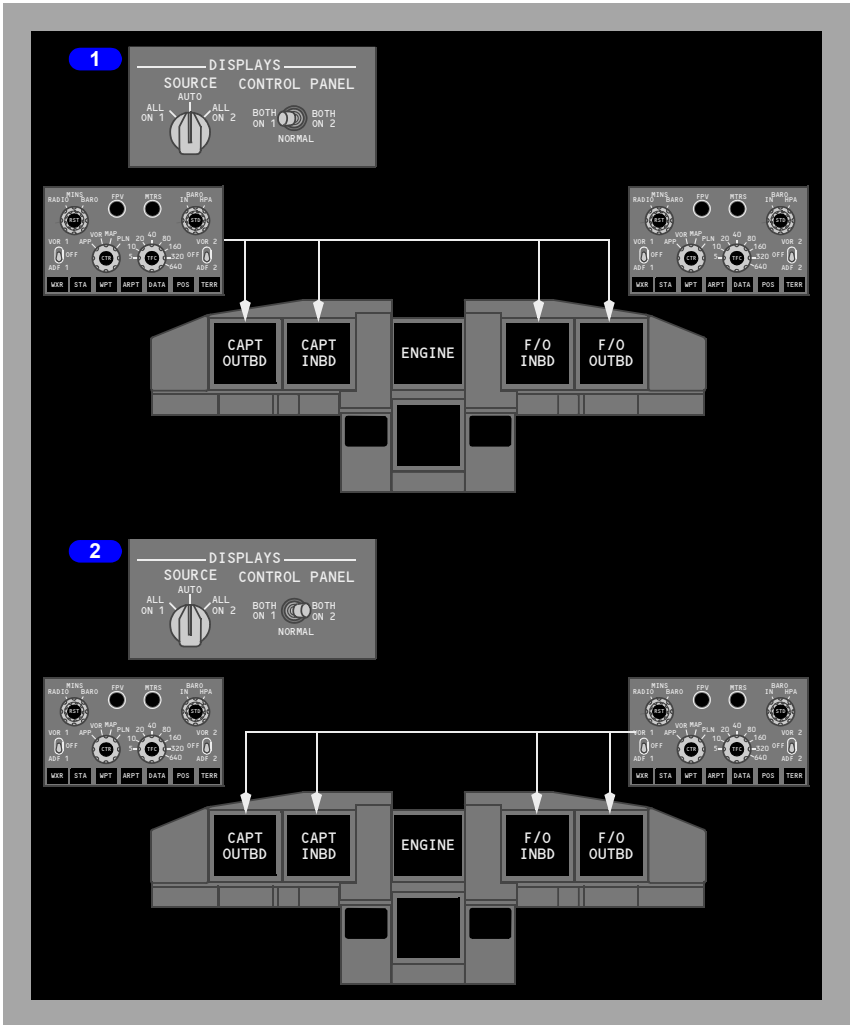

1 CONTROL PANEL Select Switch BOTH ON 1

The left EFIS control panel controls both pilots' outboard and inboard display units.

2 CONTROL PANEL Select Switch BOTH ON 2

The right EFIS control panel controls both pilots' outboard and inboard display units.

Outboard Display Switching

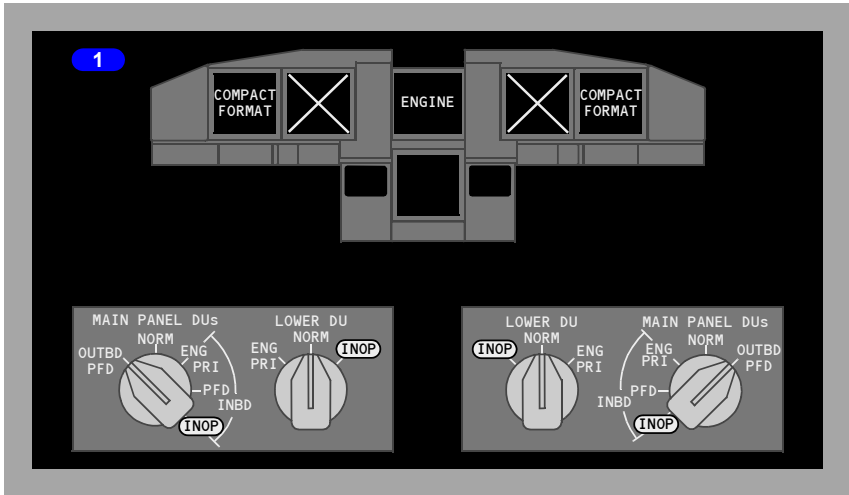

1 MAIN PANEL DUs Switch to OUTBD PFD

If the MAIN PANEL DUs switch is turned to Outboard Primary Flight Display (OUTBD PFD), the compact EFIS format is displayed on the outboard display unit and the inboard display unit blanks.

Inboard Display Switching

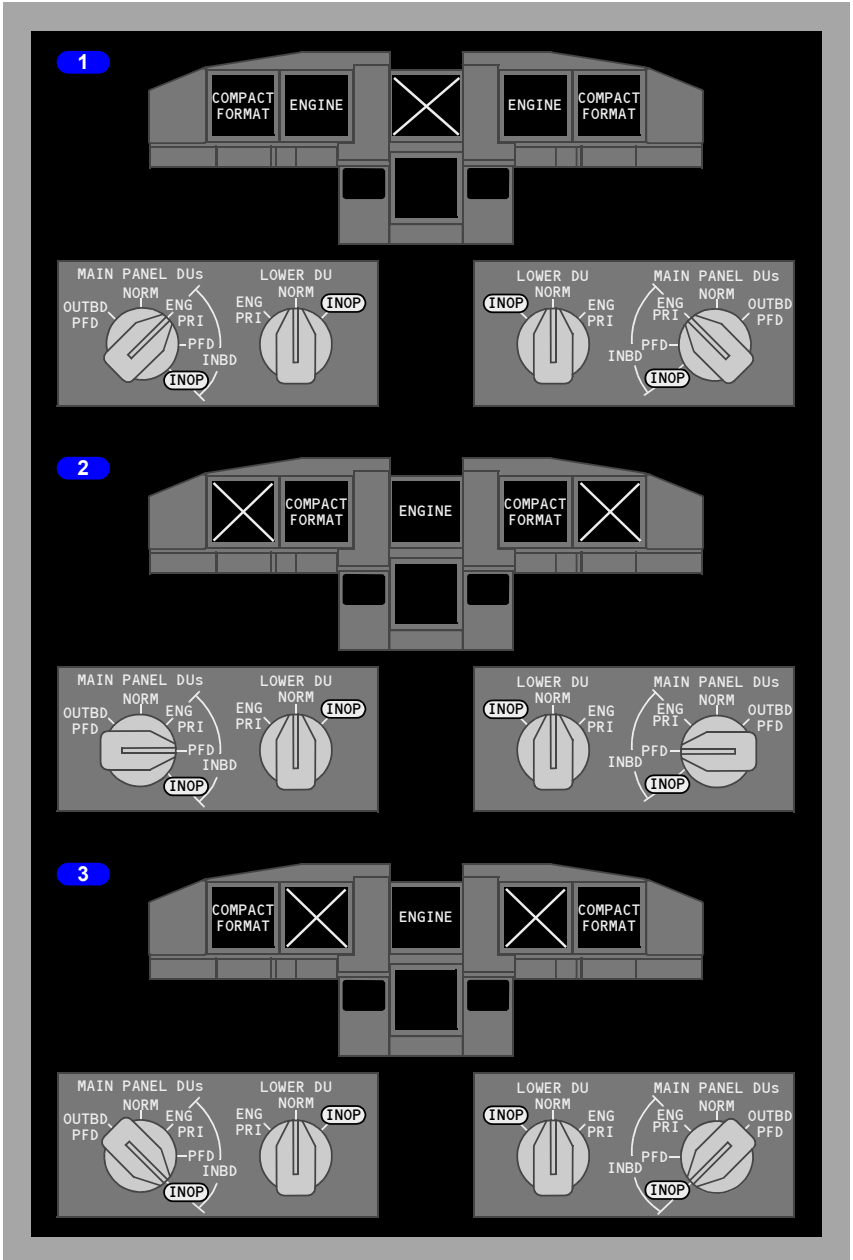

1 MAIN PANEL DUs Switch to INBD ENG PRI

If the MAIN PANEL DUs switch is turned to INBD ENG PRI, the engine display moves to the inboard DU, the compact EFIS format is displayed on the outboard DU and the upper DU blanks.

2 MAIN PANEL DUs Switch to INBD PFD

If the MAIN PANEL DUs switch is turned to INBD PFD the compact EFIS format is displayed on the inboard DU and the outboard DU blanks.

3 MAIN PANEL DUs Switch to INOP

If the MAIN PANEL DUs switch is turned to INBD INOP the compact EFIS format is displayed on the outboard DU and the inboard DU blanks.

Lower Display Switching

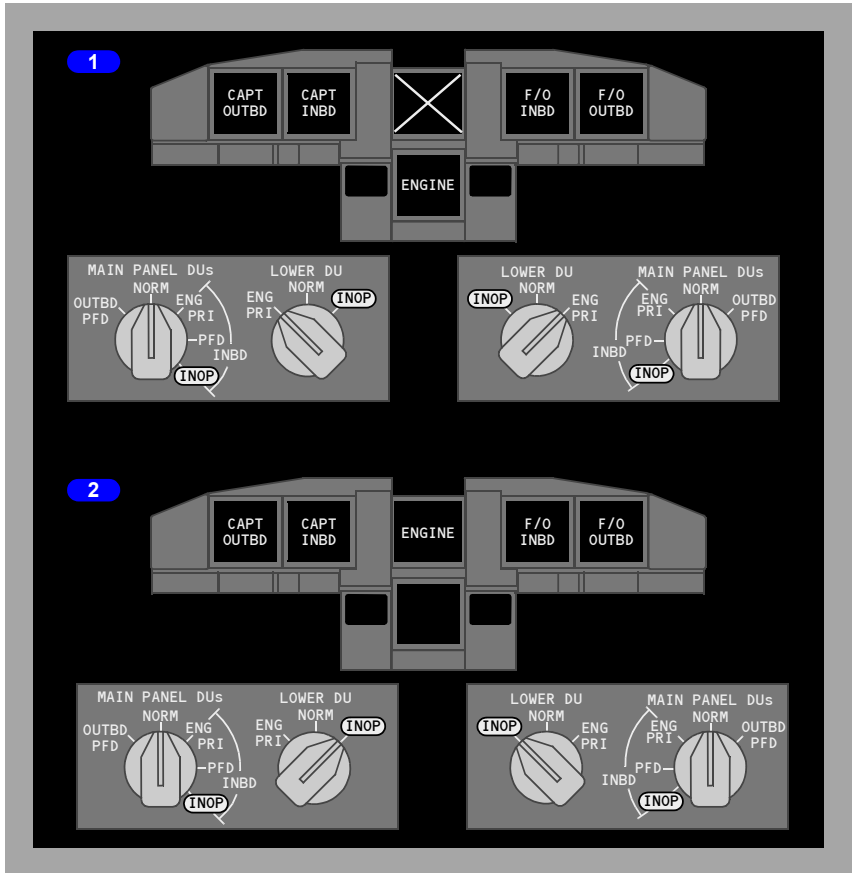

1 LOWER DU Switch to ENG PRI

If the LOWER DU switch is turned to ENG PRI, the engine display moves to the lower DU and the upper DU blanks.

2 LOWER DU Switch to INOP

If the LOWER DU switch is turned to INOP the engine display is shown on the upper DU and the lower DU blanks.

Display System Information Sources

Air Data Inertial Reference System (ADIRS)

The ADIRS produces flight data such as position, speed, altitude and attitude for the flight displays, flight management computers, flight controls, engine controls and all other systems requiring inertial and air data.

The major components of the ADIRS are:

- two air data inertial reference units (ADIRUs)
- four air data modules (ADMs)
- one inertial system display unit (ISDU)
- one dual mode select unit (MSU)
- six static ports
- three pitot probes
- two alpha vanes
- one total air temperature probe

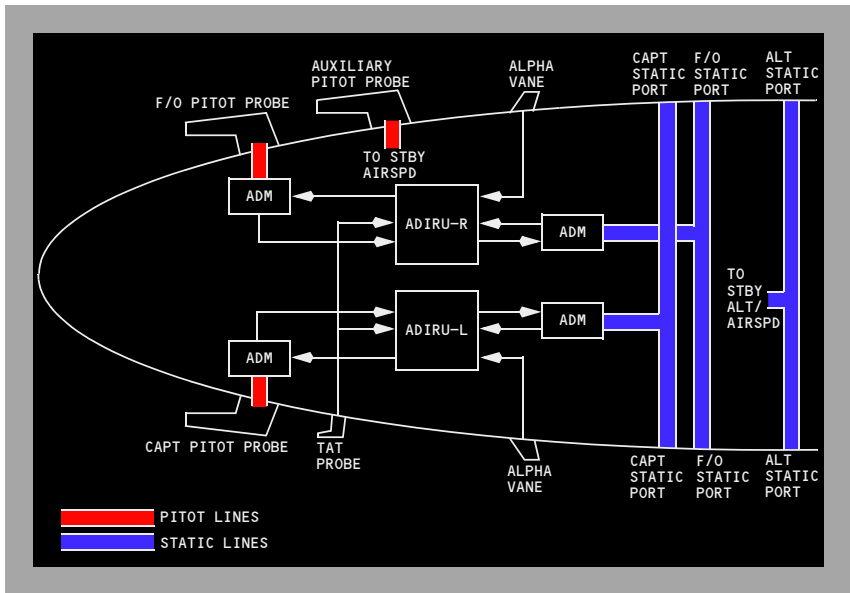

Air Data Inertial Reference Unit (ADIRU)

The ADIRUs provide inertial position and track data to the FMC as well as attitude, altitude and airspeed data to the displays. The ADIRUs process information measured by internal gyros and accelerometers, and from air data module inputs, the alpha vanes and other systems.

The ADIRUs are described in Chapter 11, Flight Management, Navigation.

Air Data

The pitot static system is comprised of three separate pitot probes and six flush static ports. Two pitot probes and four static ports interface with the air data modules. The remaining auxiliary pitot probe and alternate static ports provide pitot and static pressure to the standby instruments. The auxiliary pitot probe is located on the first officer's side of the airplane.

The air data modules convert pneumatic pressure to electrical signals and send these data to the ADIRUs. Each pitot air data module is connected to its on-side pitot probe; there is no cross connection. The air data module connected to the Captain's pitot probe sends information to the left ADIRU, while the air data module connected to the First Officer's pitot probe sends information to the right ADIRU. The remaining air data modules are located at the balance centers of the Captain's and First Officer's static ports. The air data module connected to the Captain's static ports sends information to the left ADIRU, while the air data module connected to the First Officer's static ports sends information to the right ADIRU.

Angle-of-Attack

There are two alpha vanes, one located on each side of the forward fuselage. The vanes measure airplane angle-of-attack relative to the air mass.

Total Air Temperature

A total air temperature probe is mounted outside the airplane to sense air mass temperature. The temperature sensed by the probe is used by the ADIRUs to compute total air temperature.

Static Air Temperature

Static air temperature, displayed on the CDU PROGRESS page, comes from the ADIRUs, using total air temperature probe information.

Standby Flight Instruments

The standby flight instruments include:

- standby magnetic compass
- integrated standby flight display
- standby radio magnetic indicator

Standby Magnetic Compass

A standard liquid-damped magnetic standby compass is provided. A card located near the compass provides heading correction factors.

Integrated Standby Flight Display (ISFD)

The ISFD displays attitude, airspeed, altitude, ILS, and magnetic heading information. It is connected directly to the auxiliary pitot and alternate static sources. Attitude information is provided by internal inertial sensors. ILS information is provided by the No. 1 ILS receiver. The display receives its heading information from the same source as the captain's primary flight display. Heading information is not available in polar regions.

Note: The standby magnetic compass must be used to validate heading information.

The battery bus powers the ISFD. Selecting the battery switch ON activates the ISFD. After 10 seconds, an initialization sequence begins that requires 90 seconds to complete. ATT and INIT 90s messages are displayed during initialization. Upon completion of the initialization sequence, attitude information is displayed.

Note: Any change in airplane position during the initialization sequence may result in an inaccurate alignment. Inaccurate alignment is not annunciated and may result in the display of inaccurate attitude prior to, and during flight. Re-initialization can only be accomplished through maintenance action.

Detection of a momentary out-of-limit ISFD condition may cause the attitude display to blank and the WAIT ATT or ATT:RST message to display. Operation of the attitude reset switch is required in response to the ATT:RST message. This will reset the horizon line with the airplane symbol.

Note: Operation of the attitude reset switch will not correct an inaccurate alignment.

On the ground, operation of the attitude reset switch must be performed with the airplane stationary. In flight, operation of the attitude reset switch must be performed with the airplane in wings level, non-accelerated flight. During the process, the ATT 10s message displays. Failure to maintain straight and level flight for 10 seconds may result in an ATT:RST message. If the reset attempt is unsuccessful, the ATT:RST message remains displayed and the ISFD does not enter normal operation.

Standby Radio Magnetic Indicator

The standby radio magnetic indicator (RMI) displays magnetic heading and VOR/ADF bearing to the station. The RMI is powered by the AC standby bus and remains powered after the loss of all normal AC power as long as battery power is available.

Clocks

Two electronic clocks are installed, with two digital displays on each clock. Universal time coordinated (UTC) time, UTC date, manual time or manual date may be set on the upper time display. The lower ET/CHR display is used for either elapsed time or the chronograph. Separate controls are provided for each display.

Each clock is powered by the hot battery bus when the battery bus is not available. The clock reverts to hot battery bus power when the airplane is powered down. The hot battery bus power keeps the time base but does not provide power for the display or output of clock data and the clock reverts to manual mode. When the airplane is powered up and Global Position System (GPS) data is restored, the clock continues to operate in manual mode and will not automatically display UTC time. UTC time can be manually selected by using the TIME/DATE pushbutton.

Note: When on standby power, the F/O clock display is dim and UTC time is not available.

Flight Recorder

The flight recorder provides a permanent record of selected operational and systems information such as altitude, heading, acceleration, and airspeed. The recorder is housed in a sealed, fire-resistant container located behind an access door in the aft cabin ceiling.

Operational and systems information is automatically recorded whenever the flight recorder is powered. On the ground, the recorder begins operating when one of the engines is operating. In the air, the flight recorder is powered even with both engines shut down as long as APU electrical power is available.

Aircraft Condition Monitoring System (ACMS)

The ACMS consists of a digital flight data acquisition unit (DFDAU) and digital flight data recorder (DFDR).

The DFDAU receives signals representing certain flight condition and airplane systems' operating performance and converts them to a digital form for recording on the DFDR.

The DFDR records airplane systems and flight data for at least the last 25 hours of operation. The DFDR is located in the aft fuselage area.

Intentionally
Blank



This Section Applies to YA373 - YA377, YC202 - YE326

Introduction

The common display system (CDS) supplies information to the flight crew on six flat panel liquid crystal display units (DUs). The outboard and inboard display units present all primary flight and navigation information. Primary engine indications are normally displayed on the upper DU. Secondary engine indications or system data are normally displayed on the lower DU.

Detailed information on the following subjects is found in other sections of this chapter:

- Primary Flight Display (PFD)– Section 31
- Navigation display (ND)– Section 41.

Display Brightness Control

Adjustment of the brightness of each DU is controlled by a combination of light sensors and brightness controls. Two remote light sensors, located left and right on the top of the glareshield, compensate for the amount of ambient light entering through the flight deck windows and adjust the brightness of the related DUs. Each DU also has an integral light sensor which provides automatic control of brightness as a function of ambient light striking the face of the DU. Brightness controls are used by the pilot to further adjust the intensity of each display unit.

DISPLAYS SOURCE Panel

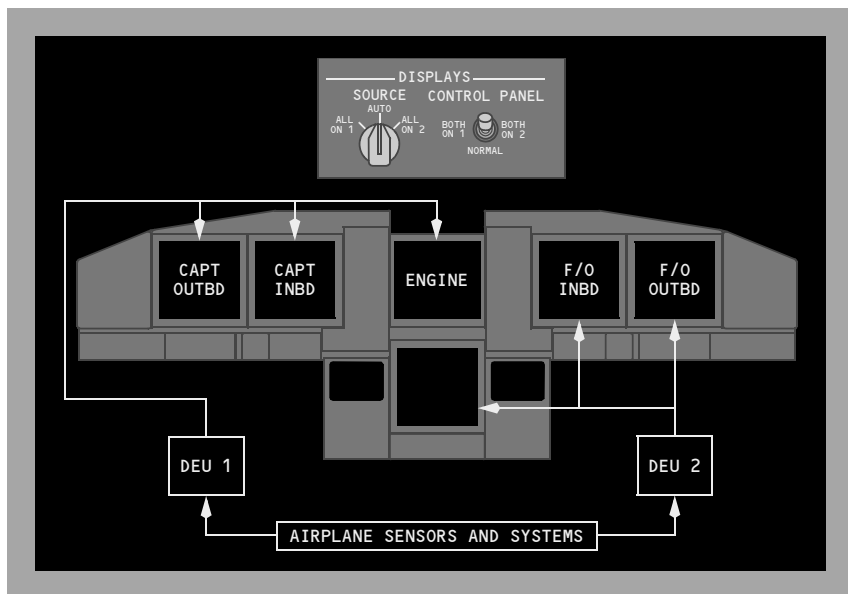

The DISPLAYS source panel, located on the forward overhead panel, contains source controls for the display electronic units (DEUs) and EFIS control panels.

Two DEUs receive data from sensors and airplane systems and supply data to the DUs. During normal operation, with the display SOURCE selector switch in the AUTO position, DEU1 supplies data to the Captain outboard, Captain inboard and upper DUs while DEU2 supplies data to the First Officer outboard, First Officer inboard and lower DUs. If a DEU fails, the remaining DEU automatically supplies data to all six displays. A single DEU failure will continue to supply each pilot with flight instrument information from independent sources. Each DEU receives data from both ADIRUs.

The display SOURCE selector, used on the ground for maintenance purposes, allows manual selection of either DEU1 or DEU2 for all six display units. If the displays are automatically or manually switched to a single DEU source, a "DSPLY SOURCE" annunciation illuminates on both pilot's primary flight display.

The display SOURCE selector switch determines which EFIS control panel controls the pilots' display functions. With the switch positioned to either BOTH ON 1 or BOTH ON 2, the selected EFIS control panel provides inputs for both sets of pilot displays. When in the NORMAL position, a "DISPLAYS CONTROL PANEL" annunciation illuminates below the altitude indication showing a failure of the associated EFIS control panel.

EFIS Control Panels

The EFIS control panels, located on the glareshield, controls display options, mode, and range for the related pilot's displays. Refer to the PFD and ND sections of this chapter for detailed information.

If an EFIS control panel fails, the displays can be controlled by the remaining control panel.

Display Select Panel

The display select panel, located on the left and right forward panels, controls the displays on the inboard, outboard and lower DUs. Normal operation is all selectors in the NORMAL position. The pilots' outboard and inboard DUs display primary flight and navigation data and the upper DU displays primary engine data and fuel quantity.

If a DU fails, automatic display switching ensures critical information remains available to the pilots at all times. If the system detects an operational failure on an outboard DU, the primary flight display automatically moves to the inboard DU and the failed outboard DU blanks. The OUTBD/INDB selector no longer has control over that display unit. If the upper DU fails, the engine display automatically moves to the lower DU.

Manual control of display formats is provided for undetected failures. The outboard rotary switch on the display select panel controls the formats displayed on either the outboard or inboard DUs. The inboard rotary switch controls the display format shown on the lower DU.

Display Selection and Control Examples

The following examples show display selections.

Normal Display Configuration

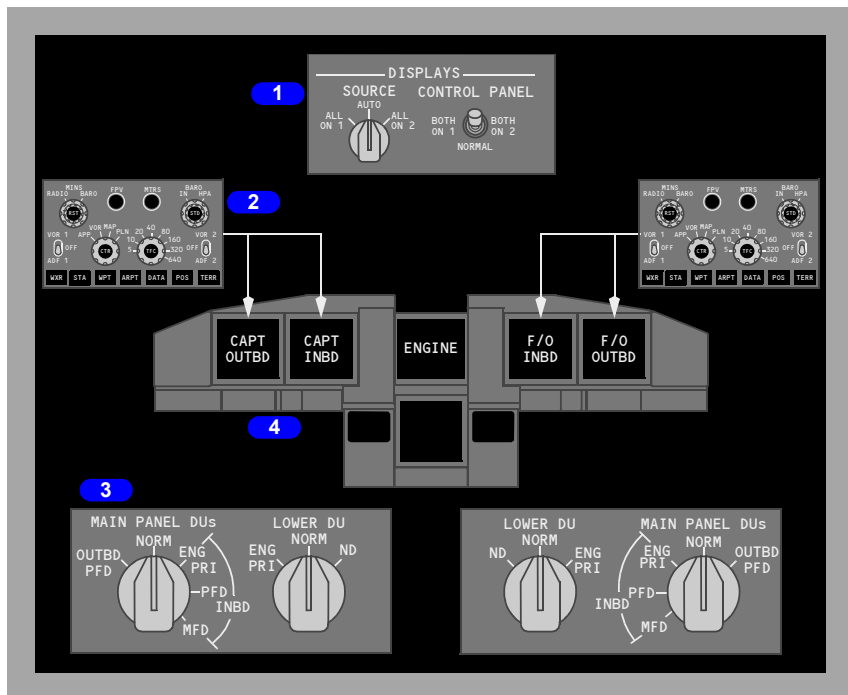

1 DISPLAYS Source Panel

The display SOURCE select switch is in **AUTO** and the CONTROL PANEL select switch is in **NORMAL**.

2 EFIS Control Panel

The left EFIS control panel controls the Captain outboard and inboard display units. The right EFIS control panel controls the First Officer outboard and inboard display units.

3 Display Select Panel

All selectors are in **NORMAL**.

4 Display Units

The pilots' outboard and inboard DUs show the normal PFD/ND displays.

Display Unit Failure Automatic Switching

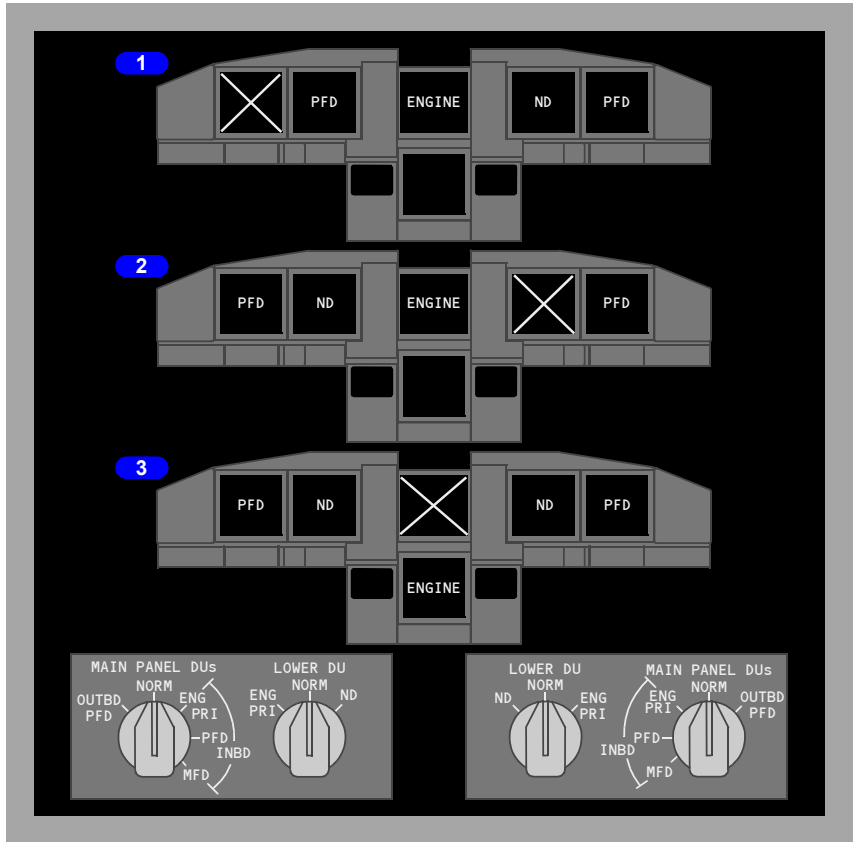

1 Outboard Display Unit Fails

If an outboard display unit fails, the PFD is automatically displayed on the inboard display unit and the outboard display unit blanks.

2 Inboard Display Unit Fails

If an inboard display unit fails, the PFD format remains displayed on the outboard display unit and the inboard display unit blanks.

3 Upper Display Unit Fails

If the upper display unit fails, the primary engine display automatically moves to the lower display unit and the upper display unit blanks. If the secondary engine display is already on the lower display unit, a compact engine display is then displayed.

Note: There is no automatic switching for a lower DU failure.

EFIS Control Panel

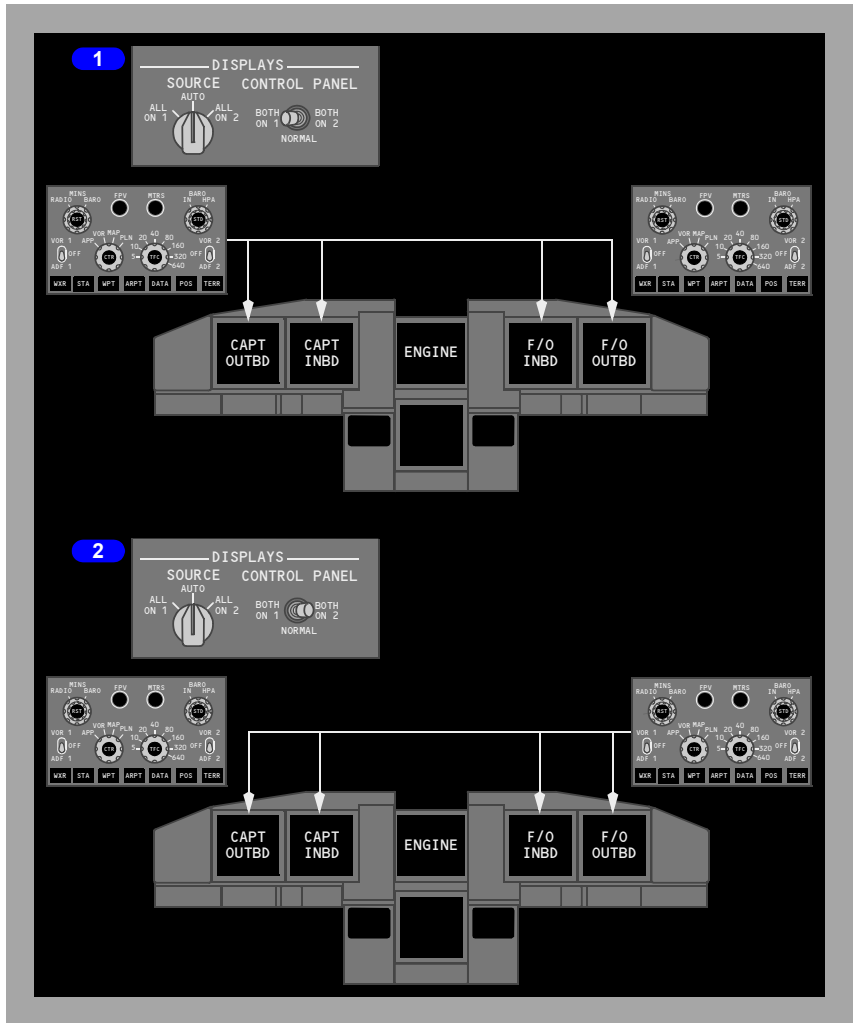

1 CONTROL PANEL Select Switch BOTH ON 1

The left EFIS control panel controls both pilots' outboard and inboard display units.

2 CONTROL PANEL Select Switch BOTH ON 2

The right EFIS control panel controls both pilots' outboard and inboard display units.

Outboard Display Switching

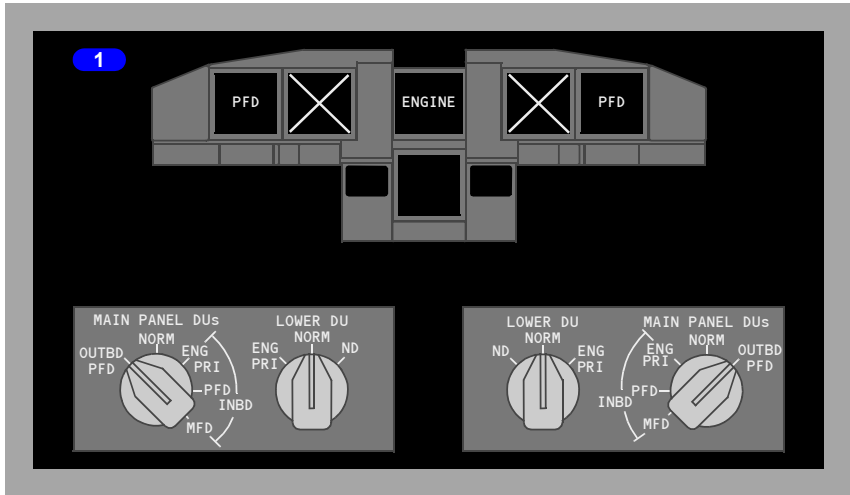

1 MAIN PANEL DUs Switch to OUTBD PFD

If the MAIN PANEL DUs switch is turned to Outboard Primary Flight Display (OUTBD PFD), the PFD format is displayed on the outboard display unit and the inboard display unit blanks.

Inboard Display Switching

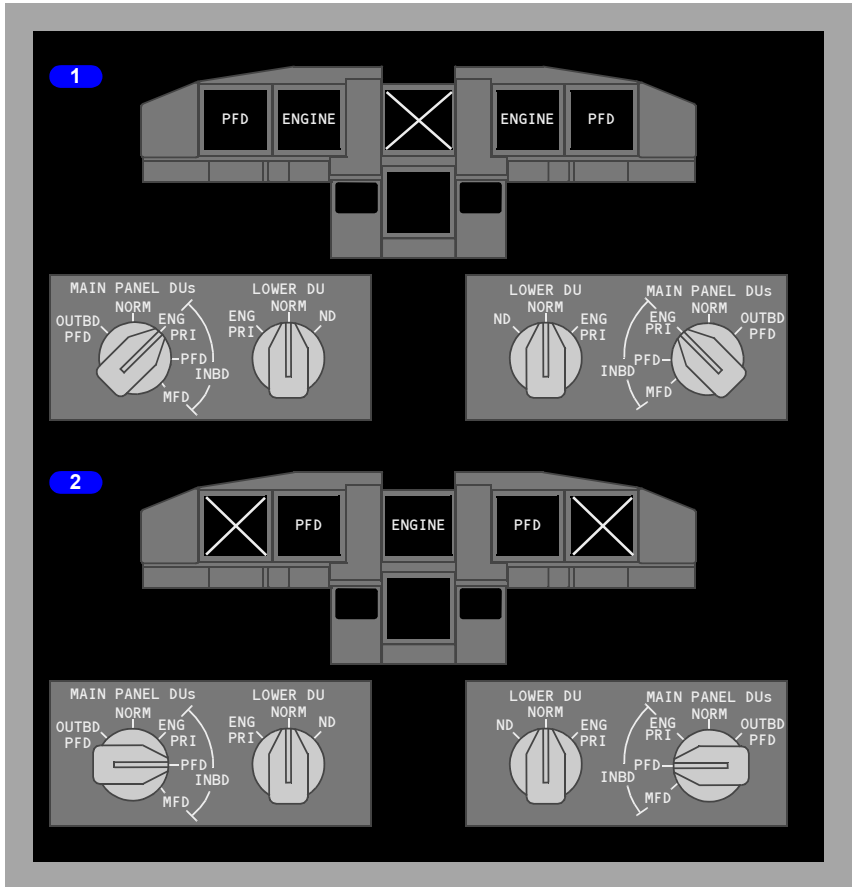

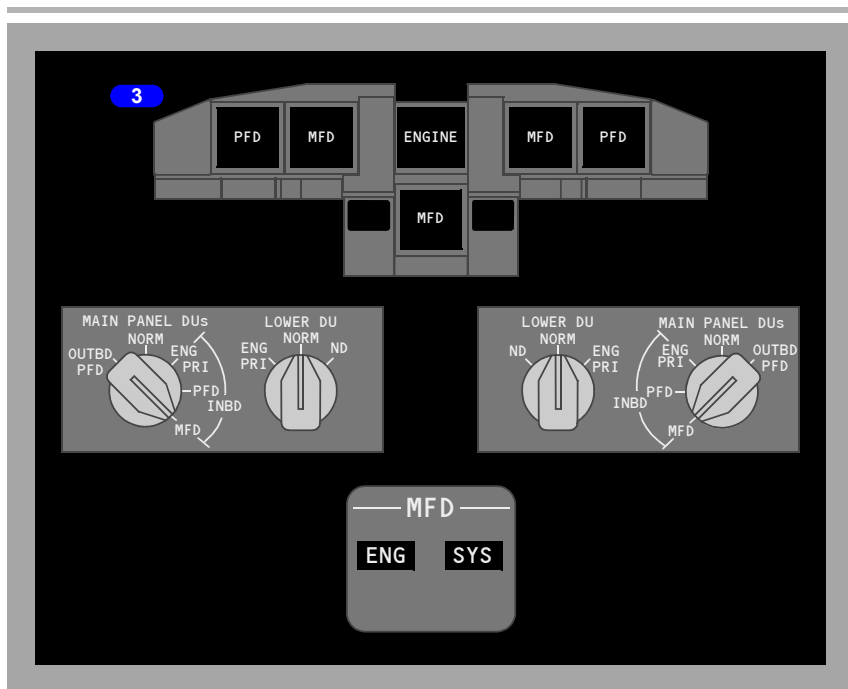

1 MAIN PANEL DUs Switch to INBD ENG PRI

If the MAIN PANEL DUs switch is turned to INBD ENG PRI, the primary engine display moves to the inboard DU, the PFD format is displayed on the outboard DU and the upper DU blanks.

2 MAIN PANEL DUs Switch to INBD PFD

If the MAIN PANEL DUs switch is turned to INBD PFD, the PFD format is displayed on the inboard DU and the outboard DU blanks.

3 MAIN PANEL DUs Switch to MFD

If the MAIN PANEL DUs switch is turned to INBD MFD, the PFD continues to be displayed on the outboard display unit and the inboard display is blank. The system format (SYS) or secondary engine format (ENG) can then be selected to the inboard display unit and lower display unit with the MFD switches on the engine display control unit.

Lower Display Switching

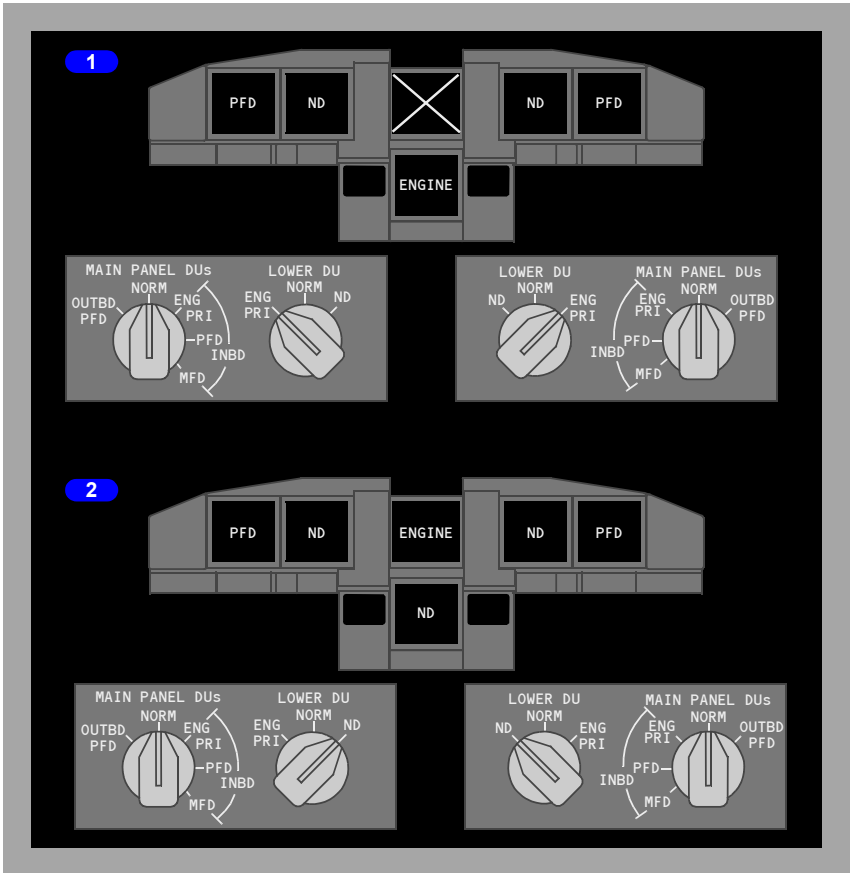

1 LOWER DU Switch to ENG PRI

If the LOWER DU switch is turned to ENG PRI, the engine display moves to the lower DU and the upper DU blanks.

2 LOWER DU Switch to ND

If the LOWER DU switch is turned to ND, the engine display is shown on the upper DU and the navigation display is shown on the lower DU. When the MFD ENG switch is selected, the compact engine display is shown on the upper DU.

Display System Information Sources

Air Data Inertial Reference System (ADIRS)

The ADIRS produces flight data such as position, speed, altitude and attitude for the flight displays, flight management computers, flight controls, engine controls and all other systems requiring inertial and air data.

The major components of the ADIRS are:

- two air data inertial reference units (ADIRUs)
- four air data modules (ADMs)
- one inertial system display unit (ISDU)
- one dual mode select unit (MSU)
- six static ports
- three pitot probes
- two alpha vanes
- one total air temperature probe.

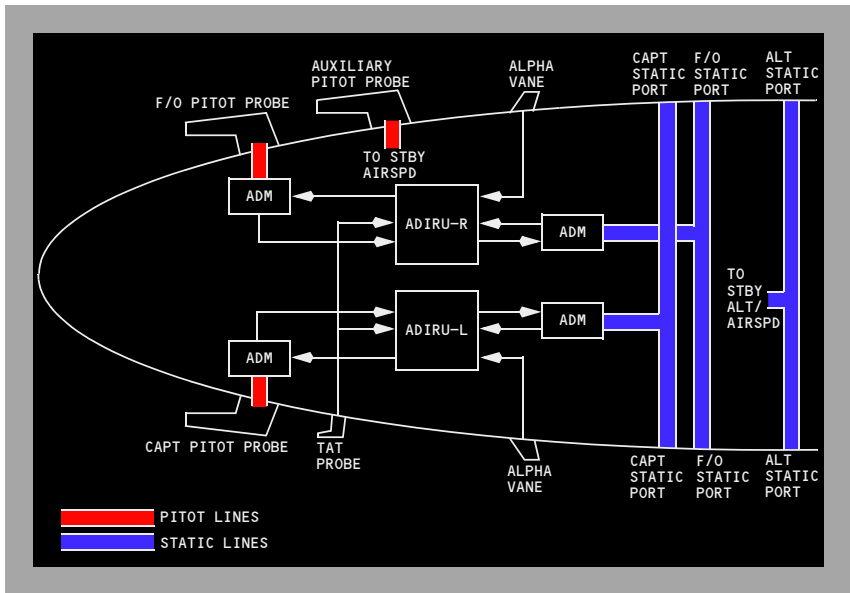

Air Data Inertial Reference Unit (ADIRU)

The ADIRUs provide inertial position and track data to the FMC as well as attitude, altitude and airspeed data to the displays. The ADIRUs process information measured by internal gyros and accelerometers, and from air data module inputs, the alpha vanes and other systems.

The ADIRUs are described in Chapter 11, Flight Management, Navigation.

737 Flight Crew Operations Manual

Air Data

The pitot static system is comprised of three separate pitot probes and six flush static ports. Two pitot probes and four static ports interface with the air data modules. The remaining auxiliary pitot probe and alternate static ports provide pitot and static pressure to the standby instruments. The auxiliary pitot probe is located on the first officer's side of the airplane.

The air data modules convert pneumatic pressure to electrical signals and send these data to the ADIRUs. Each pitot air data module is connected to its on-side pitot probe; there is no cross connection. The air data module connected to the Captain's pitot probe sends information to the left ADIRU, while the air data module connected to the First Officer's pitot probe sends information to the right ADIRU. The remaining air data modules are located at the balance centers of the Captain's and First Officer's static ports. The air data module connected to the Captain's static ports sends information to the left ADIRU, while the air data module connected to the First Officer's static ports sends information to the right ADIRU.

Angle-of-Attack

There are two alpha vanes, one located on each side of the forward fuselage. The vanes measure airplane angle-of-attack relative to the air mass.

Total Air Temperature

A total air temperature probe is mounted outside the airplane to sense air mass temperature. The temperature sensed by the probe is used by the ADIRUs to compute total air temperature.

Static Air Temperature

Static air temperature, displayed on the CDU PROGRESS page, comes from the ADIRUs, using total air temperature probe information.

Standby Flight Instruments

The standby flight instruments include:

- standby magnetic compass
YA373, YC202, YE324, YE325
- standby altimeter/airspeed indicator
YA374 - YA377, YC203 - YE323, YE326
- integrated standby flight display
- standby radio magnetic indicator.

Standby Magnetic Compass

A standard liquid-damped magnetic standby compass is provided. A card located near the compass provides heading correction factors.

Standby Attitude Indicator

YA373, YC202, YE324, YE325

The standby attitude indicator provides attitude information that is independent of the primary attitude displays. The indicator is powered by the battery bus and remains powered after the loss of all normal AC power as long as battery power is available. The gyro reaches operational speed approximately 60 seconds after power is applied. The indicator requires three minutes to achieve accuracy requirements.

Integrated Standby Flight Display (ISFD)

YA374 - YA377, YC203 - YE323, YE326

The ISFD displays attitude, airspeed, altitude, ILS, and magnetic heading information. It is connected directly to the auxiliary pitot and alternate static sources. Attitude information is provided by internal inertial sensors. ILS information is provided by the No. 1 ILS receiver. The display receives its heading information from the same source as the captain's primary flight display. Heading information is not available in polar regions.

Note: The standby magnetic compass must be used to validate heading information.

The battery bus powers the ISFD. Selecting the battery switch ON activates the ISFD. After 10 seconds, an initialization sequence begins that requires 90 seconds to complete. ATT and INIT 90s messages are displayed during initialization. Initialization will stop if airplane movement is excessive and will resume when airplane movement is acceptable for initialization. Upon completion of the initialization sequence, attitude information is displayed.

Detection of a momentary out-of-limit ISFD condition may cause the attitude display to blank and the WAIT ATT or ATT:RST message to display. Operation of the attitude reset switch is required in response to the ATT:RST message. This will reset the horizon line with the airplane symbol.

On the ground, operation of the attitude reset switch must be performed with the airplane stationary. In flight, operation of the attitude reset switch must be performed with the airplane in wings level, non-accelerated flight. During the process, the ATT 10s message displays. Failure to maintain straight and level flight for 10 seconds may result in an ATT:RST message. If the reset attempt is unsuccessful, the ATT:RST message remains displayed and the ISFD does not enter normal operation.

Standby Altimeter/Airspeed Indicator

YA373, YC202, YE324, YE325

Standby altitude and airspeed are displayed on a single indicator.

The standby altimeter receives static pressure from the alternate static ports. Current altitude is displayed digitally. A pointer indicates altitude in hundreds of feet. Barometric setting windows display the barometric setting in both millibars and inches of mercury as set by the barometric setting control. The altimeter has a range of -1000 to 50,000 feet.

The standby airspeed indicator receives ram air pressure from the auxiliary pitot probe and static pressure from the alternate static ports. It provides current airspeed in knots.

Standby Radio Magnetic Indicator

The standby radio magnetic indicator (RMI) displays magnetic heading and VOR/ADF bearing to the station. The RMI is powered by the AC standby bus and remains powered after the loss of all normal AC power as long as battery power is available.

Clocks

Two electronic clocks are installed, with two digital displays on each clock. Universal time coordinated (UTC) time, UTC date, manual time or manual date may be set on the upper time display. The lower ET/CHR display is used for either elapsed time or the chronograph. Separate controls are provided for each display. Each clock is powered by the hot battery bus when the battery bus is not available. The clock reverts to hot battery bus power when the airplane is powered down. The hot battery bus power keeps the time base but does not provide power for the display or output of clock data and the clock reverts to manual mode. When the airplane is powered up and Global Position System (GPS) data is restored, the clock continues to operate in manual mode and will not automatically display UTC time. UTC time can be manually selected by using the TIME/DATE pushbutton.

Note: When on standby power, the F/O clock display is dim and UTC time is not available.

Flight Recorder

The flight recorder provides a permanent record of selected operational and systems information such as altitude, heading, acceleration, and airspeed. The recorder is housed in a sealed, fire-resistant container located behind an access door in the aft cabin ceiling.

Operational and systems information is automatically recorded whenever the flight recorder is powered. On the ground, the recorder begins operating when one of the engines is operating. In the air, the flight recorder is powered even with both engines shut down as long as APU electrical power is available.

Aircraft Condition Monitoring System (ACMS)

The ACMS consists of a digital flight data acquisition unit (DFDAU) and digital flight data recorder (DFDR).

The DFDAU receives signals representing certain flight condition and airplane systems' operating performance and converts them to a digital form for recording on the DFDR.

The DFDR records airplane systems and flight data for at least the last 25 hours of operation. The DFDR is located in the aft fuselage area.



This Section Applies to YA371, YA372, YC201

Introduction

The electronic flight instrument system (EFIS) presents a dynamic color display of the parameters necessary for flight path control. The displays provide the following information:

- flight mode annunciation
- airspeed
- attitude
- steering information
- instrument landing system display
- approach minimums
- radio altitude
- altitude
- vertical speed
- GPWS annunciations
- TCAS indications.

Failure flags are displayed for airplane system failures. Displayed information is removed or replaced by dashes if no valid information is available to the display system (because of out-of-range or malfunctioning navigation aids). Displays are removed when a source fails or when no system source information is available.

Flight mode annunciations are described in Chapter 4, Automatic Flight.

Airspeed

Airspeed is displayed on a round dial Mach/airspeed indicator, or MASI. Current airspeed is displayed by an airspeed pointer and digital counter. Current Mach number is digitally displayed when the Mach number is greater than 0.40. Target airspeed is shown by the magenta airspeed cursor.

Takeoff and landing reference speeds and flap maneuvering speeds are shown along the circumference of the indicator. Maximum and minimum airspeeds are also displayed.

Attitude

The attitude indicator displays airplane pitch and roll attitude referenced to the horizon.

Pitch attitude is displayed by an airplane symbol against a pitch scale. The pitch scale is in 2.5 degree increments.

A pointer indicates bank angle in increments of 10, 20, and 30 degrees. Single marks indicate 45 and 60 degrees of bank. A small rectangle under the bank angle pointer indicates slip and skid conditions. Bank angle is also represented by the attitude of the airplane symbol against the horizon line and pitch scale.

A pitch limit indication is displayed at all times when the flaps are not up, or when flaps are up and airspeed approaches stick shaker activation for existing flight conditions.

Steering Indications

Flight director pitch and roll bars are displayed when the related flight director switch is on. Pitch and roll commands are displayed independently.

The flight path vector (FPV) symbol represents airplane flight path angle vertically and drift angle laterally. The flight path vector is displayed on the attitude indicator when the EFIS control panel FPV switch is selected on. The FPV shows the Flight Path Angle (FPA) above or below the horizon line and drift angle left or right of the pitch scale's center. The FPA uses inertial and barometric altitude inputs. The vertical FPA is unreliable with unreliable primary altitude displays.

The FPV symbol is displayed in two brightness levels. The FPV symbol is displayed dim when either the flight director or a TCAS resolution advisory is displayed. The FPV symbol is displayed bright when the flight director is off and there is no TCAS resolution advisory displayed.

Instrument Landing System Indications

ILS glide slope and localizer deviation are provided.

The glide slope pointer and scale appear on the right side of the attitude indication when a valid signal is received. The scale turns amber and the pointer flashes to indicate an excessive glide slope deviation. The pointer is not displayed when the glide slope signal is unusable or when the track and the front course on the mode control panel differ by more than 90 degrees (backcourse).

The localizer pointer and scale appear at the bottom of the attitude indicator when a valid signal is received. When the course deviation is slightly more than one-half dot and the localizer mode is engaged and track is within 5 degrees of the MCP selected course, the scale automatically expands. At low radio altitudes, with autopilot or flight director engaged, the scale turns amber and the pointer flashes to indicate excessive deviation. Below 1,000 feet AGL, with LNAV engaged and LOC armed, the localizer scale turns amber and the pointer flashes if the localizer is not captured.

Each pilot's deviation alerting system self-tests upon becoming armed at 1500 feet radio altitude. This self-test generates a two second LOC and G/S deviation alerting display on each attitude indicator.

Below 2500 feet radio altitude, with the localizer pointer in view, a rising runway symbol comes into view. The symbol provides lateral guidance. At 200 feet radio altitude, the symbol rises toward the airplane symbol.

Approach Minimums

The selected radio altitude set on the EFIS control panel is displayed near the bottom right of the attitude indicator. The barometric approach minimums is displayed as a marker on the altimeter.

Digital barometric approach minimums are displayed under the altimeter.

Heading Indications

A heading scale is added to the horizon line when the flight path vector is selected on the EFIS control panel, the current bank angle is less than 50 degrees and the absolute pitch angle is less than 20 degrees. The heading scale includes 5 and 10 degree indices with numeric indications aligned with the 10 degree indices. A magenta heading bug is also displayed that represents the MCP selected heading value. For bank angles 50 degrees or greater, the scale is removed to avoid confusion between heading ticks and pitch ticks in the event of unusual attitude recovery.

Radio Altitude

The current radio altitude is displayed near the bottom right of the attitude indicator when radio altitude is below 2,500 feet AGL. When between 1000 feet and 2500 feet AGL, the readout is digital. When below 1000 feet AGL, the readout is displayed in a round dial format. The display turns amber and the circumference flashes for 3 seconds as the radio altitude descends through the selected minimum altitude. The display changes back to white after one of the following occurs:

- when passing the selected minimum altitude plus 75 feet during go-around
- at touchdown
- after pressing the RST switch on the EFIS control panel.

Radio Altitude Alert

The altitude alert is triggered and “ALT” is shown above the radio altitude display when radio altitude is less than or equal to 1500 feet AGL.

Altitude

Altitude is displayed on a round dial altimeter. Current altitude is displayed by an altitude pointer and a digital readout. A green reference altitude marker indicates the barometric minimums set on the EFIS control panel.

When meters is selected on the EFIS control panel, current altitude in meters is shown above the altitude window and the metric altitude equivalent of the selected MCP altitude is displayed above the altimeter. Metric readouts are not available in the compact EFIS mode.

The current barometric reference is displayed in either inches of mercury or hectopascals as selected on the EFIS control panel.

Vertical Speed

Vertical speed is indicated by a vertical speed pointer. The pointer depicts rate of climb or descent from 0 to 6000 feet.

Traffic Alert and Collision Avoidance (TCAS) Indications

TCAS resolution advisories are displayed on the attitude indicator.

Refer to Chapter 15, Warning Systems.

GPWS Warnings

GPWS warnings are displayed in large capital letters on the attitude indicator. Refer to Chapter 15, Warning Systems.



This Section Applies to YA373 - YA377, YC202 - YE326

Introduction

The primary flight displays (PFDs) present a dynamic color display of all the parameters necessary for flight path control. The displays provide the following information:

- flight mode annunciation
- airspeed
- altitude
- vertical speed
- attitude
- steering information
- radio altitude
- instrument landing system display
- approach minimums
- heading/track indications
- TCAS indications
- GPWS annunciations.

Failure flags are displayed for airplane system failures. Displayed information is removed or replaced by dashes if no valid information is available to the display system (because of out-of-range or malfunctioning navigation aids). Displays are removed when a source fails or when no system source information is available.

Flight mode annunciations are described in Chapter 4, Automatic Flight.

Airspeed

Airspeed is displayed on a tape and in a digital window on the left side of the PFD. The current Mach number is digitally displayed below the airspeed tape when the current Mach number is 0.40 Mach or above. Ground speed is displayed when airspeed decreases below 0.40 Mach. An airspeed trend vector indicates predicted airspeed in 10 seconds. Selected airspeed is displayed above the airspeed tape.

Takeoff and landing reference speeds and flap maneuvering speeds are shown along the right edge of the airspeed tape. Maximum and minimum airspeeds are also displayed along the right edge of the airspeed tape.

Once the crew has set Flap/VREF in the MCDU APPROACH REF page, a green “REF” and numerical landing Flap/VREF appears on the PFD. The REF symbol will move vertically adjacent to the reference airspeed, and the numerical display will remain fixed at the base and to the right of the speed tape.

Attitude

The attitude indication displays the airplane pitch and roll attitude referenced to the horizon.

Pitch attitude is displayed by an airplane symbol against a pitch scale. The pitch scale is in 2.5 degree increments.

A pointer indicates bank angle in increments of 10, 20, and 30 degrees. Single marks indicate 45 and 60 degrees of bank. A small rectangle under the bank angle pointer indicates slip and skid conditions. Bank angle is also represented by the attitude of the airplane symbol against the horizon line and pitch scale.

A pitch limit indication is displayed at all times when the flaps are not up, or when flaps are up and airspeed approaches stick shaker activation for existing flight conditions.

Steering Indications

The flight director is displayed when the related flight director switch is on. Pitch and roll commands are displayed independently.

The flight path vector (FPV) symbol represents airplane flight path angle vertically and drift angle laterally. The flight path vector is displayed on the PFD when the EFIS control panel FPV switch is selected on. The FPV shows the Flight Path Angle (FPA) above or below the horizon line and drift angle left or right of the pitch scale's center. The FPA uses inertial and barometric altitude inputs. The vertical FPA is unreliable with unreliable primary altitude displays.

The FPV symbol is displayed in two brightness levels. The FPV symbol is displayed dim when either the flight director or a TCAS resolution advisory is displayed. The FPV symbol is displayed bright when the flight director is off and there is no TCAS resolution advisory displayed.

Instrument Landing System Indications

ILS glide slope and localizer deviation, frequency/identification, DME, course, and marker beacon indications are provided.

The approach reference information appears above and to the left of the attitude display. The ILS station identification or frequency, course, and (if available) DME are displayed.

The marker beacon indication (OM – outer marker, IM – inner marker, or MM – middle marker) is displayed in the upper right corner of the attitude display area.

The glide slope pointer and scale appear on the right side of the attitude indication when a valid signal is received. At low radio altitudes, with autopilot or flight director engaged, the scale turns amber and the pointer flashes to indicate an excessive glide slope deviation. The pointer is not displayed when the glide slope signal is unusable or when the track and the front course on the mode control panel differ by more than 90 degrees (backcourse).

737 Flight Crew Operations Manual

The localizer pointer and scale appear at the bottom of the attitude indication when a valid signal is received. When the course deviation is slightly more than one-half dot, the localizer mode is engaged and track is within 5 degrees of the MCP selected course, the scale automatically expands. At low radio altitudes, with autopilot or flight director engaged, the scale turns amber and the pointer flashes to indicate excessive deviation. Below 1,000 feet AGL, with LNAV engaged and LOC armed, the localizer scale turns amber and the pointer flashes if the localizer is not captured.

Each pilot's deviation alerting system self-tests upon becoming armed at 1500 feet radio altitude. This self-test generates a two second LOC and G/S deviation alerting display on each attitude indicator.

Below 2500 feet radio altitude, with the localizer pointer in view, a rising runway symbol comes into view. The symbol provides lateral guidance. At 200 feet radio altitude, the symbol rises toward the airplane symbol.

Approach Minimums

The selected radio altitude or barometric approach minimums are set on the EFIS control panel. The radio altitude approach minimum is displayed near the top left of the altitude display and the barometric approach minimums is displayed near the bottom left of the altitude display.

Radio Altitude

The current radio altitude is displayed above the upper right corner of the attitude indication area when radio altitude is below 2,500 feet AGL. When between 1000 feet and 2500 feet AGL, the readout is digital. When below 1000 feet AGL, the readout is displayed in a round dial format. The display turns amber when the radio altimeter is below the radio altitude minimums.

Altitude

Altitude is displayed on an altitude tape along the right side of the PFD. It is also shown digitally in a window in the middle of the tape. When meters is selected on the EFIS control panel:

- current altitude in meters is also shown above the altitude window
- selected altitude in meters is displayed above the altitude tape.

Selected altitude is displayed above the altitude tape and is boxed when approaching the selected altitude. Selected altitude is also depicted with a bug on the altitude tape.

YA373 - YA377, YC202 - YC207, YE324 - YE326

The selected barometric approach minimum is indicated on the altitude tape with a triangular pointer and a line when BARO minimums are selected.

YE321 - YE323

The selected barometric approach minimum is indicated on the altitude tape with a triangular pointer and a line when BARO minimums are selected. When RADIO minimums are selected, the pointer is still set at BARO minimums but there is no line.

A landing altitude reference bar is displayed along the inner edge of the altitude indication. The reference bar indicates the height above touchdown. A white bar is displayed from 1000 to 500 feet above landing altitude. An amber bar is displayed from 500 feet to the landing altitude.

A landing altitude indication is displayed as a crosshatched area and indicates:

- the FMC landing altitude for destination runway or airport, or
- the landing altitude for departure runway or airport until 400 NM from departure or one-half the distance to destination, whichever occurs first.

The current barometric reference is displayed below the altitude tape in either inches of mercury or hectopascals as selected on the EFIS control panel. A preselected barometric reference can be displayed when STD is displayed.

YA375 - YA377, YC207

Altitude reference is selectable between QNH and QFE. QNH is the normal operating mode. A description of QFE operation is contained in the CDU Approach Reference Page description in Chapter 11, Flight Management, Navigation.

Vertical Speed

Vertical speed is displayed to the right of the altitude tape with a tape and pointer. Vertical speed is digitally displayed above or below the vertical speed display when vertical speed is greater than 400 feet per minute. It is displayed above with positive vertical speed and below with negative vertical speed. The selected vertical speed bug shows the selected vertical speed when in the AFDS vertical speed (V/S) pitch mode.

Heading/Track Indications

Heading/track information is displayed in the bottom section of the PFD on a section of the compass rose. Current heading is displayed under a pointer at the top of the compass rose. The MCP selected heading is displayed as a bug on the outside of the compass rose and digitally in the left half of the compass rose.

737 Flight Crew Operations Manual

The current heading/track reference (MAG/TRU) is shown in the right half of the compass rose. A line drawn perpendicular to the edge of the compass rose from the invisible center depicts the current airplane track.

YE321 - YE323

A heading scale is added to the horizon line when the flight path vector is selected on the EFIS control panel, the current bank angle is less than 50 degrees and the absolute pitch angle is less than 20 degrees. The heading scale includes 5 and 10 degree indices with numeric indications aligned with the 10 degree indices. A magenta heading bug is also displayed that represents the MCP selected heading value. For bank angles 50 degrees or greater, the scale is removed to avoid confusion between heading ticks and pitch ticks in the event of unusual attitude recovery.

Traffic Alert and Collision Avoidance (TCAS) Indications

TCAS resolution advisories are displayed in the attitude indication area.

Refer to Chapter 15, Warning Systems.

GPWS Warnings

GPWS warnings are displayed in large capital letters between the attitude display and the heading/track compass rose. Refer to Chapter 15, Warning Systems.

Intentionally
Blank



This Section Applies to YA371, YA372, YC201

Introduction

The navigation displays provide a color display of flight progress. The displays consist of the following:

- horizontal situation indicator
- radio distance magnetic indicator
- navigation display with MAP, APP (approach), VOR, and PLN (plan) modes.

The MAP, VOR, and APP modes can be switched between an expanded mode with a partial compass rose and a center mode with a full compass rose.

Horizontal Situation Indicator (HSI)

The HSI provides heading and track data with VOR navigation or ILS approach information. The data are normally displayed on a compass rose with 200 degrees of heading. In the compact EFIS mode, the data are presented on a 360 degree display.

Radio Distance Magnetic Indicator (RDMI)

The RDMI provides the same information as a conventional RDMI.

Navigation Display – MAP Mode

The MAP mode is recommended for most phases of flight. This mode shows airplane position relative to the route of flight against a moving map background.

Displayed information can include:

- current track
- selected and current heading
- position trend vector
- range to selected altitude
- map range scale
- ground speed
- true airspeed
- wind direction and speed
- next waypoint distance
- waypoint estimated time of arrival
- selected navigation data points.

Navigation Data Points

Additional navigation facility (STA), waypoint (WPT), airport (ARPT), route progress (DATA) and position (POS) data are available for display in both the expanded and center MAP modes.

VOR and Approach Modes

The VOR and APP modes are presented heading up. The VOR and APP modes display track, heading, and wind speed and direction with VOR navigation or approach information.

Plan Mode

The PLN mode is presented true north up. The active route may be viewed using the STEP prompt on the CDU LEGS pages.

Navigation Display Information

Heading

Heading is supplied by air data inertial reference system (ADIRS). The compass rose can be referenced to magnetic north or true north.

Track

Track is supplied by the FMC during normal operation.

Traffic

Traffic information from the TCAS can be displayed on the navigation display when in MAP, Center MAP, APP and VOR modes. TCAS is described in Chapter 15, Warning Systems.

Weather Radar

Weather radar information can be displayed on the navigation display when in MAP, Center MAP, APP and VOR modes. The weather radar system is described in Chapter 11, Flight Management, Navigation.

Failure Flags and Messages

Failure flags are displayed for system failures or invalid information. Indications are removed or replaced by dashes when source system information is not available.

The message EXCESS DATA is displayed if the amount of information sent to the navigation display exceeds the display capability. The message can be removed by:







- reducing the amount of map information
- reducing range, or
- deselecting one or more of the EFIS control panel map switches (STA, WPT, ARPT, DATA, POS).



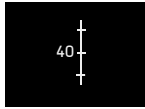

Navigation Display Symbolology

The following symbols can be displayed, depending on EFIS control panel switch selections. Colors indicate the following:

- W (white) – present status, range scales
- G (green) – dynamic conditions
- M (magenta) – command information, pointers, symbols, fly-to condition
- C (cyan) – nonactive or background information
- A (amber) – cautions, faults, flags
- R (red) – warnings
- B (black) – blank area, off condition.

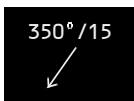
Heading, Track, and Speed

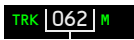



SYMBOL	NAME	MODE	REMARKS
	Selected heading bug (M)	All except PLN	Displays the MCP-selected heading. A dashed reference line (M) extends from the marker to the airplane symbol (VOR CTR and APP CTR do not display dashed line).
	Current heading pointer (W)	All except PLN	Points to current heading on the compass rose.
	Track line and range scale (W)	MAP, MAP CTR, APP, VOR	Indicates current track.
	Expanded compass (W)	MAP, APP, VOR	Displays 60 degrees of compass rose.
	Groundspeed (W)	All	Current ground speed.
	True airspeed (W)	All	Current true airspeed displayed above 100 knots.



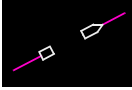

SYMBOL	NAME	MODE	REMARKS
	Wind direction/speed and wind arrow (W)	All	Indicates wind speed and direction, with respect to display orientation and heading/track reference. Displayed if wind magnitude is greater than 6 knots and blanked if wind magnitude becomes less than 4 knots. Blank until TAS is greater than 101 knots. PLN mode displays speed/direction only.
	Heading/track reference (G), box (W) in TRU, box (A) if TRU displayed in descent	All except PLN	Indicates heading/track is referenced to magnetic north or true north. On transition from TRU to M, a highlight box is displayed around M for 10 seconds. When TRU is the reference, the highlight box is displayed full time (white).
	Track orientation (G), current track (W), track reference (G)	MAP, MAP CTR	Displays TRK as the orientation, the current track, and MAG or TRU as the reference, and points to the heading on the compass rose.
	Heading orientation (G), current heading (W), heading reference (G), heading pointer (W)	VOR, VOR CTR, APP, APP CTR	Displays HDG as the display orientation, current heading, MAG or TRU as the heading reference, and points to the heading on the compass rose.

Radio Navigation

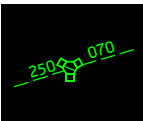
SYMBOL	NAME	MODE	REMARKS
	ILS/VOR frequency display (G)	APP, APP CTR, VOR, VOR CTR	Displays frequency of manually tuned navaid.

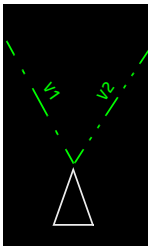
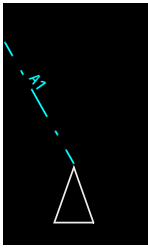
737 Flight Crew Operations Manual

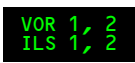
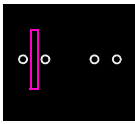



SYMBOL	NAME	MODE	REMARKS
	DME distance (W)	APP, APP CTR, VOR, VOR CTR	Indicates DME distance to the reference navaid.
	Selected course pointer (W) and line (M)	VOR, APP	Displays selected course as set by the related MCP course selector.
	Selected course pointer (W) TO/FROM pointer (W)	APP CTR, VOR CTR	Displays selected course as set by the related MCP course selector. TO/FROM pointer is displayed when VOR navigation is being used.
	To/from indication (W)	VOR, VOR CTR	Displays VOR to/from indication.
	VOR (C, G), DME/TACAN (C, G), VORTAC (C, G)	MAP, MAP CTR, PLN	When the EFIS control panel STA map switch is selected on, appropriate navaids are displayed. All navaids contained in the FMC data base and within the MAP area are displayed when the selected range is 5, 10, 20 or 40 nm. Only high altitude navaids are displayed when the selected range is 80, 160, 320 or 640 nm. Nav aids not being used are displayed in cyan. Manually tuned VHF navaids are displayed in green, regardless of STA map switch selection.
	Manually tuned VOR radials (G)	MAP, MAP CTR, PLN	When a navaid is manually tuned, the selected course and reciprocal are displayed.



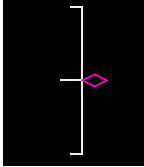
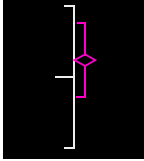

SYMBOL	NAME	MODE	REMARKS
	VOR radials (G)	MAP, MAP CTR	When the POS map switch is selected on and a valid VOR signal is received, the station radial is displayed.
	ADF bearings (C)	MAP, MAP CTR	When the POS map switch is selected on and a valid ADF signal is received, the relative bearing to the tuned ADF station is displayed.
	ADF (C) pointer head and tail	All except PLN	Indicates bearing to (head) or from (tail) the tuned station. Not displayed if POS selected on the EFIS control panel.
	System source annunciation (G)	VOR, VOR CTR, APP, APP CTR	Indicates the selected receiver as the display reference.
	ILS localizer or VOR course deviation indication (M) and scale (W)	VOR, VOR CTR, APP, APP CTR	Displays LOC or VOR course deviation.
	Glide slope pointer (M) and scale (W)	APP, APP CTR	Displays glide slope position and deviation.

MAP



SYMBOL	NAME	MODE	REMARKS
	Airplane symbol (W)	VOR CTR, APP CTR	Current airplane position is at the center of the symbol.

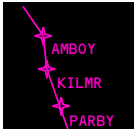





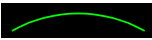
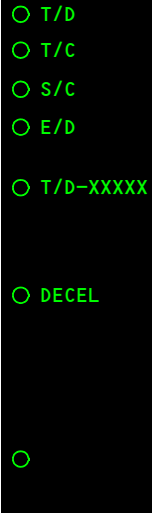
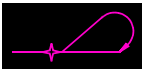

737 Flight Crew Operations Manual

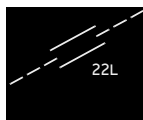
SYMBOL	NAME	MODE	REMARKS
	Airplane symbol (W)	PLN	Indicates actual position and track along the flight plan route. Inhibited north of 82N latitude and south of 82S latitude.
	VNAV path pointer (M) and deviation scale (W)	MAP, MAP CTR	Displays vertical deviation from selected VNAV PATH during descent only. Scale indicates \pm 400 feet deviation. Digital display is provided when the pointer is off the scale.
	Path deviation band (M)	MAP, MAP CTR	Path deviation band is symmetric about the pointer and represents vertical RNP.
	Position trend vector (W) (dashed line)	MAP, MAP CTR	Predicts position at the end of 30, 60, and 90 second intervals. Each segment represents 30 seconds. Based on bank angle and ground speed. Selected range determines the number of segments displayed. For range: <ul style="list-style-type: none"> • > 20 NM, 3 segments • = 20 NM, 2 segments • \leq 10 NM, 1 segment.
	Active waypoint identifier (M)	MAP, MAP CTR, PLN	Indicates the active flight plan waypoint, the next waypoint on the route of flight.
	Active waypoint distance (W)	MAP, MAP CTR, PLN	Distance to the active waypoint.
	Active waypoint ETA (W)	MAP, MAP CTR, PLN	Indicates FMS-calculated ETA at the active waypoint.

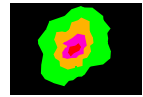
SYMBOL	NAME	MODE	REMARKS
	Waypoint: active (M), modified (W), inactive (C)	MAP, MAP CTR, PLN	Active– represents the waypoint the airplane is currently navigating to. Modified – represents the waypoints on the active route that are being modified. Inactive – represents the waypoints on the active route.
	Off route waypoint (C)	MAP, MAP CTR, PLN	When the EFIS control panel WPT map switch is selected on, waypoints not on the selected route are displayed, for ranges of 5, 10, 20, or 40 NM.
	Flight plan route: active (M), modified (W), inactive (C), offset (M)	MAP, MAP CTR, PLN	The active route is displayed with a continuous line (M) between waypoints. Active route modifications are displayed with short dashes (W) between waypoints. Inactive routes are displayed with long dashes between waypoints. An offset route, selected through the FMC, is displayed with a dot-dash line (M) parallel to the active route.
	Route data: active (M), inactive (W)	MAP, MAP CTR, PLN	When the EFIS control panel DATA switch is selected on, entered or procedural altitude and ETAs for route waypoints are displayed.
	Holding pattern: active (M), modified (W), inactive (C)	MAP, MAP CTR, PLN	A holding pattern appears when in the flight plan. The holding pattern appears as a fixed size if the selected range is greater than 80 NM. A scaled representation of the holding pattern is displayed when the selected range is 80 NM or less and the airplane is within 3 minutes of the holding fix.

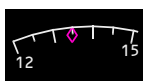
737 Flight Crew Operations Manual







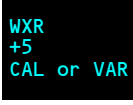

SYMBOL	NAME	MODE	REMARKS
	Altitude range arc (G)	MAP, MAP CTR	Based on vertical speed and groundspeed, indicates the approximate map position where the MCP altitude will be reached.
	Altitude profile point and identifier (G)	MAP, MAP CTR, PLN	Indicates the approximate map position of the FMC-calculated T/C (top-of-climb), T/D (top- of-descent), S/C (step climb), and E/D (end of descent) points. Indicates intermediate T/D points for level flight path segments during descent. Level flight path segment altitude is displayed. Indicates the beginning of a deceleration segment resulting from deceleration to a holding pattern, a waypoint speed restriction or flaps up maneuvering speed. Indicates airport speed restriction deceleration point (no identifier).
	Procedure turn: active (M), modified (W), inactive (C)	MAP, MAP CTR, PLN	A procedure turn appears when in the flight plan. The procedure turn appears as a fixed size if the selected range is greater than 80 NM. A scaled representation of the procedure turn is displayed when the selected range is 80 NM or less and the airplane is within 3 minutes of the procedure turn.
	Airport and runway (W)	MAP, MAP CTR, PLN	Displayed when selected as the origin or destination and selected range is 80, 160, 320, or 640 NM.
	Airport (C)	MAP, MAP CTR, PLN	Displayed if the EFIS control panel ARPT map switch is selected on. Origin and destination airports are always displayed, regardless of map switch selection.

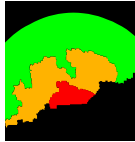
SYMBOL	NAME	MODE	REMARKS
	Airport and runway (W)	MAP, MAP CTR, PLN	Displayed when selected as the origin or destination and selected range is 5, 10, 20, or 40 NM. Dashed runway centerlines extend 14.2 NM.
	Selected reference point and bearing distance information (G)	MAP, MAP CTR, PLN	Displays the reference point selected on the CDU FIX page. Bearing and/or distance from the fix are displayed with dashes (G).
	Weather radar returns (R, A, G, M)	MAP, MAP CTR, VOR, APP	The most intense areas are displayed in red, lesser intensity in amber, and lowest intensity green. Turbulence is displayed in magenta.
	Selected map options (C)	MAP, MAP CTR, PLN	Displays EFIS control panel selected map options.
	Drift angle pointer (W)	VOR CTR, APP CTR	Indicates airplane's present track. Replaces track line in the center APP and VOR modes.
	Position difference display (W)	MAP, MAP CTR	Values indicate NM difference between present FMC position and IRS-L/R present positions. The selected IRS source is displayed on the first line. Arrows indicate the relative bearing to IRS present positions. Displayed when the position difference of the IRS-L and/or IRS-R exceeds limits.
	Position shift: Active (M), Update (W), Other position (G)	PLN	Displays the position of each navigation sensor. Symbols only appear if the POS SHIFT page is displayed on the CDU.
	MAP source annunciation (G)	MAP, MAP CTR, PLN	Displays source of FMC data used by CDS for data presentation.



737 Flight Crew Operations Manual

SYMBOL	NAME	MODE	REMARKS
	Range arcs (W)	MAP, VOR, APP	Displayed in APP and VOR modes when the WXR map, TERR map or TCAS TFC switches are selected. Displayed full time in MAP mode.
	Weather radar annunciations: Mode (C), Tilt (C), Gain (C)	MAP, MAP CTR, VOR, APP	Annunciations vary with option selected

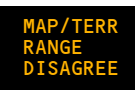



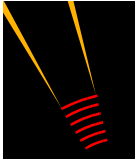

Look-Ahead Terrain

SYMBOL	NAME	MODE	REMARKS
	Terrain display (R, A, G, M)	MAP, MAP CTR, VOR, APP	Displays terrain data from the GPWS terrain data base. Color and density vary based on terrain height vs. airplane altitude. Refer to Chapter 15, Warning Systems.
	Terrain mode annunciation (C)	MAP, MAP CTR, VOR, APP	Terrain display enabled (manual or automatic display).
	Terrain test mode annunciation (C)	All	GPWS operating in self-test mode.
	Terrain annunciation (R, A)	All	Look-ahead terrain caution alert active (A), look-ahead terrain warning alert active (R).
	Terrain status annunciations (A)	All	Look-ahead terrain alerting and display have failed.
	Terrain status annunciations (A)	All	Look-ahead terrain alerting and display unavailable due to position uncertainty.
	Terrain status annunciations (A)	All	GPWS terrain inhibit switch in TERR INHIBIT position.
	Terrain range status annunciations (A)	MAP, MAP CTR, VOR, APP	Terrain output range disagrees with selected EFIS control panel range.
	Terrain range status annunciations (A)	MAP, MAP CTR	Terrain output range and map display output range disagree with selected EFIS control panel range.

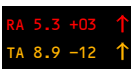

Predictive Windshear

SYMBOL	NAME	ND MODE	REMARKS
	Predictive windshear symbol (R, B, A)	MAP, MAP CTR, VOR, APP	Displays windshear location and approximate geometric size (width and depth). Amber radials extend from predictive windshear symbol to help identify location of windshear event.
	Windshear annunciation (R, A)	All	Predictive windshear caution active (A). Predictive windshear warning active (R).
	Predictive windshear status annunciation (A)	All	Predictive windshear alerting and display have failed.

TCAS

SYMBOL	NAME	MODE	REMARKS
	TCAS resolution advisory (RA), relative altitude (R)	MAP, MAP CTR, VOR, APP	These symbols are displayed only when the EFIS control panel traffic (TFC) switch is selected on. Refer to Chapter 15, Warning Systems. The arrow indicates traffic climbing or descending at a rate ≥ 500 fpm. At rates < 500 fpm, the arrow is not displayed. For relative altitude symbols, the number and associated signs indicate altitude of traffic in hundreds of feet relative to the airplane. For absolute altitude symbols, the number indicates altitude of traffic in thousands and hundreds of feet. For both relative and absolute altitude, the number is below the traffic symbol when the traffic is below, and above the traffic symbol when the traffic is above the airplane. Absence of the number implies altitude unknown.
	TCAS traffic advisory (TA), relative altitude (A)		
	TCAS proximate traffic, relative altitude (W)		
	TCAS other traffic, relative altitude (W)		
	TCAS TA, absolute altitude (A)		
	TCAS no bearing message (RA-R, TA-A)	MAP, MAP CTR, VOR, APP	Message provides traffic type, range in NM, altitude and vertical direction. TFC must be selected on.
	TCAS traffic alert message (RA-R, TA-A)	All	Displayed whenever a TCAS RA or TA is active. EFIS control panel TFC switch does not have to be selected on.
	TCAS off scale message (RA-R, TA-A)	MAP, MAP CTR, VOR, APP	Displayed whenever RA or TA traffic is outside the traffic area covered by the ND range. Displayed only if the EFIS control panel TFC switch is selected on.

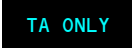
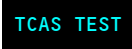
737 Flight Crew Operations Manual

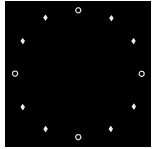
SYMBOL	NAME	MODE	REMARKS
	TCAS mode (C)	MAP, MAP CTR, VOR, APP	Indicates the ND TCAS display is active; the EFIS control panel TFC switch is selected on.
	TCAS mode (C)	All	Indicates TCAS computer is not computing RAs. Displayed whether the EFIS control panel TFC switch is selected on or off.
	TCAS mode (C)	All	Indicates TCAS is operating in the test mode. Displayed whether EFIS control panel TFC switch is selected on or off.
	TCAS mode (A)	All	Displayed when the TCAS/ATC mode switch is not in TA ONLY or TA/RA, if traffic is selected. Not displayed if TCAS is failed.
	TCAS mode (A)	All	Indicates TCAS failure, if traffic is selected.
	Range Ring (W)	MAP, MAP CTR, VOR, APP	Displayed when TFC selected on EFIS Control Panel. Shows 3 NM range ring oriented to aircraft heading. Displayed at ranges of 80 NM or less.

Intentionally
Blank



This Section Applies to YA373 - YA377, YC202 - YE326

Introduction

The NDs provide a mode-selectable color flight progress display. The modes are:

- MAP
- VOR
- APP (approach)
- PLN (plan).

The MAP, VOR, and APP modes can be switched between an expanded mode with a partial compass rose and a centered mode with a full compass rose.

Map Mode

The MAP mode is recommended for most phases of flight. This mode shows airplane position relative to the route of flight against a moving map background.

Displayed information can include:

- current track
- selected and current heading
- position trend vector
- range to selected altitude
- map range scale
- ground speed
- true airspeed
- wind direction and speed
- next waypoint distance
- waypoint estimated time of arrival
- selected navigation data points.

Navigation Data Points

Additional navigation facility (STA), waypoint (WPT), airport (ARPT), route progress (DATA) and position (POS) data are available for display on the ND in both the expanded and center map modes.

VOR and Approach Modes

The VOR and APP modes are presented heading up. The VOR and APP modes display track, heading, and wind speed and direction with VOR navigation or approach information.

Plan Mode

The PLN mode is presented true north up. The active route may be viewed using the STEP prompt on the CDU LEGS pages.

ND Information

Heading

Heading is supplied by the FMC or air data inertial reference system (ADIRS). The ND compass rose can be referenced to magnetic north or true north.

Track

Track is supplied by the FMC during normal operation.

Traffic

Traffic information from the TCAS can be displayed on the ND. TCAS is described in Chapter 15, Warning Systems.

Weather Radar

Weather radar information can be displayed on the ND. The weather radar system is described in Chapter 11, Flight Management, Navigation.

Failure Flags and Messages

Failure flags are displayed for system failures or invalid information. Indications are removed or replaced by dashes when source system information is not available.

The message EXCESS DATA is displayed if the amount of information sent to the ND exceeds the display capability. When this occurs, the primary display system removes information from the outer edge of the display. The message can be removed by:







- reducing the amount of map information
- reducing range, or
- deselecting one or more of the EFIS control panel map switches (STA, WPT, ARPT, DATA, POS).

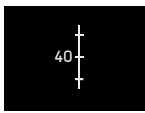

ND Symbolology

The following symbols can be displayed on each ND, depending on EFIS control panel switch selections. Colors indicate the following:



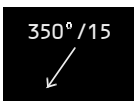

- W (white) – present status, range scales
- G (green) – dynamic conditions
- M (magenta) – command information, pointers, symbols, fly-to condition
- C (cyan) – nonactive or background information
- A (amber) – cautions, faults, flags
- R (red) – warnings
- B (black) – blank area, off condition.

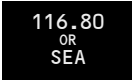

Heading, Track, and Speed

SYMBOL	NAME	MODE	REMARKS
	Selected heading bug (M)	All except PLN	Displays the MCP–selected heading. A dashed reference line (M) extends from the marker to the airplane symbol (VOR CTR and APP CTR do not display dashed line). In the MAP mode with LNAV or VORLOC engaged, the dashed line is removed 10 seconds after the selected heading bug is moved.
	Current heading pointer (W)	All except PLN	Points to current heading on the compass rose.
	Track line and range scale (W)	All except PLN	Indicates current track. Number indicates range (VOR CTR and APP CTR do not display range).
	Expanded compass (W)	MAP, VOR, APP	Displays 90 degrees of compass rose.
	Groundspeed (W)	All	Current ground speed.
	True airspeed (W)	All	Current true airspeed displayed above 100 knots.

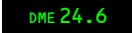
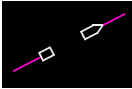

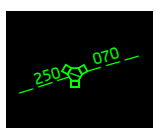
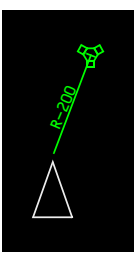

SYMBOL	NAME	MODE	REMARKS
	Wind direction/ speed and wind arrow (W)	All	Indicates wind speed and direction, with respect to display orientation and heading/track reference. Displayed if wind magnitude is greater than 6 knots and blanked if wind magnitude becomes less than 4 knots. Blank until TAS is greater than 101 knots. PLN mode displays speed/direction only.
	Track orientation (G), current track (W), track reference (G)	MAP, MAP CTR	Displays TRK as the orientation, the current track, and MAG or TRU as the reference, and points to the heading on the compass rose.
	Heading orientation (G), current heading (W), heading reference (G), heading pointer (W)	VOR, VOR CTR, APP, APP CTR	Displays HDG as the display orientation, current heading, MAG or TRU as the heading reference, and points to the heading on the compass rose.

Radio Navigation

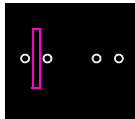

SYMBOL	NAME	MODE	REMARKS
	ILS /VOR Reference receiver frequency or identifier display (W)	VOR, VOR CTR, APP, APP CTR	Located upper right corner. Frequency displayed before the identifier is decoded. The decoded identifier replaces the frequency. Medium size characters for VOR, small size characters for DME only.
	Reference ILS or VOR course (W)	VOR, VOR CTR, APP, APP CTR	Located upper right corner. Indicates the VOR course or ILS localizer course.
	Reference VOR or ILS DME (W)	VOR, VOR CTR, APP, APP CTR	Located upper right corner. Indicates DME distance to the reference navaid.
	DME distance (G)	All except PLN	Located lower left or right corner. Indicates DME distance to navaid.
	Selected course pointer (W) and line (M)	VOR, APP	Displays selected course as set by the related MCP course selector.
	Selected course pointer (W) TO/FROM pointer (W)	APP CTR, VOR CTR	Displays selected course as set by the related MCP course selector. TO/FROM pointer is displayed when VOR navigation is being used.
	To/from indication (W)	VOR, VOR CTR	Displays VOR to/from indication.

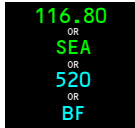
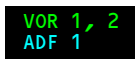
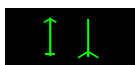
SYMBOL	NAME	MODE	REMARKS
	VOR (C, G), DME/TACAN (C, G), VORTAC (C, G)	MAP, MAP CTR, PLN	When the EFIS control panel STA map switch is selected on, appropriate navaids are displayed. All navaids contained in the FMC data base and within the MAP area are displayed when the selected range is 5, 10, 20 or 40 nm. Only high altitude navaids are displayed when the selected range is 80, 160, 320 or 640 nm. Nav aids not being used are displayed in cyan. Manually tuned VHF navaids are displayed in green, regardless of STA map switch selection.
	Manually tuned VOR radials (G)	MAP, MAP CTR, PLN	When a navaid is manually tuned, the selected course and reciprocal are displayed.
	VOR/DME raw data radial and distance (G)	MAP, MAP CTR	When the POS map switch is selected on, the station radial extends to the airplane.
	System source annunciation (G)	VOR, VOR CTR, APP, APP CTR	Indicates the selected receiver as the display reference.

737 Flight Crew Operations Manual

SYMBOL	NAME	MODE	REMARKS
	ILS localizer or VOR course deviation indication (M) and scale (W)	VOR, VOR CTR, APP, APP CTR	Displays LOC or VOR course deviation. Deviation indicator points in direction of VOR or ILS selected course. For ILS deviation, indicator fills (M) when less than 2 1/2 dots from center.
	Glide slope pointer (M) and scale (W)	APP, APP CTR	Displays glide slope position and deviation.
	VOR frequency or identifier (G), ADF frequency or identifier (C)	All except PLN	Located lower left or right corner. Frequency is displayed before identifier is decoded. Decoded identifier replaces the frequency. For VORs, small size characters indicate only DME information is being received.
	VOR (G) or ADF (C) selection	All except PLN	Located lower left or right corner. Represents positions of the EFIS control panel VOR/ADF switches.
	VOR 1 (G) or ADF 1 (C) pointer head and tail	All except PLN	Indicates bearing to (head) or from (tail) the tuned station, if selected on the respective EFIS control panel.
	VOR 2 (G) pointer head and tail	All except PLN	Indicates bearing to (head) or from (tail) the tuned station, if selected on the respective EFIS control panel.

Map

SYMBOL	NAME	MODE	REMARKS
	Airplane symbol (W)	VOR CTR, APP CTR	Current airplane position is at the center of the symbol.
	Airplane symbol (W)	PLN	Indicates actual position and track along the flight plan route. Inhibited north of 82N latitude and south of 82S latitude.

YA373 - YA377, YC202 - YC207, YE324 - YE326

	Airplane symbol (W)	MAP, MAP CTR, VOR, APP	Current airplane position is at the apex of the triangle.
--	---------------------	---------------------------------	---

YE321 - YE323

	Airplane symbol (W)	MAP, MAP CTR, VOR, APP	Current airplane position is at the apex of the triangle. Displays lateral path deviation distance in MAP and MAP CTR mode only.
--	---------------------	---------------------------------	--



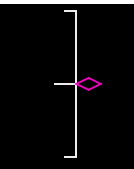

YA373 - YA376, YC202 - YC206, YE321 - YE326

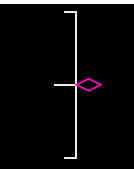

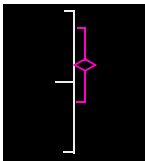
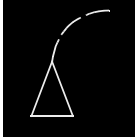

	VNAV path pointer (M) and deviation scale (W)	MAP, MAP CTR	Displays vertical deviation from selected VNAV PATH during descent only. Scale indicates \pm 400 feet deviation. Digital display is provided when the pointer is off the scale.
---	---	-----------------	---

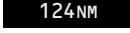
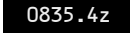
YA377, YC207

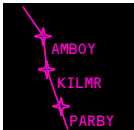

	VNAV path pointer (M) and deviation scale (W)	MAP, MAP CTR	Displays vertical deviation from selected VNAV PATH during descent only. Scale indicates \pm 400 feet deviation. Digital display is provided when the pointer deviates more than \pm 30 feet from center.
--	---	-----------------	---







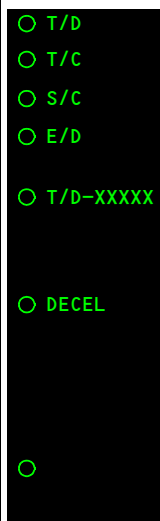
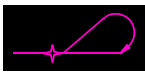

737 Flight Crew Operations Manual

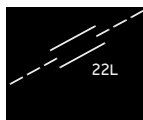
SYMBOL	NAME	MODE	REMARKS
YE321 - YE323			
	Path deviation band (M)	MAP, MAP CTR	Path deviation band is symmetric about the pointer and represents vertical RNP.
	Position trend vector (W) (dashed line)	MAP, MAP CTR	Predicts position at the end of 30, 60, and 90 second intervals. Each segment represents 30 seconds. Based on bank angle and ground speed. Selected range determines the number of segments displayed. For range: <ul style="list-style-type: none"> • > 20 NM, 3 segments • = 20 NM, 2 segments • <= 10 NM, 1 segment.
	Active waypoint identifier (M)	MAP, MAP CTR, PLN	Indicates the active flight plan waypoint, the next waypoint on the route of flight.
	Active waypoint distance (W)	MAP, MAP CTR, PLN	Distance to the active waypoint.
	Active waypoint ETA (W)	MAP, MAP CTR, PLN	Indicates FMS-calculated ETA at the active waypoint.
	Waypoint: active (M), modified (W), inactive (C)	MAP, MAP CTR, PLN	Active – represents the waypoint the airplane is currently navigating to. Modified – represents the waypoints on the active route that are being modified. Inactive – represents the waypoints on the active route.



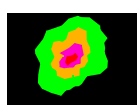

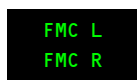

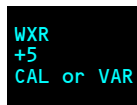

SYMBOL	NAME	MODE	REMARKS
	Off route waypoint (C)	MAP, MAP CTR, PLN	When the EFIS control panel WPT map switch is selected on, waypoints not on the selected route are displayed, for ranges of 5, 10, 20, or 40 NM.
	Flight plan route: active (M), modified (W), inactive (C), offset (M)	MAP, MAP CTR, PLN	The active route is displayed with a continuous line (M) between waypoints. Active route modifications are displayed with short dashes (W) between waypoints. Inactive routes are displayed with long dashes between waypoints. An offset route, selected through the FMC, is displayed with a dot-dash line (M) parallel to the active route.
	Route data: active (M), inactive (W)	MAP, MAP CTR, PLN	When the EFIS control panel DATA switch is selected on, entered or procedural altitude and ETAs for route waypoints are displayed.
	Holding pattern: active (M), modified (W), inactive (C)	MAP, MAP CTR, PLN	A holding pattern appears when in the flight plan. The holding pattern appears as a fixed size if the selected range is greater than 80 NM. A scaled representation of the holding pattern is displayed when the selected range is 80 NM or less and the airplane is within 3 minutes of the holding fix.
	Altitude range arc (G)	MAP, MAP CTR	Based on vertical speed and groundspeed, indicates the approximate map position where the MCP altitude will be reached.

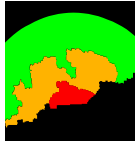
737 Flight Crew Operations Manual



SYMBOL	NAME	MODE	REMARKS
	Altitude profile point and identifier (G)	MAP, MAP CTR, PLN	<p>Indicates the approximate map position of the FMC-calculated T/C (top-of-climb), T/D (top-of-descent), S/C (step climb), and E/D (end of descent) points.</p> <p>Indicates intermediate T/D points for level flight path segments during descent. Level flight path segment altitude is displayed.</p> <p>Indicates the beginning of a deceleration segment resulting from deceleration to a holding pattern, a waypoint speed restriction or flaps up maneuvering speed.</p> <p>Indicates airport speed restriction deceleration point (no identifier).</p>
	Procedure turn: active (M), modified (W), inactive (C)	MAP, MAP CTR, PLN	<p>A procedure turn appears when in the flight plan.</p> <p>The procedure turn appears as a fixed size if the selected range is greater than 80 NM.</p> <p>A scaled representation of the procedure turn is displayed when the selected range is 80 NM or less and the airplane is within 3 minutes of the procedure turn.</p>
	Airport and runway (W)	MAP, MAP CTR, PLN	Displayed when selected as the origin or destination and selected range is 80, 160, 320, or 640 NM.
	Airport (C)	MAP, MAP CTR, PLN	<p>Displayed if the EFIS control panel ARPT map switch is selected on.</p> <p>Origin and destination airports are always displayed, regardless of map switch selection.</p>

SYMBOL	NAME	MODE	REMARKS
	Airport and runway (W)	MAP, MAP CTR, PLN	Displayed when selected as the origin or destination and selected range is 5, 10, 20, or 40 NM. Dashed runway centerlines extend 14.2 NM.
	Selected reference point and bearing distance information (G)	MAP, MAP CTR, PLN	Displays the reference point selected on the CDU FIX page. Bearing and/or distance from the fix are displayed with dashes (G).
	GPS position (W)	MAP, MAP CTR	When the EFIS POS map switch is selected on, indicates GPS position relative to FMC position.
	ADIRU position (W)	MAP, MAP CTR	When the EFIS control panel POS map switch is selected on, the star indicates ADIRU position relative to FMC position.
	Weather radar returns (R, A, G, M)	MAP, MAP CTR, VOR, APP	The most intense areas are displayed in red, lesser intensity in amber, and lowest intensity green. Turbulence is displayed in magenta.
	Selected map options (C)	MAP, MAP CTR, PLN	Displays EFIS control panel selected map options.
	MAP source annunciation (G)	MAP, MAP CTR, PLN	Displays source of FMC data used by CDS for data presentation.
	Range arcs (W)	MAP, VOR, APP	Displayed in APP and VOR modes when the WXR map, TERR map or TCAS TFC switches are selected. Displayed full time in MAP mode.
	Weather radar annunciations: Mode (C), Tilt (C), Gain (C)	MAP, MAP CTR, VOR, APP	Annunciations vary with option selected

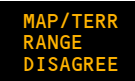





Look-Ahead Terrain



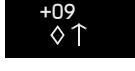

SYMBOL	NAME	MODE	REMARKS
	Terrain display (R, A, G, M)	MAP, MAP CTR, VOR, APP	Displays terrain data from the GPWS terrain data base. Color and density vary based on terrain height vs. airplane altitude. Refer to Chapter 15, Warning Systems.
	Terrain mode annunciation (C)	MAP, MAP CTR, VOR, APP	Terrain display enabled (manual or automatic display).
	Terrain test mode annunciation (C)	All	GPWS operating in self-test mode.
	Terrain annunciation (R, A)	All	Look-ahead terrain caution alert active (A), look-ahead terrain warning alert active (R).
	Terrain status annunciations (A)	All	Look-ahead terrain alerting and display have failed.
	Terrain status annunciations (A)	All	Look-ahead terrain alerting and display unavailable due to position uncertainty.
	Terrain status annunciations (A)	All	GPWS terrain inhibit switch in TERR INHIBIT position.
	Terrain range status annunciations (A)	MAP, MAP CTR, VOR, APP	Terrain output range disagrees with selected EFIS control panel range.
	Terrain range status annunciations (A)	MAP, MAP CTR	Terrain output range and map display output range disagree with selected EFIS control panel range.

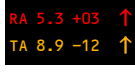
Predictive Windshear

SYMBOL	NAME	MODE	REMARKS
	Predictive windshear symbol (R, B, A)	MAP, MAP CTR, VOR, APP	Displays windshear location and approximate geometric size (width and depth). Amber radials extend from predictive windshear symbol to help identify location of windshear event.
	Windshear annunciation (R, A)	All	Predictive windshear caution active (A). Predictive windshear warning active (R).
	Predictive windshear status annunciation (A)	All	Predictive windshear alerting and display have failed.

TCAS

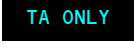
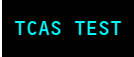
SYMBOL	NAME	MODE	REMARKS
	TCAS resolution advisory (RA), relative altitude (R)	MAP, MAP CTR, VOR, APP	These symbols are displayed only when the EFIS control panel traffic (TFC) switch is selected on. Refer to Chapter 15, Warning Systems. The arrow indicates traffic climbing or descending at a rate ≥ 500 fpm. At rates < 500 fpm, the arrow is not displayed. For relative altitude symbols, the number and associated signs indicate altitude of traffic in hundreds of feet relative to the airplane. For absolute altitude symbols, the number indicates altitude of traffic in thousands and hundreds of feet. For both relative and absolute altitude, the number is below the traffic symbol when the traffic is below, and above the traffic symbol when the traffic is above the airplane. Absence of the number implies altitude unknown.
	TCAS traffic advisory (TA), relative altitude (A)		
	TCAS proximate traffic, relative altitude (W)		
	TCAS other traffic, relative altitude (W)		
	TCAS TA, absolute altitude (A)		
	TCAS no bearing message (RA-R, TA-A)	MAP, MAP CTR, VOR, APP	Message provides traffic type, range in NM, altitude and vertical direction. TFC must be selected on.
	TCAS traffic alert message (RA-R, TA-A)	All	Displayed whenever a TCAS RA or TA is active. EFIS control panel TFC switch does not have to be selected on.

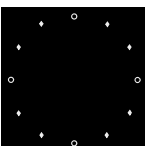
SYMBOL	NAME	MODE	REMARKS
	TCAS off scale message (RA-R, TA-A)	MAP, MAP CTR, VOR, APP	Displayed whenever RA or TA traffic is outside the traffic area covered by the ND range. Displayed only if the EFIS control panel TFC switch is selected on.
	TCAS mode (C)	MAP, MAP CTR, VOR, APP	Indicates the ND TCAS display is active; the EFIS control panel TFC switch is selected on.
	TCAS mode (C)	All	Indicates TCAS computer is not computing RAs. Displayed whether the EFIS control panel TFC switch is selected on or off.
	TCAS mode (C)	All	Indicates TCAS is operating in the test mode. Displayed whether EFIS control panel TFC switch is selected on or off.
	TCAS mode (A)	All	Displayed when the TCAS/ATC mode switch is not in TA ONLY or TA/RA, if traffic is selected. Not displayed if TCAS is failed.
	TCAS mode (A)	All	Indicates TCAS failure, if traffic is selected.
	Range Ring (W)	MAP, MAP CTR, VOR, APP	Displayed when TFC selected on EFIS Control Panel. Shows 3 NM range ring oriented to aircraft heading. Displayed at ranges of 80 NM or less.



Controls and Indicators	11.10.1
Flight Management System	11.10.1
Control Display Unit (CDU)	11.10.1
Function and Execute Keys	11.10.2
Alpha/Numeric and Miscellaneous Keys	11.10.3
CDU Page Components	11.10.4
CDU Page Color	11.10.5
FMC Source Select Switch	11.10.8
FMC Alert Light	11.10.8
Global Positioning System (GPS) Light	11.10.9
Inertial System	11.10.10
IRS Display Unit (ISDU)	11.10.10
IRS Mode Selector Unit	11.10.12
IRS Transfer Switch	11.10.14
Radio Navigation Systems	11.10.14
Automatic Direction Finding (ADF) Control	11.10.14
Marker Beacon Annunciations	11.10.16
VHF Navigation Control	11.10.17
VHF NAV Transfer Switch	11.10.18
Transponder Panel	11.10.18
Weather Radar Panel	11.10.20
Navigation Systems Description	11.20.1
Introduction	11.20.1
Flight Management System	11.20.1
Global Positioning System (GPS)	11.20.2
GPS Displays	11.20.2
GPS Data	11.20.2
GPS System Schematic	11.20.3



Inertial System	11.20.4
Inertial Reference System	11.20.4
Inertial System Display Unit (ISDU)	11.20.6
Mode Select Unit (MSU)	11.20.6
IRS Transfer Switch	11.20.6
IRS Instrument Transfer Switch Schematic	11.20.7
Radio Navigation Systems	11.20.7
Automatic Direction Finding (ADF)	11.20.7
Distance Measuring Equipment (DME)	11.20.8
Instrument Landing System (ILS)	11.20.8
Navaid Identifier Decoding	11.20.8
Marker Beacon	11.20.9
Very High Frequency Omni Range (VOR)	11.20.9
VHF NAV Transfer Switch	11.20.9
ATC Transponder	11.20.9
Weather Radar	11.20.10
Flight Management System Description	11.30.1
Introduction	11.30.1
Flight Management Computer (FMC)	11.30.1
Control Display Units (CDUs)	11.30.3
Flight Management System Operation	11.31.1
Introduction	11.31.1
Preflight	11.31.1
Takeoff	11.31.2
Climb	11.31.2
Cruise	11.31.2
Descent	11.31.2
Approach	11.31.2
Flight Complete	11.31.2
FMC and CDU Terminology	11.31.2
Maintenance Index Page	11.31.4



737 Flight Crew Operations Manual

Navigation Position	11.31.4
FMC Position Update	11.31.4
Navigation Performance	11.31.6
Lateral Navigation (LNAV)	11.31.9
Waypoints	11.31.9
Navigation Displays	11.31.17
Vertical Navigation (VNAV)	11.31.17
Speed/Altitude Restrictions	11.31.17
Takeoff and Climb	11.31.18
Cruise	11.31.19
Descent	11.31.20
Early Descent	11.31.28
Approach	11.31.29
Go-Around	11.31.30
VNAV Cruise (Engine Out Above Eng Out Max Alt)	11.31.31
Required Time of Arrival (RTA)	11.31.32
Data Entry Rules	11.31.32
Altitude Entry	11.31.32
Airspeed Entry	11.31.33
Data Pairs	11.31.34
Bearing Entry	11.31.34
Plus/Minus Signs	11.31.34
Flight Management Computer	11.32.1
FMC Databases	11.32.1
Thrust Management	11.32.2
Reduced Thrust Takeoff	11.32.2
Derated Thrust Climb	11.32.3
Fuel Monitoring	11.32.4
Loss of FMC Electrical Power	11.32.4
FMC Failure	11.32.5
Single FMC Failure	11.32.5
Dual FMC Failure	11.32.5

Company Data Link	11.33.1
Company Data Link	11.33.1
Data Link	11.33.2
Manual Downlinks	11.33.2
Automatic Downlinks	11.33.3
Uplinks	11.33.4
Long Delete Function	11.33.4
Requests	11.33.5
Request Status	11.33.6
FMC Data Link Uplinks (Accept/Reject)	11.33.7
FMC Data Link Uplinks (Load/Activate/Exec)	11.33.8
FMC Data Link Uplinks (Load/Exec-Erase)	11.33.8
FMC Data Link Uplinks (Request)	11.33.10
FMC Data Link Uplinks (Automatic)	11.33.10
Data Link Management	11.33.11
CDU Data Link Status Displays	11.33.11
FMC Preflight	11.40.1
Introduction	11.40.1
Preflight Page Sequence	11.40.1
Minimum Preflight Sequence	11.40.2
Supplementary Pages	11.40.2
Preflight Pages	11.40.4
Initialization/Reference Index Page	11.40.4
Identification Page	11.40.6
Position Initialization Page 1/3	11.40.8
Position Reference Page 2/3	11.40.11
Route Page 1/X	11.40.13
Additional Route Page Prompts for an Activated Route	11.40.18
Departure/Arrival Index Page	11.40.19
Departures Page	11.40.21
Performance Initialization Page	11.40.23
Performance Limits Page	11.40.26



737 Flight Crew Operations Manual

N1 LIMIT Page - Preflight	11.40.28
Takeoff Reference Page 1/2	11.40.31
Takeoff Reference Page 2/2	11.40.38
Menu Page	11.40.42
FMC Takeoff and Climb	11.41.1
Introduction	11.41.1
Takeoff Phase	11.41.1
Climb Phase	11.41.2
Climb Page	11.41.3
RTA Climb Page	11.41.7
RTE LEGS Page	11.41.8
Progress Page 1/X	11.41.12
Progress Page 2/4	11.41.14
RTA Progress Page 3/4	11.41.16
RNP Progress Page 4/4	11.41.21
N1 Limit Page	11.41.25
Engine Out Climb	11.41.27
Engine Out Climb Page	11.41.27
Air Turnback	11.41.29
Arrivals Page	11.41.29
FMC Cruise	11.42.1
Introduction	11.42.1
LNAV Modifications	11.42.1
RTE LEGS Page Modifications	11.42.2
Adding Waypoints	11.42.2
Deleting Waypoints	11.42.4
Resequencing Waypoints	11.42.5
Leg Bypass	11.42.6
Removing Discontinuities	11.42.7
Direct To and Intercept Course	11.42.8
Select Desired Waypoint Page	11.42.9
Lateral Offset	11.42.11



Progress Page	11.42.13
VNAV Modifications	11.42.14
Cruise Page	11.42.14
RTA Cruise	11.42.16
Cruise with Step Climb	11.42.17
Cruise Climb	11.42.18
RTA Cruise Climb	11.42.19
Cruise Descent	11.42.20
RTA Cruise Descent	11.42.21
Engine Out Cruise	11.42.22
Early Descent	11.42.23
Route and Waypoint Data	11.42.24
Route Data (RTE DATA) Page	11.42.24
Position Shift Page 3/3	11.42.26
Inflight Position Update	11.42.28
Navigation Data	11.42.29
Reference Navigation Data (REF NAV DATA) Page	11.42.29
Waypoint Data Display	11.42.31
Navigation Aid Data Display	11.42.32
Airport Data Display	11.42.33
Runway Data Display	11.42.34
Navigation Summary (NAV SUMMARY)	11.42.35
Supplemental Nav Data	11.42.36
Navigation Status Display	11.42.37
Navigation Options (NAV OPTIONS)	11.42.39
Fix Information Page	11.42.40
FMC Descent and Approach	11.43.1
Introduction	11.43.1
Early Descent	11.43.1
Descent	11.43.1
Descent Page (During Cruise)	11.43.1
Descent Page (During Descent)	11.43.4
RTA Descent Page	11.43.6



737 Flight Crew Operations Manual

Descent Forecast Page	11.43.8
Engine Out Descent	11.43.9
Approach	11.43.10
Arrivals Page – IFR Approaches	11.43.10
Approach Reference Page	11.43.18
Holding	11.43.22
HOLD Page	11.43.22
RTE LEGS HOLD AT (Fix in Route)	11.43.29
RTE LEGS HOLD AT (Fix not in Route)	11.43.31
FMC Messages	11.60.1
Introduction	11.60.1
FMC Alerting Messages	11.60.2
FMC Entry Error Messages	11.60.11
FMC Advisory Messages	11.60.13
FMC Data Link Messages	11.60.18
FMC Data Link Alerting Messages	11.60.18
FMC Data Link Advisory Messages	11.60.23



Intentionally
Blank

Flight Management System

Control Display Unit (CDU)

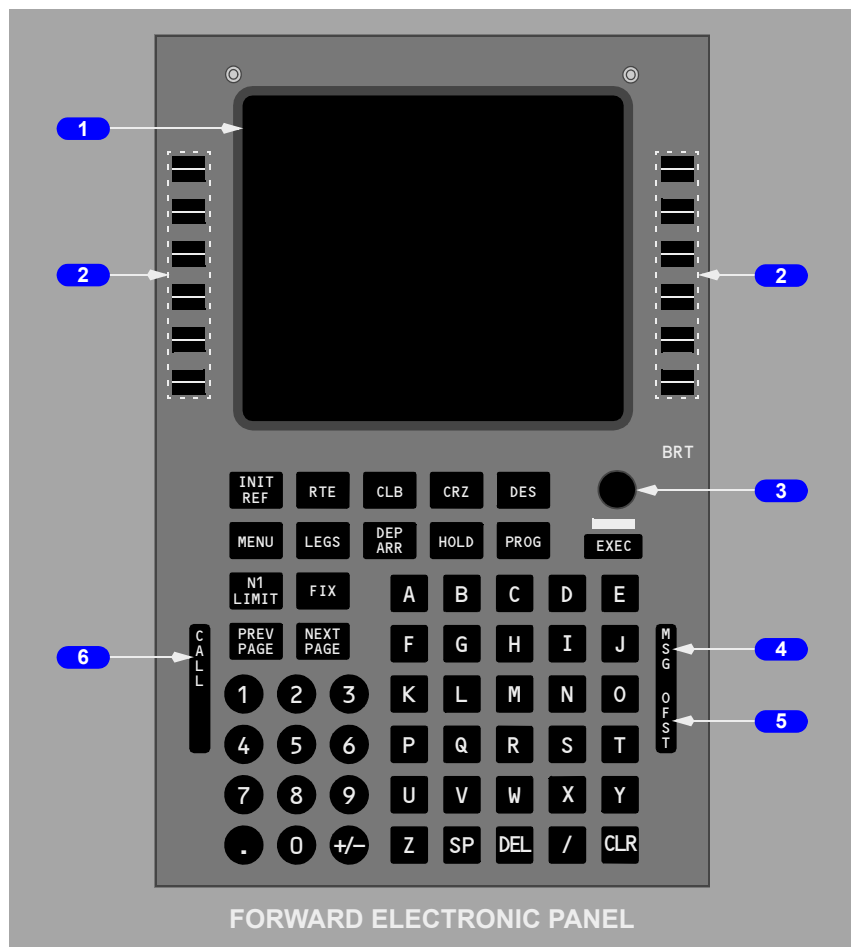

1 Control Display Unit (CDU) Display

Shows FMS data pages.

2 Line Select Keys

Push –

- moves data from scratchpad to selected line
- moves data from selected line to scratchpad
- selects page, procedure, or performance mode as applicable
- deletes data from selected line when DELETE is shown in scratchpad.

3 Brightness Control

Rotate – controls display brightness.

4 Message (MSG) Light

Illuminated (white) – scratchpad message is shown.

5 Offset (OFST) Light

Illuminated (white) – LNAV gives guidance for lateral route offset.

6 CALL Light

Illuminated (white) – a subsystem other than the FMC is requesting control of the CDU.

Function and Execute Keys

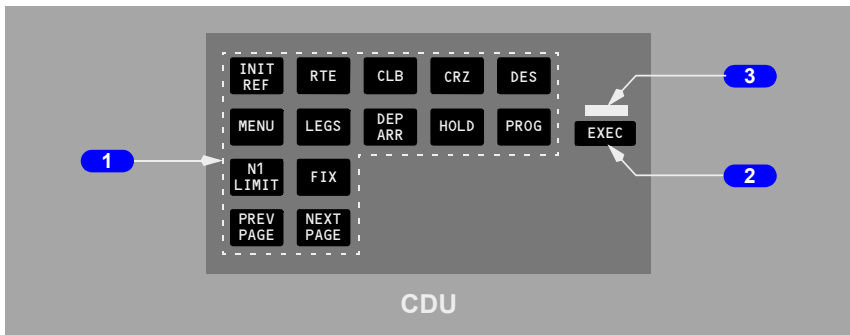

1 CDU Function Keys

Push –

- INIT REF – shows page for data initialization or for reference data
- RTE – shows page to input or change origin, destination, or route
- CLB – shows page to view or change climb data
- CRZ – shows page to view or change cruise data
- DES – shows page to view or change descent data
- MENU – shows page to choose subsystems controlled by CDU

737 Flight Crew Operations Manual

- LEGS –
 - shows page to evaluate or modify lateral and vertical data
 - shows page to control PLAN mode display
- DEP ARR – shows page to input or change departure and arrival procedures
- HOLD – shows page to create holding patterns and show holding pattern data
- PROG – shows page to view dynamic flight and navigation data, including waypoint and destination ETAs, fuel remaining, and arrival estimates
- N1 LIMIT – shows page to view or change N1 thrust limits
- FIX – shows page to create reference points on map display
- PREV PAGE – shows previous page of related pages (for example, LEGS pages)
- NEXT PAGE – shows next page of related pages.

2 Execute (EXEC) Key

Push –

- makes data modification(s) active
- extinguishes execute light.

3 Execute Light

Illuminated (white) – active data is modified but not executed.

Alpha/Numeric and Miscellaneous Keys

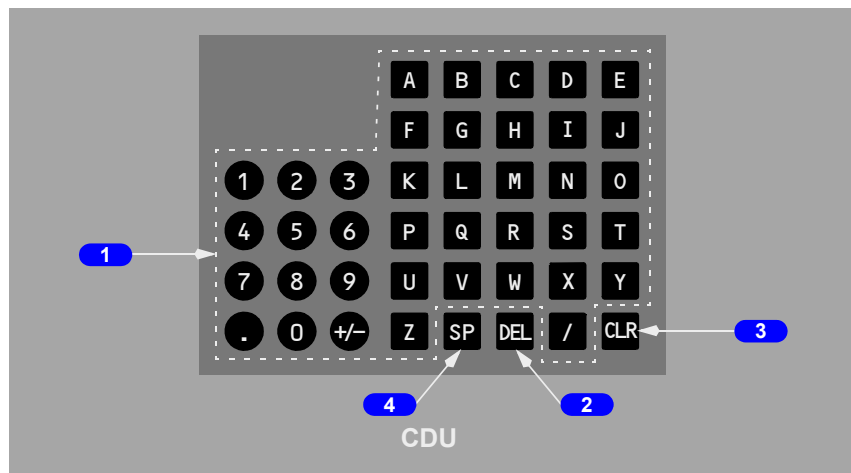

1 Alpha/Numeric Keys

Push –

- puts selected character in scratchpad
- Slash (/) key – puts “/” in scratchpad
- Plus Minus (+/-) key – first push puts “-” in scratchpad. Subsequent pushes alternate between “+” and “-”.

2 Delete (DEL) Key

Push – puts DELETE in scratchpad.

3 Clear (CLR) Key

Push –

- clears the last scratchpad character
- clears scratchpad message.

Push and hold – clears all scratchpad data.

4 Space (SP) Key

Push – puts space in scratchpad.

CDU Page Components



1 Page Title

Subject or name of data shown on page.

ACT (active) or MOD (modified) shows whether page contains active or modified data.

737 Flight Crew Operations Manual

2 Line Title

Title of data on line below.

3 Line

Shows –

- prompts
- selections
- options
- data.

4 Scratchpad

Shows messages, alpha–numeric entries or line selected data.

5 Page Number

Left number is page number. Right number is total number of related pages.

6 Boxes

Data input is mandatory.

7 Dashes

Data input is optional. The data is not mandatory.

8 Prompts

Show pages, select modes, and control displays. Caret “<” or “>” is before or after prompt.

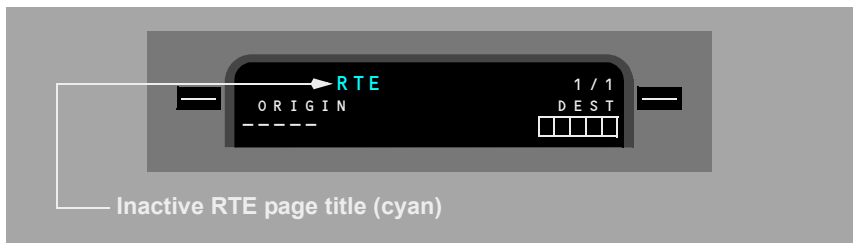
CDU Page Color

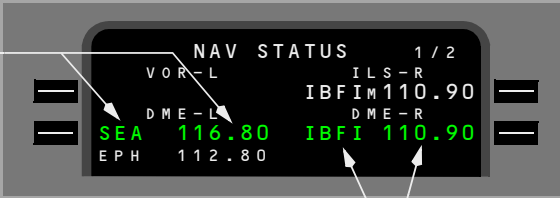

Nav aids being used in navigation solution (green)

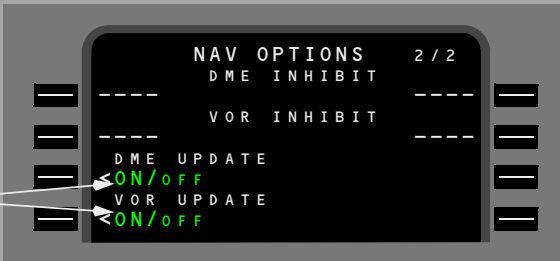

Active state (green)

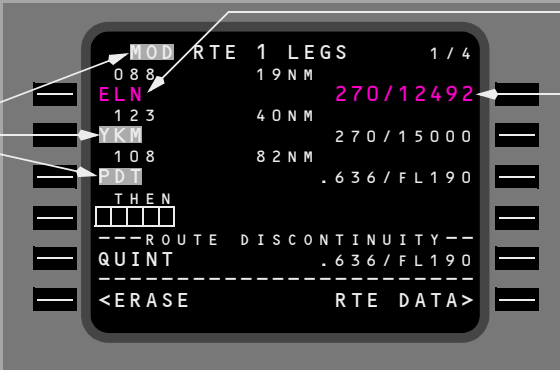

Flight plan modification not yet executed (shaded white)

Active airspeed, altitude, waypoint name (magenta)

737 Flight Crew Operations Manual

Color is used as follows:

- black – background color of page
- cyan –
 - inactive RTE, RTE LEGS and RTE HOLD page titles
- green –
 - actively tuned VOR, ILS, or DME data (frequency, station ID, course)
 - active state of two–position and three–position selectors.
- magenta – data used by FMC for lateral and vertical flight commands
 - active waypoint
 - active airspeed
 - active altitude
 - holding pattern inbound course, direction of turn, and leg time or leg distance
- shaded white –
 - modifications
 - MOD precedes page titles of modified pages
- white – most data

FMC Source Select Switch

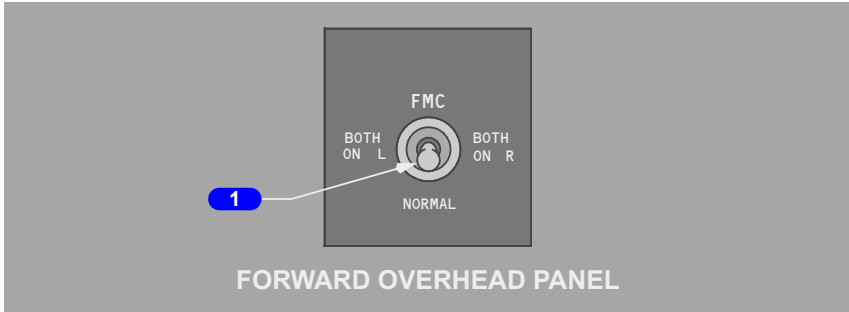

1 FMC Source Select Switch

BOTH ON L –

- selects left FMC for all FMC operations
- right map will annunciate “FMC L.”

NORMAL –

- left FMC controls CDUs and provides input to the autothrottle system
- right FMC operates in synchronization with left FMC
- maps display composite information from both FMCs

BOTH ON R –

- selects right FMC for all FMC operations
- left map will annunciate “FMC R.”

Note: Moving the source select switch will cause LNAV and VNAV to disengage.

FMC Alert Light

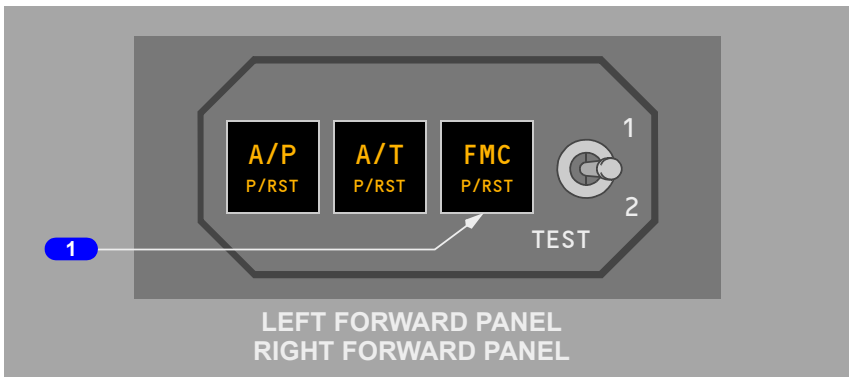

1 FMC Alert Light

Illuminated (amber) –

- an alerting message exists for both CDUs, or
- test switch is in position 1 or 2.

Push – both pilots’ FMC alert lights extinguish.

Global Positioning System (GPS) Light

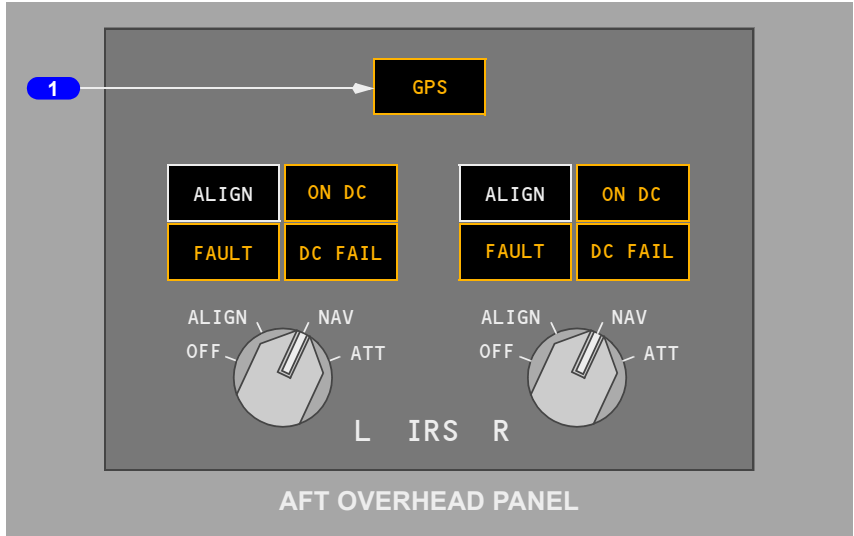

1 Global Positioning System (GPS) Light

Illuminated (amber) –

- indicates failure of both GPS sensor units
- indicates failure of a single GPS sensor unit when either system annunciator panel is pushed to initiate a recall
- with single GPS sensor failure, light extinguishes when the system recall is reset.

Inertial System

IRS Display Unit (ISDU)

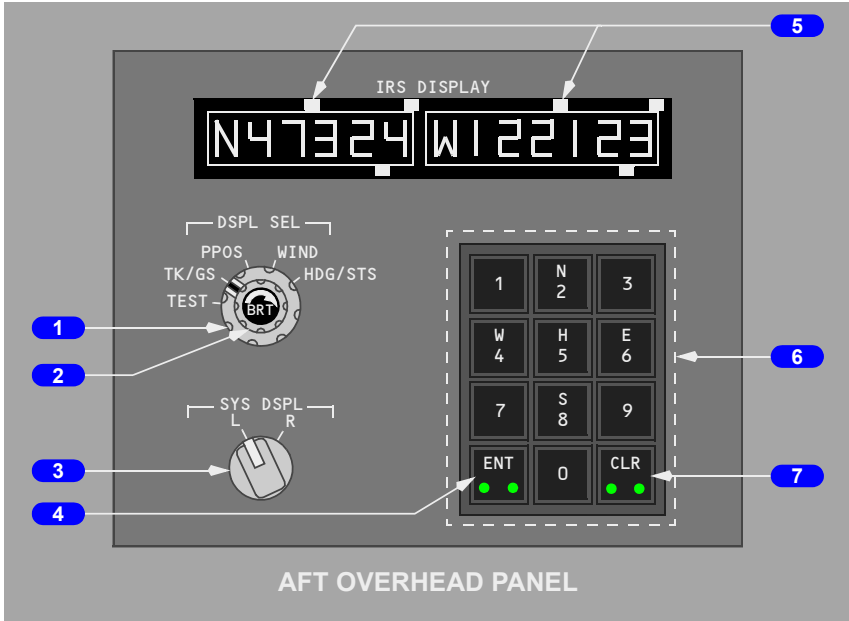

1 Display Selector (DSPL SEL)

TEST (spring-loaded to TK/GS) –

- all lights in data displays and on the mode selector unit momentarily illuminate, followed by a 10 second self-test
- use only during alignment.

TK/GS –

- left window displays true track (course)
- right window displays present ground speed (knots).

PPOS –

- left window displays present latitude
- right window displays present longitude.

WIND –

- left window displays present inflight true wind direction
- right window displays present inflight wind speed (knots).

737 Flight Crew Operations Manual

HDG/STS –

- left window displays present true heading
- right window displays any applicable maintenance status codes
- during alignment, right window displays minutes remaining until alignment is complete. For alignments greater than 15 minutes, the window displays 15 until the time remaining reaches 14 minutes. The display then counts down in one minute intervals.

2 Brightness (BRT) Control

Rotate – adjusts brightness of the data displays.

3 System Display (SYS DSPL) Selector

L – selects left IRS for the data displays.

R – selects right IRS for the data displays.

4 Enter (ENT) Key

Illuminated (white) – N, S, E, W, or H entries are being keyed.

Push – keyed data is entered into IRS following completion of valid self-test for reasonableness.

5 Data Displays

Two windows display data for the IRS selected with the system display selector

- type of data displayed is normally determined by the display selector
- keyboard entry of present position or magnetic heading overrides the selected display
- last digit of each window is for a decimal place (tenths).

6 Keyboard

Push –

- alpha keys:
 - data displays are controlled by the keyboard when the N, S, E, W (latitude/longitude) or H (heading) keys are pushed
 - pushing an alpha key arms the keyboard for numeric entries.
- numeric keys:
 - permit manual entry of present position when ALIGN light is illuminated
 - permit manual entry of magnetic heading when either mode selector is in ATT.

7 Clear (CLR) Key

Illuminated (white) – an ENT attempt has failed (entry not accepted by IRS).

Push – clears data display of any data not yet entered or accepted. If illuminated, cue lights extinguish.

IRS Mode Selector Unit

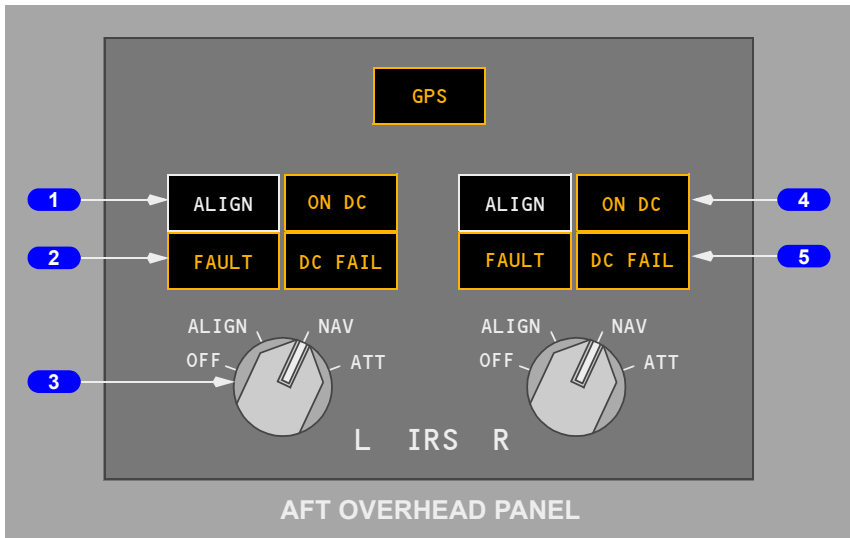

1 ALIGN Light

Illuminated (white) –

- steady – the related IRS is operating in the ALIGN mode, the initial ATT mode, or the shutdown cycle
- flashing – alignment cannot be completed due to IRS detection of:
 - significant difference between previous and entered positions or an unreasonable present position entry
 - no present position entry.

Extinguished –

- IRS not in ALIGN mode
- with mode selector in NAV, alignment is complete, and all IRS information is available
- with mode selector in ATT, attitude information is available. Heading information is available following entry of initial magnetic heading.

2 FAULT Light

Illuminated (amber) – a system fault affecting the related IRS ATT and/or NAV modes has been detected.

3 Inertial Reference System (IRS) Mode Selector

OFF –

- alignment is lost
- all electrical power is removed from the system after a 30 second shutdown cycle.

ALIGN –

- rotating the selector from OFF to ALIGN initiates the alignment cycle
- rotating the selector from NAV to ALIGN automatically updates alignment and zeroes ground speed error.

NAV (detented position) –

- system enters the NAV mode after completion of the alignment cycle and entry of present position
- in NAV mode, all IRS information is available to airplane systems for normal operations.

ATT – provides only attitude and heading information:

- attitude information is invalid (attitude flag in view) until ALIGN light is extinguished
- heading information is invalid (heading flags in view) until the actual magnetic heading is manually entered and the ALIGN light is extinguished
- position and ground speed information is not available until the IRS is aligned on the ground
- the selector must be cycled to OFF before reselecting ALIGN or NAV.

4 ON DC Light

Illuminated (amber) –

- the related IRS is operating on DC power from the switched hot battery bus (AC power not normal)
- if on the ground, the ground-call horn in the nose wheel well sounds, providing an alert that a battery drain condition exists
- momentary illumination is normal during alignment self-test.

5 DC FAIL Light

Illuminated (amber) –

- DC power for the related IRS is not normal
- if the other lights are extinguished, the IRS is operating normally on AC power.

IRS Transfer Switch

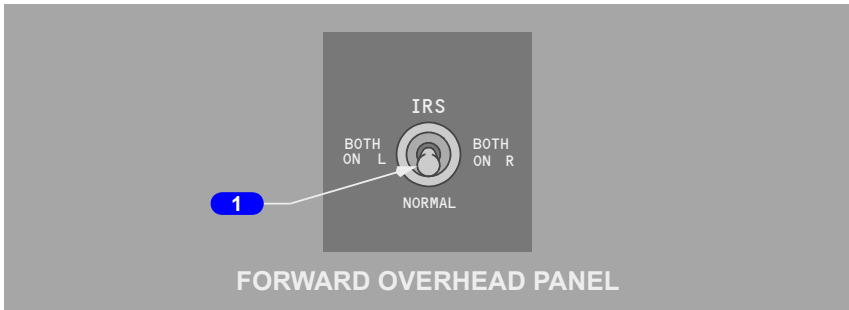

1 Inertial Reference System (IRS) Transfer Switch

BOTH ON L – switches the flight instruments attitude and heading source to left IRS.

NORMAL – flight instruments attitude and heading source is from default IRS.

BOTH ON R – switches the flight instruments attitude and heading source to right IRS.

Radio Navigation Systems

Automatic Direction Finding (ADF) Control

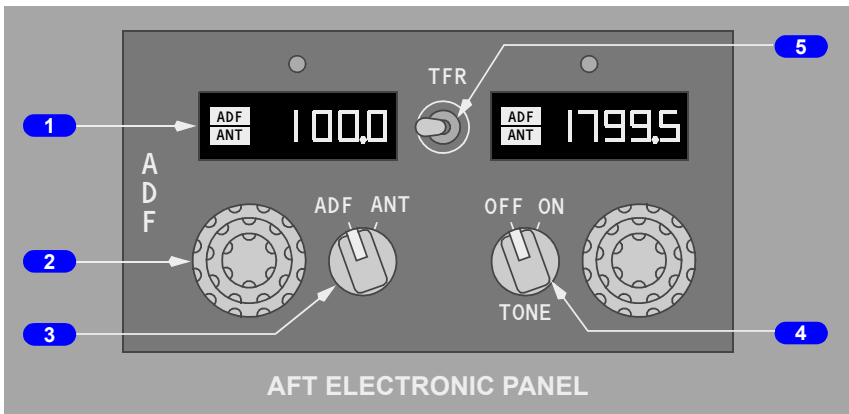

1 Frequency Indicator

Shows the frequency selected with the related frequency selector.

Shows if the system is in the ADF or antenna (ANT) mode.

2 Frequency Selector

Rotate –

- outer knob sets the hundreds number
- middle knob sets the tens number
- inner knob sets the tenths and ones number.

3 Mode Selector

ADF –

- audio reception possible
- ADF bearing sent to the DUs and the standby radio magnetic indicator.

ANT –

- audio reception optimized
- no ADF bearing data available.

4 TONE Switch

OFF – disables tones.

ON – adds tone to selected ADF receiver audio.

5 Transfer (TFR) Switch

Selects ADF for display.

Marker Beacon Annunciations

YA371, YA372, YC201

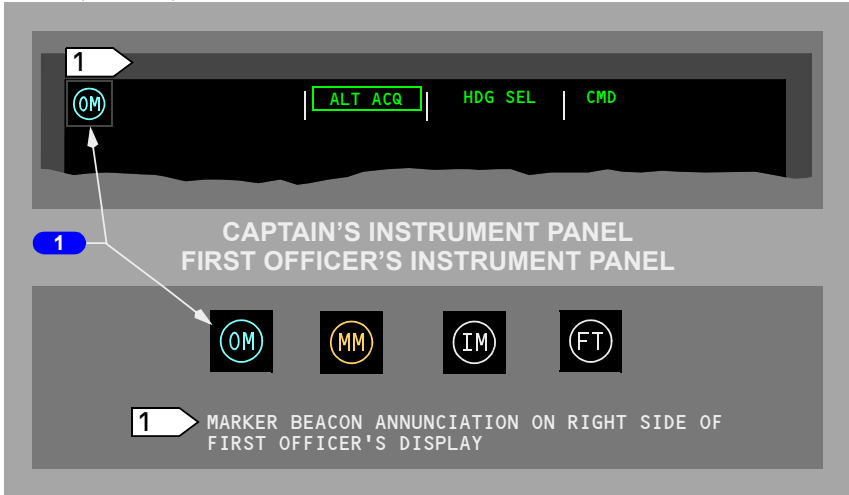

YA373 - YA377, YC202 - YE326

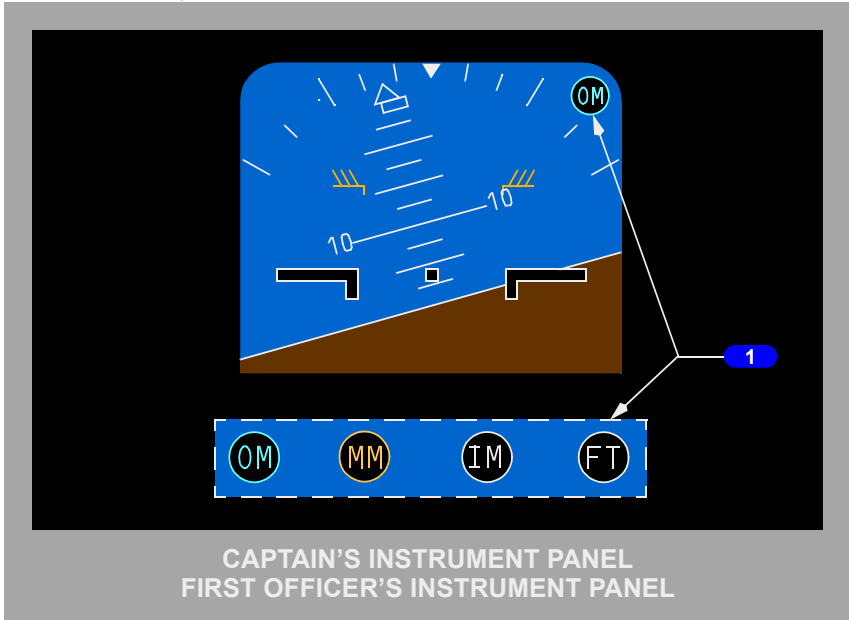

1 Marker Beacon Lights

OM (cyan) – illuminates over an outer marker beacon.

MM (amber) – illuminates over a middle marker beacon.

737 Flight Crew Operations Manual

IM (white) – illuminates over an inner marker beacon.

FT (white) – illuminates during self test.

VHF Navigation Control

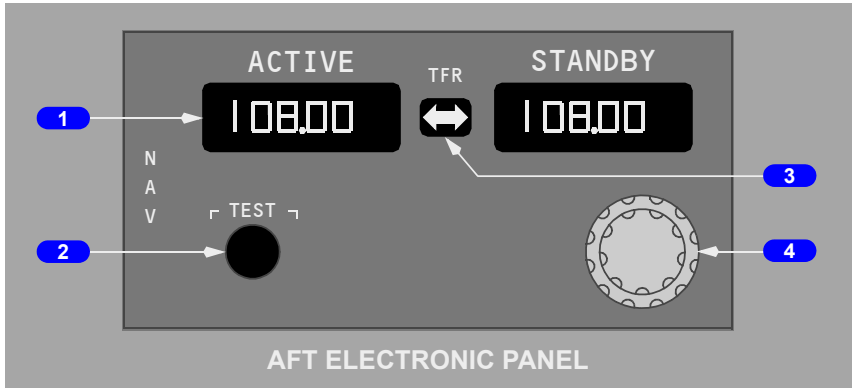

1 Frequency Indicator

Indicates the frequency selected by the frequency selector

- tuned frequency displayed in STANDBY display
- TFR switch moves STANDBY frequency to ACTIVE frequency.

2 TEST Switch

With a VOR frequency tuned and a course of 000 selected:

- shows VOR fail flag
- deviation bar biases out of view and then returns to centered position
- bearing pointer slews to 180 degrees
- DME displays:
 - DME fail flag
 - dashes
 - normal DME distance.

With ILS frequency tuned and a course within 90 degrees of airplane heading:

- pointers disappear and LOC and G/S flags appear momentarily
- pointers appear and display one dot up and one dot left
- pointers then display one dot low and one dot right
- pointers then return to normal display
- DME displays:
 - DME fail flag
 - dashes
 - normal DME distance.

3 Transfer (TFR) Switch

TFR – STANDBY frequency moved to ACTIVE frequency; ACTIVE frequency moved to STANDBY frequency.

4 Frequency Selector

Rotate – manually selects the standby frequency.

VHF NAV Transfer Switch

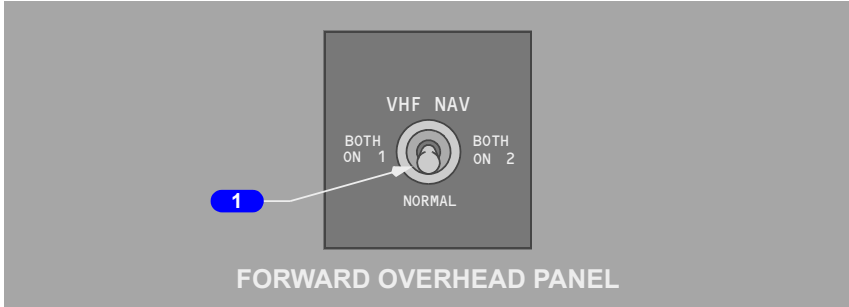

1 VHF NAV Transfer Switch

BOTH ON 1 – switches the VHF navigation source to VHF NAV receiver No. 1.

NORMAL – VHF navigation source is from default VHF NAV receiver.

BOTH ON 2 – switches the VHF navigation source to VHF NAV receiver No. 2.

Transponder Panel

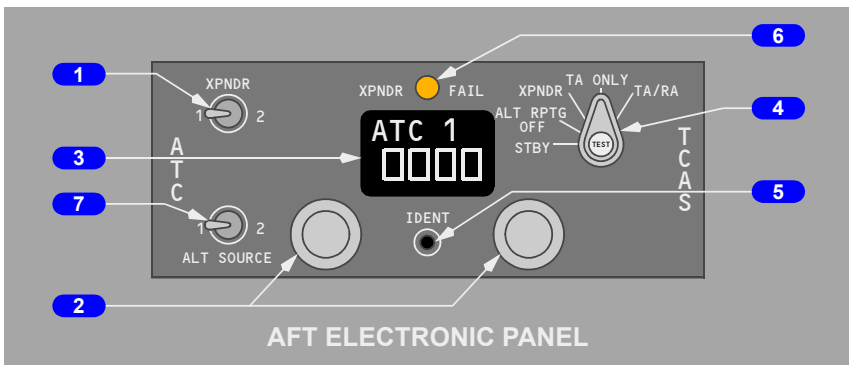

1 Transponder (XPNDR) Selector

1 – selects transponder No. 1.

2 – selects transponder No. 2.

2 Air Traffic Control (ATC) Code Selector

Rotate – sets transponder code in transponder.

3 Air Traffic Control (ATC) Code Indicator

Shows transponder code.

Shows operating transponder (1 or 2).

4 Transponder Mode Selector

TEST – starts ATC transponder functional test.

STBY (standby) – does not transmit.

ALT RPTG (altitude reporting) OFF – transponder operates without altitude reporting.

XPNDR (transponder) – transponder operates with altitude reporting.

TA (traffic advisory) ONLY, and TA/RA (resolution advisory) – Refer to Chapter 15, Warning Systems.

5 Identification (IDENT) Switch

Push – transmits an identification signal.

6 Transponder (XPNDR) FAIL Light

Illuminated (amber) – indicates transponder malfunction.

7 Altitude (ALT) SOURCE Selector

1 – enables altitude reporting from air data computer No. 1.

2 – enables altitude reporting from air data computer No. 2.

Weather Radar Panel

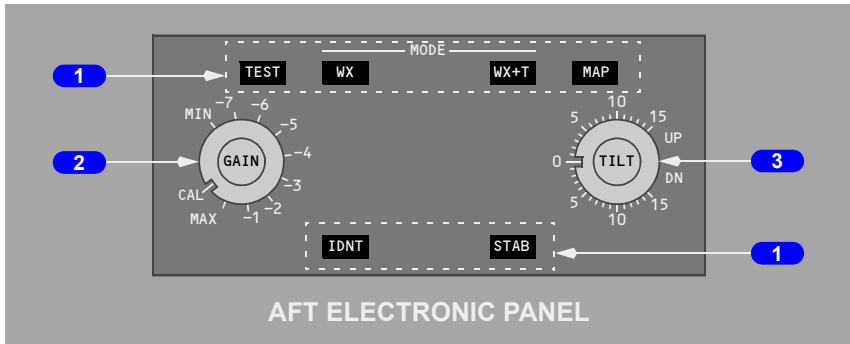

1 Mode Switches

Push – selects mode.

TEST –

- tests weather radar system operation without transmitting
- shows test pattern and any fault messages on navigation display MAP, center MAP, VOR, and APP modes, with WXR selected.

Note: If the airplane is on the ground and the thrust levers are not advanced for takeoff, WXR tests the predictive windshear system (PWS) indications. These include PWS caution, PWS FAIL, and PWS warning. Deactivating WXR on the EFIS control panel will not discontinue the test and can result in automatic WXR activation on both pilot displays. The PWS test lasts approximately 15 seconds.

WX (weather) – shows weather radar returns at selected gain level.

WX+T (turbulence) –

- shows weather radar returns
- shows turbulence within 50 miles.

Note: Turbulence detection requires presence of detectable precipitation. Clear air turbulence cannot be detected by radar.

MAP – shows ground returns.

IDNT – suppresses ground return in WX and WX+T modes.

STAB – antenna tilt automatically adjusts to correct for airplane attitude changes.

2 GAIN Control

Rotate – sets receiver sensitivity in WX, WX+T, and MAP modes.



737 Flight Crew Operations Manual

CAL (calibrated) – presets an optimum receiver sensitivity for best weather radar display.

3 TILT Control

Rotate clockwise – radar antenna tilts up to selected degrees above horizon.

Rotate counterclockwise – radar antenna tilts down to selected degrees below horizon.



Intentionally
Blank



Introduction

Navigation systems include the flight management system (FMS); global positioning system (GPS); air data inertial reference system (ADIRS); radio navigation systems (ADF, DME, ILS, marker beacons, and VOR); transponder; and weather radar.

Flight Management System

The flight management system (FMS) is comprised of the following components:

- flight management computer system (FMCS)
- autopilot/flight director system (AFDS)
- autothrottle (A/T)
- inertial reference systems (IRS)
- global positioning system (GPS).

Each of these components is an independent system, and each can be used independently or in various combinations. The term FMS refers to the concept of joining these independent components together into one integrated system which provides continuous automatic navigation, guidance, and performance management.

The integrated FMS provides centralized flight deck control of the airplane's flight path and performance parameters. The flight management computer, or FMC, is the heart of the system, performing navigational and performance computations and providing control and guidance commands.

The primary flight deck controls are the AFDS MCP, two control display units (CDU's), two electronic flight instrument system (EFIS) control panels, and an FMC source selector switch. The primary displays are the CDUs, outboard display units, inboard display units, and upper display unit.

The FMC uses crew entered flight plan information, airplane systems data, and data from the FMC navigation database and performance database to calculate airplane present position, and pitch, roll, and thrust commands required to fly an optimum flight profile. The FMC sends these commands to the autothrottle, autopilot, and flight director. Map and route information are sent to the respective pilot's navigation displays. The EFIS control panels are used to select the desired information for navigation display. The mode control panel is used to select the autothrottle, autopilot, and flight director operating modes.

Global Positioning System (GPS)

Two GPS receivers receive GPS satellite positioning signals. The left and right GPS receivers are independent and each provides an accurate airplane geographical position to the FMC and other aircraft systems. GPS operation is automatic.

GPS Displays

POS REF page 2/3 shows the left and right GPS latitude and longitude position. POS SHIFT page 3/3 shows the left and right GPS position relative to the FMC position. NAV STATUS page 1/2 shows the GPS currently in use by the FMC for position calculation.

YA371, YA372, YC201

When the navigation display plan mode is selected and POS SHIFT page 3/3 is displayed, the navigation display shows the left and right GPS symbols. The GPS symbols are identical and show as a single symbol when the GPS receivers calculate the same position.

YA373 - YA377, YC202 - YE326

When the POS (position) switch on the EFIS control panel is selected, the navigation display shows the left and right GPS symbols. The GPS symbols are identical and show as a single symbol when the GPS receivers calculate the same position.

An amber GPS light illuminates to indicate a failure of both GPS sensor units. Failure of a single GPS sensor causes the light to illuminate when either system annunciator panel is pushed.

GPS Data

FMC logic selects the position from one of the GPS sensor units as the primary update to the FMC position. When GPS position data is available, radio updating can also occur. If all GPS data becomes unavailable, the FMC position will be determined by radio or inertial (IRS) updating.

GPS navigational information can be manually deselected on the NAV OPTIONS page 2/2. No other controls are provided because the operation of the GPS is completely automatic.

GPS System Schematic

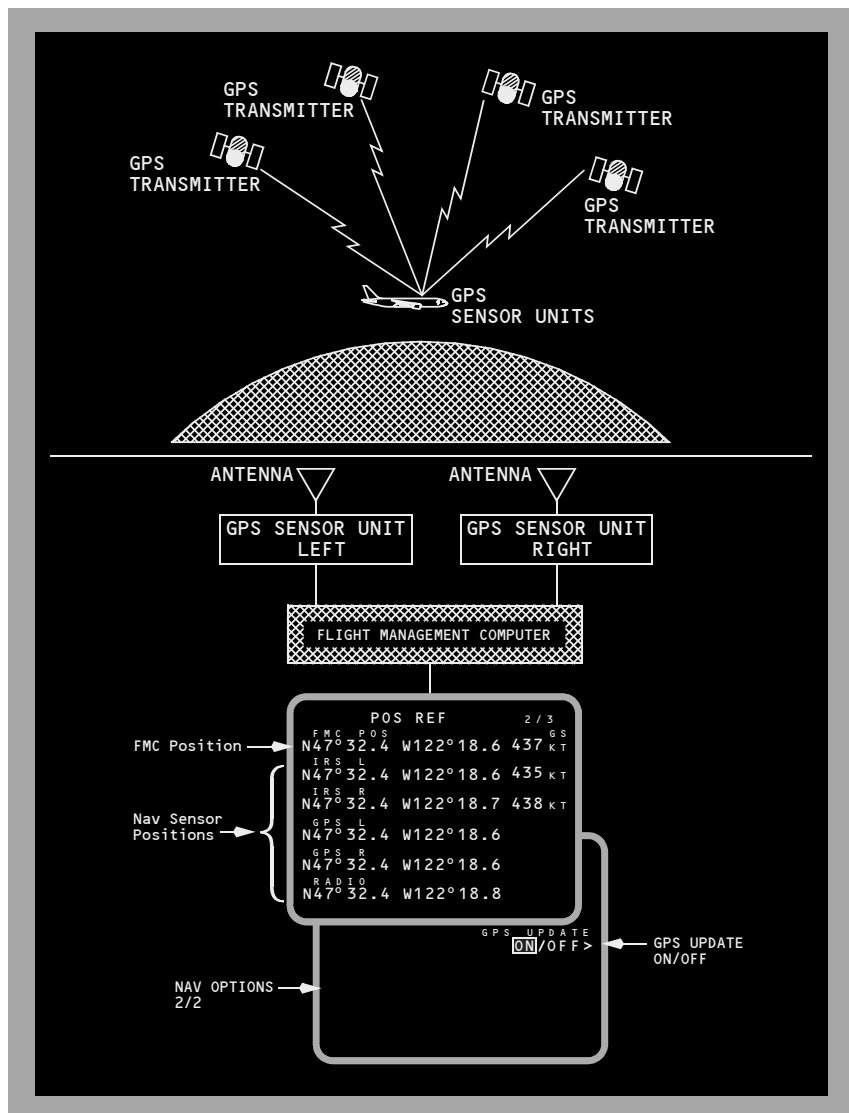

Inertial System

The inertial system computes airplane position, ground speed, and attitude data for the DUs, flight management system, autoflight system, and other systems. The major components of the inertial system are the air data inertial reference units (ADIRU), an inertial system display unit (ISDU), IRS mode select unit (MSU), and an IRS transfer switch. For information about the air data part of the system, see chapter 10. The ADIRUs provide inertial position and track data to the FMC, and attitude, altitude, and airspeed data to the CDS. Each ADIRU has an IRS section and an air data section.

Inertial Reference System

Two independent IRSs are installed. Each IRS has three sets of laser gyros and accelerometers. The IRSs are the airplane's sole source of attitude and heading information, except for the standby attitude indicator and standby magnetic compass.

In their normal navigation mode, the IRSs provide attitude, true and magnetic heading, acceleration, vertical speed, ground speed, track, present position, and wind data to appropriate airplane systems. IRS outputs are independent of external navigation aids.

IRS Alignment

An IRS must be aligned and initialized with airplane present position before it can enter the navigation mode. The present position is normally entered through the FMC CDU. If the present position cannot be entered through the FMC CDU, it may be entered through the ISDU keyboard. The airplane must remain stationary during alignment.

Normal alignment between 78 degrees 15 minutes North or South is initiated by rotating the MSU switch from OFF to NAV. The IRS performs a short power test, during which the ON DC light illuminates. When the ON DC light extinguishes and the ALIGN light illuminates, the alignment process begins. Airplane present position should be entered at this time. Alignment time varies from five minutes to seventeen minutes depending on airplane latitude.

Magnetic variation between 82 degrees north and 82 degrees south is stored in each IRS memory. The data corresponding to the present position are combined with the true heading to determine magnetic heading.

If the latitude/longitude position is not within 4 NM of the origin airport, the CDU scratchpad message VERIFY POSITION is displayed. If the entered latitude/longitude position does not pass the IRS internal comparison tests, the scratchpad message ENTER IRS POSITION is displayed.

737 Flight Crew Operations Manual

The flashing ALIGN light alerts the crew that the position entered does not pass one of the two internal comparison tests and should be checked for accuracy. If the entered position does not agree with the last stored position, the first internal test is failed, and the ALIGN light will flash. If the same position is reentered, the IRS will accept the position and continue the alignment process. A second internal position test compares the entered latitude with the system-computed latitude. If this test is failed, the ALIGN light will again flash. If two consecutive entries of the same position do not pass the second internal position test, the FAULT light will illuminate. If the test is passed, the IRS will proceed to complete the alignment process and enter NAV mode.

During transit or through-flight stops with brief ground times, a thirty second fast realignment and zeroing of ground speed error may be performed by selecting ALIGN while the airplane is parked. Present position should be simultaneously updated by manually entering latitude and longitude prior to selecting NAV.

Note: If the airplane is moved during alignment or fast realignment, the IRS automatically begins the full alignment process.

Loss of Alignment

If an IRS loses both AC and DC power, the alignment is lost. Alignment can be lost if the MSU switch is moved out of the NAV position.

If alignment is lost in-flight, the navigation mode (including present position and ground speed outputs) is inoperative for the remainder of the flight. However, selecting ATT allows the attitude mode to be used to relevel the system and provide an attitude reference. The attitude mode requires approximately thirty seconds of straight and level unaccelerated flight to complete releveling. Some attitude errors may occur during acceleration, but will be slowly removed after acceleration stops.

The attitude mode can also provide heading information, but to establish compass synchronization the crew must manually enter the initial magnetic heading. Drift of up to 15 degrees per hour can occur in the IRS heading. Therefore, when in attitude mode, an operating compass system must be periodically cross-checked and an updated magnetic heading entered in the IRS, as required.

IRS Entries

Manual IRS entries of present position or magnetic heading are normally accomplished on the POS INIT page of the FMC/CDU. The ISDU may also be used.

IRS Power

The IRSs can operate on either AC or DC power. The left IRS is normally powered from the AC standby bus, and the right IRS from the AC transfer bus 2. If AC power is not normal, either or both systems automatically switch to backup DC power from the switched hot battery bus. Backup DC power to the right IRS is automatically terminated if AC power is not restored within five minutes.

Initial power-up requires battery bus power available and the IRS mode selector to be in ALIGN, NAV, or ATT. If the IRS is turned off, it must complete a full realignment cycle before the airplane can be moved.

If AC electrical power is subsequently removed from the airplane, the switched hot battery bus continues to supply electrical power to the IRS. The ON DC light illuminates, and the ground-call horn in the nose wheel well sounds to alert maintenance personnel that the IRS is on battery power.

When the IRS mode selector is turned OFF, the IRS remains powered for approximately 30 seconds. The ALIGN light illuminates until the system is completely shut down.

Inertial System Display Unit (ISDU)

The ISDU is located on the aft overhead panel and displays data according to the position of the display selector and system selector. The ISDU also contains a keyboard for entry of present position and heading.

Mode Select Unit (MSU)

The MSU is located on the aft overhead panel and is used to select the operating mode for each IRS. Indicator lights on the MSU show status of each IRS.

IRS Transfer Switch

Should either IRS fail, the IRS transfer switch is used to switch all associated systems to the functioning IRS.

IRS Instrument Transfer Switch Schematic

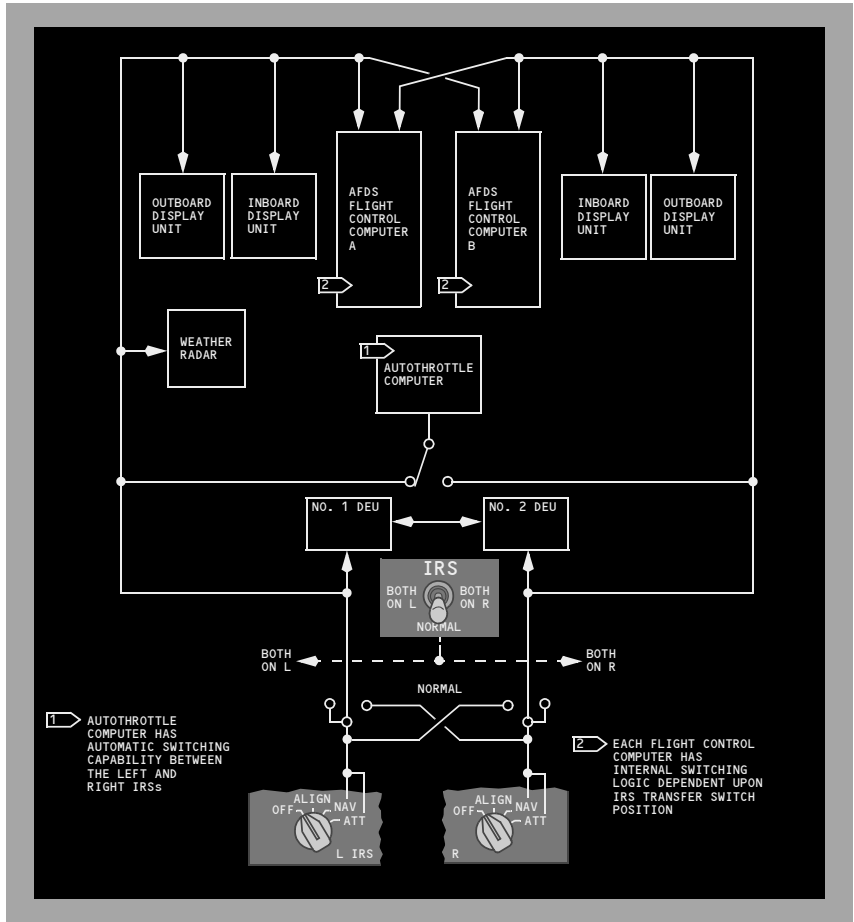

Radio Navigation Systems

Automatic Direction Finding (ADF)

An automatic direction finding (ADF) system enables automatic determination of magnetic and relative bearings to selected facilities.

One ADF receiver is installed. The ADF bearing signal is sent to the pointer on the DUs and the standby radio magnetic indicator. The audio is heard by using the ADF receiver control on the audio selector panel.

If heading or track information is lost or invalid, ADF bearing pointers on the DUs will be removed, and ADF bearing pointers on the standby radio magnetic indicator will not display correct magnetic bearing. Relative bearings indicated by pointers may be correct if the receiver is operating.

Distance Measuring Equipment (DME)

Two frequency scanning DME systems are installed.

The FMC autotunes DME receivers as necessary for position updating. During normal operations, two different DME signals or a signal from a collocated VOR/DME pair provide an accurate radio geographical position to the FMC. The identifiers of DMEs currently providing update data to the FMC are displayed on the NAV STATUS page 1/2. The radio position is displayed on the POS REF page 2/3. Specific DME station tuning for FMC position updating can be inhibited on the NAV OPTIONS page 2/2.

The flight crew must manually tune the DME on the VHF navigation control panel and the respective EFIS control panel VOR/ADF switch must be in the VOR position for DME to be displayed on the CDS. DME distance is also displayed on the CDS when the ILS receivers are tuned to a collocated DME and localizer facility.

Instrument Landing System (ILS)

Two ILS receivers are installed.

The ILS receivers are tuned manually on the VHF navigation control panel. The flight crew must manually tune the ILS for display on CDS. The ILS localizer and glideslope can also be displayed on the standby attitude indicator.

LOC updating of the FMC occurs only after the ILS is manually tuned. The tuned ILS frequency is displayed on the navigation display in the APP modes.

Navaid Identifier Decoding

YA373 - YA377, YC202 - YE326

The Morse code identifier of a tuned VOR, ILS, or ADF can be converted to alpha characters. The decoded identifier is then shown on the PFD and ND. The crew should monitor this identifier for correct navigation radio reception. The identifier name is not compared with the FMC database.

Due to the large variation in ground station identifier quality, the decode feature may incorrectly convert the intended identifier name. Examples: the Hong Kong localizer “KL” may show as “KAI,” or the Boeing Field ILS may show as “QBFI” or “TTTT” instead of “IBFI.”

Pilots should verify the identity of the tuned navigation station from the audio Morse code when the tuned frequency remains shown or an incorrect identifier is shown.

Marker Beacon

YA371, YA372, YC201

Marker beacon indications for outer, middle, and inner marker are displayed on the upper outboard corner of the Captain's and First Officer's outboard display units.

YA373 - YA377, YC202 - YE326

Marker beacon indications for outer, middle and inner marker are displayed on the upper right hand corner of the attitude display located on the Captain's and First Officer's Primary Flight Display (PFD) units.

Very High Frequency Omni Range (VOR)

Two VOR receivers are installed.

The flight crew must manually tune the VOR on the navigation control panel for display on the DUs and the standby radio magnetic indicator. VOR-DME radio updating is available if the crew manually tunes a valid in-range VOR station.

YA371, YA372, YC201

Left and right VOR bearings are displayed on the DUs when a valid in-range VOR station is tuned, the respective EFIS control panel VOR/ADF switch is in the VOR position and the respective EFIS control panel POS switch is pushed. The DUs also show course deviation.

YA373 - YA377, YC202 - YE326

Left and right VOR bearings are displayed on the DUs when a valid in-range VOR station is tuned and the respective EFIS control panel VOR/ADF switch is in the VOR position. The DUs also show course deviation.

VHF NAV Transfer Switch

Should either VOR receiver fail, the VHF NAV transfer switch enables selection of the opposite VHF NAV receiver for display.

ATC Transponder

Two ATC transponders are installed and controlled by a single control panel. The ATC transponder system transmits a coded radio signal when interrogated by ATC ground radar. Altitude reporting capability is provided.

Transmissions are automatically enabled when the air/ground system indicates air mode.

TCAS is also controlled from the transponder panel. The TCAS system is described in Chapter 15.

Transponders may also transmit information, such as flight number, airspeed or groundspeed, magnetic heading, altitude, GPS position, etc., depending on the level of enhancement. Airport equipment monitors airplane position on the ground when the transponder is active (mode selector not in STANDBY or OFF). TCAS modes should not be used on the ground for ground tracking.

Weather Radar

The weather radar system detects and locates various types of precipitation bearing clouds along the flight path of the airplane and gives the pilot a visual indication in color of the clouds' intensity. The radar antenna sweeps a forward arc of 180 degrees.

The radar indicates a cloud's rainfall intensity by displaying colors contrasted against a black background. Areas of heaviest rainfall appear in red, the next level of rainfall in yellow, and the least rainfall in green.

In map mode, the radar displays surfaces in red, yellow, and green (most reflective to least reflective).

These displays enable identification of coastlines, hilly or mountainous regions, cities, or large structures. Ground mapping mode can be useful in areas where ground-based navigation aids are limited.

The radar system performs only the functions of weather detection and ground mapping. It should not be used or relied upon for proximity warning or anticollision protection.

The turbulence mode displays normal precipitation and precipitation associated with turbulence. When the radar detects a horizontal flow of precipitation with velocities of 5 or more meters per second toward or away from the radar antenna, that target display becomes magenta. This magenta area is associated with heavy turbulence. The detection of turbulence is automatically limited to a 40 nautical mile range, regardless of the selected range.

The IDNT position activates the ground clutter reduction feature. Signals that are determined to have a high probability of originating from ground returns will be automatically removed from the display. Some portions of weather targets may be removed as well. The IDNT position is provided for analysis by the pilot and is not for continuous use.

The weather radar also provides predictive windshear alerting below 1,200 feet RA. On the ground or in flight below 2,300 feet RA, radar antenna scan sweep is limited to 120 degrees with PWS enabled. Above 2,300 feet RA the radar sweep reverts to 180 degrees. (Refer to Chapter 15, Warnings.)



Introduction

The flight management system (FMS) aids the flight crew in managing automatic navigation, in-flight performance optimization, fuel monitoring, and flight deck displays. Automatic flight functions manage the airplane lateral flight path (LNAV) and vertical flight path (VNAV). The displays include a map for airplane orientation and command markers (bugs) on the airspeed and N1 indicators to assist in flying efficient profiles.

The flight crew enters the desired route and flight data into the CDUs. The FMS then uses its navigation database, airplane position and supporting system data to calculate commands for manual or automatic flight path control.

The FMS can automatically tune the navigation radios and determine LNAV courses. The FMS navigation database provides the necessary data to fly routes, SIDs, STARs, holding patterns, and procedure turns. Lateral offsets from the programmed route can be calculated and commanded.

For vertical navigation, computations include items such as fuel burn data, optimum speeds, and recommended altitudes. Cruise altitudes and crossing altitude restrictions are used to compute VNAV commands. When operating in the Required Time of Arrival (RTA) mode, the computations include required speeds, takeoff times, and enroute progress information.

Flight Management Computer (FMC)

The basis of the flight management system is the flight management computer. Since the term FMC is universally understood, it is used here for standardization and simplification.

The FMC uses flight crew-entered flight plan information, airplane systems data, and data from the FMC navigation database to calculate airplane present position, and pitch, roll, and thrust commands required to fly an optimum flight profile. The FMC sends these commands to the autothrottle, autopilot, and flight director. Map and route information are sent to DUs. The EFIS control panels are used to select the desired information for the navigation displays. The mode control panel is used to select the autothrottle, autopilot, and flight director operating modes. Refer to the following chapters for operation of these other systems:

- Chapter 4, Automatic Flight
- Chapter 10, Flight Instruments, Displays.

The FMC and CDU are used for enroute and terminal area navigation, RNAV approaches and to supplement primary navigation means when conducting all types of instrument approaches.

The dual FMC installation is certified as a “sole source” navigation system. Airplanes equipped with two FMCs are certified to operate outside radio navaid coverage. The second FMC serves as a backup, providing complete navigational functions if the other FMC fails.

With a dual FMC installation, one FMC is always designated as primary. This is controlled by the position of the FMC Source Select switch. Refer to Chapter 11, FMC Source Select Switch.

The primary FMC:

- allocates navaid tuning and updating functions between FMCs
- insures synchronization between FMCs
- controls CDU displays
- provides input to the autopilot
- provides input to the autothrottle system
- processes ACARS (data link) messages.

Positioning the FMC Source Select Switch to BOTH ON L or BOTH ON R isolates FMC operation to use only the left or right FMC respectively. In the NORMAL position, the left FMC is primary by default. Although the aircrew can enter information into either CDU, the primary FMC is responsible for synchronizing this information with the secondary FMC and updating both CDU displays.

When external position updating is not available, the FMC uses the IRS position as reference. When the IRS is the only position reference, the FMC applies an automatic correction to the IRS position to determine the most probable FMC position. This correction factor is developed by the FMC’s monitoring IRS performance during periods of normal position updating to determine the typical IRS error value. It is important to note that, when external position updating is not available, navigation accuracy may be less than required. Flight crews should closely monitor FMC navigation, especially when approaching the destination. The accuracy of the FMC navigation should be determined during descent phase by using radio navaids and radar information if available.

Note: Inaccurate position updating may cause the airplane to deviate from the desired track.



Control Display Units (CDUs)

Two identical, independent CDUs provide the means for the flight crew to communicate with the FMC. The crew may enter data into the FMC using either CDU, although simultaneous entries should be avoided. The same FMC data and computations are available on both CDUs; however, each pilot has control over what is displayed on an individual CDU.

Intentionally
Blank



Introduction

When first powered, the FMS is in the preflight phase. As a phase is completed, the FMS automatically transitions to the next phase in this order:

- preflight
- takeoff
- climb
- cruise
- descent
- approach
- flight complete.

Preflight

During preflight, flight plan and load sheet information are entered into the CDU. The flight plan defines the route of flight from the origin to the destination and initializes LNAV. Flight plan and load sheet information provide performance information to initialize VNAV.

Required preflight information consists of:

- initial position
- route of flight
- performance data
- takeoff data.

Optional preflight data includes:

- navigation database
- SID
- STAR
- RTA data
- cruise wind
- reduced takeoff and climb thrust limits.

Each required or optional data item is entered on specific preflight pages.

Preflight begins with the IDENT page. If the IDENT page is not displayed, it can be selected from the IDENT prompt on the INIT/REF INDEX page. Visual prompts provide assistance in selecting the appropriate CDU pages. Preflight pages can be manually selected in any order.

After entering and checking the necessary data on each preflight page, the lower right line select key is pushed to select the next page. When ACTIVATE is selected on the RTE page, the execute light illuminates. The EXEC key is then pushed to complete the task of making the route active before continuing with the preflight.

If a standard instrument departure (SID) is to be entered into the route, the departure/arrival (DEP/ARR) page is selected. After selecting the desired SID, the resulting modification must be appropriately linked to the existing route and executed. This can be accomplished on the RTE or RTE LEGS page.

When all required preflight entries are complete, the preflight status prompts on the TAKEOFF REF page are no longer displayed.

Takeoff

The takeoff phase begins with selection of TO/GA and extends to the thrust reduction altitude where climb thrust is normally selected.

Climb

The climb phase begins at the thrust reduction altitude and extends to the top of climb (T/C) point. The T/C point is where the airplane reaches the cruise altitude entered on the PERF INIT page.

Cruise

The cruise phase begins at the T/C point and extends to the top of descent (T/D) point. Cruise can include step climbs and en route descents.

Descent

The descent phase begins at the T/D point or when either a level change or vertical speed descent is initiated. The descent phase extends to the beginning of the approach phase.

Approach

The approach phase begins two miles from the first waypoint of a published approach or approach transition selected from the ARRIVALS page.

Flight Complete

After landing, the flight complete phase clears the active flight plan and load data. Some preflight data fields initialize to default values in preparation for the next flight.

FMC and CDU Terminology

The following paragraphs describe FMC and CDU terminology.

Active – flight plan information currently being used to calculate LNAV or VNAV guidance commands.

Activate – designating an entered route as the active route for navigation. It is a two step process:

- push the ACTIVATE prompt
- push the execute (EXEC) key.

Altitude restriction – a crossing restriction at a waypoint.

Delete – remove FMC data and revert to default values, dash or box prompts, or a blank entry using the DELETE key.

Econ – a speed schedule calculated to minimize operating cost. The economy speed is based on the flight crew CDU–entered cost index. A low cost index reflects high fuel costs and results in a lower cruise speed.

Enter – placing an entry into the CDU scratchpad and then line selecting the information to the desired location. New characters can be typed, or existing data can be line selected into the scratchpad.

Erase – removing flight crew–entered information, which has resulted in a modification, by pushing the ERASE prompt.

Execute – making modified information part of the active flight plan by pushing the EXEC key.

Inactive – route, climb, cruise, or descent information not currently being used to calculate LNAV or VNAV commands.

Initialize – entering information required to make the system operational.

Message – information the FMC automatically writes in the scratchpad to inform the flight crew of a system condition.

Modify – active data that is changed but not yet executed. When a modification is made to the active route or performance mode, MOD is displayed in the page title, ERASE appears next to line select key 6 left, and the execute key illuminates.

Prompt – CDU displays that aid the flight crew in accomplishing a task. Prompts can be boxes, dashes, or a caret (< or >) line to remind the flight crew to enter or validate information.

Select – pushing a key to obtain the desired information or action, or to copy selected data to the scratchpad.

Speed restriction – an airspeed limit associated with a specified altitude or waypoint.

Waypoint – a point on the route. It can be a fixed point such as a latitude and longitude, VOR or ADF station, airway intersection, or a non–fixed point such as a conditional waypoint. A conditional waypoint is not necessarily associated with a land reference; it reflects a time position, or altitude requirement. An example of a conditional waypoint is “when reaching 1000 feet.”

Maintenance Index Page

The MAINT BITE INDEX page is available only on the ground and provides access to data for use by maintenance personnel.

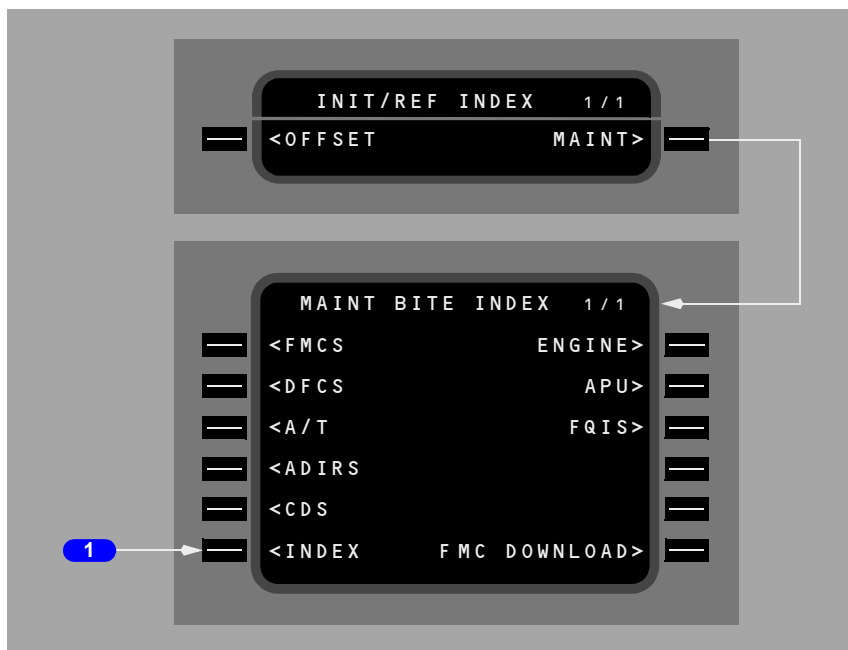

1 INDEX

Push – displays the INIT/REF INDEX page.

Navigation Position

The FMC determines present position from the IRS, GPS, and navigation radios. The FMC uses its calculated present position to generate lateral steering commands along the active leg to the active waypoint.

When the FMC Source Select Switch is positioned to NORMAL, the left FMC becomes primary, however, data from both FMCs is combined to determine a composite position and velocity for guidance and map displays.

FMC Position Update

On the ground, the FMC calculates present position based on GPS data. If GPS data is not available, the FMC calculates present position based on IRS data.

If GPS UPDATE is OFF, the FMC updates position to the takeoff runway threshold when a TO/GA switch is pushed. When making an intersection takeoff, the intersection data must be entered on the TAKEOFF REF page. If GPS UPDATE is ON, the TO/GA update is inhibited. GPS UPDATE is on the NAV OPTIONS page.

In flight, the FMC position is continually updated from the GPS, navigation radios, and IRS. Updating priority is based on the availability of valid data from the supporting systems.

FMC position updates from navigation sensor positions are used in the following priority order:

- GPS
- two or more DME stations
- one VOR with a collocated DME
- one localizer and collocated DME
- one localizer.

The station identifiers and frequencies of the selected radio navigation aids are displayed on the NAV STATUS page 1/2.

FMC logic selects the GPS position as the primary update to the FMC position. If all GPS data becomes unavailable, the FMC reverts to radio or IRS updating.

The dual frequency–scanning DME radios are automatically tuned by the FMC. The stations to be tuned are selected based upon the best available signals (in terms of geometry and strength) for updating the FMC position, unless a specific station is required by the flight plan. Radio position is determined by the intersection of two DME arcs.

If the DME radios fail, or if suitable DME stations are not available, FMC navigation is based on IRS position information only. The two VHF Nav radios are used by the FMC for localizer updating during an ILS approach and by the crew for navigation monitoring.

Note: The FMC is designed to automatically reject unreliable navaid data during FMC position updating. However, in certain conditions, navaids which are in error may satisfy the reasonableness criteria and provide the FMC with an inaccurate radio position. One of the most vulnerable times is when a radio position update occurs just after takeoff. This is usually manifested in an abrupt heading correction after engaging LNAV. The position shift can be seen on the map which will shift the desired track and runway symbol to a position significantly different from that displayed during ground roll.

Note: If the flight crew observes either of these indications, the FMC should be carefully monitored.

When adequate radio updating is not available, navigation display map mode may display a shift error. This error results in the displayed position of the airplane, route, waypoints, and navigation aids shifted from their actual positions.

An across track, undetected map shift may result in the airplane flying a ground track that is offset from the desired track. An along track, undetected map shift may result in the flight crew initiating altitude changes earlier or later than desired. In either case, an undetected map shift may compromise terrain or traffic separation.

Map shift errors can be detected by comparing the position of the airplane on the navigation display map mode with data from the ILS, VOR, DME, and ADF systems.

Navigation Performance

The FMC uses data from the navigation systems to accurately calculate the position of the airplane. The current FMC position is shown on line 1 of the POS REF page 2/3.

The FMC position is derived from a mathematical combination of the positions determined by the IRS, radio, and GPS systems. It represents the FMC's estimate of the actual position of the airplane. Its accuracy varies according to the accuracy of the other position determining systems.

Note: If the GPS position update is excessive, GPS updating is suspended until the GPS position can be determined to be reasonable.

Actual Navigation Performance (ANP)

Actual navigation performance (ANP) is the FMC's estimate of the quality of its position determination. It is shown on POS SHIFT page 3/3 and on RTE LEGS pages. ANP represents the estimated maximum position error with 95% probability. That is, the FMC is 95% certain that the airplane's actual position lies within a circle with a radius of the ANP value around the FMC position. The lower the ANP value, the more confident the FMC is of its position estimate.

737 Flight Crew Operations Manual

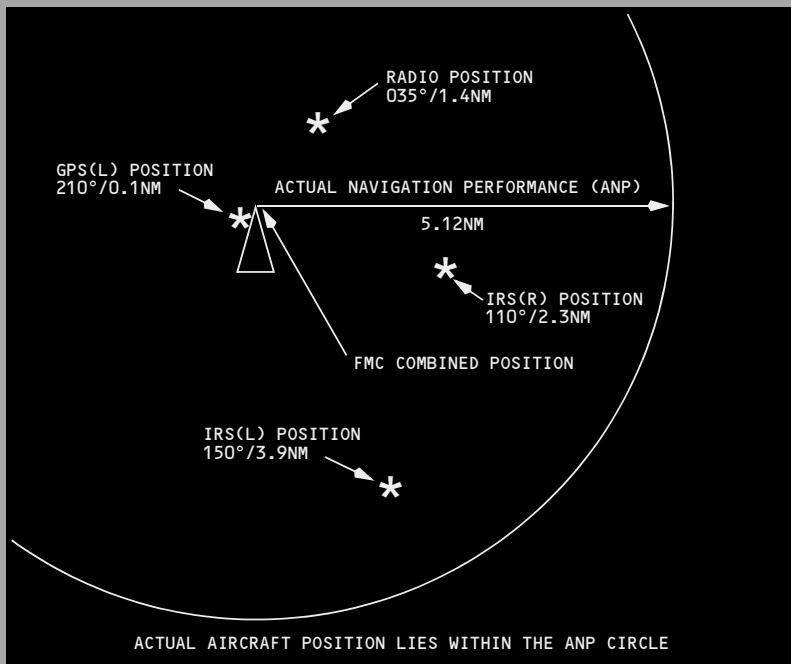

Vertical Actual Navigation Performance (VANP)

YA371, YA372, YC201, YE321 - YE323

Vertical Actual Navigation Performance (VANP) is the FMC's estimate of the quality of its altitude determination. It is shown on RNP PROGRESS page 4/4. VANP represents the estimated maximum altitude error with 99.7% probability. That is, the FMC is 99.7% certain that the airplane's actual altitude lies within a vertical band equal to plus or minus the ANP value. The lower the VANP value, the more confident the FMC is of its altitude estimate.

Note: VANP is calculated from the baro-corrected altitude provided by the Air Data System. The pilot must set the baro setting reported by ATIS or provided in the approach clearance for the 99.7% confidence level to be valid.

Required Navigation Performance (RNP)

The FMC supplies a default required navigation performance (RNP) value for oceanic, en route, terminal, and approach environments. RNP can also be supplied by the Navigation Database or may be entered by the crew. Actual navigation performance (ANP) should not exceed RNP.

Environment	Default RNP	Time to Alert
Oceanic	12.0 NM	80 sec.
En route	2.0 NM	80 sec.
Terminal	1.0 NM	60 sec.
Approach	YA373 - YA377, YC202 - YC207, YE324 - YE326 0.5 NM YA371, YA372, YC201, YE321 - YE323 0.3 NM	10 sec.

If ANP exceeds the displayed RNP value, the UNABLE REQD NAV PERF-RNP message will be displayed on the CDU scratchpad after the designated time to alert has elapsed. When in the approach environment an additional amber UNABLE REQD NAV PERF-RNP will be displayed on the MAP. The amber FMC lights located on the forward instrument panel will also illuminate with the annunciation of this message. RNP is shown on the POS SHIFT, RNP PROGRESS 4/4 and the RTE LEGS pages.

Vertical Required Navigation Performance (VRNP)**YA371, YA372, YC201, YE321 - YE323**

The FMC uses 400 feet as a default Vertical Required Navigation Performance (VRNP) value for oceanic, en route, and terminal phases of flight.

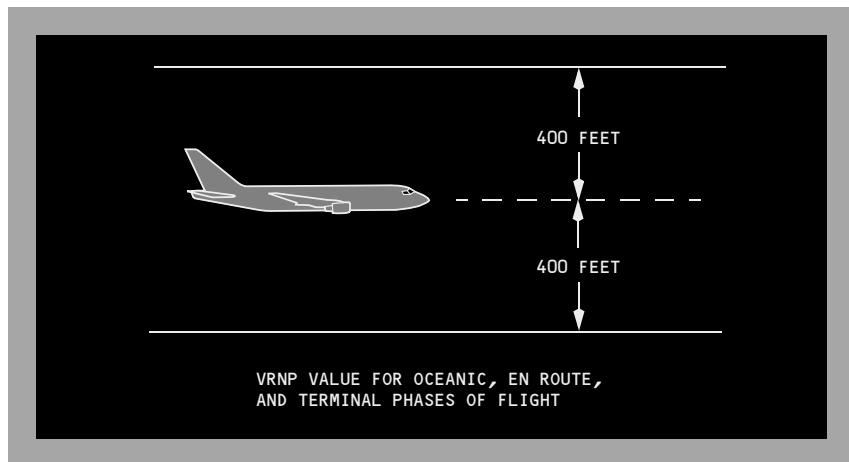

When required, VRNP values may be manually entered or displayed on RNP PROGRESS page 4/4. The FMC will accept manual entry of a VRNP value greater than the default value, but the VERIFY VERT RNP VALUE advisory message will be displayed in the scratchpad. Manual entries are cleared at flight completion.

Lateral Navigation (LNAV)

LNAV provides steering commands to the next waypoint. If selected, LNAV engages when laterally within 3 nautical miles of the active route leg. If outside of 3 nautical miles of the active route leg, LNAV engages if on an intercept heading of 90 degrees or less and the intercept will occur before the active waypoint. FMC LNAV guidance normally provides great circle courses between waypoints. However, when an arrival or approach from the FMC database is entered into the active route, the FMC can supply commands to fly a constant heading, track, or follow an arc, as required by the procedure.

Waypoints

Waypoint (navigation fix) identifiers are displayed on the CDU and navigation display.

The CDU message NOT IN DATA BASE is displayed if a manually entered waypoint identifier is not stored in the database. The waypoint can still be entered as a latitude/longitude, place-bearing/distance or place-bearing/place-bearing waypoint.

FMC-generated waypoints contain a maximum of five characters assigned according to the following rules.

Navaid Waypoint Names

VHF – waypoints located at VHF nav aids (VOR/DME/LOC) are identified by the official one, two, three or four character facility identifier. Examples:

- Los Angeles VORTAC – LAX
- Tyndall TACAN – PAM
- Riga, Latvia – RIX.

NDB – waypoints located at NDBs are identified by use of the station identifier. Example:

- Fort Nelson, CAN – YE.

Fix Waypoint Names

Fixes with one-word names – waypoints located at fixes with names containing five or fewer characters are identified by the name. Examples:

- DOT
- ACRA
- ALPHA.

Long Waypoint Names

Names with more than five characters are abbreviated using the following rules sequentially until five characters remain. Double letters are deleted. Examples:

- KIMMEL becomes KIMEL
- COTTON becomes COTON
- RABBITT becomes RABIT.

Keep the first letter, first vowel and last letter. Delete other vowels starting from right to left. Examples:

- ADOLPH becomes ADLPH
- BAILEY becomes BAILY
- BURWELL becomes BURWL.

Keep the last letter, then delete consonants from right to left. Examples:

- ANDREWS becomes ANDRS
- BRIDGEPORT becomes BRIDT
- HORSBA becomes HORS A.

Fixes with multiword names use the first letter of the first word and abbreviate the last word, using the above rules sequentially until a total of five characters remain. Examples:

- CLEAR LAKE becomes CLAKE
- ROUGH ROAD becomes RROAD.

Unnamed Point Waypoint Names

Unnamed turn points, intersections and DME fixes – if an unnamed turn point, intersection or fix is collocated with a named waypoint or navaid on a different route structure (such as low altitude routes or an approach), the name or identifier of the collocated waypoint is used. Example:

- Unnamed turn point on J2 between the Lake Charles (LCH) and New Orleans (MSY) VORTACs is coincidental with the Lafayette (LFT) low altitude VORTAC. LFT is used as the identifier for the turn point.

Identifier codes for unnamed turn points not coincidental with named waypoints are constructed from the identifier of a navaid serving the point and the distance from the navaid to the point. If the distance is 99 nautical miles or less, the navaid identifier is placed first, followed by the distance. If the distance is 100 nautical miles or more, the last two digits are used and placed ahead of the navaid identifier. Examples (NAVAID – DISTANCE – IDENT):

- INW – 18 – INW18
- CSN – 106 – 06CSN
- TCS – 89 – TCS89.

Unnamed flight information region (FIR), upper flight information region (UIR), and controlled airspace reporting points – waypoints located at unnamed FIR, UIR, and controlled airspace reporting points are identified by the three-letter airspace type identification followed by a two-digit sequence number.

Unnamed oceanic control area reporting points – positions in the northern hemisphere use the letters N and E, while positions in the southern hemisphere use the letters S and W. Latitude always precedes longitude. For longitude, only the last two digits of the three digit value are used.

Placement of the designator in the five character set indicates whether the first longitude digit is 0 or 1. The letter is the last character if the longitude is less than 100° and is the third character if the longitude is 100° or greater.

N is used for north latitude, west longitude. E is used for north latitude, east longitude. S is used for south latitude, east longitude. W is used for south latitude, west longitude. Examples:

- | | |
|----------------------------|-----------------------------|
| • N50° W040° becomes 5040N | • S52° W075° becomes 5275W |
| • N75° W170° becomes 75N70 | • S07° W120° becomes 07W20 |
| • N50° E020° becomes 5020E | • S50° E020° becomes 5020S |
| • N06° E110° becomes 06E10 | • S06° E110° becomes 06S10. |

Procedure Arc Fix Waypoint Names

Unnamed terminal area fixes along a DME arc procedure – unnamed fixes along a DME arc procedure are identified with the first character D. Characters 2 through 4 indicate the radial on which the fix lies. The last character indicates the arc radius. The radius is expressed by a letter of the alphabet where A = 1 mile, B = 2 miles, C = 3 miles, and so forth. Examples:

- EPH252°/24 = D252X
- EPH145°/24 = D145X
- GEG006°/20 = D006T.

An unnamed waypoint along a DME arc with a radius greater than 26 miles is identified as an unnamed turn point that is not coincidental with a named waypoint. Examples:

- CPR338°/29 = CPR29
- GEG079°/30 = GEG30.

When there are multiple unnamed waypoints along a DME arc with a radius greater than 26 miles, the station identifier is reduced to two characters, followed by the radius, and then a sequence character. Examples:

- CPR134°/29 = CP29A
- CPR190°/29 = CP29B
- CPR201°/29 = CP29C.

Procedure Fix Waypoint Names

Marker beacons – a marker beacon is identified by the marker type identifier followed by the runway number. Examples:

- Outer Marker 13R = OM13R
- Middle Marker 21 = MM21.

Runway-related fixes – waypoints located at unnamed runway-related fixes are identified by adding a two-letter prefix to the runway number. The following list is used to determine the appropriate prefix:

- | | |
|----------------------------------|--|
| • RX – runway extension fix | • BM – back course marker |
| • FA – VFR final approach fix | • MD – minimum descent altitude |
| • CF – final approach course fix | • A – (+ an alpha) step down fix |
| • FF – final approach fix | • RW – runway threshold |
| • IF – initial approach fix | • MA – missed approach point other than RW |
| • OM – outer marker | • TD – touchdown point inboard of RW. |
| • MM – middle marker | |
| • IM – inner marker | |

Examples: OM25L, MM09, IM23, RW04, RW18L.

For airports with more than one approach to the same runway, the two letter prefix may change to allow different identifiers for the same waypoint. The first letter identifies the type of fix and the second letter identifies the type approach as follows:

- C() – final approach course fix
- F() – final approach fix
- P() – missed approach point
- I() – initial approach fix
- D() – minimum descent altitude
- T() – touch down point
- R() – runway centerline intercept.
- ()I – ILS
- ()L – localizer only()B –backcourse ILS
- ()D – VOR/DME
- ()V – VOR only
- ()S – VOR with DME points
- ()N – NDB
- ()Q – NDB with DME points
- ()M – MLS
- ()T – Tacan
- ()R – RNAV.

Examples: CI32R, PV15, FN24L.

Unnamed turn points – unnamed turn points that are part of a procedure are identified as a latitude and longitude waypoint. These include waypoints (except conditional waypoints) defined by flying a course or track from a waypoint (except conditional waypoints) to a radial or DME distance. These waypoints are automatically entered in a route by selection of a procedure using these waypoints, from the departures or arrivals page.

Airport reference points – airport reference points are identified by the ICAO identifier.

Duplicate Waypoint Names

Duplicate identifiers – should application of these rules result in more than one waypoint having the same identifier, then a CDU page change occurs when an attempt is made to enter the duplicated identifier.

YA371 - YC206, YE321 - YE326

The page title is SELECT DESIRED WPT.

YC207

The page title is SELECT DESIRED XXX, where XXX is the three letter identifier of the waypoint in question.

The page lists the latitude and longitude of waypoints with the same identifier and the type of facility or waypoint. Selecting the latitude/longitude of the desired waypoint enters the correct waypoint on the original page. See chapter 11, section 42, “Select Desired Waypoint Page” for additional information.

When a waypoint identifier is listed in the route more than once, certain route modifications (such as DIRECT TO or HOLD) use the first occurrence of the waypoint even if the second occurrence is selected. If a new waypoint entry is attempted that has the same identifier as a waypoint already in the route, the select desired waypoint page will not be displayed and the first waypoint will be used. To use the second occurrence waypoint, the first occurrence waypoint must be deleted from the route.

Conditional Waypoint Names

Conditional waypoints are automatically entered into a route as a result of selecting a procedure on a DEPARTURES or ARRIVALS page. Normally, conditional waypoints cannot be manually entered on a route or legs page. These waypoints are events when a condition occurs and are not at a geographically-fixed position. The types of conditions are:

- passing through an altitude
- intercepting a course
- flying a heading to a radial or DME distance
- heading vector to a course or fix.

Altitude and course intercept conditional waypoints are displayed on the CDU inside (parentheses) marks. The following diagram depicts conditional waypoints.

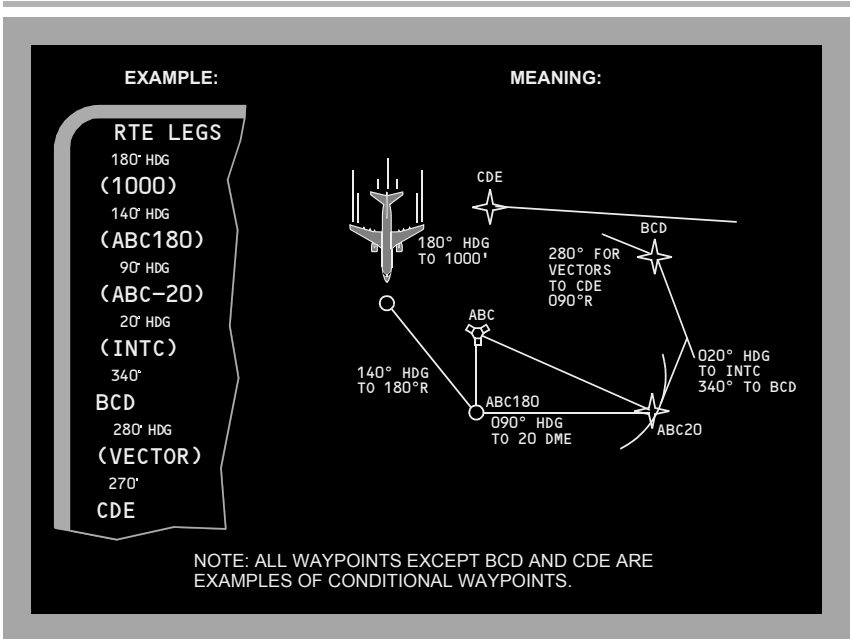

Note: When (VECTOR) is the active leg and LNAV is not engaged, the FMC automatically sequence to the next waypoint when within 3 nm of the next leg. If (VECTOR) is the active waypoint and LNAV is engaged, the FMC does not automatically sequence to the next waypoint. The next waypoint becomes active only upon EXECution of the procedures for Proceeding Direct To a Waypoint or Intercepting a Leg to a Waypoint.

Manually Entered Latitude/ Longitude Waypoint Names

Pilot defined waypoints entered as a latitude and longitude are displayed in a five-character format. The first three characters are WPT followed by a two digit sequence number. Latitude and longitude waypoints are entered with no space or slash between the latitude and longitude entries. Leading zeroes must be entered. All digits and decimal points (to 1/10 minute) must be entered unless the latitude or longitude are full degrees. Examples:

- N47° W008° is entered as N47W008 and displayed as WPT01
- N47° 15.4' W008° 3.4' is entered as N4715.4W00803.4 and displayed as WPT02.

Manually Entered Place–Bearing/Distance or Place–Bearing/Place–Bearing Waypoint Names

Waypoints entered as a place–bearing/distance or place–bearing/place–bearing are identified by the first three characters of the entry followed by a two–digit sequence number. Examples:

- SEA330/10 becomes SEA01
- SEA330/OLM020 becomes SEA02.

Manually Entered Along–Track Waypoint Names

Along–track waypoints are a special case of place–bearing/distance waypoints applied to the current route. When a waypoint is desired on the route where none exists, the along–track waypoint feature creates the desired waypoint without creating a route discontinuity.

Along–track waypoints are entered using the waypoint name (the place), followed by a slash and minus sign, for points before the waypoint, or no sign for points after the waypoint, followed by the mileage offset for the newly defined waypoint. The route course takes the place of the bearing which is not entered. The created waypoint is then inserted over the original waypoint. The distance offset must be less than the distance between the originating waypoint and next (positive value) or preceding (negative value) waypoint. Latitude and longitude waypoints cannot be used to create along–track waypoints. Examples:

- VAMPS/25 is 25 miles after VAMPS on the present route, and is displayed as VAM01
- ELN/–30 is 30 miles before ELN on the present route, and is displayed as ELN01.

Greater Than 99 Numbered Waypoints YC207

When the quantity of numbered waypoints exceeds 99 the identifier shall use the first two characters of the entry followed by the smallest three–digit sequence number beginning with 100. Examples:

- SEA104/74 becomes SE100
- SEA104/OLM064 becomes SE101.

Navigation Displays

The route is displayed on the navigation display in the map, map center, and plan modes. The display color and format represent the following status:

- an inactive route is displayed as a cyan dashed line
- an activated but not yet executed route is displayed as a cyan dashed line
- the active route is displayed in magenta
- modifications to an active route are displayed as dashed white lines
- modified waypoints are displayed in white
- executed route offsets are displayed as a dashed magenta line.

Vertical Navigation (VNAV)

VNAV provides vertical profile guidance through the climb, cruise, and descent phases of flight.

Speed/Altitude Restrictions

VNAV controls the path and speed to comply with waypoint crossing restrictions. Waypoint crossing restrictions are entered on the LEGS page waypoint line by pushing the applicable key on the right side of the CDU. Barometric altitude restrictions must be below the cruise altitude to be valid. Values entered as part of a procedure and manually entered restrictions are shown in large font. FMC predicted values do not act as restrictions, and are shown in small font.

A waypoint restriction is magenta when it is active. The restriction does not have to be in line 1 to be active.

Modified waypoint restrictions are shaded white until they are executed. Speed restriction entries require an altitude restriction at the same waypoint.

Waypoints can have altitude, airspeed or both airspeed/altitude restrictions.

All speed restrictions are considered by the FMC as at or below restrictions.

At or above altitude restrictions are entered with a suffix letter A (example: 220A).

At or below altitude restrictions are entered with a suffix letter B (example: 240B).

Mandatory altitude restrictions are entered without any suffix letter (example: 270).

Altitude restrictions that are between two altitudes are displayed with the lower limit first, followed by a suffix letter A, then the upper limit, followed by a suffix letter B (example: 220A240B).

Takeoff and Climb

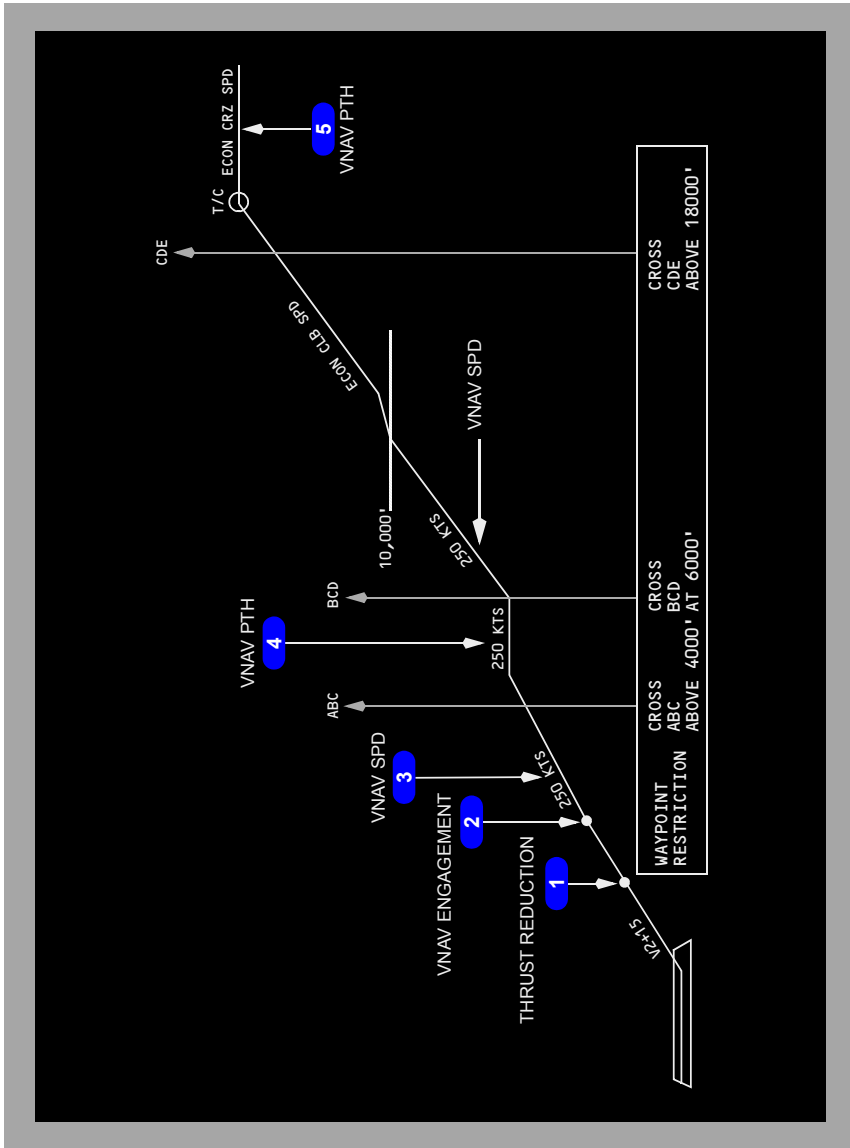

1 Thrust Reduction

Climb thrust is selected by pushing the N1 switch or automatically upon reaching the thrust reduction altitude.

2 VNAV Engagement

VNAV commands an airspeed increase to the planned climb speed profile, limited by configuration.

3 VNAV Climb

The VNAV climb profile uses VNAV SPD at the default climb speed or pilot selected climb speed to remain within all airspeed and altitude restrictions that are part of the SID entered into the active route. Autothrottle uses selected climb thrust limit.

Note: Selection of ENG OUT on the CLB page provides the crew with advisory engine out performance information.

If the climb speed profile cannot achieve an altitude restriction, the UNABLE NEXT ALTITUDE scratchpad message is shown.

4 Climb Restrictions

VNAV enters the VNAV PTH mode to remain within departure or waypoint restrictions. Speed maintained during this time can be:

- procedure based speed restriction
- waypoint speed restriction
- default VNAV climb speed
- manually entered climb speed.

5 Top Of Climb (T/C)

The point where the climb phase meets the cruise altitude is called the top of climb. Approaching this point, the FMC changes from the climb phase to the cruise phase. The T/C is shown any time the FMC calculates a change from a climb phase to a cruise phase, such as a step climb.

The T/C point is shown on the map as a green open circle with the label T/C.

Cruise

At cruise altitude, the FMC sets cruise speed at the default or pilot entered speed until reaching the top-of-descent (T/D) point. Alternate cruise speed options are:

- long range (LRC)
- flight crew entered speed.

Cruise thrust is set as required to maintain level flight at the target speed, with the autothrottle engaged. The FMC uses maximum range cruise speed if cost index is set to zero.

Fuel and ETA predictions are based on a constant altitude cruise unless a step climb altitude is entered.

Step Climb

If a step climb altitude is entered in the CRZ page STEP altitude, the FMC calculates the point where the step climb should begin.

The distance and ETA to the next step point are shown on the CRZ and PROGRESS pages. The next step point is shown on the map as a green open circle with the label S/C.

Descent

RNAV can perform a descent in either of two modes – path descent or speed descent. During a path descent, the FMC uses idle thrust and pitch control to maintain a vertical path, similar to a glideslope in three dimensions. During a speed descent, the FMC uses idle thrust and pitch control to maintain a target descent speed, similar to a level change descent.

Top Of Descent (T/D)

The point where the cruise phase changes to the descent phase is the top of descent. The T/D point is shown on the map as a green open circle with the label T/D. T/D is calculated from an end of descent (E/D) point.

Intermediate T/D points show on the map as green open circles with the label T/D-XXXXX (altitude). Intermediate T/D points exist when path segments between altitude restricted waypoints produce a level path segment. The intermediate T/D point shows where the descent will resume.

End of Descent (E/D)

The FMC calculates a descent path based on airspeed restrictions, altitude restrictions and the end of descent (E/D) point. The E/D point is shown on the map as a green open circle with the label E/D. The E/D is the last of the following which is not preceded by a lateral discontinuity:

- the runway threshold for approaches with a runway waypoint on the RTE LEGS page, or
- the missed approach point for approaches not showing a runway waypoint on the RTE LEGS page, or YC207
- the last descent waypoint, or
- the lowest “at” altitude restriction if no arrival procedure is entered.

Entering an instrument arrival procedure provides an E/D point.

If there is no E/D point, FMC predictions assume a computed profile to 1000 feet above the destination field elevation, at a position which will vary according to selection of arrival procedures. The FMC will provide a slowdown profile for approach. VNAV path descent is not available if there is no E/D point.

VNAV Descent and Approach Path

The descent path starts at the calculated top of descent (T/D) point and includes waypoint altitude restrictions. The path is based on:

- idle thrust
- descent wind speed decreasing with decreasing altitude
- speedbrakes retracted
- applicable target speed.

After the first “at” or “at or below” restriction, the path angle is constant between waypoints.

Note: When passing top of descent following high speed cruise operation (within approximately 6 knots of V_{mo}/M_{mo} , cost index of 100 or higher), VNAV may revert to LVL CHG to prevent overspeed. Reduce airspeed to the VNAV target descent speed prior to reengaging VNAV.

Normally, the target speed is economy speed above the airspeed restriction altitude and 240 knots below that altitude, until deceleration for approach. VNAV will not permit descent below the airspeed restriction altitude until the airspeed is at or below the restricted value plus ten knots. The start and end of the airport speed restriction deceleration segment is shown on the map as a green open circles with no labels.

The descent path assumes deceleration to reach the final approach fix (FAF), or the glideslope intercept point at $V_{REF} 40+20$ knots.

Target speeds are changed by entries on the DESCENT page. Entries made on the LEGS page are “at or below” and may limit the target speed. Wind and thrust assumptions are changed on the DES FORECASTS page.

Deceleration points show on the map as green open circles with the label DECEL. Deceleration points show prior to:

- airspeed constrained waypoints
- holding patterns
- approach flap extension.

If more than one deceleration segment exists in the flight plan, only the next deceleration point shows. Deceleration points can also show prior to cruise holding patterns or other speed reductions.

VNAV Path Descent

An E/D point must be defined in order to accomplish a path descent. It may be defined manually or by the selection of an arrival procedure.

YA371 - YC206, YE321 - YE326

The FMC defaults to the path descent mode for planning purposes. If the necessary information for a path descent is not available by the time the airplane reaches the T/D point, the FMC will revert to the speed descent mode.

The path descent normally begins automatically at the calculated T/D point, provided the MCP altitude is reset for the descent. If descent is not initiated by the T/D, a path descent may not be achievable. At the T/D, the FMC commands idle thrust and pitch to follow the descent path.

The descent complies with waypoint altitude restrictions by following the calculated vertical path.

Note: A path descent uses the target speed for planning purposes only. There is no attempt to maintain the target speed during the idle portion of the descent.

YA371 - YC206, YE321 - YE326

A path descent will automatically revert to a speed descent, or VNAV will disengage, if all required parameters are not maintained during descent.

Note: When descending in VNAV PTH, the FCC will disengage VNAV and switch to LVL CHG if actual speed becomes equal to or slightly less than the minimum speed, denoted by the underspeed limiting symbol in the MCP IAS/Mach window. This can also happen in turbulence or gusty conditions when the minimum speed may momentarily increase due to G loading. See section 4.20, Minimum Speed Reversion.

The FMC uses a special program called “Energy Compensation” at certain times during an ACT PATH DES. This program goes into effect when the MCP has been temporarily set to an altitude above the planned descent path. The airspeed cursor will slowly move toward a slower airspeed while the “TARGET” speed on the FMC remains constant. The airspeed reduction improves the capability of recapturing the planned descent path. When the airplane is cleared to resume the descent, the airspeed will slowly build up to the FMC target speed as the airplane recaptures the planned descent path.

The CDU message DRAG REQUIRED is displayed if an unexpected tailwind results in a significant increase in airspeed to maintain path. The CDU message DES PATH UNACHIEVEABLE is displayed if the FMC determines that the planned descent profile cannot be accomplished. VNAV disengages if a limit speed will be exceeded.

A path descent must be initiated while within the allowable cross-track error for LNAV, however LNAV may be disengaged during descent while remaining in the path mode. VNAV will remain in path regardless of cross-track.

VNAV Cruise and Path Descent Profile (Instrument Approach using VNAV)

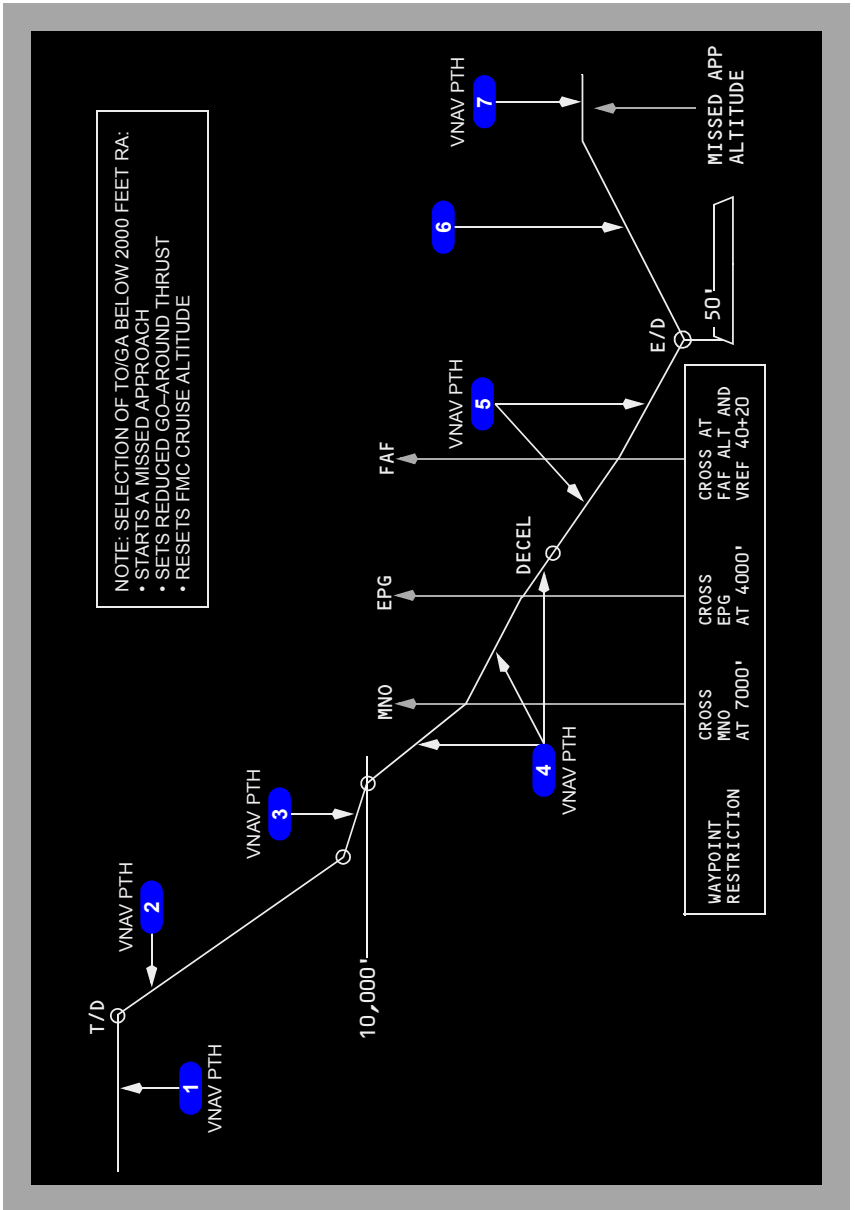

1 Cruise

Before the top of descent, FMC is in cruise mode and uses VNAV PTH and ECON cruise speed.

2 Descent

After top of descent, FMC is in descent mode and VNAV changes to economy descent speed and descends in VNAV PTH.

3 Speed Restriction Deceleration

Before the speed restriction altitude, VNAV decelerates to commanded speed using VNAV PTH.

When at restricted speed, VNAV commands decreased pitch and descends in VNAV PTH.

4 Altitude Restrictions

The VNAV path conforms to altitude restrictions at MNO, EPG, and the FAF. The thrust mode changes to FMC SPD as required to maintain the target speed.

5 Approach

VNAV descends and starts approach in VNAV PTH at the commanded speed.

6 Missed Approach

When TOGA is pushed during approach, or when crossing the missed approach point, VNAV disengages.

When selected during missed approach, VNAV engages in VNAV SPD.

7 Missed Approach Level Off

At missed approach altitude VNAV changes to VNAV PTH.

VNAV Speed Descent

A speed descent may be selected manually by selecting the SPEED prompt on the PATH DES page. With no E/D specified, the speed descent is the only descent mode available.

The speed descent maintains the target speed. Normally, the target speed is economy above the airspeed restriction altitude and 240 knots below that altitude, until deceleration is necessary for the approach. VNAV will not permit descent below the altitude restriction until the airspeed is at or below the restricted value.



737 Flight Crew Operations Manual

The speed descent normally begins automatically at the calculated T/D, provided the MCP altitude is reset for the descent. At the T/D, the FMC commands pitch to maintain target descent speed. LNAV does not have to be engaged in order to fly a VNAV speed descent.

The descent attempts to comply with waypoint altitude restrictions, and will not violate these restrictions. The VNAV speed descent will not, however, guarantee the airplane reaches an altitude restriction at the required point.

A speed descent cannot automatically revert to a path descent, except during STAR, approach transition, or approach leg with a vertical angle. However, if all required parameters for a path descent are available, a path descent may be manually selected at any time by selecting the PATH prompt on the speed descent page.

VNAV Cruise and Speed Descent Profile (Instrument Approach using VNAV)

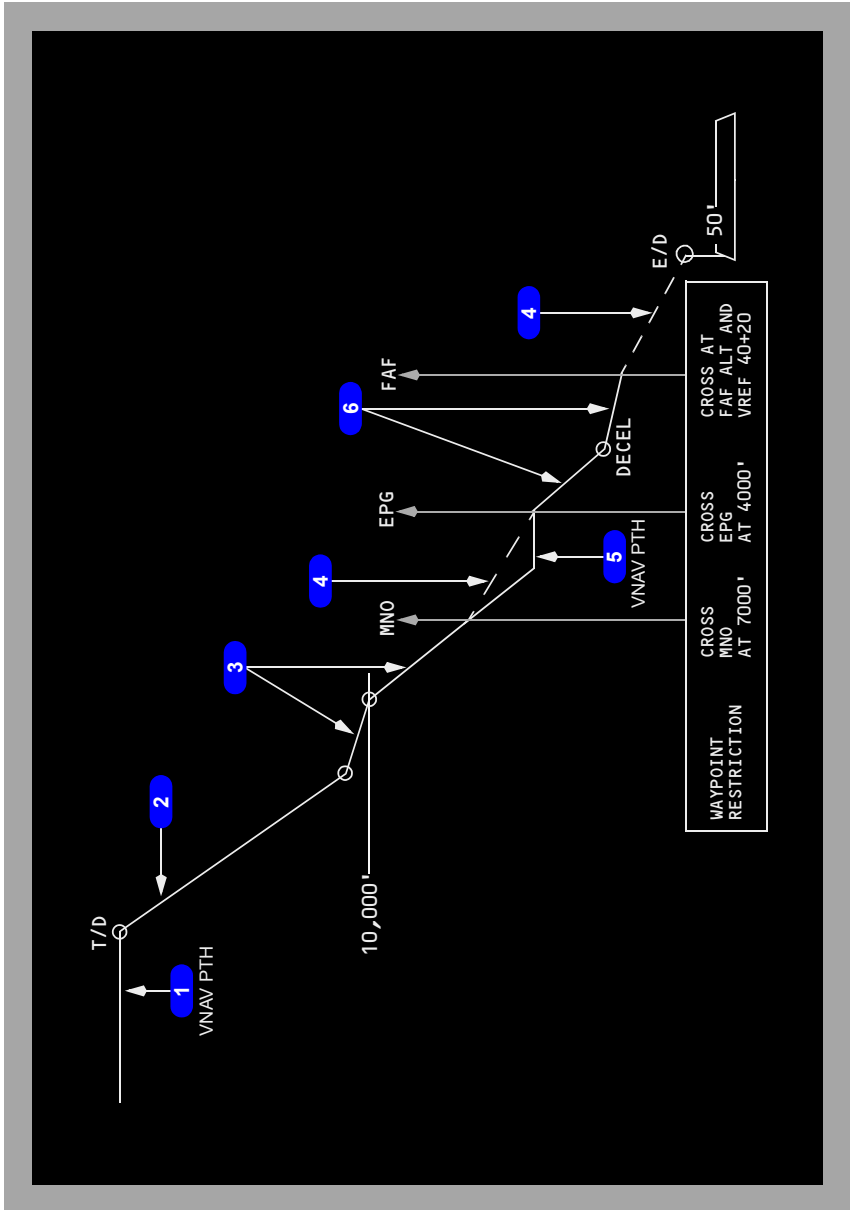

1 Cruise

Before the top of descent, FMC is in cruise mode and uses VNAV PTH and ECON cruise speed.

2 Descent

After top of descent, FMC is in descent mode and VNAV changes to economy descent speed and descends in VNAV SPD.

3 Speed Restriction Deceleration

Before the speed restriction altitude, VNAV decelerates to commanded speed using VNAV SPD.

When at restricted speed, VNAV commands decreased pitch and descends in VNAV SPD.

4 VNAV Path

During a speed descent, VNAV may not maintain the FMC computed VNAV path. However, if E/D shows, a VNAV path is available.

5 Altitude Restrictions

VNAV conforms to altitude restrictions at MNO and EPG. After MNO VNAV continues an idle thrust descent using VNAV SPD.

Upon reaching the next altitude restriction, VNAV commands level flight using VNAV PTH. The thrust mode changes to FMC SPD.

6 Descent and Approach

After EPG, VNAV continues the idle thrust descent using VNAV SPD.

Prior to the approach, VNAV decelerates to approach speed. The FMC prompts manual flap extension.

Vertical Angle

A vertical angle can be assigned to a waypoint from the navigation database. This vertical angle defines a VNAV path between the waypoint and the waypoint preceding it. This feature can be available in approaches, approach transitions, and STARs. For example, the vertical angle for the glidepath of an ILS approach would typically be 3 degrees. This angle is displayed on the ACT RTE LEGS page above the speed/altitude line for the associated waypoint. Vertical angles may be expected in any approach ending at RWXXX or MAXXX. The E/D will be RWXXX or MAXXX, and the E/D altitude will be either threshold crossing height (TCH – typically 50 feet above the touchdown zone elevation) or the altitude specified at MAXXX.

If a path (VNAV PTH) descent is active when a vertical angle leg becomes active, the path mode will remain active, but VNAV will follow the vertical angle rather than the idle thrust descent path.

If the vertical angle leg becomes active during a speed (VNAV SPD) descent, the VNAV mode will change to VNAV PTH automatically, and there will be no SPEED prompt on the descent page.

Early Descent

A descent in VNAV started before the top of descent point is an early descent. If a path descent is planned, VNAV commands a 1000 fpm descent until the idle descent path is intercepted. If a speed descent is planned, VNAV commands an idle thrust descent.

To start an early descent, use DES NOW prompt on the DES page.

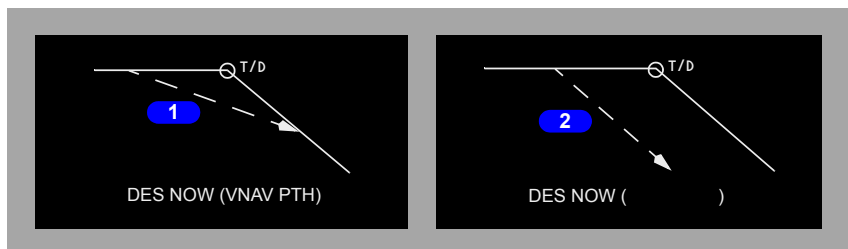

1 DES NOW (VNAV PTH)

With a VNAV path descent planned, VNAV starts an early descent at 1000 fpm and captures the idle descent path. VNAV uses FMC SPD for the autothrottle mode and VNAV PTH for the pitch mode.

2 DES NOW (VNAV SPD)

With a VNAV speed descent planned, VNAV starts an idle thrust early descent. VNAV does not attempt to capture the VNAV descent path. VNAV uses VNAV SPD for the pitch mode and the autothrottle commands IDLE, followed by ARM.

Approach

The FMC transitions to “on approach” when the airplane is within:

- 2 NM of the first approach waypoint (including approach transitions such as arcs and procedure turns), or
- 2000 feet of airport elevation, whichever occurs first.

When the FMC is “on approach”, the following features are available:

- UNABLE RNP alerting levels are higher
- when preparing for a missed approach and the MCP altitude is set at least 300 feet above the current airplane altitude, VNAV will continue to command a descent
- if the airplane is more than 200 feet below the vertical path, VNAV commands zero vertical speed until intercepting the path.

Note: Display of a specified path angle is not limited to approaches. A path angle may be defined for a leg in a STAR and displays on the RTE LEGS page for the procedure.

The FMC transitions out of “on approach” under the following conditions:

- selecting TO/GA
- the airplane lands
- the waypoint cycles to the first waypoint of the missed approach
- executing a direct-to waypoint in the missed approach.

The following situations are generally encountered during approach operations, but are not determined by “on approach” logic:

- if a vertical angle leg (GP x.xx on RTE LEGS page) becomes active, VNAV switches to VNAV PTH without pilot action
- if on a vertical angle leg, and cross track exceeds two times the RNP value, while LNAV is not engaged, VNAV will disengage.

VNAV will remain engaged at all flap settings, allowing approaches to be flown using the vertical angle guidance. Speed for final approach can be set on the APPROACH REF page.

If an ILS approach is flown in VNAV using vertical angle guidance, VNAV will disconnect when passing the GS-XXX point if G/S is armed, but it can be reengaged. If the GS-XXX point is deleted, VNAV will remain engaged throughout the approach.

For an approach without a runway waypoint on the RTE LEGS page, the VNAV path is calculated to the MDA or a calculated altitude at the missed approach point. The calculated altitude may be below the MDA to ensure a flight path angle and normal threshold crossing height.

Note: It is the flight crew's responsibility not to descend below the MDA until adequate visual contact is achieved.

Go-Around

Below 2000 feet radio altitude, a go-around can be initiated by any of the following methods:

- pushing either TO/GA switch while in a descent
- executing a direct-to waypoint in the missed approach (other than the missed approach point)
- automatically while in a descent and the last waypoint of the approach cycles to the first waypoint of the missed approach.

Once the go-around is initiated:

- the FMC transitions from active descent to active climb
- the thrust limit changes to go-around thrust
- all descent altitude constraints below the current airplane altitude are deleted and replaced with predicted altitudes
- the original destination airport (airport from which the go-around was just initiated) becomes the new origin airport allowing SID selection if a diversion to another airport is required.

Note: LNAV may be engaged when the airplane climbs above 400 feet radio altitude, but VNAV should not be engaged until after flap retraction.

If the go-around was initiated by pushing a TO/GA switch or selection of go-around thrust, the CRZ ALT will change to the highest of:

- the highest constraint in the missed approach
- 1500 feet above airport elevation
- the MCP altitude.

Note: If the MCP altitude is the lowest of the three, the autopilot, if engaged, will level off at the MCP altitude.

If the go-around was initiated by direct-to or waypoint sequencing, the CRZ ALT will change to the highest of:

- the highest constraint in the missed approach
- 1500 feet above airport elevation.

Refer to section NP20.xx, Go-Around Procedure and section 4.20, Go-Around for additional information.

VNAV Cruise (Engine Out Above Eng Out Max Alt)

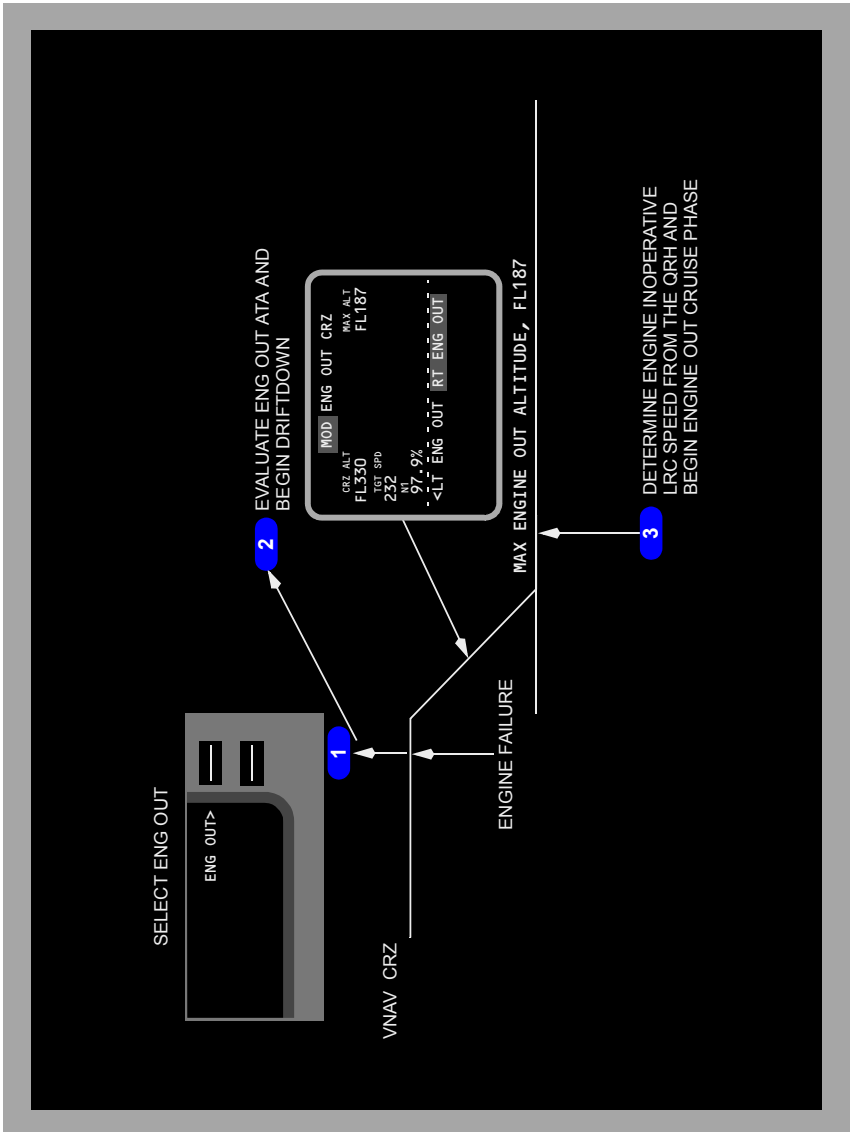

1 Engine Out Modification

Select the ENG OUT prompt on the CRZ page. The ENG OUT page displays the appropriate engine out driftdown performance data to enable the airplane to descend to the engine out maximum altitude. Refer to FMC Cruise, section 11.42 for a complete description of the ENG OUT CRZ page.

2 Drift Down Execution

After selecting the left or right ENG OUT mode, perform the driftdown as follows:

- disconnect A/T
- set maximum continuous thrust on operating engine (N1 line)
- set MCP speed to ENG OUT SPD
- set MCP altitude to MAX ALT or lower altitude as required
- select LVL CHG.

The airplane then descends at CON thrust and the driftdown airspeed to the MAX ALT. As the driftdown proceeds and airplane gross weight decreases, the maximum altitude may increase.

Note: The engine out cruise page provides advisory performance data for operating with one engine.

3 Engine Out Cruise

Engine out cruise operates like normal cruise with engine out cruise speeds. If range is a factor, determine Engine Inoperative LRC speed from the QRH. Thrust limit remains in CON.

Required Time of Arrival (RTA)

VNAV controls cruise speed to achieve a flight crew specified arrival time at a specified waypoint. After the appropriate waypoint and RTA are input to the FMC, the FMC will compute a recommended takeoff time, speeds required to comply with the RTA, and progress information for the flight. If the RTA is not achievable, the RTA UNACHIEVABLE scratchpad message is displayed.

Data Entry Rules

Altitude Entry

Altitudes can be entered into the FMC as three digit (xxx), four digit (xxxx), five digit (xxxxx), or flight level (FLxxx) numbers. The FMC automatically displays altitude or flight level entries in the proper form based on the transition altitude. Some data lines further restrict the valid entry forms.

Three digit entries represent altitude or flight levels in increments of 100 feet. Leading zeros are required.

Examples of three digit (xxx, FLxxx) entries with transition altitude = 10,000 feet:

- 800 feet is entered as 008 or FL008 and displayed as 800
- 1,500 feet is entered as 015 or FL015 and displayed as 1500
- 11,500 feet is entered as 115 or FL115 and displayed as FL115
- 25,000 feet is entered as 250 or FL250 and displayed as FL250.

Four digit entries represent feet, rounded to the nearest ten feet. Leading zeros are required. This form is used when the altitude does not exceed 9,994 feet.

Examples of four digit (xxxx) entries with transition altitude = 18,000 feet:

- 50 feet is entered as 0050 and displayed as 50
- 835 feet is entered as 0835 and displayed as 840
- 1,500 feet is entered as 1500 and displayed as 1500
- 8,500 feet is entered as 8500 and displayed as 8500
- 9,994 feet is entered as 9994 and displayed as 9990.

Five digit entries represent feet, rounded to the nearest ten feet. This form is used when the altitude exceeds 9,994 feet.

Examples of five (xxxxx) digit entries with transition altitude = 4,000 feet:

- 50 feet is entered as 00050 and displayed as 50
- 835 feet is entered as 00835 and displayed as 840
- 1,500 feet is entered as 01500 and displayed as 1500
- 8,500 feet is entered as 08500 and displayed as FL085
- 9,995 feet is entered as 09995 and displayed as FL100
- 11,500 feet is entered as 11500 and displayed as FL115
- 25,000 feet is entered as 25000 and displayed as FL250.

Negative altitude entries are allowed to -1000 feet.

Airspeed Entry

Airspeeds can be entered into the FMC as calibrated airspeed or Mach number. Calibrated airspeeds are entered as three digits (xxx) in knots. Mach numbers are entered as one, two, or three digits following a decimal point.

Data Pairs

Many CDU pages display data in pairs separated by a slash “/.” Examples of these pairs include wind direction/speed and waypoint airspeed/altitude restrictions. When entering both values in a pair, the slash is inserted between the values. When it is possible to enter only one value of the pair, the slash may not be required. When entering only the outboard value of a pair, the trailing or leading slash may be entered, but is not required before transferring to the data line. When entering the inboard value of a pair, the trailing or leading slash must be entered before transferring to the data line. Omission of the required slash normally results in an INVALID ENTRY message.

Bearing Entry

Entry of a bearing value requires three digits. For example, key 090, not 90. A bearing entry of 360 is displayed as 000.

Plus/Minus Signs

When entering temperature or an along-track displacement distance, positive values are assumed by the FMC and + signs are not required. For negative values, key in the – sign.

FMC Databases

The FMC contains two databases:

- performance database
- navigation database.

The performance database eliminates the need for the flight crew to refer to a performance manual during flight, and provides the FMC with the information required to calculate pitch and thrust commands. All information normally required can be displayed on the CDU. The database includes:

- airplane drag and engine characteristics
- maximum and optimum altitudes
- maximum and minimum speeds.

Maintenance personnel can refine the database by entering correction factors for drag and fuel flow.

The navigation database includes most information normally determined by referring to navigation charts. This information can be displayed on the CDU or navigation display. The database contains:

- the location of VHF navigation aids
- waypoints
- airports
- runways
- other airline selected information, such as SIDs, STARs, approaches, and company routes.

If the permanent database does not contain all of the required flight plan data, additional airports, nav aids, and waypoints can be defined by the crew and stored in either a supplemental or a temporary navigation database. Use of these additional databases provides world-wide navigational capability, with the crew manually entering desired data into the FMC via various CDU pages. Information in the supplemental navigation database is stored indefinitely, requiring specific crew action for erasure; the temporary navigation database is automatically erased at flight completion.

The supplemental and temporary databases share storage capacity for forty nav aids and six airports, the entries being stored in either database on a first come, first served basis. For the waypoint category, exclusive storage is reserved in the temporary database for twenty entries (including those created on the RTE or RTE LEGS pages). An additional twenty waypoints (up to a maximum of forty) can be stored in either the temporary or supplemental database on a first come, first served basis.

When any storage capacity is full, entries which are no longer required should be deleted by the crew to make space for additional new entries. Created waypoints cannot be stored in the database runway category.

The FMC contains two sets of navigation data, each valid for 28 days. Each set corresponds to the normal navigation chart revision cycle. The FMC uses the active set for navigation calculations. The contents of the navigation database are periodically updated and are transferred to the FMC before the expiration date of the current data.

Thrust Management

The autothrottle operates in response to flight crew mode control panel inputs or to automatic FMC commands. Reference thrust can be selected on the N1 LIMIT page. Automatic FMC autothrottle commands are made while VNAV is engaged. The autothrottle system:

- uses reference thrust limits calculated by the FMC
- commands the thrust levers
- commands thrust equalization through the electronic engine controls.

Thrust limits are expressed as N1 limits. Thrust equalization references N1.

The FMC calculates a reference thrust for the following modes:

- takeoff
- derated takeoff
- assumed temperature takeoff
- climb
- reduced climb
- cruise
- continuous
- go-around.

The thrust reference mode automatically transitions for the respective phase of flight. These modes can be selected on the N1 LIMIT page. The selected thrust reference mode is displayed on the thrust mode display.

The flight crew can specify the thrust reduction height where the transition from takeoff to climb thrust takes place by making an entry on TAKEOFF REF page 2. Allowable entries are 800 feet to 9,999 feet.

The default value is determined by the airline and is stored in the model/engine database.

Reduced Thrust Takeoff

Reduced thrust takeoffs lower EGT and extend engine life. They are used whenever performance limits and noise abatement procedures permit.

Takeoff Derate

Fixed derates can be selected on the N1 LIMIT page. Performance data for these derates is provided in the Airplane Flight Manual (AFM).

737 Flight Crew Operations Manual

With derated takeoff selected, the thrust setting parameter is considered a limitation for takeoff; therefore, thrust levers should not be advanced further except in an emergency. A further thrust increase following an engine failure could result in a loss of directional control while on the ground. Use the takeoff speeds supplied by the FMC or specified in Chapter PI, Performance-Inflight, for the selected derate condition.

Derated takeoff rating can be further reduced by assumed temperature.

Use the takeoff speeds specified in Chapter PI, Performance-Inflight, for the selected derate or variable takeoff rating condition.

Assumed Temperature Thrust Reduction Takeoff

A takeoff thrust less than the full rated thrust may be achieved by using an assumed temperature that is higher than the actual temperature. The desired thrust level is obtained through entry of a SEL TEMP value on the N1 LIMIT page or TAKEOFF REF page 2. Use approved sources for selecting the assumed temperature.

The maximum thrust reduction authorized is 25 percent below any certified rating. Do not use assumed temperature reduced thrust if conditions exist that affect braking, such as slush, snow, or ice on the runway, or if potential windshear conditions exist.

If the assumed temperature method is applied to a fixed derate, application of additional power should not exceed the fixed derate N1 limit as loss of directional control could occur while on the ground.

When the assumed temperature method is used with full rate, the reduced thrust setting is not considered a limitation. If conditions are encountered where additional thrust is desired, the crew can manually apply full thrust.

Derated Thrust Climb

Two fixed climb thrust derates can be selected on the N1 LIMIT page. CLB-1 provides a climb limit reduced by 3% N1 (approximately 10% thrust). CLB-2 provides a climb limit reduced by 6% N1 (approximately 20% thrust). The reduced climb setting gradually increases to full rated climb thrust by 15,000 feet. In cruise, the thrust reference automatically changes to CRZ. The reference can be manually selected on the N1 LIMIT page.

Use of an assumed temperature reduced thrust takeoff or takeoff derate affects the FMCs climb derate computation. If a reduced thrust takeoff has been specified on the TAKEOFF REF page, the FMC will re-compute CLB-1 and CLB-2 values as required to avoid a climb N1 value greater than the reduced thrust takeoff N1 value.

Use of derated climb thrust reduces engine maintenance costs, but increases total trip fuel.

Fuel Monitoring

The FMC receives fuel data from the fuel quantity indicating system. Fuel quantity values show on the PERF INIT page and on PROGRESS page 1/3.

The scratchpad message VERIFY GW AND FUEL shows if total fuel quantity data is invalid. The PERF INIT page FUEL line changes to dashes. The FMC uses the last valid fuel quantity for performance predictions and VNAV operation. The flight crew should manually enter estimated fuel weight. Periodic fuel weight update is required for the remainder of the flight to keep gross weight current. The FMC does not update the manual fuel weight entry. The scratchpad message VERIFY GW AND FUEL shows again each 30 minutes if subsequent entries are not performed. The scratchpad message does not show during descent with Vref selected.

The scratchpad message CHECK FMC FUEL QUANTITY shows if the FMC has detected an unexpected drop in fuel quantity.

The FMC continually estimates the amount of fuel that will remain when the destination airport is reached if the active route is flown. The CDU message USING RSV FUEL is displayed if the estimate is less than the fuel reserve value entered on the PERF INIT page. The CDU message INSUFFICIENT FUEL is displayed if predicted fuel at destination will be 2000 lb. (900 kg) or less.

Loss of FMC Electrical Power

The FMC requires continuous electrical power to operate. When the electrical power is interrupted for less than ten seconds:

- LNAV and VNAV disengage
- all entered data is retained by the FMC
- the FMC resumes normal operation when power is restored.

If power is lost for ten seconds or more on the ground, all preflight procedures and entries must be done again when power is restored.

If power is lost for more than ten seconds in flight:

- LNAV and VNAV disengage
- all entered data is retained by the FMC, and when power is restored the RTE LEGS page is displayed with the scratchpad message
SELECT ACTIVE WPT/LEG.

Before LNAV can engage, the FMC must be instructed how to return to the route. Select the desired active waypoint and proceed direct or intercept a course to the waypoint.

FMC Failure

Single FMC Failure

The FMC/CDU is designed to automatically preserve the most capable modes of navigation and guidance that can be maintained with the equipment and navigation aids available. If an error or system failure results in reduced capability, then the FMC may generate a crew message for display in the CDU scratchpad. If other system inputs to the FMC should fail, affected CDU displays are blanked to prevent the display of misleading or erroneous data. For example, loss of the total fuel input causes some performance related data to be blank. The messages and FMC internal responses provide an orderly transition from full FMC guided flight to less automated capability.

If the right FMC fails, the FMC alert light and the FMC message light will illuminate. The message SINGLE FMC OPERATION will be displayed in both scratchpads. VTK will display on the right navigation display. LNAV and VNAV will disengage if autopilot B is in use (can be reengaged if autopilot A is selected). After 25 to 30 seconds, the right navigation display will display failure information. The right navigation display may be restored by placing the FMC source select switch to BOTH ON L.

Note: If the above indications are observed with no VTK on the right navigation display, there is a disagreement between left and right FMC data. Moving the FMC Source Select Switch to BOTH ON L should allow the two FMCs to resynchronize. The switch may then be returned to NORMAL when the message DUAL FMC OP RESTORED is displayed on both scratch pads.

If the left FMC fails, the FMC alert light will illuminate. The MENU page will appear on both CDUs. VTK will appear on the left navigation display. LNAV and VNAV will disengage, but can be reengaged if autopilot B is in use or is selected. After 25 to 30 seconds, the left navigation display will display failure information. To restore full operation, the FMC source select switch must be moved to BOTH ON R.

Note: During an FMC software restart, the navigation display map track may rapidly slew to 0 degrees then to the correct value.

Dual FMC Failure

If both FMCs fail, the FMC alert light will illuminate. The MENU page will appear on both CDUs. VTK will appear on both navigation displays. LNAV and VNAV will disengage. After 25 to 30 seconds, both navigation displays will display failure information.

Intentionally
Blank

Company Data Link

The airplane communications system enables two-way data link communications between the FMC and airline operations. A downlink occurs when data is transferred from the FMC and transmitted through the airplane communications system to a receiver on the ground. Data may be downlinked from the FMC either manually or automatically. An uplink is the opposite of a downlink; data is transmitted from a ground station for input to the FMC. Data may be uplinked at the discretion of the airline operations dispatcher or in response to a downlink request.

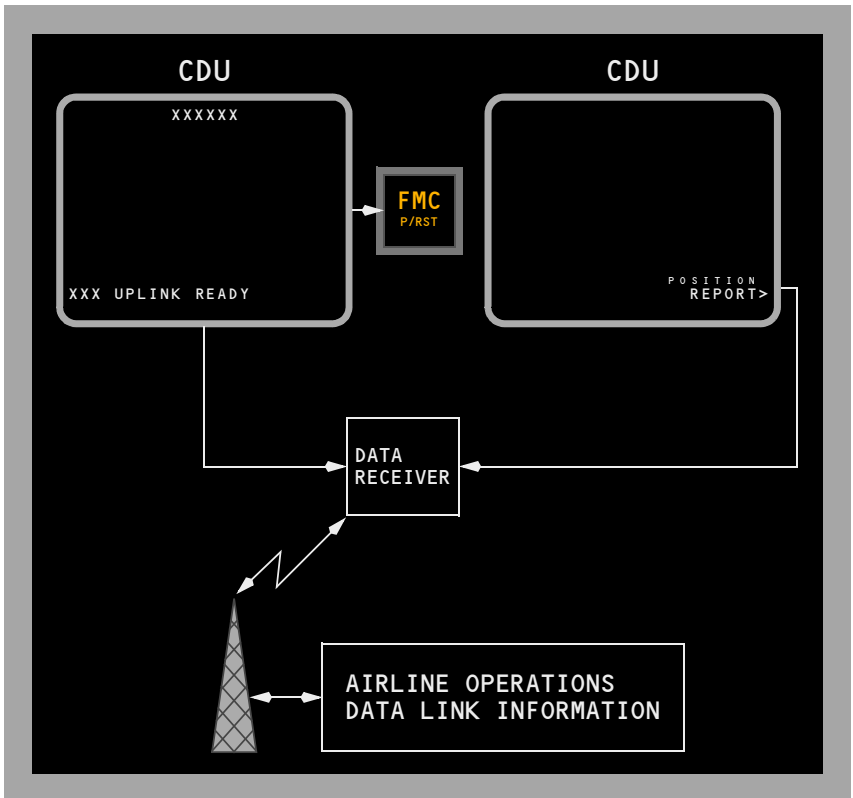

Data Link

Downlinks are data link messages transmitted to a ground station. Requests for data and reports of FMC information are two types of downlinks. Requests are made manually by the flight crew. Reports can be made manually or may occur automatically.

Uplinks are messages transmitted to the airplane. Most uplinks require manual selections by the flight crew. Some uplinks are input automatically.

Manual Downlinks

Select a REQUEST prompt to start the downlink request for data. REQUEST prompts are on PERF INIT, PERF LIMITS, TAKEOFF REF, PROGRESS, DES FORECASTS, RTE, ALTERNATE DEST, RTE DATA, and SUPP NAV DATA pages. Downlink reports of the active route may be accomplished by selection of the REPORT prompt on the PERF LIMITS or PROGRESS page and a position report may be downlinked by selection of the REPORT prompt on the PROGRESS page. The contents of the supplemental navigation database can be downlinked by selection of the REPORT prompt on the SUPP NAV DATA page.

When the communications function is unable to process FMC downlinks, the words FAIL, VOICE, NO COMM, or FULL are displayed on the CDU pages in place of the REQUEST and REPORT prompts and the header line displays the word DATALINK. The status messages are:

- FAIL
 - the ACARS management unit is inoperative
- VOICE
 - radio is operating in the VOICE mode
- NO COMM
 - radio is operational but not available
- FULL
 - all available downlink space is full.

Reports

A REPORT prompt on each page downlinks a unique report applicable to that page. The pages below contain report prompts.

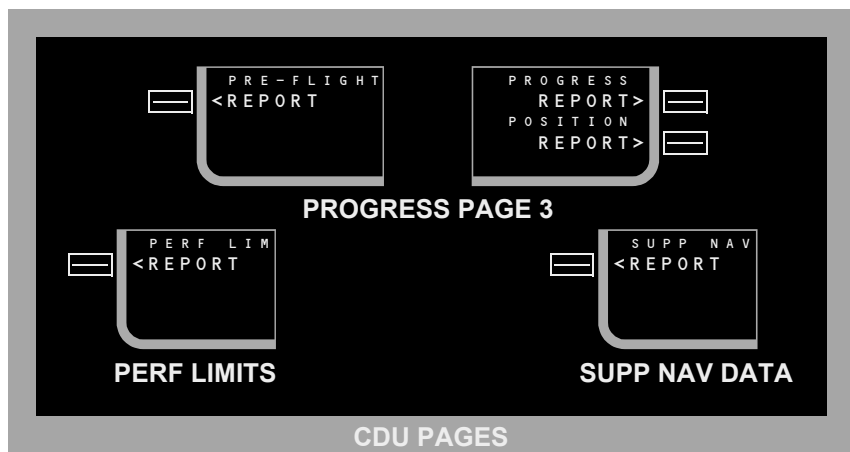

Report Status

Below is a typical sequence of status in response to sending a report.

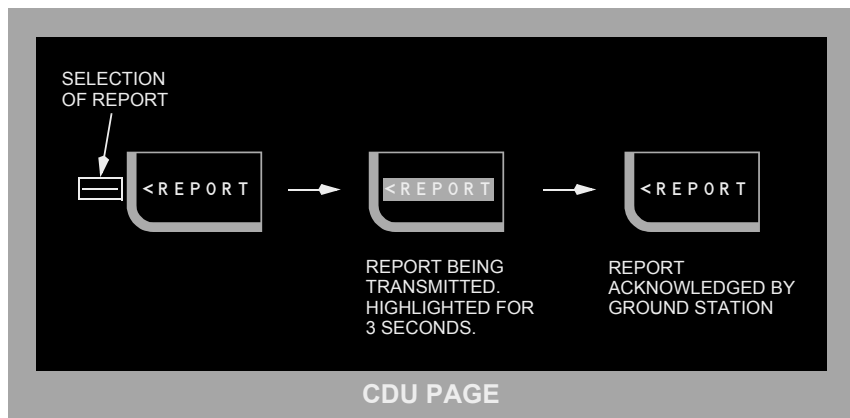

Automatic Downlinks

The FMC can be configured by the airline to automatically transmit downlinks of FMC data at predetermined points during the flight or in response to specific information requests from the airline dispatcher. The FMC response in these cases is completely automatic and no crew action is necessary.

Uplinks

Uplinked data may be loaded automatically or may require flight crew action. Three uplinks automatically load data into the FMC when the REQUEST prompt is selected and do not require execution.

Uplinked data that waits in system memory for flight crew action are considered to be pending. A pending uplink is included or discarded when the flight crew selects the applicable prompt. Flight crew response to an uplink depends on the type of uplink. Flight crew action is made with ACCEPT/REJECT or LOAD prompts, FMC modification ERASE prompt or EXEC key, or when the page with the uplink is selected.

Data can be uplinked from the airline dispatcher directly to the FMC. The uplinks are annunciated to the crew by the FMC alert lights. The uplink is identified by a CDU scratchpad message.

PERF INIT uplinks are available only on the ground and after an origin airport has been entered on the RTE page.

RTE DATA cruise winds are available when not in descent and a cruise altitude and a flight plan route exist.

DES FORECASTS winds are available if a cruise altitude exists.

Long Delete Function

During uplink, CDU keys are ignored until data is loaded into the FMC. The uplink may be suspended by pressing and holding down the DEL key for at least one second. For all uplinks, except SUPP NAV DATA uplinks, the loaded data is then removed from the flight plan and placed back into the ready to be loaded state. Uplinks that do not generate a modified plan are reloaded when there has been no CDU pushbutton activity for 30 seconds. Uplinks that do generate a modified plan can be reloaded using the LOAD prompt on the appropriate page.

When the long delete is used during a SUPP NAV DATA uplink, the uplink is suspended, but the data loaded up to that point remains in the database. After 30 seconds of keyboard inactivity, the remaining data is loaded.

Requests

A REQUEST prompt on each page downlinks a unique request applicable to that page. The pages below contain request prompts.

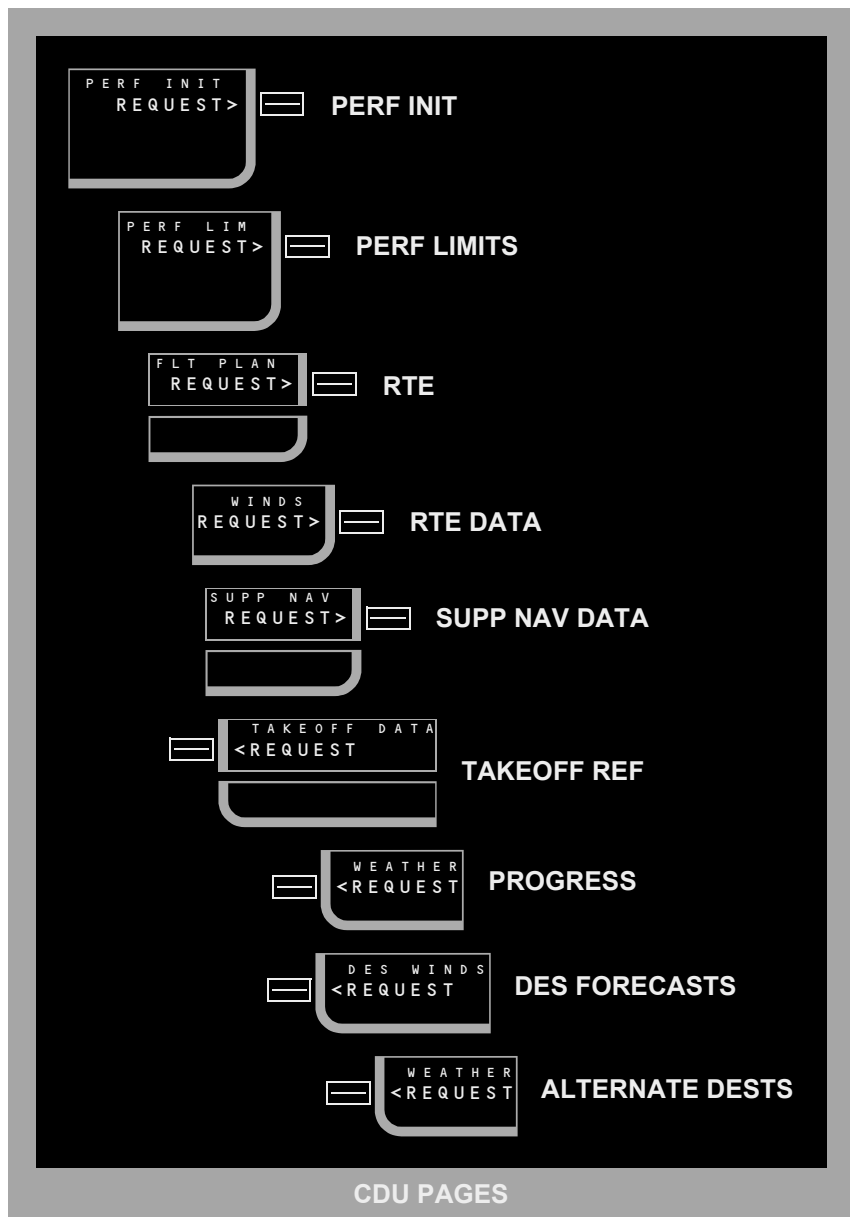

Request Status

Below is a typical sequence of status in response to sending a request.

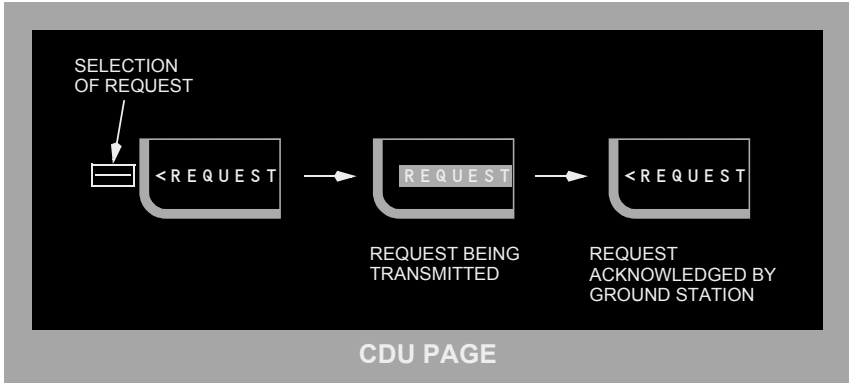

FMC Data Link Uplinks (Accept/Reject)

ACCEPT and REJECT are shown on the TAKEOFF REF 1/2 page following receipt of uplink data.

Uplink data for the current runway is shown initially in small font for preview.

Selecting ACCEPT:

- displays uplinked data in large font
- replaces previous data with uplinked data
- returns page display to normal (pre-uplink) format
- clears scratchpad message
- transmits a downlink accept message (if enabled) to acknowledge acceptance.

Selecting REJECT:

- replaces uplinked data with previous data
- returns page display to normal (pre-uplink) format
- clears scratchpad message
- transmits a downlink reject message (if enabled) to inform of rejection.

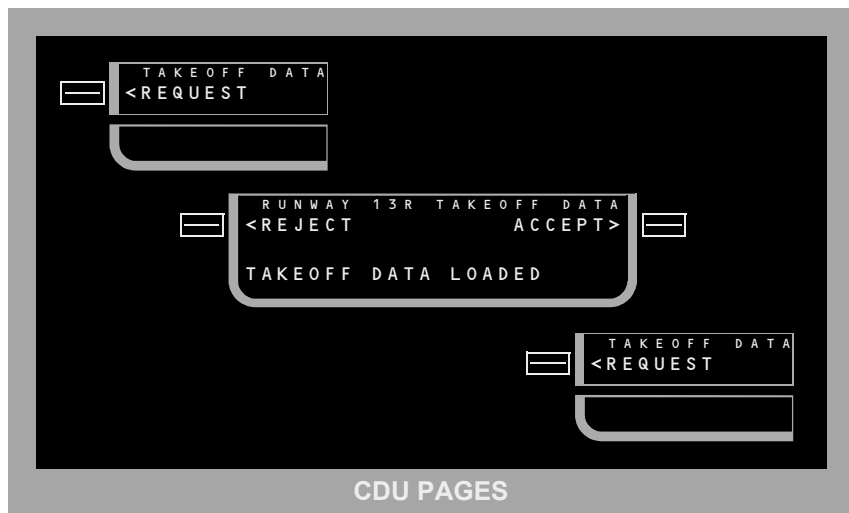

FMC Data Link Uplinks (Load/Activate/Exec)

LOAD is shown on the RTE page after receipt of uplink data. After the uplinked data is loaded, the ACTIVATE prompt is shown. After selecting ACTIVATE, the EXEC light illuminates.

Selecting LOAD:

- loads uplinked data into FMC for viewing
- updates scratchpad message
- transmits a downlink accept message (if enabled) to acknowledge acceptance.

Selecting ACTIVATE and EXEC:

- puts uplinked data in active flight plan
- returns page display to normal (pre-uplink) format
- clears scratchpad message
- transmits a downlink accept message (if enabled) to acknowledge acceptance.

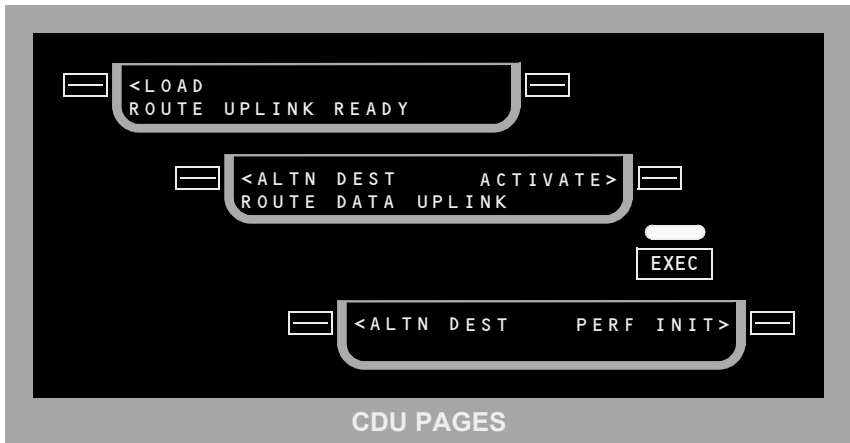

FMC Data Link Uplinks (Load/Exec-Erase)

LOAD shows on the PERF INIT, PERF LIMITS, RTE DATA, and DES FORECASTS pages after receipt of uplink data.

After the uplinked data is loaded, the EXEC light illuminates and the ERASE prompt is displayed.

Selecting LOAD:

- loads uplinked data into FMC for viewing
- updates scratchpad message
- uplinked data modifies previous data

737 Flight Crew Operations Manual

- ERASE prompt displays
- EXEC light illuminates.

Pushing the EXEC key:

- incorporates modified data into active flight plan
- clears scratchpad message
- returns page display to normal (pre-uplink) format
- transmits a downlink accept message (if enabled) to acknowledge acceptance.

Selecting ERASE:

- removes modified data
- clears scratchpad message
- returns page display to normal (pre-uplink) format.
- transmits a downlink reject message (if enabled) to inform of rejection.

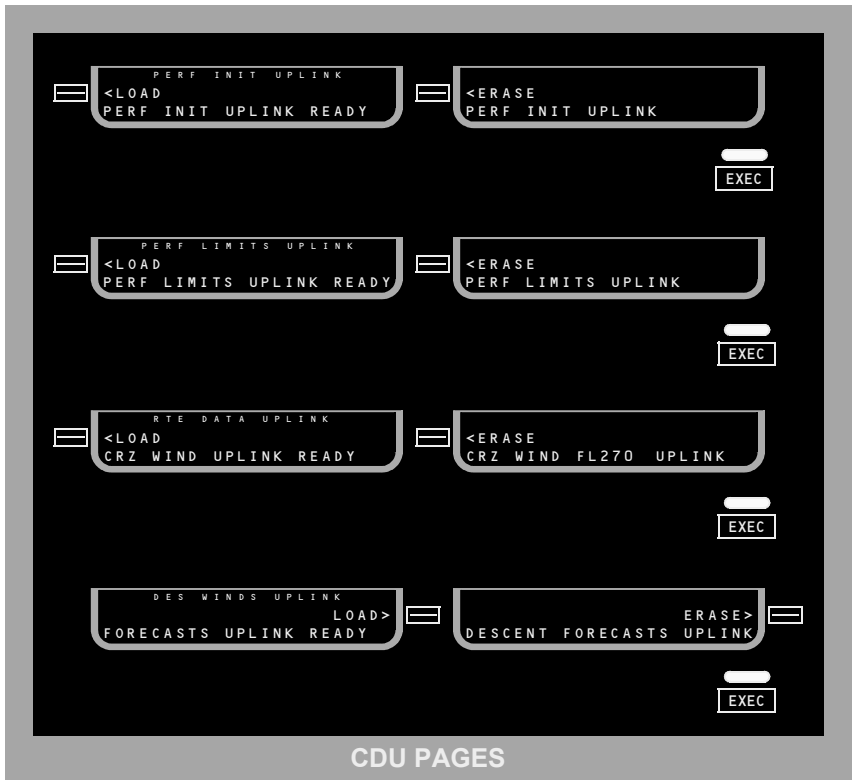

FMC Data Link Uplinks (Request)

Selecting the REQUEST prompt is the only action required to uplink data on the PROGRESS, ALTERNATE DEST, and SUPP NAV DATA pages.

After the uplinked data is loaded, an uplink message appears in the scratchpad.

Selecting REQUEST:

- loads uplinked data into FMC
- displays scratchpad message when uplink complete
- uplinked data modifies previous data.

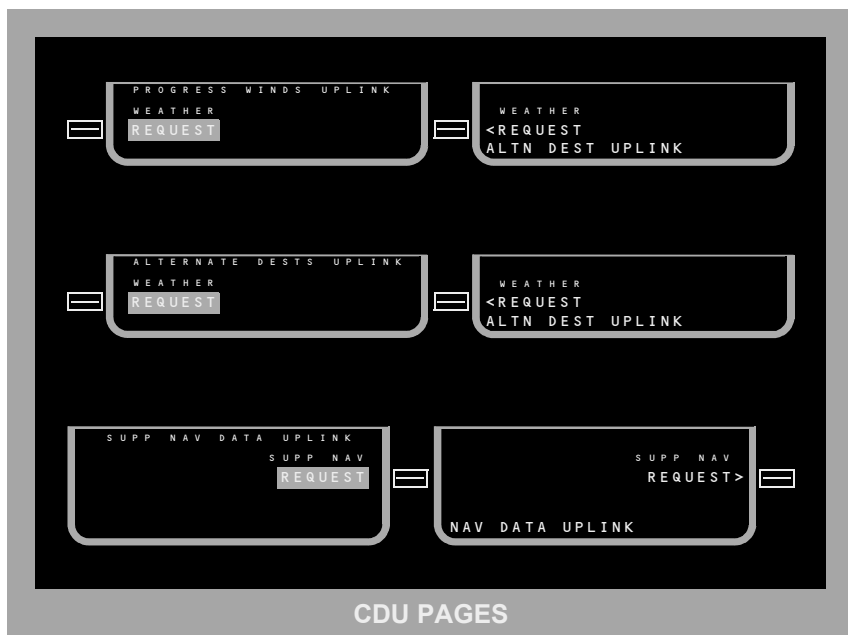

FMC Data Link Uplinks (Automatic)

Data can be automatically uplinked.

The scratchpad message XXXXX UPLINK READY is displayed and the FMC alert light illuminates.

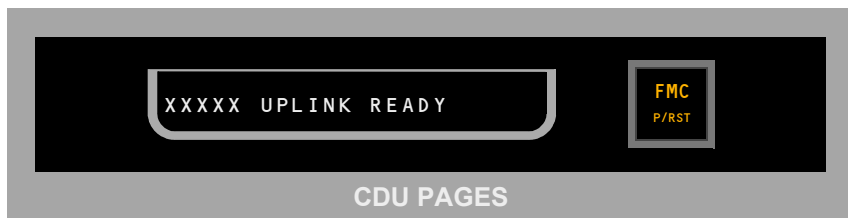

Data Link Management

The flight crew should monitor system status of FMC data link by observing status displays on CDU pages.

CDU Data Link Status Displays

Data link operation is verified when the correct line title is above the related prompt. In the example below, the line title TAKEOFF DATA is above the REQUEST prompt on the TAKEOFF REF page.

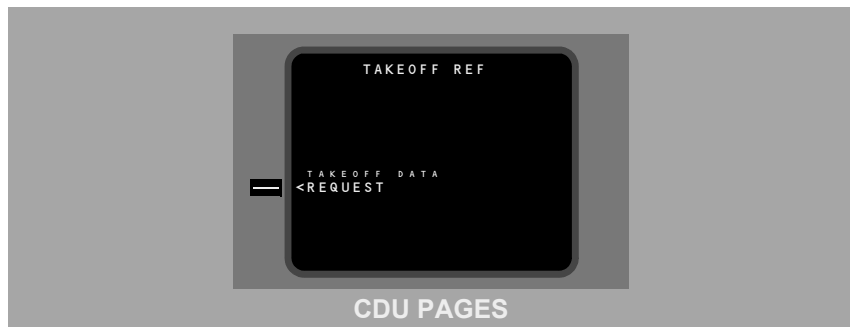

When the data link system is not operating, CDU page prompts change to FAIL, VOICE, NO COMM or FULL and the headings change to DATALINK. A typical example is shown below.

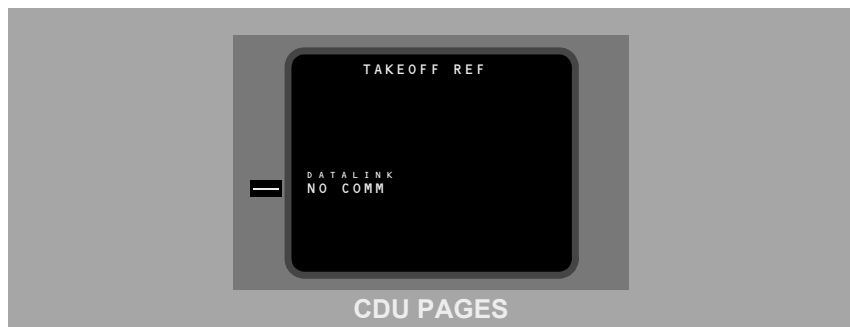



Intentionally
Blank



Introduction

Completion of the FMC preflight requires data entry in all minimum required data locations. Completing all required and optional preflight data entries ensures the most accurate performance possible.

Data link can be used to load preflight data from airline ground stations. Using data link reduces the required crew actions. Manual crew entries replace existing data. Data link can also be used to load takeoff data onto the TAKEOFF REF pages.

Preflight Page Sequence

The normal preflight sequence follows paging prompts on each CDU page.

The normal FMC power-up page is the identification page. Preflight flow continues in this sequence:

- identification (IDENT) page
- position initialization (POS INIT) page
- route (RTE) page
- DEPARTURES page (no automatic prompt)
- performance initialization (PERF INIT) page
- with U10.1 or later installed:
 - N1 LIMIT page
 - takeoff reference (TAKEOFF REF) page.

Some of these pages are also used in flight.

Minimum Preflight Sequence

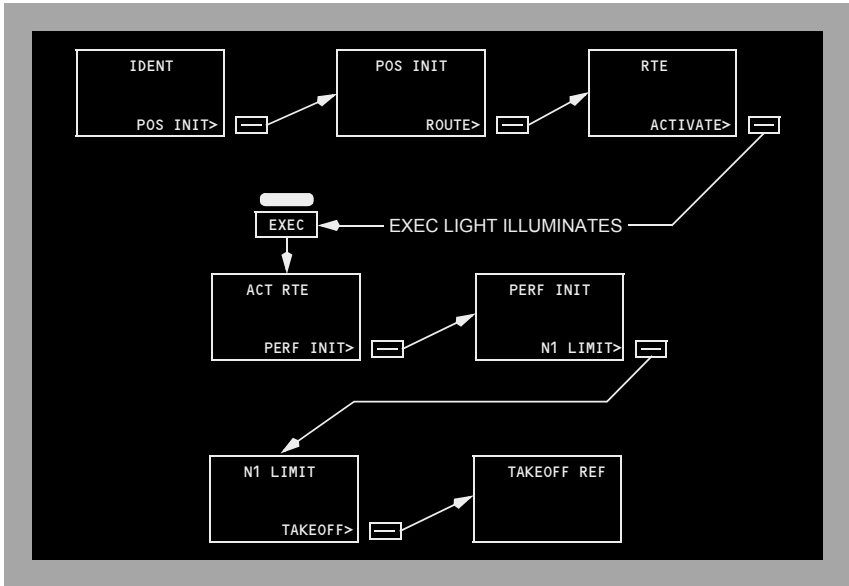

During preflight, a prompt in the lower right of the CDU page automatically directs the crew through the minimum requirements for preflight completion. Pushing the prompt key for the next page in the flow presents new entry requirements. Additional entries are made on pages to refine the performance and route calculations. If a required entry is missed, a prompt on the TAKEOFF page leads the crew to the preflight page that is missing data.

The airplane inertial position is required for FMC preflight and flight instrument operation.

A route must be entered and activated. The minimum route information is origin and destination airports and a route leg.

Performance information requires the airplane weight and cruising altitude.

Supplementary Pages

Supplementary pages are sometimes required. These pages must be manually selected. Manual selection interrupts the normal automatic sequence. Discussions of each normal page include methods to display the page when the automatic sequence is interrupted.

When the route includes SIDs and STARs, they can be entered into the preflight using the DEPARTURES or ARRIVALS pages.

737 Flight Crew Operations Manual

Route discontinuities are removed, the route is modified, and speed/altitude restrictions are entered on the RTE LEGS page. The RTE LEGS page is described in the FMC Takeoff and Climb and FMC Cruise sections of this chapter.

Waypoint, navigation, airport, and runway data is referenced on the REF NAV DATA page or the SUPP NAV DATA page. The REF NAV DATA page and SUPP NAV DATA page are described in the FMC Cruise section of this chapter.

VNAV performance is improved if the forecast winds and temperatures are entered during the preflight.

A single wind and temperature for cruise may be entered on the PERF INIT page. Wind and temperature data for specific cruise waypoints are entered on the RTE DATA page. The RTE DATA page is described in the FMC Cruise section. Wind and temperature for descent is entered on the DES FORECASTS page. The DES FORECASTS page is described in the FMC Descent section.

Preflight Pages

The preflight pages are presented in the sequence used during a typical preflight.

Initialization/Reference Index Page

The initialization/reference index page provides manual selection of FMC pages. It provides access to pages used during preflight and not normally used in flight.

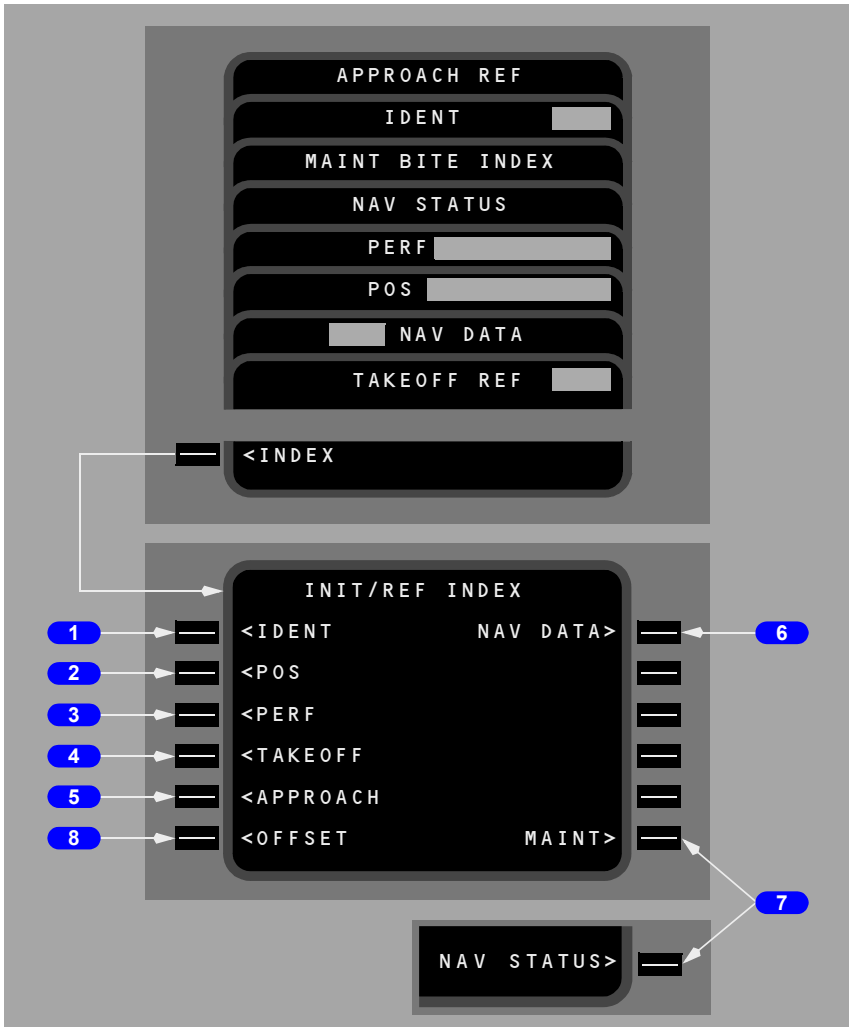

1 IDENT

Push – displays the IDENT page, the first page in the automatic preflight sequence.

2 Position Initialization (POS)

- Push – displays the POS INIT page used for IRS initialization.
- POS INIT page is also used to enter/update magnetic heading for an IRS which is in the ATT mode.

3 Performance Initialization (PERF)

Push – displays the PERF INIT page for initialization of data required for VNAV operations and performance predictions.

4 Takeoff Reference (TAKEOFF)

Push – displays the TAKEOFF REF page to enter takeoff reference information and V speeds.

5 APPROACH

Push – displays the APPROACH REF page for entry of the approach VREF speed.

6 Navigation Data (NAV DATA)

Push – displays the REF NAV DATA page to display information about waypoints, navaids, airports, and runways. On the ground, displays the SUPP NAV DATA page if SUPP is entered in the scratchpad prior to selection.

7 Maintenance (MAINT) or Navigation Status (NAV STATUS)

- MAINT – On ground only.
Push – displays maintenance pages for maintenance use.
- NAV STATUS – Replaces MAINT prompt when in air.
Push – displays NAV STATUS page which shows status of navigation aids being tuned by the FMC. Replaces MAINT prompt when in air.

8 OFFSET

Push – displays the LATERAL OFFSET page for initiating a lateral offset.

Identification Page

Most of the data on this page is for crew verification. Active date accepts manual entries.

The crew verifies FMC data and selects a navigation database on the identification page.

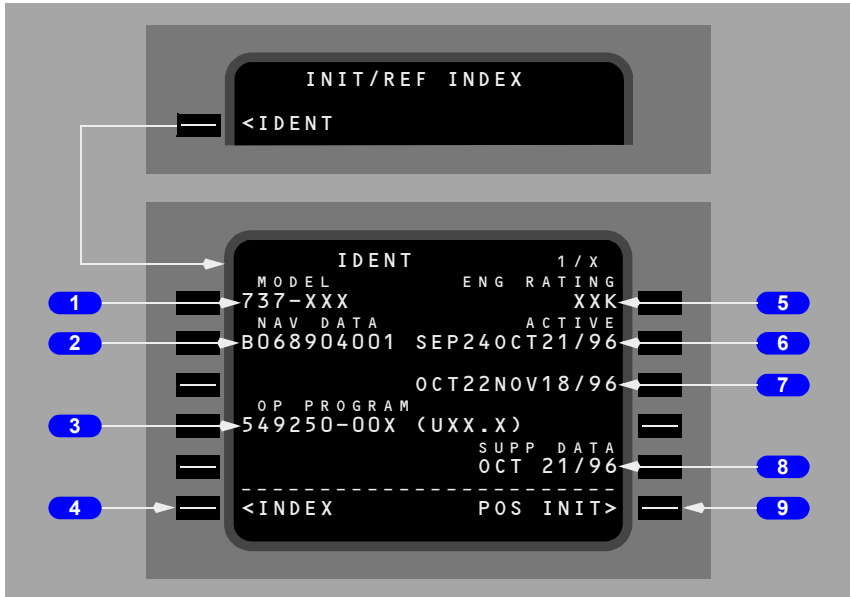

1 MODEL

Displays the airplane model from the FMC performance database (e.g., 737-600, 737-700, 737-800 or 737-900).

2 Navigation Data (NAV DATA)

Displays the navigation database identifier.

3 Operational Program (OP PROGRAM)

Displays the Boeing software part number and update version. Update version installed at delivery:

- YA371 - YC206, YE321 - YE326
- Update 10.5 (U10.5) or 10.5A (U10.5A)
- YC207
- Update 10.6 (U10.6)

4 INDEX

Push – displays the INIT/REF INDEX page.

5 Engine Rating (ENG RATING)

Displays the engine thrust stored in the FMC performance database (e.g., 20K, 22K, 24K, 26K or 27K).

6 ACTIVE Date Range

Displays the effectivity date range for the active navigation database.

Database activation is accomplished by pushing the proper date range prompt to copy that date into the scratchpad. The scratchpad date may then be transferred to the ACTIVE database line. The previous active date moves down to the inactive date line.

The ACTIVE label appears above the active navigation database date. No label appears above the inactive navigation database date. The navigation database date can be changed only on the ground. Changing the navigation database removes all previously entered route data.

When an active database expires in flight, the expired database continues to be used until the active date is changed after landing.

7 Inactive Date Range

Displays the effectivity date range for the inactive navigation database.

8 Supplemental Data (SUPP DATA)

Displays the effective date of supplemental data. Blank if supplemental database is empty.

9 Position Initialization (POS INIT)

Push – displays the POS INIT page.

Position Initialization Page 1/3

The position initialization page 1/3 allows airplane present position entry for IRS alignment and FMC initialization. The same page is used to enter/update the magnetic heading for an IRS which is in the ATT mode. There are three POS pages.

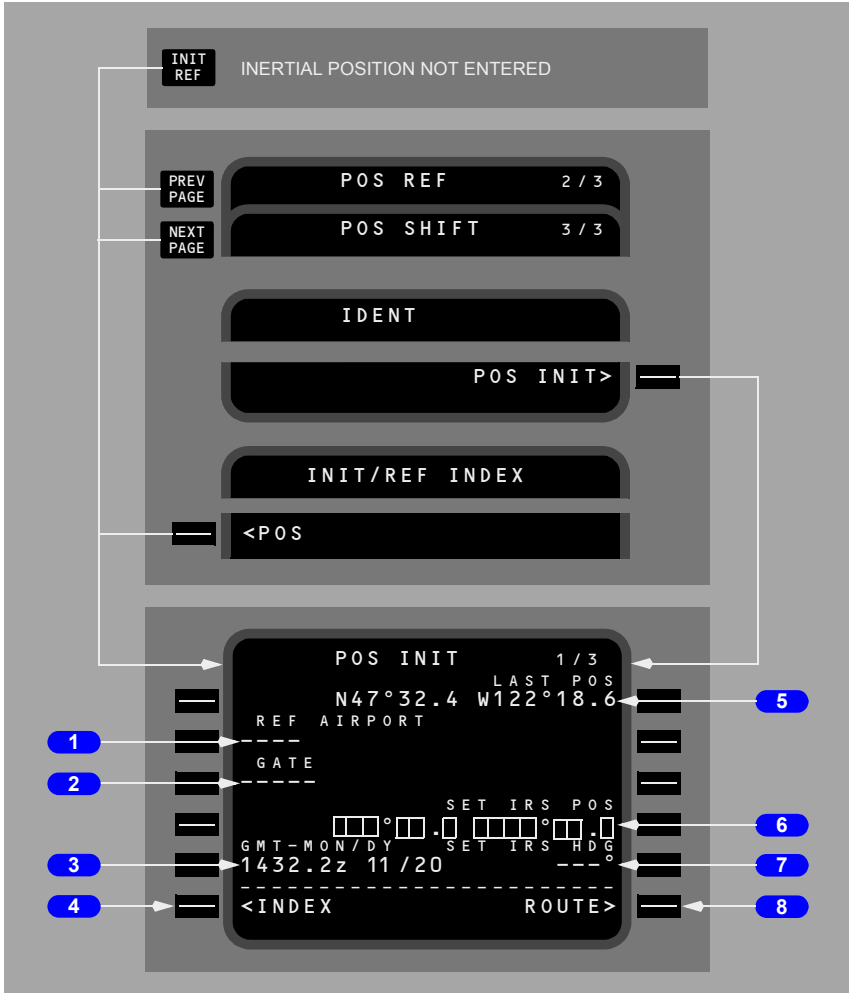

1 Reference Airport (REF AIRPORT)

The reference airport entry allows entry of the current airport for display of the airport latitude/longitude.

Optional entry.

737 Flight Crew Operations Manual

Valid entries are ICAO four letter airport identifiers.

Displays the latitude and longitude of the reference airport.

Removes previous GATE entry.

Entry blanks at lift-off.

2 GATE

The gate entry allows further refinement of the latitude/longitude position.

Optional entry after the reference airport is entered.

Valid entry is a gate number at the reference airport.

Displays the latitude and longitude of the reference airport gate from the navigation database.

Changes to dashes when a new reference airport is entered.

Entry blanks at lift-off.

3 GMT – Month/Day (GMT – MON/DY)

Displays GPS time and date. If the GPS time is not valid, GMT starts at 0000.0Z when the FMC is first powered. MON/DY is blank. Manually enter the correct GMT.

4 INDEX

Push – displays the INIT/REF INDEX page.

5 Last Position (LAST POS)

Displays the last FMC computed position.

6 Set IRS Position (SET IRS POS)

The set inertial position entry is required to initialize the IRS. Select the most accurate latitude/longitude for the initialization. A displayed latitude/longitude can be selected or a manual entry can be used.

If an entry is not made before the IRS finishes the initial alignment, the scratchpad message ENTER IRS POS is displayed.

Failure of the manually entered position to pass the IRS internal check displays the scratchpad message ENTER IRS POS.

Enter airplane position latitude and longitude.

Box prompts are displayed when either IRS is in the ALIGN mode and IRS present position has not been entered.

Blanks when the IRS transitions from the alignment to the navigation mode.

7 Set IRS Heading (SET IRS HDG)

Enter/update magnetic heading for any IRS which is in ATT mode. Line blanks when IRS not in ATT mode.

8 ROUTE

Push – displays the ROUTE page.

Position Reference Page 2/3

Position reference page 2 displays the airplane positions as calculated by the FMC, IRS, GPS, and radio navigation receivers.

This page displays latitude/longitude. All position displays are in actual latitude and longitude, as calculated by the respective system. Ground speed is displayed for the FMC and each IRS.

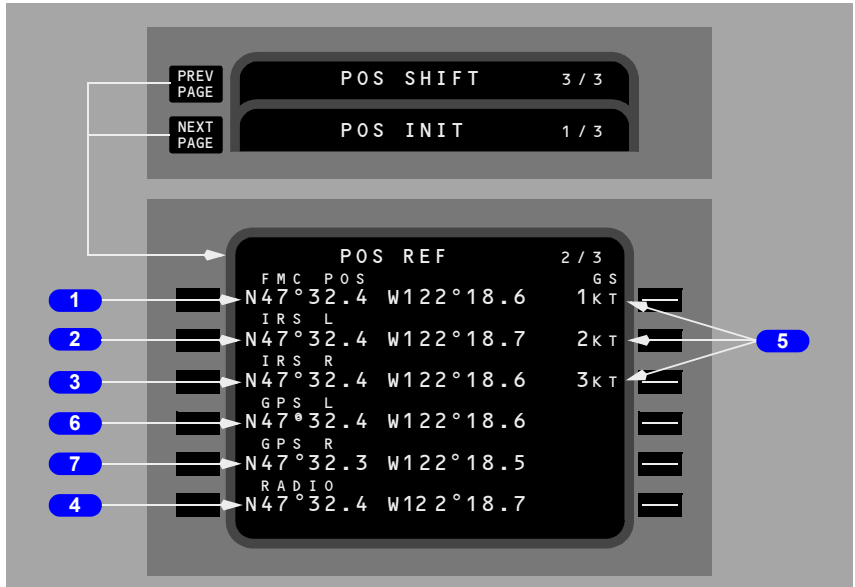

1 FMC Position (FMC POS)

Displays the FMC calculated latitude/longitude.

Blank if FMC position is invalid.

2 IRS L

Displays the latitude/longitude position as determined by the left IRS.

Blank if IRS position is invalid.

3 IRS R

Displays the latitude/longitude position as determined by the right IRS.

Blank if IRS position is invalid.

4 RADIO

Displays the latitude/longitude position as determined by the navigation radios.

Blank if on the ground or if radio position is invalid in flight.

5 Groundspeed (GS)

Displays the ground speed for FMC and IRS.

Blank if ground speed of related system is invalid.

6 GPS L

Displays the latitude/longitude position as determined by the left GPS.

Blank if GPS position is invalid.

7 GPS R

Displays the latitude/longitude position as determined by the right GPS.

Blank if GPS position is invalid.

Route Page 1/X

The route is entered and displayed in air traffic control format.

The first route page displays origin and destination data. Route segments are displayed on subsequent route pages.

Individual portions of the route may be manually entered by the flight crew. An pre-defined route may be loaded using the CO ROUTE line. CO ROUTE entries must correspond to a company defined route in the navigation database.

The route may also be uplinked.

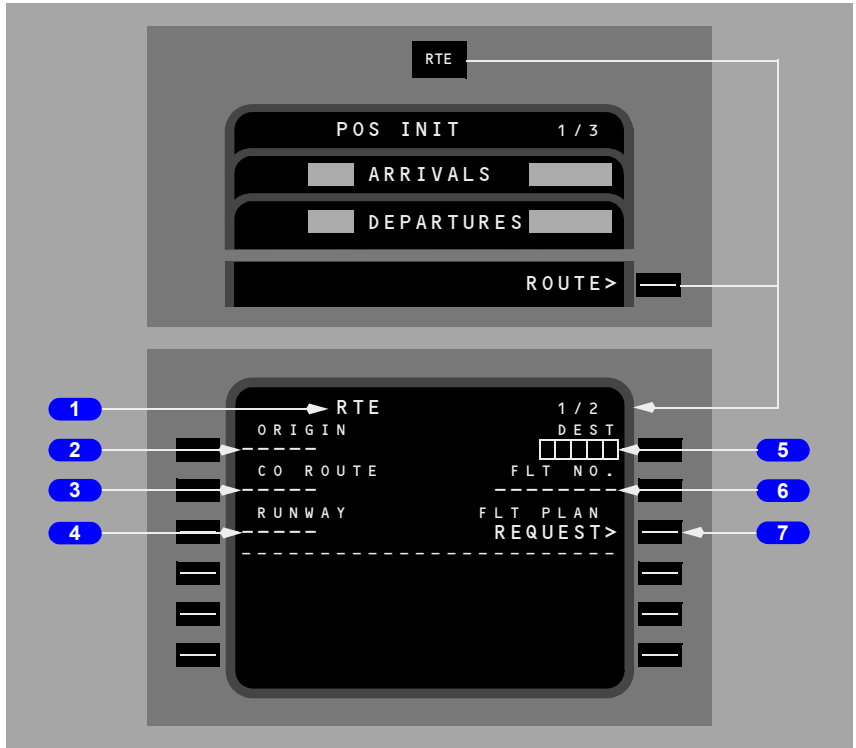

1 Page Title

The word ACT appears to the left of the title when the route has been activated and executed.

The word MOD appears to the left of the normal title when the route is modified and the change is not executed.

Multiple route pages are indicated by the page sequence number to the right of the title.

2 ORIGIN

Enter the ICAO airport identifier for the origin.

An entry is required for route activation.

Valid entries must be in the navigation database.

Entry is allowed for all phases of flight. Entry of a new origin erases the previous route.

New entries on an active route display MOD in the route title.

Enables direct selection of departure and arrival procedures for the origin airport.

Automatically entered as part of a company route.

3 Company Route (CO ROUTE)

A company route can be called from the navigation database by entering the route identifier. The data provided with a company route can include origin and destination airports, departure runway, SID, and STAR, and the route of flight. All company route data is automatically entered when the route identifier is entered.

An entry is optional for activation of the route.

Enter a company route identifier.

Valid entry is any crew entered company route name. If the name is not contained in the NAV database, the scratchpad message NOT IN DATA BASE is displayed.

Entry of a new company route replaces the previous route.

Inflight entry is inhibited for the active route.

4 RUNWAY

Line title does not display until after entry of origin airport.

Enter the desired runway for the origin airport.

An entry is optional for activation of the route.

Entries must be in the navigation database.

New entries on an active route display MOD in the route title.

Can be entered from the DEPARTURES page.

Entry is deleted upon takeoff.

5 Destination (DEST)

Enter the ICAO airport identifier for the destination of the route.

An entry is required for route activation.

Entries must be in the navigation database.

737 Flight Crew Operations Manual

New entries on an active route display MOD in the route title.

Enables direct selection of arrival procedures for the destination airport.

Automatically entered as part of a company route.

Entry and execution of a new destination clears any runway and runway dependent approach procedure of the previous destination. If the active leg is part of the affected procedure, then all subsequent (inactive) legs are cleared.

6 Flight Number (FLT NO.)

Enter the company flight number.

Entry is optional for activation of the route.

Limited to 8 characters.

Crew entered.

Flight number is included in the PROGRESS page title.

As installed:

Transponder transmits flight number to ATC.

7 FLT PLAN REQUEST

Push – transmits a data link request for a flight plan route uplink

Route Pages 1/X and 2/X with Data Entries

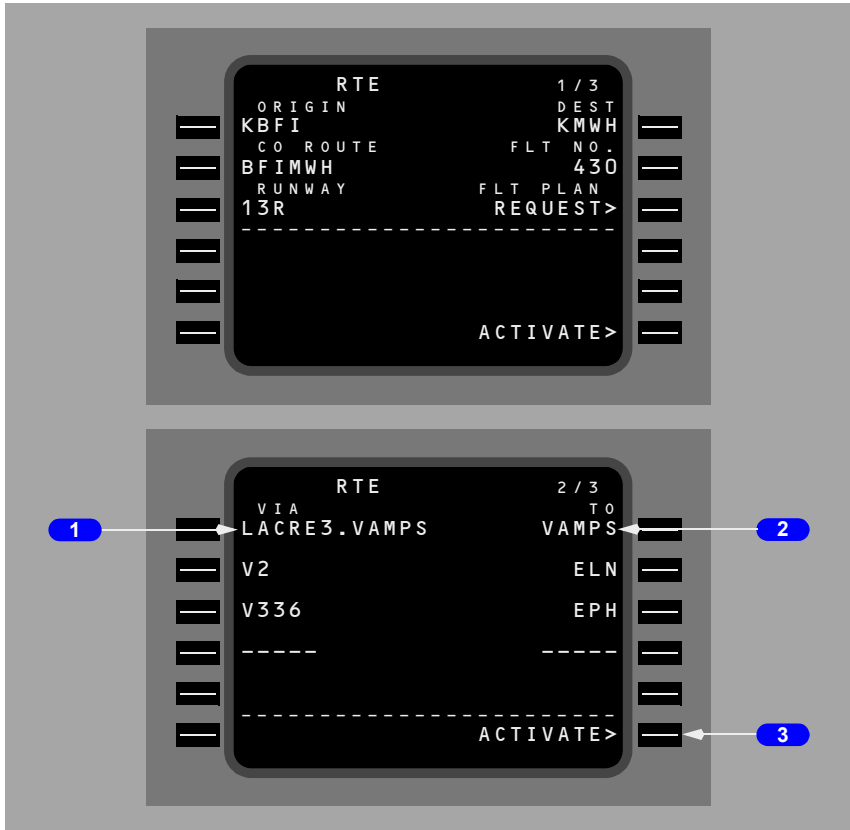

1 VIA

The VIA column displays the route segment to the waypoint or termination displayed in the TO column. Enter the path which describes the route segment between the previous waypoint and the segment termination.

Enter an airway in the VIA column and box prompts are displayed in the TO column if the previous TO line contains a waypoint on the airway.

Valid entries can also include procedures or DIRECT. Procedures are normally entered through selections on DEPARTURES and ARRIVALS pages. DIRECT is normally entered as a result of entering a TO waypoint first.

Valid airways must:

- contain the fix entered in the TO waypoint, and
- contain the previous TO waypoint, or

Dashed prompts change to DIRECT if the TO waypoint is entered first.

737 Flight Crew Operations Manual

Dash prompts appear for the first VIA beyond the end of the route.

Invalid VIA entries display the scratchpad entry INVALID ENTRY.

Invalid VIA entries are:

- airways and company routes which do not contain the TO waypoint of the previous line
- airways or company routes that are not in the navigation database.

When entering airways, the beginning and ending waypoints determine if the entry is valid. The route segment must contain the waypoint entered in the TO position. The TO waypoint of the previous route segment must be the same as the beginning point of the current route segment, or a route discontinuity is created between the segments.

Entry of a SID or transition automatically enters the VIA and TO data for the route segments of the SID. A SID automatically links to the next route segment when the final SID waypoint is part of the route segment.

LACRE3.VAMPS is an example of a SID selection made on the DEPARTURES page.

V2 is an example of airway entry.

2 TO

Enter the end point of the route segment specified by the VIA entry.

Entry of a waypoint in the TO column without first entering a VIA airway displays DIRECT in the VIA column.

Box prompts indicate that an entry is required.

Valid waypoint entries for a DIRECT route segment are any valid waypoint, fix, navaid, airport, or runway.

Valid waypoint entries for airways are waypoints or fixes on the airway.

Dash prompts appear on the first TO waypoint following the end of the route.

3 ACTIVATE

Pushing the ACTIVATE key arms the route for execution as the active route. When the EXEC key is pushed, the route becomes the active route and the ACTIVATE prompt is replaced with the next required preflight page prompt.

Push – prepares the selected route for execution as the active route.

Activation of a route is required for completion of the preflight.

Displayed on inactive route pages.

After route activation, the ACTIVATE prompt is replaced by:

- PERF INIT, when the required performance data is incomplete, or
- TAKEOFF when the required performance data is complete.

Additional Route Page Prompts for an Activated Route

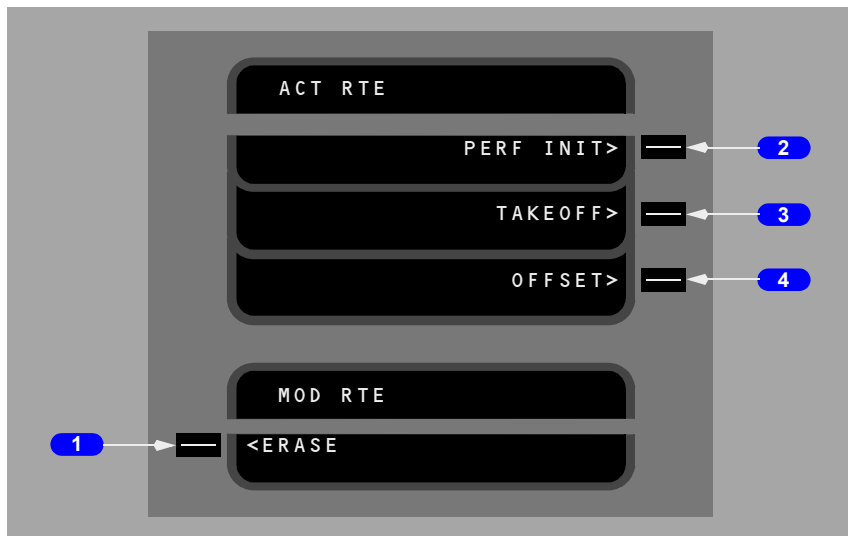

1 ERASE

Push – removes all pending modifications.

Displayed only during modifications.

2 Performance Initialization (PERF INIT)

Push – displays PERF INIT page.

Displayed only on the ground when required entries on the PERF INIT page are incomplete.

3 TAKEOFF

Push – displays TAKEOFF REF page 1/2.

Displayed only on the ground when all required entries on the PERF INIT page are complete.

4 OFFSET

Push – displays LATERAL OFFSET page.

Displayed only in flight.

Departure/Arrival Index Page

The departure and arrival index page is used to select the departure or arrival page for the origin and destination airports for each route. The index also allows reference to departure or arrival information for any other airport in the navigation database.

Departure and arrival prompts are available for the origin airport. Destination airports have only arrival prompts.

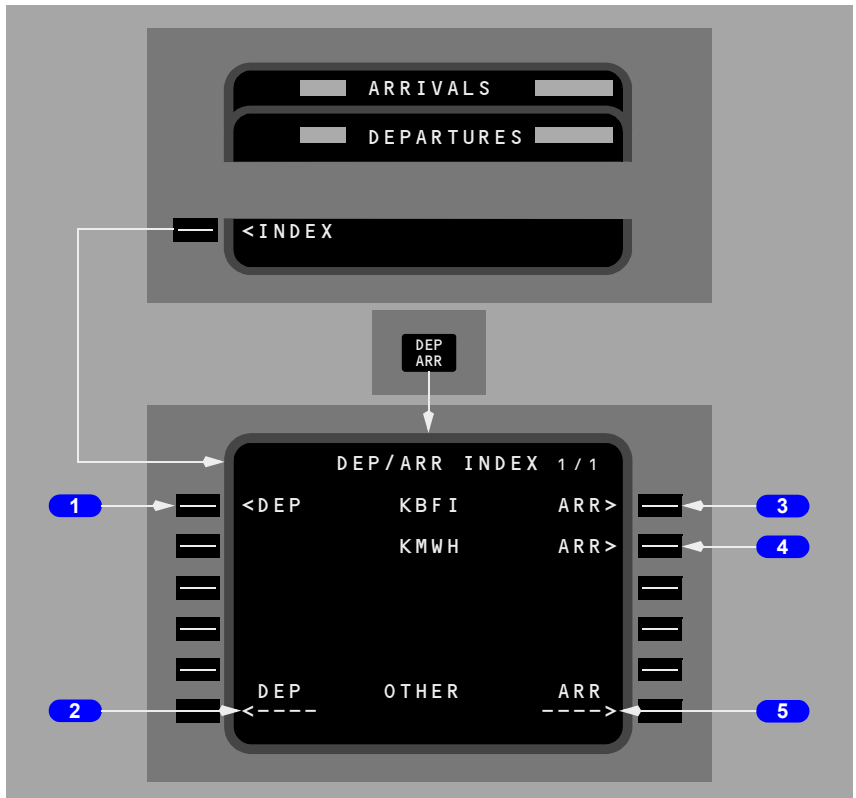

1 Departure (DEP) – Origin

Push – displays the departure page for origin airport.

2 Departure (DEP) – OTHER

Displays the departure page for the airport entered into this line through the scratchpad.

DEP prompt for OTHER allows display of departure information about airports that are not an origin or destination. The displayed information can be viewed but cannot be selected, because the airport is not on the route.

3 Arrival (ARR) – Origin

Push – displays the arrival page for origin airport. Origin airport arrivals selection is used during a turn-back situation.

4 Arrival (ARR) – Destination

Push – displays the arrival page for destination airport.

5 Arrival (ARR) – OTHER

Displays the arrival page for the airport entered into this line through the scratchpad.

ARR prompt for OTHER allows display of arrival information about airports that are not an origin or destination. The displayed information can be viewed but cannot be selected, because the airport is not on the route.

Departures Page

The departures page is used to select the departure runway, SID, and transition for the route origin airport.

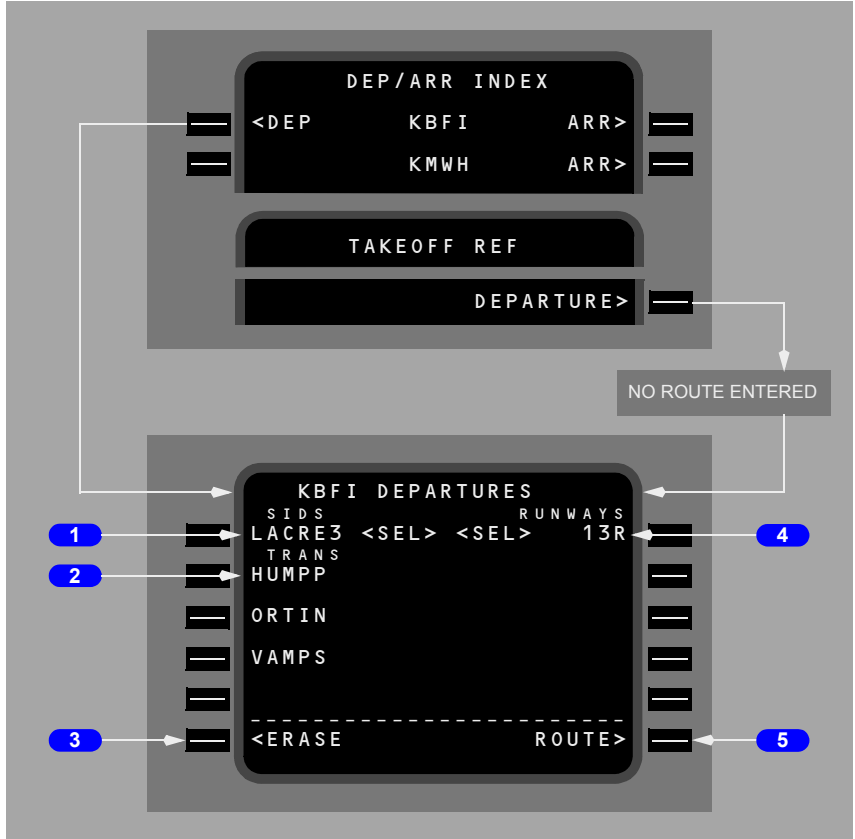

1 Standard Instrument Departures (SIDS)

Displays SIDS for the airport and runway selections.

Without the selection of a runway on the RTE page, the initial display contains all of the information for the airport runways and SIDS. As selections are made, incompatible options are removed. SID transitions are displayed after a SID is selected.

2 Transitions (TRANS)

Displays transitions compatible with the selected SID.

3 ERASE/INDEX

ERASE is displayed when a route modification is pending.

Push – removes route modifications that are not executed and restores the original route.

INDEX is displayed when no route modification is pending.

Push – displays the DEP/ARR INDEX page.

4 RUNWAYS

Displays a list of runways for the selected airport.

The runway selected on the RTE page is displayed as <SEL> or <ACT> when this page is displayed.

5 ROUTE

Push – displays the RTE page.

Selecting Options

Selecting an option displays <SEL> inboard of the option, and a route modification is created. When the modification is executed, the <SEL> becomes <ACT>. Leaving the page and returning displays all options and the <SEL> or <ACT> prompts.

Performance Initialization Page

The performance initialization page allows the entry of airplane and route data to initialize performance calculations. This information is required for VNAV calculations.

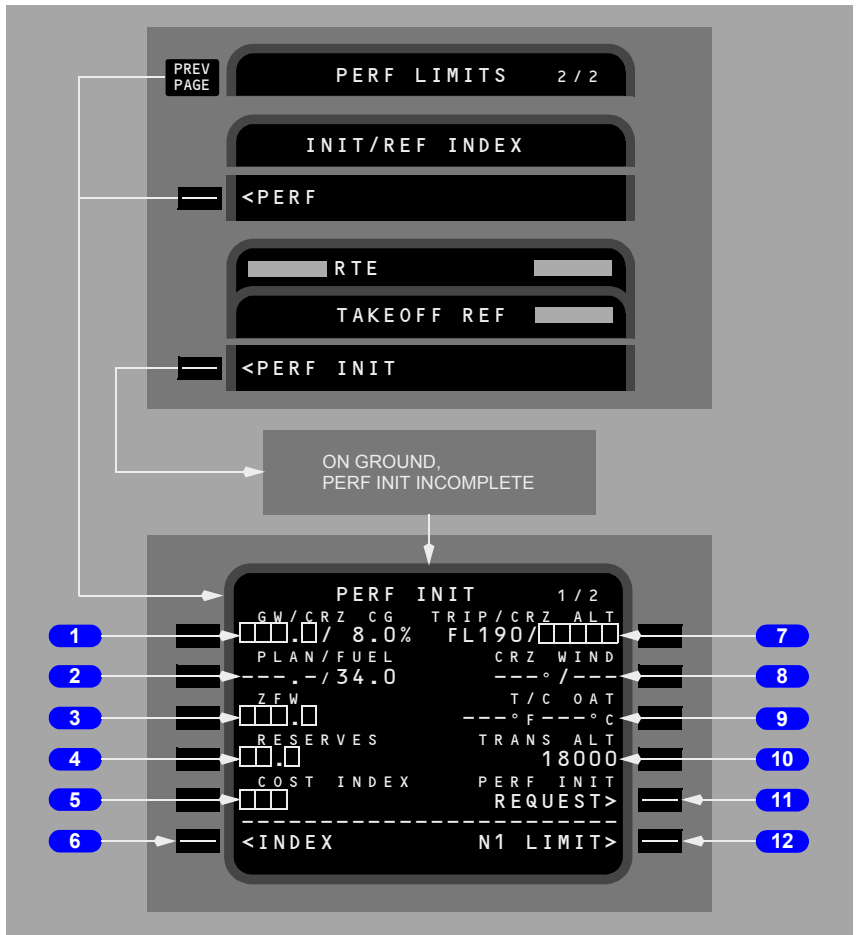

1 Gross Weight/Cruise Center of Gravity (GW/ CRZ CG)

Airplane gross weight is required. The entry can be made by the flight crew or automatically calculated by the FMC, following entry of zero fuel weight.

Enter airplane gross weight.

Valid entries are xxx or xxx.x.

Automatically displays calculated weight when zero fuel weight is entered first.

Displays default or manually entered cruise CG. Entry of actual cruise CG may increase maximum altitude capability.

2 PLAN/FUEL

Fuel on board is automatically displayed as received from the airplane fuel quantity indication system.

PLAN entry allows fuel predictions before actual fuel is known. Entry is blanked with flaps extended or in flight.

In flight, when the FMC is not receiving the required fuel data, the CDU displays dashes and allows manual entry of fuel weight. After manual entry, MAN (manual) appears next to the fuel weight. Manual entry of fuel weight should continue approximately every 30 minutes for the remainder of the flight to keep gross weight current.

3 Zero Fuel Weight (ZFW)

Airplane zero fuel weight is required. Normally the ZFW is entered from the airplane dispatch papers and the FMC calculates the airplane gross weight.

Enter the airplane zero fuel weight.

Valid entry is xxx or xxx.x.

Calculated zero fuel weight is automatically displayed if airplane gross weight is entered first and fuel on board is valid.

4 RESERVES

Enter fuel reserves for the route.

Entry is required to complete the preflight.

Valid entry is xx or xx.x.

5 COST INDEX

The cost index is used to calculate ECON climb and cruise speeds. The value reflects the relative impacts on overall trip cost of fuel cost as compared to other direct hourly operating costs.

Enter the cost index for ECON calculations.

Entry is required to enable use of VNAV mode.

Valid entries are 0 to 500. 0 causes the ECON speed to be MAX RANGE; 500 results in a minimum time flight.

737 Flight Crew Operations Manual

Entry of a company route on RTE page causes any company stored value of cost index to be automatically displayed. A manual entry has priority.

6 INDEX

Push – displays the INIT/REF INDEX page.

7 Trip/Cruise Altitude (TRIP/CRZ ALT)

Trip altitude is automatically computed and displayed whenever entries have been made for the ORIGIN, DEST, GROSS WT, and COST INDEX. Otherwise, the field is blank.

Trip altitude is the predicted minimum cost altitude determined by operator constraints. Provides crew a reference for selecting a planned cruise altitude.

Cruise altitude is required.

Enter the cruise altitude for the route.

Automatically displays this cruise altitude on the CLB, CRZ, and RTE Legs pages.

8 Cruise Wind (CRZ WIND)

Cruise wind entry provides input to optimize FMC calculations.

Enter the forecast cruise wind.

Entry is propagated onto the RTE DATA page.

If no entry made, the FMC assumes zero wind for preflight predictions.

9 Top of Climb Outside Air Temperature (T/C OAT)

T/C OAT entry provides input to optimize FMC calculations.

Entry causes ISA DEV to be computed and displayed.

Enter top of climb OAT.

If no entry made, FMC assumes ISA value.

10 Transition Altitude (TRANS ALT)

Displays 18,000 feet at FMC power up.

Changes automatically after selecting a departure procedure with a different transition altitude.

Manual entry has priority.

11 PERF INIT REQUEST

Push – transmits a data link request for a PERF INIT uplink

12 N1 LIMIT

Push – displays the N1 LIMIT page.

Performance Limits Page

The performance limits page allows the entry of performance limits affecting RTA and ECON calculations.

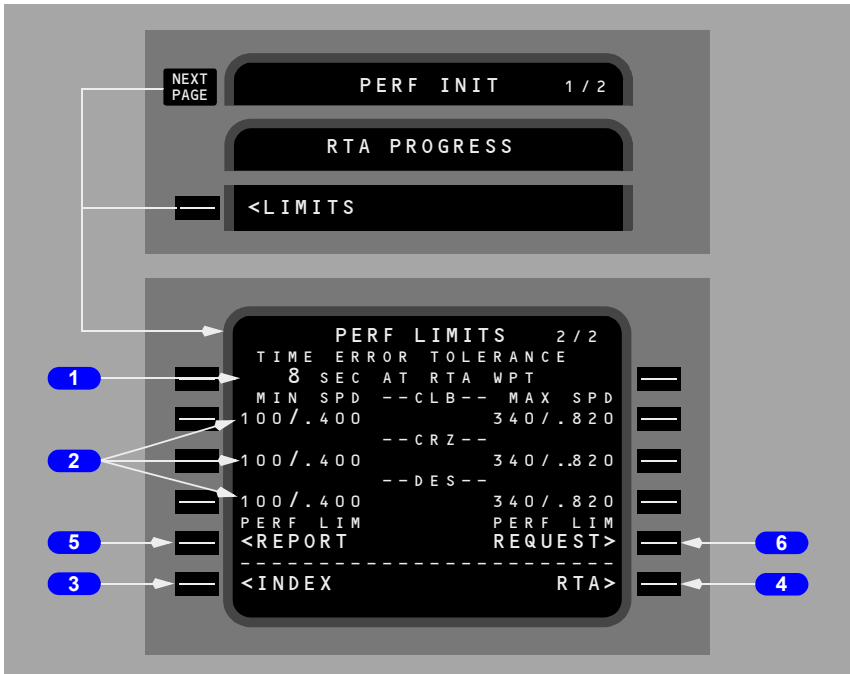

1 TIME ERROR TOLERANCE

Used during RTA calculations to establish a boundary on computed speeds.

Valid entry range is from 5 to 30 seconds.

Default value is 30 seconds and is displayed in small font.

2 Minimum Speed/Maximum Speed (MIN SPD/MAX SPD)

Establishes lower and upper speed limits for each phase of flight.

Default is 100/.400 for lower limit and 340/.820 for upper limit. Default values are displayed in small font and entered values are displayed in large font.

Either CAS or Mach can be entered.

Limits both RTA and ECON modes in flight.

737 Flight Crew Operations Manual

3 INDEX

Push – selects INIT /REF INDEX page.

4 Required Time of Arrival (RTA)

Push – selects RTA PROGRESS page.

5 PERF LIM REPORT

Push – transmits displayed performance limits to ground station.

6 PERF LIM REQUEST

Push – transmits a data link request for a performance limits uplink.

N1 LIMIT Page - Preflight

This section describes the preflight version of the N1 LIMIT page. See the FMC Takeoff and Climb section for a description of the in-flight version of the N1 LIMIT page.

The N1 LIMIT page is used during preflight to manage takeoff and climb thrust. Temperature data is entered, allowing the FMC to make N1 computations for normal or reduced thrust takeoff. Fixed takeoff and climb thrust derates may be selected.

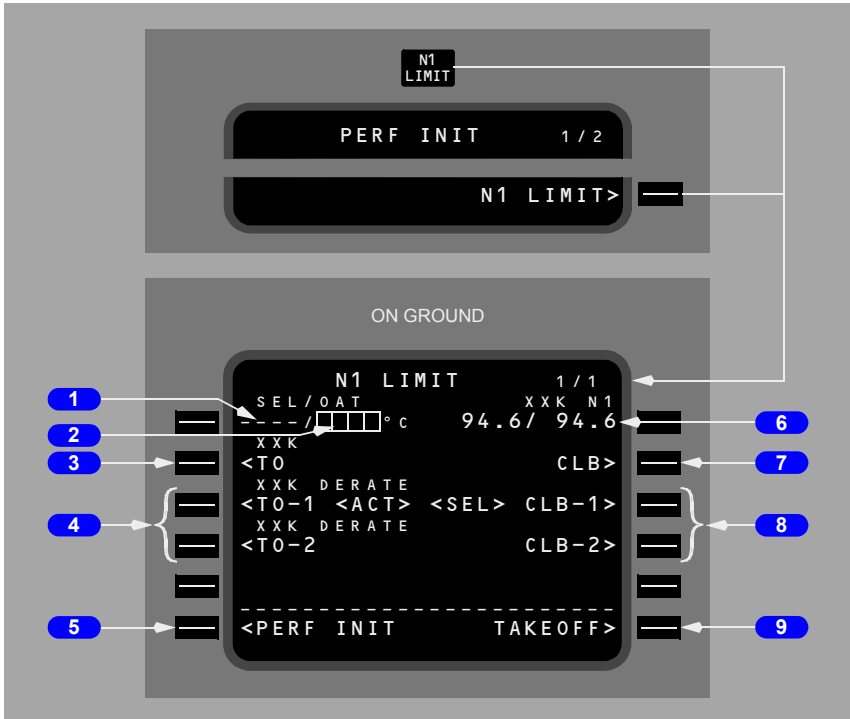

1 Selected Temperature (SEL)

Entry of an assumed temperature calculates a reduced thrust takeoff N1.

Entry can be made in degrees C or degrees F.

Maximum allowable entry is 70 degrees C (158 degrees F). The FMC, however, will limit the N1 to 25% takeoff reduction.

2 Outside Air Temperature (OAT)

Manual entry of actual takeoff OAT is displayed in large-sized characters and is used by the FMC to calculate the takeoff N1 limits.

Entry can be made in degrees C or degrees F.

3 Takeoff Thrust Limit (TO XXX)

Push – selects full rated takeoff thrust limit.

Selection of TO automatically selects CLB thrust.

Data line title displays full rated thrust. Typical line titles display as “24K” or “22K.”

Selection of a new rating after V speeds are selected on the TAKEOFF REF page causes the V speeds to display in small font, and the NO VSPD flag to show on the airspeed indication.

4 Takeoff Derates (TO-1 and TO-2)

Push – selects the associated takeoff thrust limit.

Takeoff data uplink may automatically select a thrust derate.

Data line title displays the associated reduced thrust rating. Typical line titles display as “22K DERATE” or “20K DERATE”

Normally, selecting TO-1 automatically arms CLB-1 and selecting TO-2 automatically arms CLB-2.

Note: If a reduced thrust takeoff has been specified, then either CLB-1 or CLB-2 may be automatically specified if required to avoid a climb N1 value greater than the specified reduced thrust takeoff N1.

Selection of a new rating after V speeds are selected on the TAKEOFF REF page causes the V speeds to display in small font, and the NO VSPD flag to show on the airspeed indication.

5 PERF INIT

Push – displays the PERF INIT page.

6 Takeoff N1 (XXX N1)

Displays the FMC computed N1 for takeoff

Data line title displays full rated thrust or selected takeoff derate thrust. Typical line titles display as “24K N1” or “22K N1”

Data line title changes to RED XXK N1 when an assumed temperature (SEL TEMP) entry results in a reduced N1 value. If a SEL TEMP and a DERATE are both selected the data line title will change to "RED XXK N1," and the effect on thrust will be additive. The Reference N1 bugs will still display full rated or selected takeoff derate thrust N1 values.

7 Climb (CLB)

Push – selects full rated climb thrust limit.

Climb thrust is automatically selected at the thrust reduction point on the TAKEOFF REF page 2.

8 Reduced Climb (CLB-1 and CLB-2)

Push – selects the associated reduced thrust climb mode.

CLB-1 provides a climb limit reduced by 3% N1 (approximately 10% thrust).

CLB-2 provides a climb limit reduced by 6% N1 (approximately 20% thrust).

Deletion results in the selection of CLB thrust.

Manual selection of a climb thrust rating overrides the automatic selection.

Takeoff data uplink may automatically select a thrust derate.

9 TAKEOFF

Push – displays the TAKEOFF REF page.

Selecting Takeoff Thrust

Selecting the maximum takeoff thrust or a derate displays <ACT> inboard of the option. The FMC automatically selects the highest climb thrust available which would not result in a throttle increase, when the aircraft transitions from takeoff to climb. <SEL> is displayed inboard of the selected climb N1 limit.

Takeoff Reference Page 1/2

The takeoff reference page allows the crew to manage takeoff performance.

Takeoff flap setting and V speeds are entered and verified. Thrust limits, takeoff position, CG, and trim can be verified or changed.

Preflight pages are selectively displayed to indicate preflight status whenever required entries on those pages are incomplete. Takeoff reference page entries finish the normal preflight. V speeds should be set before completion. FMC position can be updated prior to takeoff.

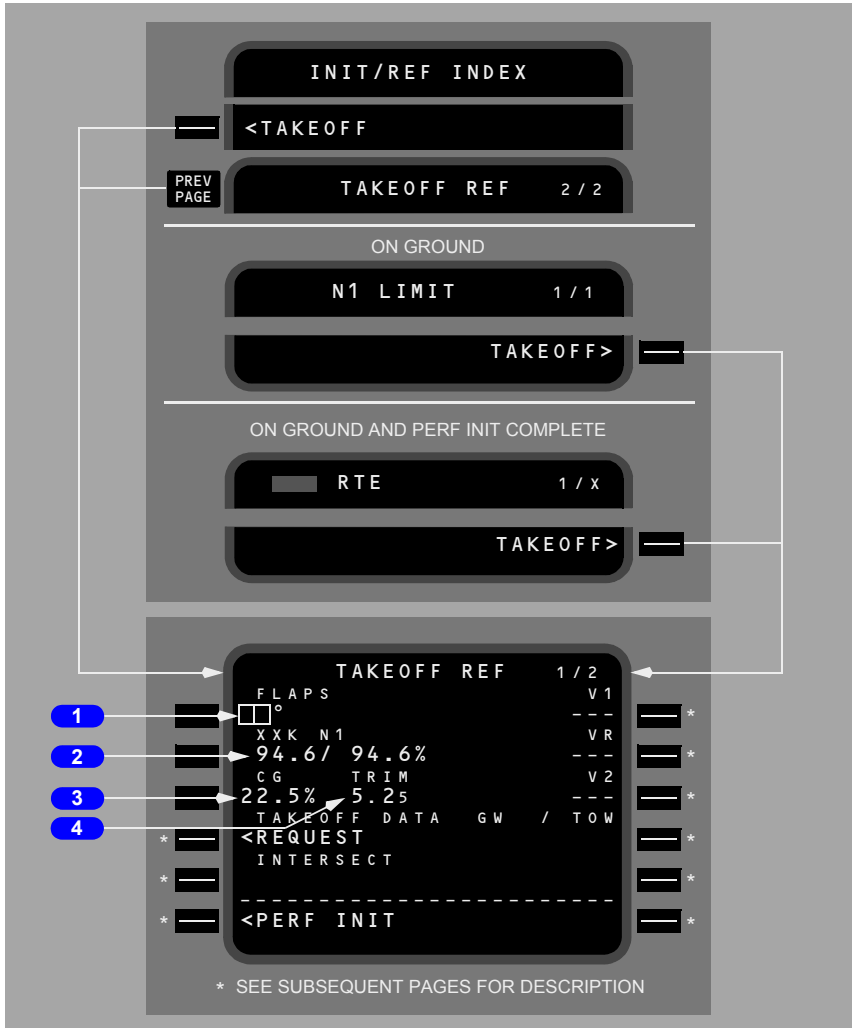

1 FLAPS

Enter takeoff flaps setting. Manual entry of 1, 5, 10, 15, or 25 allowed.

2 Takeoff N1 (XXK N1)

Displays the FMC computed N1 for takeoff.

Data line title displays full rated thrust or selected takeoff derate thrust. Typical line titles display as "24K N1" or "22K N1."

Data line title changes to RED XXK N1 when an assumed temperature (SEL TEMP) entry results in a reduced N1 value. If a SEL TEMP and a DERATE are both selected the data line title will change to "RED XXK N1," and the effect on thrust will be additive. The Reference N1 bugs will still display full rated or selected takeoff derate thrust N1 values.

3 Center of Gravity (CG)

Initial display is dashes.

After CG is entered, the FMC calculates and displays stabilizer takeoff trim settings.

4 TRIM

Displays stabilizer takeoff trim setting.

Display is blank unless FLAPS and CG are entered.

Company Data Link



737 Flight Crew Operations Manual

1 TAKEOFF DATA REQUEST

Push – transmits a data link request for a takeoff data uplink. Resulting TAKEOFF REF uplink may contain takeoff data for up to 6 runways, which are stored in FMC uplink memory.

2 Intersection (INTERSECT)

Displays active runway.

An intersection may be entered. Valid entries are 1 to 3 alphanumeric.

If an intersection is entered and TAKEOFF DATA REQUEST is made, the runway/intersection pair is included in the request downlink.

If the displayed runway or runway/intersection pair matches a runway or runway/intersection pair in FMC uplink memory, the associated TAKEOFF REF UPLINK is annunciated for flight crew ACCEPT/REJECT.

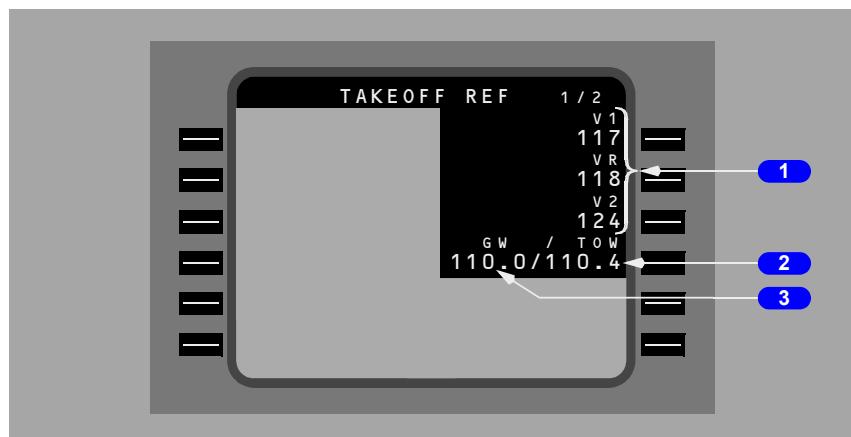
V Speed Data

1 V Speeds (V1, VR, and V2)

Crew calculated V speeds may be entered and displayed for reference.

V speeds may be uplinked.

Large font V speeds are displayed on the airspeed indication.

2 Takeoff Weight (TOW)

Displays gross weight the uplink V speeds are based on.

Blank if there are no uplinked V speeds in the column above.

3 Gross Weight (GW)

Displays current gross weight.

Change of Performance Data After V Speed Entry

V speeds should be entered on the TAKEOFF REF page as a final step of FMC preflight. If V speeds are entered and then performance data (for example, OAT or takeoff thrust) is subsequently changed, the FMC automatically removes the previously entered V speeds and the NO VSPD flag shows on the airspeed indication.

In addition, the scratchpad message VERIFY TAKEOFF SPEEDS displays if any of the following items are changed after V speeds have been entered:

- gross weight
- zero fuel weight
- plan fuel.

The previously entered V speeds are displayed in small font on the TAKEOFF REF page.

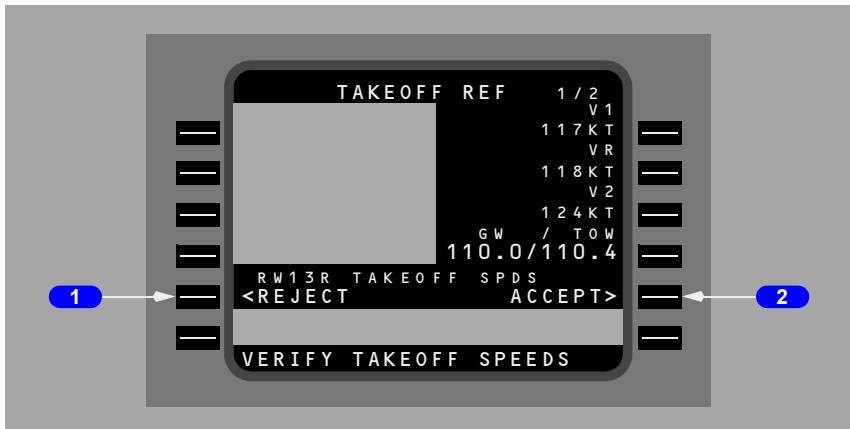

1 REJECT

Displayed if V speeds have been entered and airplane gross weight, ZFW, or plan fuel has been changed.

Push – causes the now small font takeoff speeds to disappear.

2 ACCEPT

Displayed if V speeds have been entered and airplane gross weight, ZFW, or plan fuel has been changed.

Push – changes the small font takeoff speeds to large font.

Preflight Status

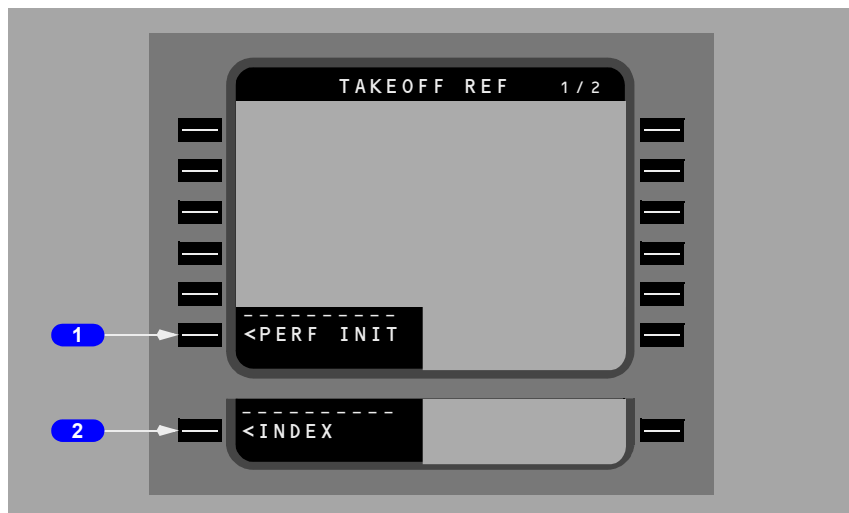

1 Preflight Incomplete

When required preflight entries are not complete, the related page title displays

- POS INIT – IRS position not entered or invalid
- PERF INIT – required performance data not entered or executed
- ROUTE – required RTE page data not entered
- DEPARTURE – runway or route data not entered on the RTE page.
- N1 LIMIT – OAT not entered.

Push – Displays associated page.

2 Preflight Complete (INDEX)

When the required preflight entries are complete, the index prompt is displayed below the takeoff reference page data. When required preflight entries are not complete, the related page title replaces the INDEX prompt.

Displayed following completion of required preflight entries on the POS INIT, RTE, and PERF INIT pages.

Push – Displays INIT REF INDEX page.

FMC Takeoff Position Update

YA373 - YA377, YC202 - YC207, YE324 - YE326



YA371, YA372, YC201, YE321 - YE323



1 Takeoff Shift (TO SHIFT)

YA373 - YA377, YC202 - YC207, YE324 - YE326

Automatically displays the departure runway from the route page.

If a takeoff shift distance is not entered and GPS UPDATE is OFF, the FMC updates to the runway threshold when TO/GA is pushed.

If a takeoff shift distance is entered and GPS UPDATE is OFF, the FMC updates to the threshold of the departure runway plus the entered distance when the TO/GA switch is pushed.

TO/GA position update inhibited if GPS UPDATE is ON.

Following TO/GA update, the runway identifier and any entered shift value are highlighted in reverse video characters.

737 Flight Crew Operations Manual

To remove a TO SHIFT entry, reselect RWY on the RTE page.

1 Runway Remaining (RWY REMAIN)**YA371, YA372, YC201, YE321 - YE323**

Automatically displays the departure runway from the RTE page.

If a runway remaining distance is not entered and GPS UPDATE is OFF, the FMC updates to the runway threshold when TO/GA is pushed.

If a runway remaining distance is entered and GPS UPDATE is OFF, the FMC updates to the runway length remaining when the TO/GA switch is pushed.

TO/GA position update inhibited if GPS UPDATE is ON.

Following TO/GA update, the runway identifier and any entered shift value are highlighted in reverse video characters.

To remove a RWY REMAIN entry, reselect RWY on RTE page.

Takeoff Reference Page 2/2

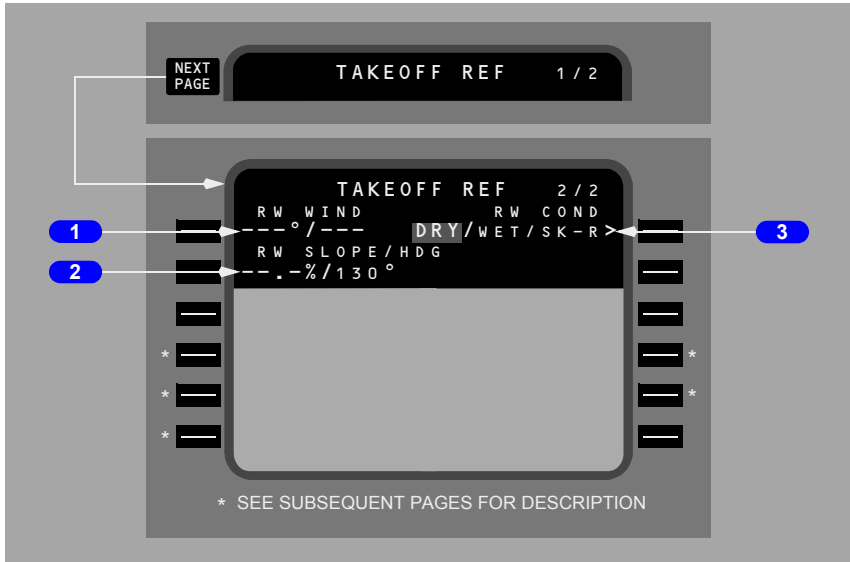

1 Runway Wind (RW WIND)

Enter surface wind direction and speed.

Entry is optional for preflight completion.

2 Runway Slope/Heading (RW SLOPE/HDG)

Enter runway slope.

Entry is optional for preflight completion.

Valid runway slope is U or + for up or D or – for down followed by slope in percent gradient.

HDG displays runway heading for origin airport.

3 Runway Condition (RWY COND)

Active runway condition is highlighted:

- DRY – Dry runway computations
- WET – Wet runway computations
- SK–R – Skid resistant runway computations

Default condition is DRY.

737 Flight Crew Operations Manual

The runway condition can be viewed by flight crew and shows under what conditions the uplinked V Speeds have been computed for. The runway condition is displayed for reference only and cannot be changed by the flight crew.

Takeoff Thrust

YA371 - YA374, YC201 - YC206, YE321 - YE326

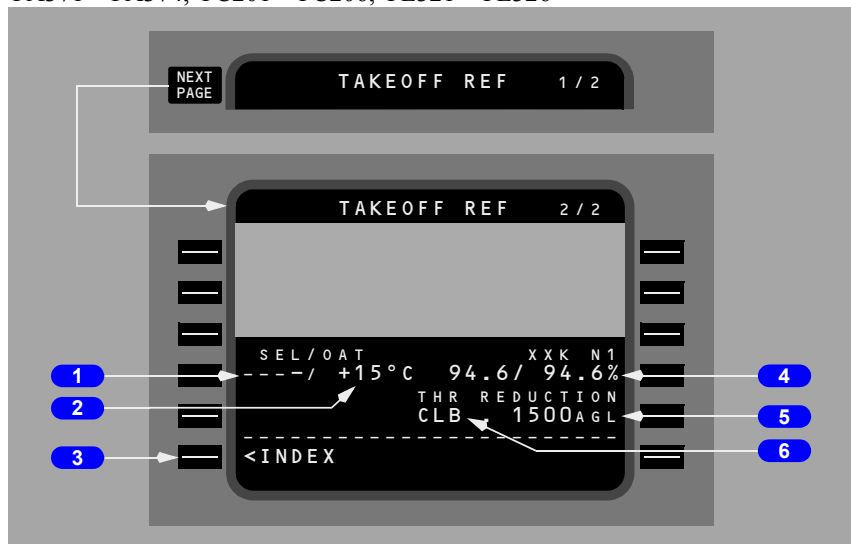

YA375 - YA377, YC207

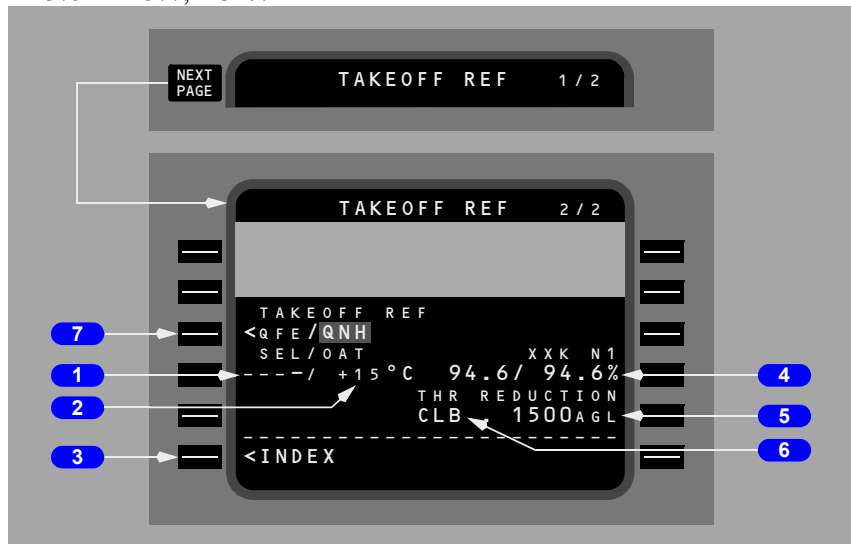

1 Selected Temperature (SEL)

Entry of an assumed temperature calculates a reduced thrust takeoff N1.

Entry can be made in degrees C or degrees F.

Maximum allowable entry is 70 degrees C (158 degrees F). The FMC, however, will limit the N1 to 25% takeoff reduction.

Repeats data shown on the preflight version of the N1 LIMIT page.

2 Outside Air Temperature (OAT)

Manual entry of actual takeoff OAT is used by the FMC to calculate the takeoff N1 limits.

Entry can be made in degrees C or degrees F.

3 INDEX

Push – displays the INIT/REF INDEX page.

4 Takeoff N1 (XXK N1)

Displays the FMC computed N1 for takeoff.

Data line title displays full rated thrust or selected takeoff derate thrust. Typical line titles display as “24K N1” or “22K N1.”

Data line title changes to RED XXK N1 when an assumed temperature (SEL TEMP) entry results in a reduced N1 value. The Reference N1 bugs will still display full rated or selected takeoff derate thrust N1 values.

Repeats the same information shown on TAKEOFF REF page 1 and the preflight version of the N1 LIMIT page.

5 Thrust Reduction (THR REDUCTION)

Altitude above origin airport elevation at which the autothrottle reduces from takeoff N1 to climb N1.

The default value is determined by the airline and is stored in the model/engine database. The default is displayed in small font.

Manual entries allowed on the ground. Entries must be between 800 to 9,999 feet and are displayed in large font.

Deletion of a manual entry returns the display to the default value.

6 Selected Climb Rating

Displays the climb rating that will be set at the THR REDUCTION altitude, as selected on the preflight version of the N1 LIMIT page.

7 Takeoff Reference (TAKEOFF REF)**YA375 - YA377, YC207**

Push – Toggles altimeter reference between QFE and QNH.

Default is QNH.

Resets to QNH at flight complete.

Reflects LANDING REF selection on APPROACH REF page.

Active altimeter reference is highlighted.

During preflight with QFE selected, the PFD altitude indications show zero feet at the departure runway threshold. The PFD altitude indication background colors change to green.

If QFE is the current altimeter reference, and the EFIS control panel STD switch is pushed, The takeoff reference automatically toggles to QNH.

Menu Page

The menu page is selected with the MENU key or is automatically displayed when the currently active subsystem fails or on initial power up if the FMC system is not detected.

The menu page displays subsystems (ACARS, DFDAU, etc.) that require control/display functions through the MCDU and provides a means to temporarily access to these subsystems. The active system is indicated by <ACT> displayed next to the system title. A subsystem that requires use of the CDU displays a request message <REQ> next to the subsystem title. The FMC system or a requesting subsystem is accessed by using the line select key next to the title. The FMC can be reselected by selecting the FMC prompt on the MENU page or selecting any mode key (INIT/REF, RTE, etc.). A subsystem can be temporarily placed on hold <HLD> by selecting the subsystem <XXXXXX HOLD> line select key returning the CDU display to the currently active FMC page (<XXXXXX represents the system name). While the subsystem is on hold the MCDU CALL light is illuminated. To reselect the subsystem on hold, push the subsystem line select key again. When a subsystem is placed on hold a <XXXXXX LOGOFF prompt appears to allow for release of the subsystem being held. No more than one subsystem can be selected at a time. If an attempt is made to select more than one subsystem, a FIRST LOGOFF <XXXXXX prompt is displayed as a reminder to logoff the currently active subsystem.

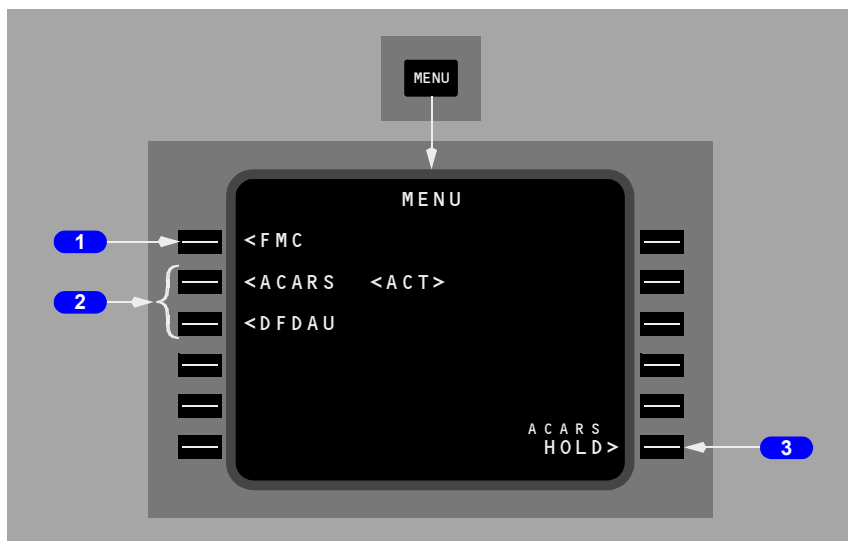

737 Flight Crew Operations Manual

1 FMC

Push – selects FMC as the system for which the MCDU will be active in providing control/display function.

2 Other Aircraft Subsystems (typical)

Push – selects the subsystem for which the MCDU will be active in providing control/display function.

3 XXXXXX HOLD/LOGOFF

Push - places active subsystem on hold or logs off subsystem and returns control to the FMC.



Intentionally
Blank



Introduction

The FMC takeoff phase begins with the selection of takeoff/go-around (TO/GA). Preparation for this phase begins in the preflight phase and includes entry of the TAKEOFF REF page data.

The takeoff phase automatically changes to the climb phase when climb thrust is selected. The climb phase continues to the top of climb point, where the cruise phase begins.

During these phases, the following pages are normally used:

- TAKEOFF REF page – to make last minute changes to the departure runway
- DEPARTURES page – to make last minute changes to the SID
- CLIMB page – to modify climb parameters and monitor airplane climb performance
- RTE LEGS page – to modify the route and monitor route progress
- PROGRESS page – to monitor the overall progress of the flight
- N1 LIMIT page – to select alternate climb thrust limits
- DEP/ARR INDEX page – to select an approach during a turn-back.

Takeoff Phase

When last minute changes are made to the departure runway and SID, the TAKEOFF REF and DEPARTURES pages must be modified to agree. The modifications are performed the same as during preflight.

With correct takeoff parameters, the FMC commands the selected takeoff thrust when the TO/GA switch is pushed. During the takeoff roll, the autothrottle commands the thrust and the FMC commands acceleration to between V2+15 and V2+25 knots.

LNAV can be selected prior to takeoff. Prior to 50 feet radio altitude, roll command is wings level. At 50 feet radio altitude, if within engagement criteria, LNAV engages and provides roll commands to fly the route leg. VNAV may be engaged to control the climb profile.

Note: For LNAV to be engaged on the ground, the departure runway must be selected and the course, to the first waypoint, must be within 5 degrees of the runway heading.

Climb Phase

VNAV commands acceleration to:

- 250 knots
- waypoint speed constraints, or
- the speed restriction associated with the origin airport, whichever is more restrictive.

At the climb thrust reduction point, the FMC commands a reduction to the selected climb thrust. Passing 10,000 feet, VNAV commands an acceleration to the economy climb speed, which is maintained until entering the cruise phase. Waypoint speed constraints take priority if slower than target speed.

During the climb, VNAV complies with the LEGS page waypoint altitude and speed constraints. A temporary level-off for a crossing altitude restriction is accomplished at the current commanded speed.

When the climb speed profile causes an anticipated violation of a waypoint altitude constraint, the FMC displays the CDU scratchpad message UNABLE NEXT ALTITUDE. A different speed profile that provides a steeper climb angle must be manually selected.

If a CLB 1 or CLB 2 derate is selected, the derate is maintained for the initial part of the climb. Thrust eventually increases to maximum climb thrust by 15,000 feet.

Climb Page

The climb page is used to evaluate, monitor, and modify the climb path. The data on the climb page comes from preflight entries made on the route and performance pages.

The climb page is automatically selected by pushing the CLB function key on the ground and during takeoff and climb. The TAKEOFF REF page automatically transitions to the climb page after takeoff.

The FMC climb mode can be economy or fixed speed. In either mode, similar data is displayed on the page.

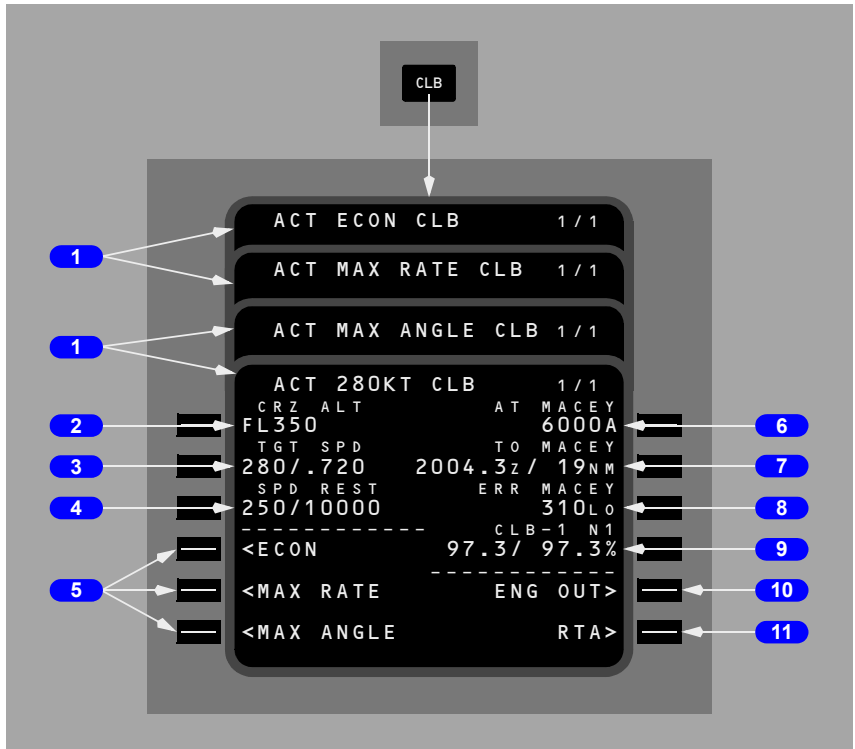

1 Page Title

The page title displays the type of climb. Normally, the title displays ECON for the economy climb mode. Fixed speed climbs modify the title.

ECON indicates the speed is based on a cost index.

MAX RATE indicates the speed is based on the maximum altitude over the shortest period of time.

MAX ANGLE indicates the speed is based on the maximum altitude over the shortest horizontal distance.

Fixed climb speeds display XXXKT for a fixed CAS climb speed or M.XXX for a fixed Mach climb speed profile. Reasons for fixed speeds are:

- takeoff/climb acceleration segment constraints
- waypoint speed constraints
- an altitude constraint associated with a speed constraint
- a speed restriction
- a crew entered speed.

Displays ACT when the climb phase is active.

2 Cruise Altitude (CRZ ALT)

The cruise altitude from the PERF INIT page is displayed. A new altitude can be manually entered.

3 Target Speed (TGT SPD)

Displays computed values or manually entered values for the selected mode.

Airspeed and/or Mach may be entered using the keyboard. Title will display manually entered value.

The active controlling speed is highlighted in reverse video.

4 Speed Restriction (SPD REST)

The speed restriction line displays the speed restriction/altitude from one of the following sources:

- the navigation database value for the origin airport (dashes displayed when no speed restriction exists for the listed airport)
- waypoint related restriction from the RTE LEGS page if restriction limits climb speed
- a default speed of 250 knots and 10,000 feet for airports not listed in the navigation database (example 250/10000)
- displays XXX/FLAPS if the active speed restriction is lower than the minimum speed for the selected flap setting
- displays XXX/HOLD when decelerating to hold speed prior to hold entry fix.

Dashes displayed if no active speed restriction exists.

737 Flight Crew Operations Manual

Manual crew entries or deletions may be made. HOLD or FLAPS speed may not be deleted or modified.

Note: If the FMC default speed restriction is overwritten, it will be deleted and not return after the overwrite condition passes (e.g. the default of 250/10000 is overwritten to 230/3000, after 3000 feet is passed there will be no speed restriction and VNAV will accelerate to the unrestricted climb speed).

The active controlling speed is highlighted in reverse video.

5 Climb Page Prompts

Push – selects various CLB pages.

Following line selection, the prompt for that page blanks.

6 AT XXXXX

The waypoint constraint line displays the next waypoint having an altitude constraint. Constraints are entered on the RTE LEGS page or by departure procedure selection. The constraints can be deleted on this page or the RTE LEGS page. The waypoint may be a HOLD AT point.

Display is blank if no restriction exists.

7 TO XXXXXX

Displays ETA and distance to go to waypoint on AT XXXXXX line.

If no waypoint constraint exists, values are for CRZ ALT.

8 Error (ERR XXXXX)

Displays predicted altitude undershoot for the waypoint on AT XXXXXX line.

During VNAV operation, the FMC commands a level off if an overshoot is predicted.

Display is blank, including the label, if no error exists.

9 Climb N1 (CLB N1, CLB – X N1)

Displays the computed climb N1 value.

10 Engine Out (ENG OUT)

Push – displays RT ENG OUT and LT ENG OUT prompts. See ENG OUT CLB page description.

11 Required Time of Arrival (RTA)

Push – displays the RTA PROGRESS page.

ERASE prompt replaces RTA during a page modification.

RTA Climb Page

The RTA climb page is displayed when a required time of arrival is active.

The RTA climb page is automatically selected by pushing the CLB function key when RTA is active.

Displays on this page are the same as other climb pages except as noted.

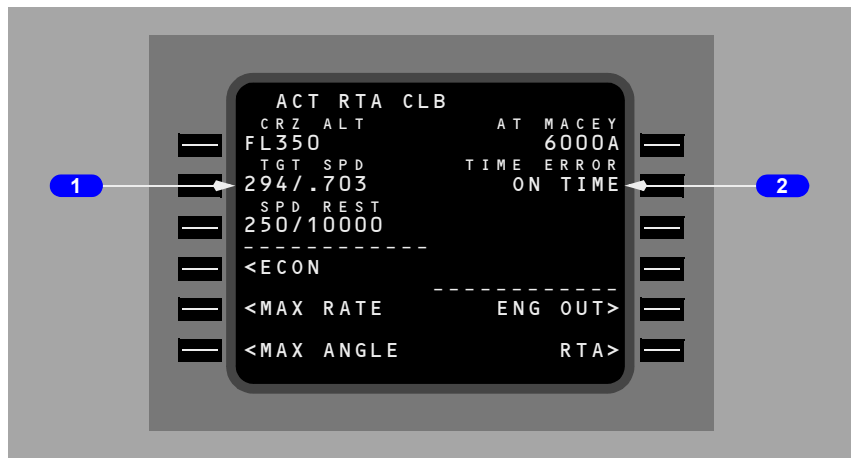

1 Target Speed (TGT SPD)

Displays computed speed required to meet entered RTA.

When RTA is exited by waypoint sequence or deletion, this speed changes to FMC target speed.

2 TIME ERROR

Displays computed time error at RTA waypoint. Same as RTA PROGRESS page.

RTE LEGS Page

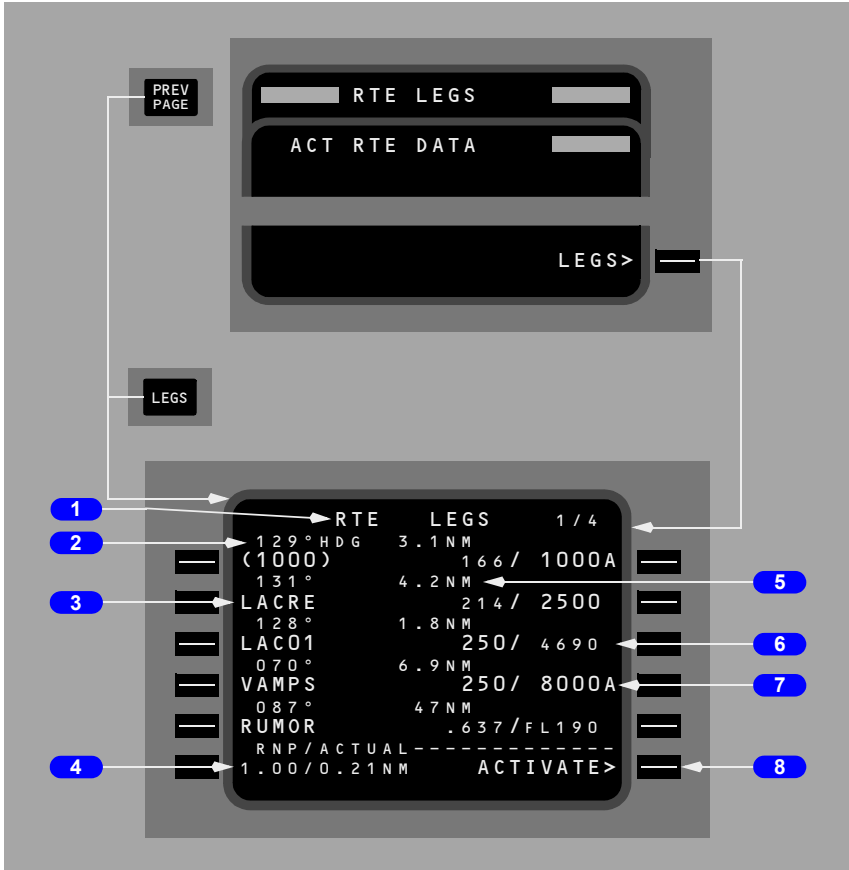

1 Page Title

An active route legs page title is displayed with ACT as part of the title. A modified page title displays a reverse video MOD.

2 Leg Direction

The leg segment direction is displayed as the title of the waypoint line. Courses are displayed in magnetic (xxx°) or true (xxx° T). Directions to maintain an arc display the arc distance, the word ARC followed by the direction, and left or right (24 ARC L). The computed great circle route leg directions may be different than chart values. Heading leg segments to conditional waypoints are displayed as (xxx° HDG) and track leg segments are displayed as (xxx° TRK). Directions may be displayed as special procedural instructions, such as HOLD AT or PROC TURN.

Display is blank for an undefined course.

3 Waypoint Identifier

The current active leg is always displayed at the top of the first active RTE LEGS page.

All route waypoints are displayed. Waypoints on an airway are included on the route legs page. Waypoints appear in flight sequence.

Waypoints can be entered and moved. This includes:

- adding new waypoints
- removing existing waypoints
- resequencing existing waypoints
- linking route discontinuities.

Displays the waypoint by name or condition.

Box prompts are displayed for route discontinuities.

Dashes are displayed for the next line beyond the end of the route.

4 Required Navigational Position/Actual (RNP/ACTUAL)

Displays the required navigation accuracy compared to actual navigation accuracy.

Manual entry is allowed.

5 Distance to Waypoint

Displays the distance from the airplane or the waypoint to the next waypoint.

6 Calculated Waypoint Speed/Altitude

Displays the calculated speed or altitude at the waypoint in small font.

7 Specified Waypoint Speed/Altitude

Displays any waypoint speed or altitude constraint in large font.

Manual entry is allowed.

8 **ACTIVATE, RTE DATA**

The activate prompt is displayed on the legs page when the route is not active.

Push –

- **ACTIVATE** arms the execute function. Pushing the **EXEC** key activates the route and changes the **ACTIVATE** prompt to **RTE DATA**
- **RTE DATA** displays the route data page. The **RTE DATA** prompt is used to review or modify additional information about the route.

Map Center Step Display

The map center step prompt replaces ACTIVATE or RTE DATA when the EFIS control panel mode selector is placed in the PLAN position. Pushing the prompt key advances the waypoint that is displayed in the center of the navigation display. The label <CTR> is displayed to the right of the corresponding waypoint on the RTE LEGS page.

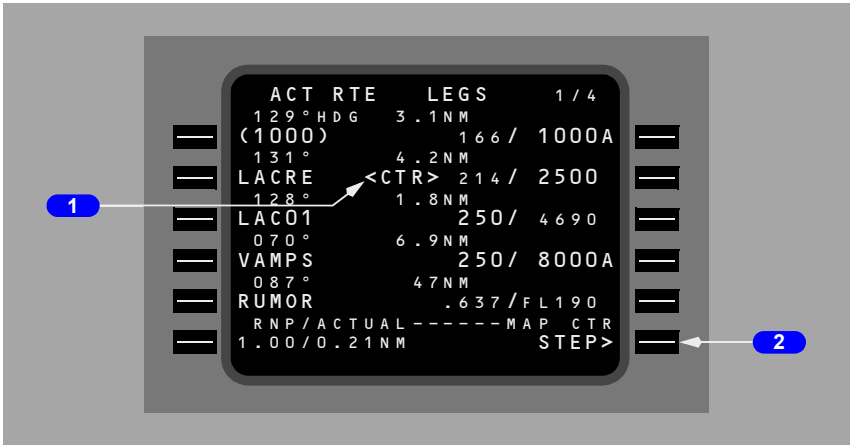

1 Map Center Label (<CTR>)

Identifies the waypoint around which the map display is centered.

Whenever the EFIS Mode selector is positioned to PLAN, the label is automatically displayed for the first geographically fixed waypoint on the displayed page.

2 STEP

Displayed on a CDU when PLAN is selected on the associated EFIS control panel. Replaces the RTE DATA or ACTIVATE prompt.

Push – moves the map center label to the next geographically fixed waypoint in the route.

Progress Page 1/X

The progress page provides general flight progress information along the route of flight such as:

- waypoints (last, active and next)
- destination information
- waypoint ETA
- altitude change points
- waypoint ATA
- current wind
- distance to go information
- fuel quantity

The page title displays the company flight number from the RTE page.

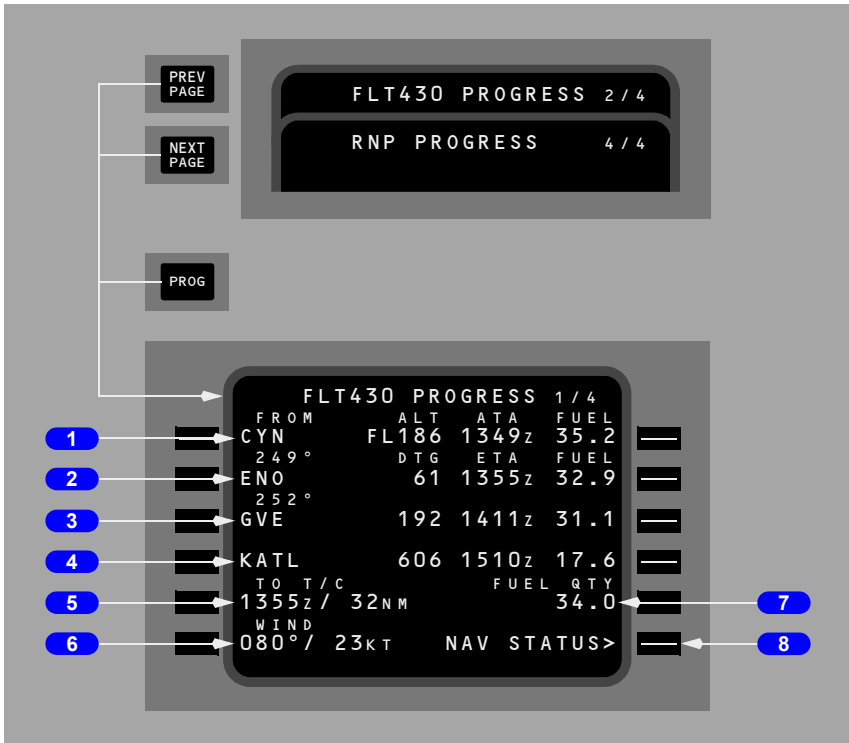

1 FROM

Displays the identifier of the last (FROM) waypoint, the altitude (ALT), the actual time of arrival (ATA), and the fuel at that waypoint.

2 Active Waypoint

Displays the identifier of the active waypoint, the flight plan course to the active waypoint, and distance-to-go (DTG) from present position to the active waypoint. Also displays the estimated time of arrival (ETA) and predicted fuel remaining at the active waypoint. The active waypoint is highlighted by reverse video.

3 Next Waypoint

Displays the identifier of the next waypoint which follows the active waypoint, the flight plan course for that leg, and flight plan distance-to-go (DTG) from present position to the next waypoint. Also displays the estimated time of arrival (ETA) and predicted fuel remaining at the next waypoint.

4 Destination

Displays the identifier of the destination airport (DEST) and flight plan distance-to-go (DTG) from present position to the destination. Also displays estimated time of arrival (ETA) and predicted fuel remaining at the destination.

When a route modification is in progress, the destination line label displays MOD. Performance predictions include the modification.

5 Altitude Change Point (TO XXXXX)

Displays ETA and distance to go to the following altitude change points as appropriate to phase of flight:

- TO T/C: to top of climb for the active climb
- TO T/D: to top of descent, if no STEP TO entry is made on CRZ page
- TO STEP POINT: to the step point if a STEP TO entry is made on CRZ page
- TO E/D: to the end of descent waypoint for an active path descent; blank if a path descent is not available.

6 WIND

Displays current true wind direction and speed.

7 Fuel Quantity (FUEL QTY)

Displays the present total fuel quantity remaining as obtained from the airplane fuel quantity indication system.

8 NAV STATUS

Push – displays the navigation status page.

Progress Page 2/4

The progress page 2/4 displays wind, track, path, temperature, and speed data.



1 HEADWIND or TAILWIND

Displays the present headwind or tailwind component.

2 WIND

Displays the present true wind direction/speed.

3 Crosstrack Error (XTK ERROR)

Displays present cross-track error from the desired LNAV course.
Blank if error is greater than 99.9 nm.

4 CROSSWIND

Displays present crosswind component (left or right).

5 Static Air Temperature/ISA Deviation (SAT/ISA DEV)

Displays present SAT and the equivalent ISA deviation.

6 Vertical Descent Path Deviation (VERT DEV)

Displays present computed deviation (HI or LO) from the FMC vertical path.
Blank if descent not active or path not available.

7 TAS

Displays present TAS.

8 PRE-FLIGHT REPORT

Push – transmits downlink report of preflight data.

9 WEATHER REQUEST

Push – transmits a data link request for a weather uplink.

10 PROGRESS REPORT

Push – transmits a downlink report of progress data.

11 POSITION REPORT

Push – transmits a downlink report of position data.

12 GPS-L TRK

Displays GPS track.

RTA Progress Page 3/4

RTA Progress page is used to initiate the required time of arrival (RTA) mode.

The RTA page provides advisory data on flight progress in the RTA mode and advises of control times such as recommended takeoff time to meet RTA.

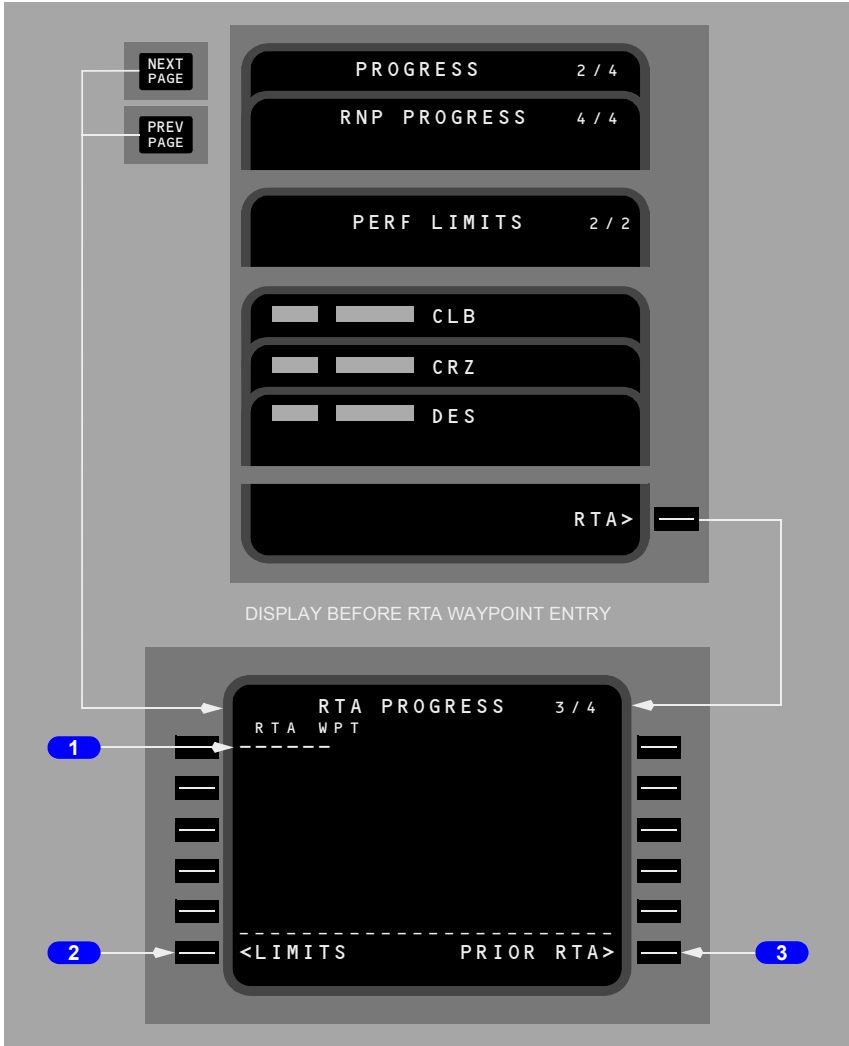

1 Required Time of Arrival Waypoint (RTA WPT)

Displays dashes when entry allowed.

2 LIMITS

Push – displays the PERF LIMITS page.

3 Prior RTA Waypoint (PRIOR RTA)

Prompt displayed when the RTA waypoint field contains dashes and a previous RTA waypoint is still in the flight plan; otherwise blank.

Push – displays last active RTA waypoint data.

RTA Progress on Ground and in Flight

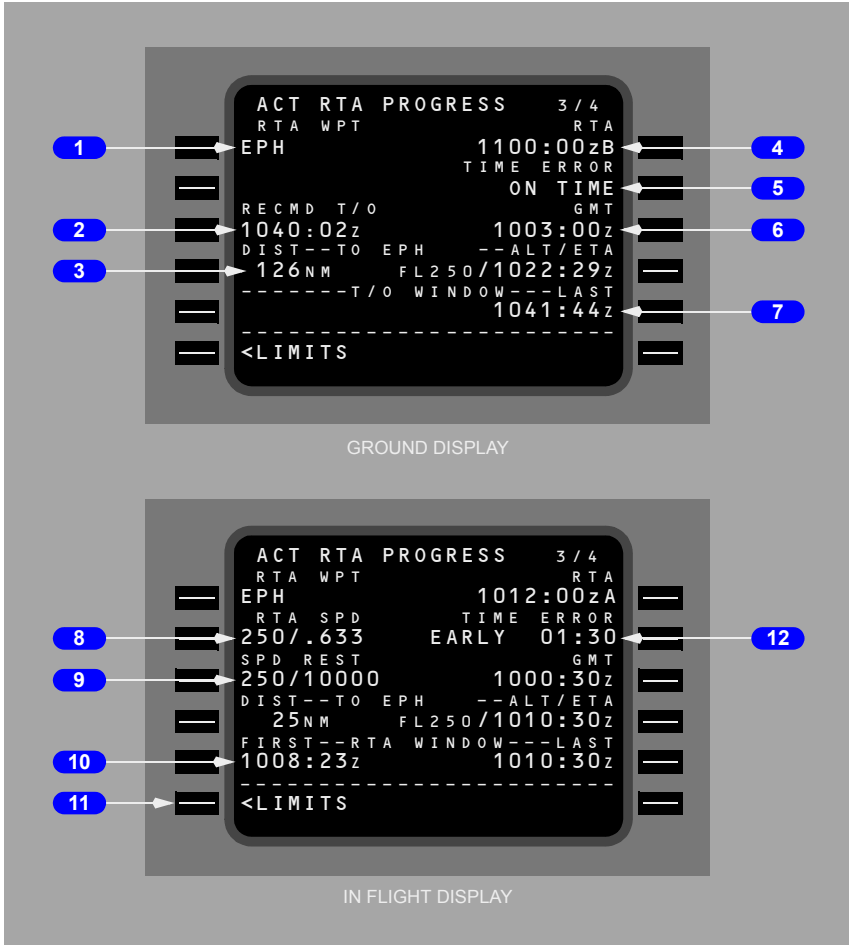

1 Required Time of Arrival Waypoint (RTA WPT)

Waypoint entry must be in flight plan or the CDU message NOT IN FLIGHT PLAN will be displayed.

Entering a valid waypoint will generate a MOD RTA PROGRESS page and illuminate the EXEC light.

Deletion of the RTA waypoint will create a MOD RTA PROGRESS page with all data blanked and EXEC light illuminated. Execution will exit the RTA mode.

Deletion of the RTA waypoint does not remove the waypoint from the flight plan.

737 Flight Crew Operations Manual

Automatically clears the RTA waypoint and exits the RTA waypoint after sequencing the RTA waypoint out of the flight plan.

2 Recommended Takeoff Time (RECMD T/O)

Displays the recommended takeoff time (brake release time) to meet the planned RTA.

Time is based on entered Cost Index as well as the earliest and latest times to achieve RTA..

3 Distance To, Altitude, and ETA at the RTA Waypoint (DIST -- TO XXX -- ALT/ETA)

Displays the distance to the RTA waypoint.

Displays the predicted altitude at the RTA waypoint.

Displays ETA to the RTA waypoint based on:

- immediate takeoff
- MIN/MAX speeds on PERF LIMITS page
- entered forecast winds.

4 Required Time of Arrival (RTA)

After RTA waypoint entry, initially displays current ETA based on the active flight plan and performance parameters at time of waypoint entry.

Desired RTA may be entered by overwriting displayed data.

Entry must be in one of the following forms:

- XXXXXX (hr/min/sec)
- XXXX (hr/min)
- XXXX.X (hr/min/tenths of min).

Entry of “A” after RTA specifies arrival time of at or after.

Entry of “B” after RTA specifies arrival time of at or before.

5 TIME ERROR

Displays the most recent time error in minutes and seconds up to a maximum of 59:59 minutes.

Displays ON TIME if GMT is within current T/O WINDOW.

Displays EARLY or LATE as appropriate if GMT is not within current T/O WINDOW.

6 GMT

Displays the actual GMT.

**7 Takeoff Window (----- T/O WINDOW --- LAST) or
(FIRST -- T/O WINDOW -----)**

Displays latest takeoff time to meet the planned RTA.

If the entered RTA time is “At or After” time, only the FIRST field shall be displayed.

If the entered RTA time is “At or Before” time, only the LAST field shall be displayed.

Time is based on minimum and maximum speeds on the PERF LIMITS page.

8 Required Time of Arrival Speed (RTA SPD)

Displays the target speed required to meet the planned RTA.

Same as speed displayed on RTA CLB, CRZ, or DES page.

Limited by MIN/MAX speeds on the PERF LIMITS page and the SPD REST line.

During cruise, displays XXX/HOLD when decelerating to hold speed prior to hold entry fix.

9 Speed Restriction (SPD REST)

Displays the current speed restriction affecting RTA progress.

When not in cruise, displays XXX/HOLD when decelerating to hold speed prior to hold entry fix.

10 Arrival Time Window (FIRST -- RTA WINDOW --- LAST)

Displays earliest and latest achievable arrival times at the RTA waypoint.

Times based on MIN/MAX speeds on PERF LIMITS page, existing winds, and entered forecast winds.

11 LIMITS

Push – displays PERF LIMITS page.

12 TIME ERROR

In flight, displays difference between the ETA and the RTA plus the TIME ERROR TOLERANCE on the PERF LIMITS page.

RNP Progress Page 4/4

Progress page 4/4 displays essential Required Navigation Performance (RNP) information. The items displayed include waypoint identifier, RNP and ANP values, course, distance, glidepath, cross track error, speeds, altitudes and vertical deviation.

YA373 - YA377, YC202 - YC207, YE324 - YE326

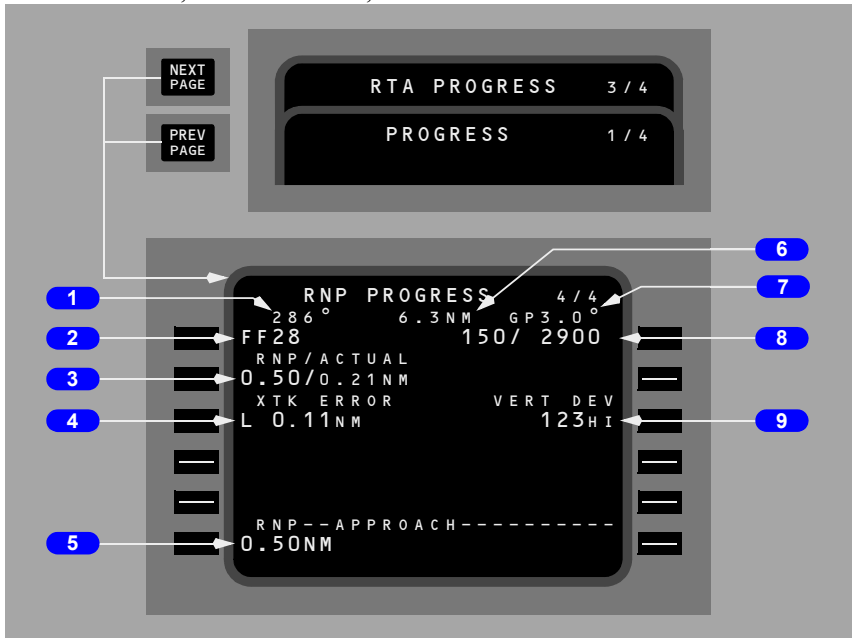

YA371, YA372, YC201, YE321 - YE323

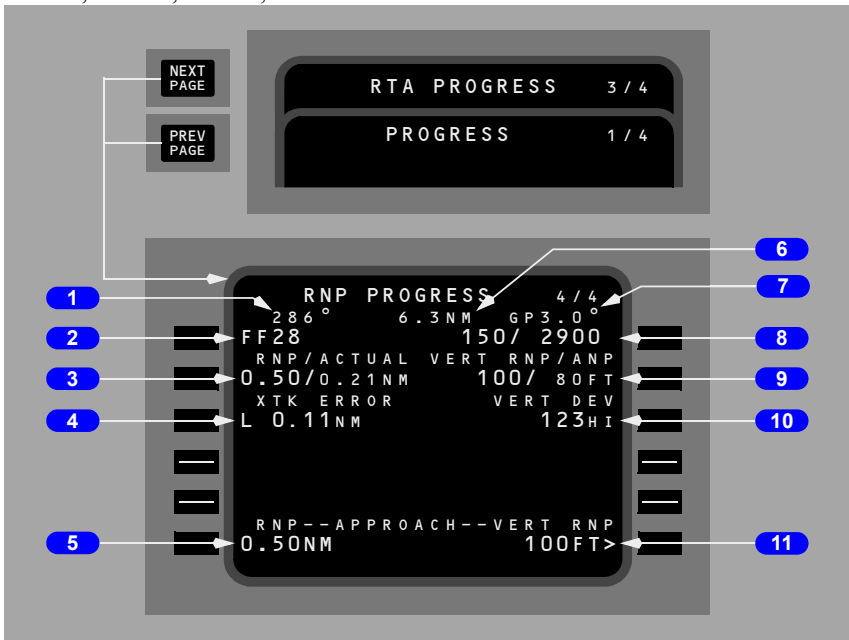

1 Leg Direction

The leg segment direction is displayed as the title of the waypoint line. Courses are displayed in magnetic (xxx°) or true (xxx° T). Directions to maintain an arc display the arc distance, the word ARC followed by the direction, and left or right (24 ARC L). The computed great circle route leg directions may be different than chart values. Heading leg segments to conditional waypoints are displayed as (xxx° HDG) and track leg segments are displayed as (xxx° TRK). Directions may be displayed as special procedural instructions, such as HOLD AT or PROC TURN.

Display is blank for an undefined course.

2 Waypoint Identifier

Displays the next waypoint.

Same as displayed on the RTE LEGS page.

3 Actual RNP

Displays the actual RNP value for lateral navigation.

Same as displayed the POS SHIFT page.

4 Crosstrack Error (XTK ERROR)

Displays present cross-track error from the desired LNAV course.

L or R indicates left or right of course.

Blank if error is greater than 99.9 nm.

5 Lateral RNP (Approach)

Displays the lowest applicable RNP for the approach.

Displays in large font for manually entered RNP.

Displays in small font for values provided by the navigation database.

6 Distance To Go

Displays the distance remaining to the next waypoint.

7 Glidepath

Displays the FMC computed glidepath for the approach.

8 Waypoint Speed/Altitude

Displays waypoint speed or altitude constraints in large font.

Displays FMC predicted values in small font when no restrictions have been specified.

9 Vertical Deviation

YA373 - YA377, YC202 - YC207, YE324 - YE326

Displays present vertical deviation from the FMC computed glidepath.

9 Vertical Navigation Performance

YA371, YA372, YC201, YE321 - YE323

Displays both the vertical RNP (Required Navigation Performance) and the vertical ANP (Actual Navigation Performance) for the current leg.

Valid display range for vertical ANP is 0 to 999 feet.

Manual entries are allowed and are displayed in large font.

Valid entries are 10 to 999 feet and may be suffixed with an optional “/”

Entries are cleared at flight completion.

Values from the navigation database are displayed in small font.

10 Vertical Deviation

YA371, YA372, YC201, YE321 - YE323

Displays present vertical deviation from the FMC computed glidepath.

11 Vertical RNP (Approach)

YA371, YA372, YC201, YE321 - YE323

Displays the lowest applicable vertical RNP for the approach.

Manual entries (entered in 2R) are displayed in large font.

Values from the navigation database are displayed in small font.

N1 Limit Page

This section describes the in-flight version of the N1 LIMIT page. See the FMC Preflight section for a description of the preflight version of the N1 LIMIT page.

Normally, N1 limits are automatically specified. Pilot selection of other limits is allowed.

Pilot selection of a reduced climb mode does not change the automatic selection for other phases of flight.

Pilot selected mode is automatically replaced by AUTO selection when the autopilot next changes vertical mode.

The active thrust limit is used by the autopilot and is displayed on the thrust mode display.

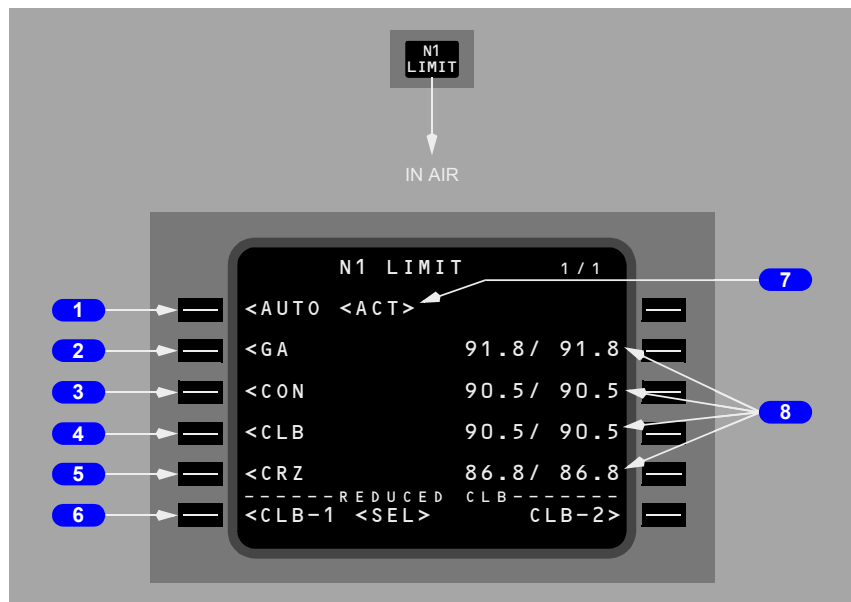

1 AUTO

Push – selects automatic computation of N1 limits for all phases of flight.

2 Go Around (GA)

Push – selects the go-around thrust limit.

3 Continuous (CON)

Push – selects the maximum continuous thrust limit.

4 Climb (CLB)

Push – changes the thrust mode from AUTO to the active climb thrust, i.e. CLB, CLB-1, or CLB-2.

5 Cruise (CRZ)

Push – selects the cruise thrust limit.

6 Reduced Climb (REDUCED-CLB)

Push – selects either of two reduced climb thrust modes.

CLB-1 provides a climb limit reduced by 3% N1 (approximately 10% thrust).

CLB-2 provides a climb limit reduced by 6% N1 (approximately 20% thrust).

The reduced climb N1 value is displayed on the CLB pages.

If either mode is <SEL>, deletion allows return to full rated climb thrust.

Any reduced climb selection is automatically deleted above 15,000 feet.

Note: If a reduced thrust takeoff has been specified on the TAKEOFF REF page, the FMC will re-compute CLB-1 and CLB-2 values as required to avoid a climb N1 value greater than the reduced thrust takeoff N1 value.

7 <ACT> STATUS LABEL

Identifies the active N1 thrust limit.

8 N1

Displays the N1 for individual thrust limits based on present conditions and bleed air configuration.

If CLB-1 or CLB-2 is selected, the N1% for CLB and the N1 cursors still display values for full rated climb.

Engine Out Climb

Engine out climb advisory data is available on the CLB page. Engine out data is also available with both engines operating. The engine out climb phase automatically transitions to the engine out cruise phase when reaching the cruise altitude.

Engine Out Climb Page

Displays advisory information for an engine inoperative condition. Once the page is selected, it cannot be executed.

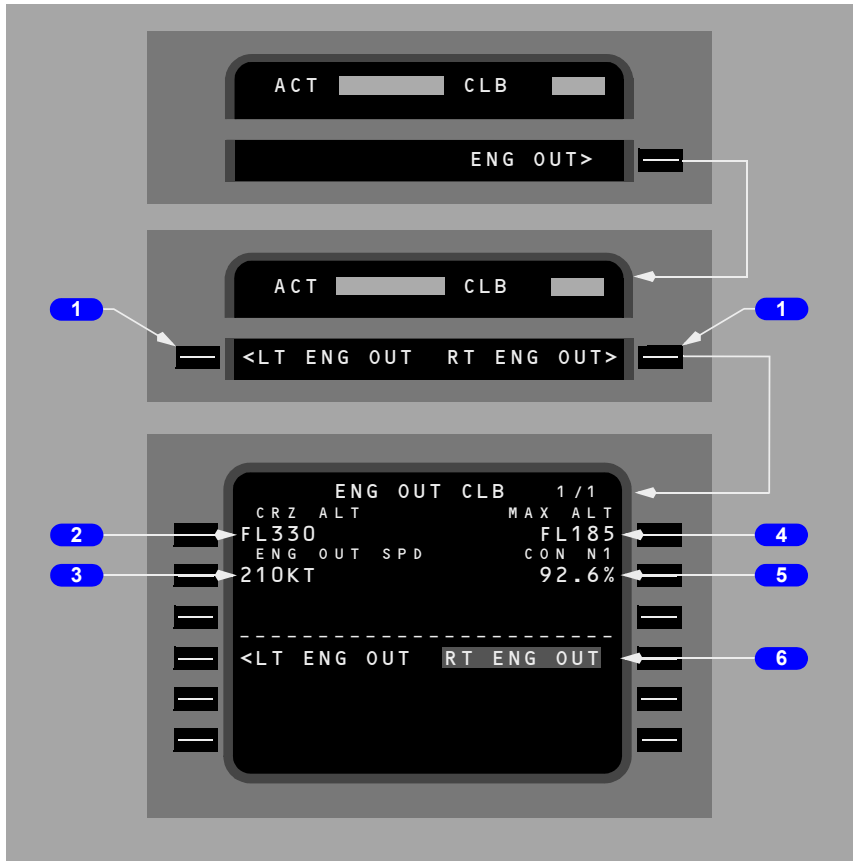

1 Left/Right Engine Out (LT ENG OUT/RT ENG OUT)

Displayed after selection of ENG OUT prompt.

2 Cruise Altitude (CRZ ALT)

Displays the current active cruise altitude. Value is forwarded from either the PERF INIT, CRZ, CRZ CLB, or CRZ DES pages. Manual entry not allowed.

3 Engine Out Speed (ENG OUT SPD)

Displays the minimum drag engine out climb speed.

4 Maximum Altitude (MAX ALT)

Displays the maximum altitude at which company specified rate of climb can be achieved using one engine at maximum continuous thrust.

After page selection, the FMC accounts for wing and engine anti-ice, air conditioning and engine bleed of the operating engine.

5 Continuous N1 (CON N1)

Displays the N1 for maximum continuous thrust.

6 LT ENG OUT/RT ENG OUT

Selected engine is shown in reverse highlighting.

Air Turnback

Arrivals Page

During a turn-back situation, the crew requires quick access to the arrivals information for the origin airport. The departure/arrivals index and arrivals page provide access without changing the destination on the route page. See Chapter 11, Section 43 for additional information on the arrivals page.

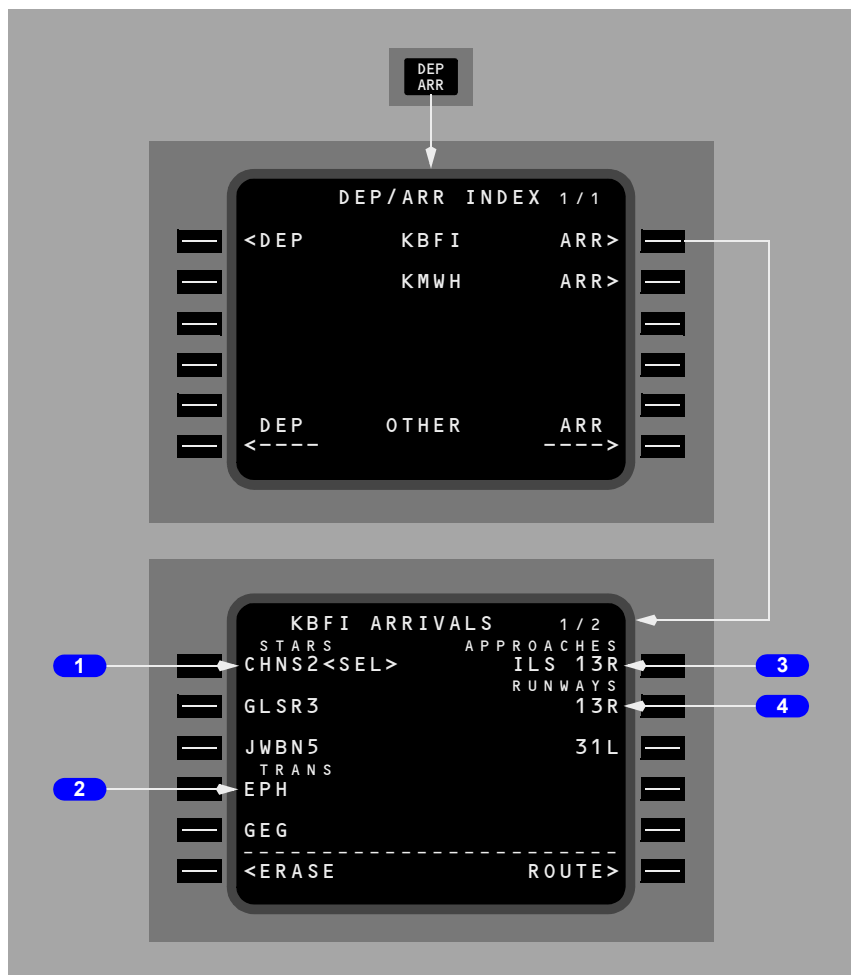

1 Standard Terminal Arrival Routes (STARS)

Displays STARS for the origin airport.

2 **Transitions (TRANS)**

Displays transitions for the origin airport.

3 **APPROACHES**

Displays approaches for the origin airport.

4 **RUNWAYS**

Displays runways for the origin airport.



Introduction

The cruise phase automatically begins when the top of climb is reached.

During cruise, the primary FMC pages are:

- RTE LEGS
- PROGRESS
- CRZ.

The RTE LEGS pages are used to manage route restrictions and modify the route. The PROGRESS pages display flight progress information. RTA requirements are also specified on the PROGRESS pages. The CRZ pages display VNAV related information. Other pages include:

- POS REF page – verifies the FMC position (refer to Section 40 of this chapter)
- POS SHIFT page – permits selection of preferred position from list of references
- RTE DATA page – displays progress data for each waypoint on the RTE LEGS page. Displays wind data for cruise waypoints.
- REF NAV DATA page – displays information about waypoints, nav aids, airports, or runways
- LATERAL OFFSET page – permits selection of a route offset
- FIX INFO page – displays information about waypoints, and can be used to create new waypoints and fixes
- SELECT DESIRED WAYPOINT page – permits selection of the desired waypoint from a list of duplicate named waypoints
- NAV STATUS page – displays information about available navigation aids.

The only cruise mode automatic page changes are the transition from climb to cruise at the top of climb point and from cruise to descent at the top of descent point.

LNAV Modifications

This section presents the normal techniques for modifying the route. The modifications include:

- adding and deleting waypoints
- linking discontinuities
- resequencing waypoints
- intercepting a course.

RTE LEGS Page Modifications

When modifications are made to the RTE LEGS page, several automatic prompt or identifying features assist in managing and executing the modifications, such as:

- ERASE
- INTC CRS.

Adding Waypoints

A waypoint can be added to the route whenever necessary.

The new waypoint must first be placed into the CDU scratchpad. Existing waypoints can be copied from a RTE LEGS page into the scratchpad by pushing the line select key adjacent to the desired waypoint.

The new waypoint is then inserted into the route at the desired sequence point by pushing the line select key adjacent to the desired location for the new waypoint. Using the NEXT PAGE/PREV PAGE function keys to select the desired location does not alter the CDU scratchpad. The new entry automatically links to the preceding waypoint via a direct route. Placing the new waypoint into the active waypoint line is a special case and is discussed under Intercept Course in this section.

All new waypoints, except along track waypoints, cause a route discontinuity between the new waypoint and the following waypoint.

Note: If the FMC NAV database contains a HOLD pattern at the FAF, executing a database approach with a procedure turn and then executing a HOLD at the same FAF, using any inbound course, may cause a discontinuity between the FAF and the procedure turn. If the discontinuity is removed, LNAV guidance is available to fly the approach from the published holding pattern. LNAV guidance is not available to fly the published procedure turn.

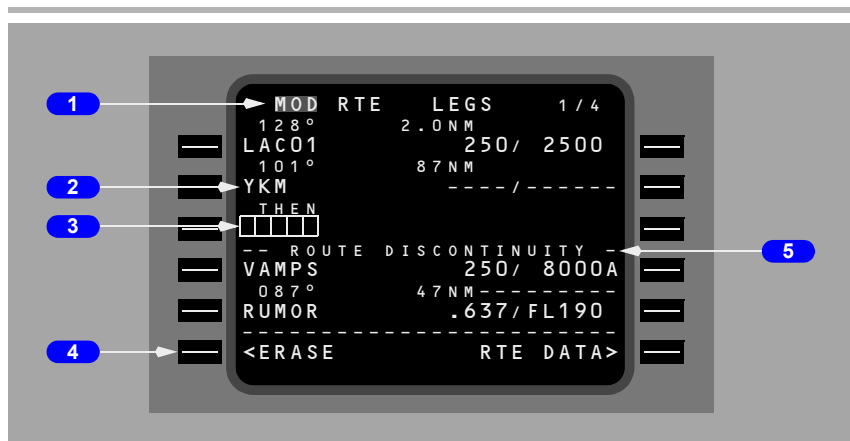

1 Page Title

When the page is modified, MOD appears in front of the title in reverse highlighting. This means the route is now altered. The MOD title also shows that the modifications are not yet executed and can be removed using the ERASE prompt.

2 Modified Waypoint

YKM waypoint is entered into the route between LAC01 and VAMPS. This modification creates a route discontinuity.

3 Discontinuity Waypoint

Box prompts indicate the requirement to link the route by entering a route waypoint into the discontinuity waypoint position.

4 ERASE

The ERASE prompt is displayed when the first modification is entered. The prompt remains on the page until the modifications are erased or executed.

Push – removes all modifications and restores all active data.

5 Discontinuity Header

Indicates that the route is not continuous. Distance to destination on the PROGRESS page is not correct.

Deleting Waypoints

Waypoints can be removed from the RTE LEGS page. There are two normal methods to remove a waypoint:

- delete the waypoint using the DEL function key (not possible for the active waypoint and some conditional waypoints)
- resequence the route by moving a down-route waypoint up in the sequence and automatically removing all waypoints that are between.

During the deletion process, all of the route prior to the deletion point remains unchanged. Removing a waypoint using the DEL function key causes a route discontinuity to replace the deleted waypoint.



1 Active Route

The existing route shows VAMPS followed by BANDR, BEEZR, and ELN.

2 DELETE Entry

Push the DEL key to arm the delete function. DELETE is displayed in the scratchpad.

3 Delete VAMPS

With DELETE displayed in the scratchpad, push the line select key left of VAMPS to delete the waypoint. Box prompts replace VAMPS and a route discontinuity follows the box prompts.

Resequencing Waypoints



1 Active Route

The existing route shows VAMPS followed by BANDR, BEEZR, and ELN. The airplane must fly direct from LAC01 to BANDR. The BANDR waypoint is copied into the scratchpad.

2 Resequence BANDR

BANDR is transferred to the waypoint following LAC01. VAMPS is removed, and the route remains continuous.

Leg Bypass



1 Bypass Notification

A waypoint (BAN01) has been entered into the route which is very close to another route waypoint (BANDR). It is impossible for the airplane to turn and capture the leg between BANDR and BAN01, so a bypass is noted.

Turn construction is based upon FMC criteria which assume that LNAV is engaged. Normal turn construction may not be possible under certain combinations of airspeed, short leg length, and a significant change in leg direction. If normal turn construction cannot provide a continuous path, the FMC bypasses the affected leg and uses alternative turn construction to intercept the leg to the subsequent waypoint. When the bypass is for the active waypoint, the waypoint remains active until the airplane passes abeam.

Any mandatory altitude-crossing restriction for the bypass waypoint is still observed if VNAV is engaged, based on passing abeam the waypoint.

If a triple bypass condition occurs (bypass of three consecutive legs), a route discontinuity will be inserted.

Removing Discontinuities

A discontinuity exists when the FMC is unable to determine the route leg following a waypoint. Discontinuities are removed by linking the route segment following the discontinuity to the route segment preceding the discontinuity.

The next desired waypoint from the subsequent route is copied into the CDU scratchpad and entered into the discontinuity, just as when adding a waypoint.



1 ROUTE DISCONTINUITY

The active route shows a discontinuity. The airplane must fly direct from LAC01 to BANDR. The BANDR waypoint is copied into the scratchpad in preparation to remove the discontinuity. Any waypoint from the route can be copied into the scratchpad to remove the discontinuity.

2 Continuous Route

BANDR is copied into the box prompts to remove the discontinuity.

Entering a waypoint which does not already exist on the route moves the discontinuity one waypoint farther down the route.

Direct To and Intercept Course

To fly direct to a waypoint or intercept a course to a waypoint, enter the waypoint name on RTE LEGS page 1 active waypoint line. The INTC CRS prompt displays in line 6R. The example shows the result with YKM entered into the active waypoint line.

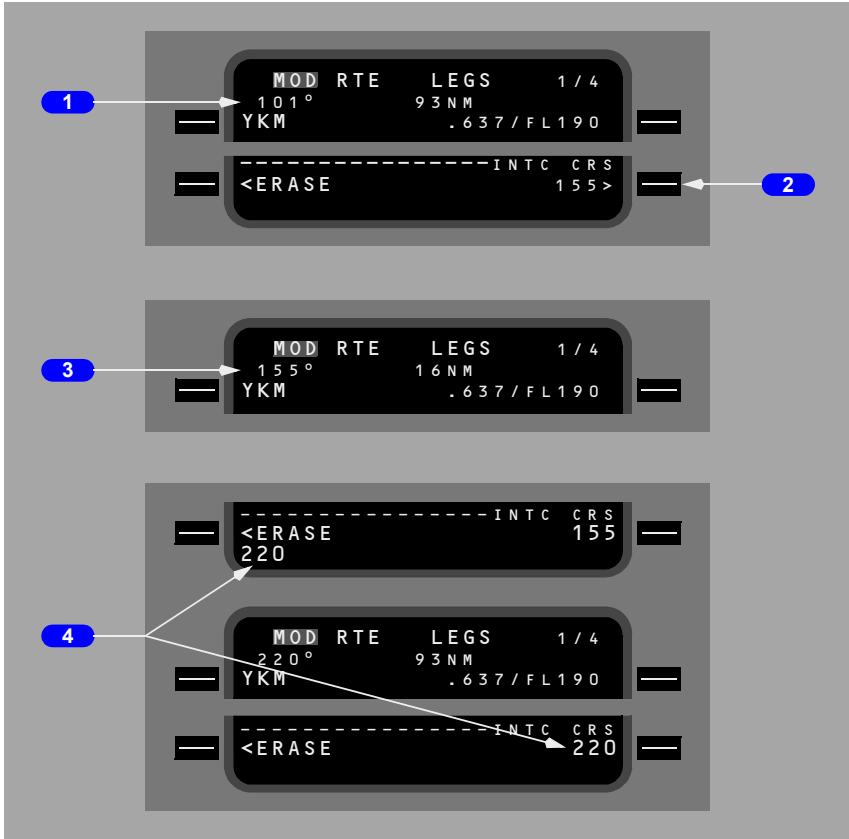

1 Direct Course

Direct course from airplane present position to entered waypoint.

Execute to proceed direct to active waypoint.

2 Intercept Course (INTC CRS)

Push – puts displayed course (155) into active waypoint leg direction. Enables intercept course function.

Displayed whenever the active waypoint name is modified.

737 Flight Crew Operations Manual

Displays flight plan leg direction to entered waypoint in small font. Displays dashes if entered waypoint was not in the flight plan.

Valid input is any course from 000 through 360. May be changed until executed. Entered or selected value displays in large font.

3 Leg Direction

Displays the course inbound to the active waypoint after selecting the course displayed in the INTC CRS line.

4 Intercept Course (INTC CRS) – Change

Enter the inbound intercept course to the modified waypoint in the scratchpad. Select the INTC CRS line to change the leg direction.

The example shows 220° intercept course to YKM entered in the INTC CRS line.

Select Desired Waypoint Page

When a waypoint identifier is not unique (other database waypoints have the same name), a selection of which latitude/longitude to use must be made before that waypoint can be used in the route.

YA371 - YC206, YE321 - YE326

The SELECT DESIRED WPT page is automatically displayed when the FMC encounters more than one identifier for the same waypoint name after a waypoint entry.

YA371 - YC206, YE321 - YE326

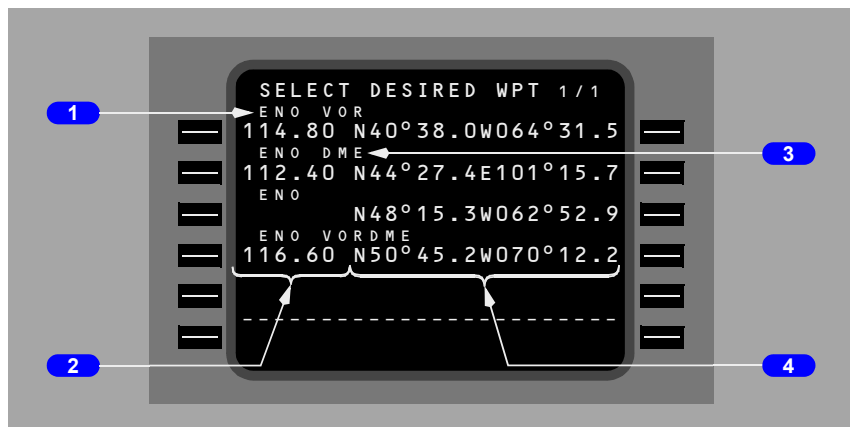

1 Identifier

Displays the identifiers for the duplicate named waypoints. Select the proper waypoint by pushing the appropriate left or right line select key. This page is automatically removed after a waypoint is selected.

2 Frequency

Displays the frequency of the navaid.
Blank if the waypoint is not a navaid.

3 Type

Shows type of navaid.
Available types include VOR, VORTAC, VORDME, NDB, LOC, ILS, DME, ILS/DME, LOCDME, APT or WPT.

4 Latitude/Longitude

The latitude/longitude is displayed for each duplicate name.

YC207

The SELECT DESIRED XXX page is automatically displayed when the FMC encounters more than one identifier for the same waypoint name after a waypoint entry.

YC207



1 Identifier

Displays the identifier for the duplicate named waypoints. Select the proper waypoint by pushing the appropriate left or right line select key. This page is automatically removed after a waypoint is selected.

2 Type

Shows type of navaid.

Available types include VOR, VORTAC, VORDME, NDB, LOC, ILS, DME, ILSDME, LOCDME, APT or WPT.

3 Frequency

Displays the frequency of the navaid.

Blank if the waypoint is not a navaid.

4 Waypoint Name

Displays the name of the waypoint.

Blank if the waypoint is not a navaid.

5 Latitude/Longitude

The latitude/longitude is displayed for each duplicate name.

Lateral Offset

A lateral offset may be specified up to 99.9 nautical miles left or right of course. The OFFSET prompt is displayed on the INIT/REF INDEX page and in flight on the RTE page. Selection displays the LATERAL OFFSET (or ACT LATERAL OFFSET page if an offset already exists).

Some legs are invalid for offset. These include:

- End of flight plan waypoint
- Discontinuity
- Beginning of approach transition
- Approach procedure
- DME arc
- Heading leg
- Holding pattern (except PPOS)
- Certain legs containing flyover waypoints
- Course change greater than 135 degrees
- Preplanned termination waypoint.

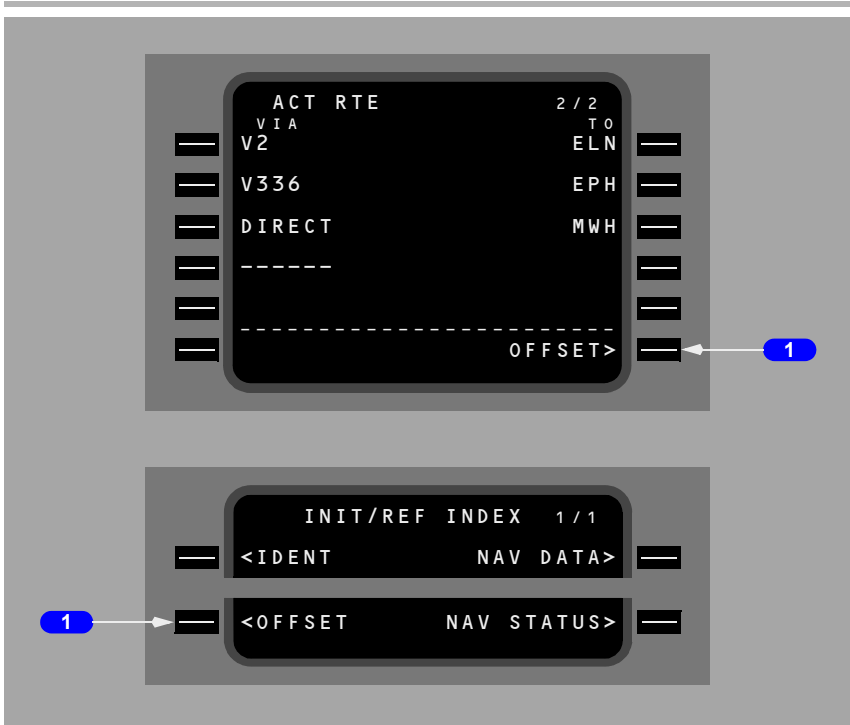

1 OFFSET

Push – displays the lateral offset page.

Lateral Offset Page

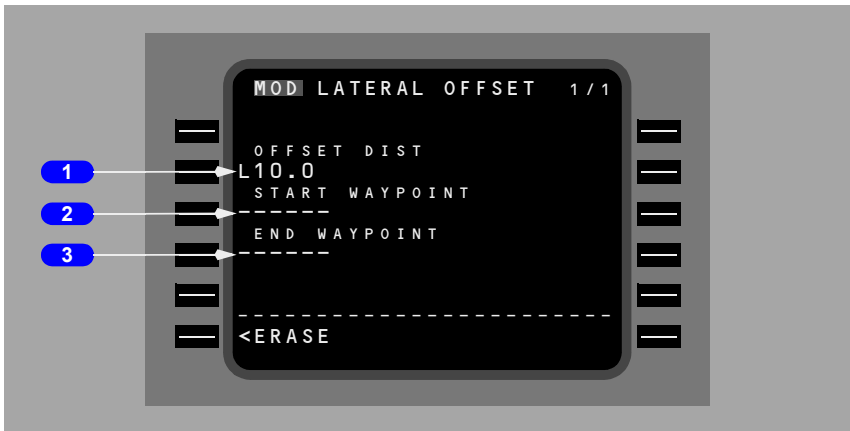

737 Flight Crew Operations Manual

1 Offset Distance (OFFSET DIST)

The desired lateral offset distance is entered on line 2L. In the example, the 10.0 nm offset left of course could be entered L10.0, L10, 10.0L, or 10L.

Entry results in display of start and end waypoint fields.

2 START WAYPOINT

The waypoint at which the offset is to begin may be entered (up to 6 characters).

Dashes are displayed if current leg is valid for offset. Box prompts are displayed if current leg is invalid for offset.

Offset will begin at first valid offset leg after the start waypoint.

Deletion of start waypoint (or no entry) will result in offset beginning at first valid offset leg in the flight plan.

3 END WAYPOINT

The waypoint at which the offset is to end may be entered (up to 6 characters).

Offset will propagate through flight plan until end waypoint is encountered.

Deletion of end waypoint (or no entry) will result in offset propagating until an invalid offset leg is encountered.

Progress Page

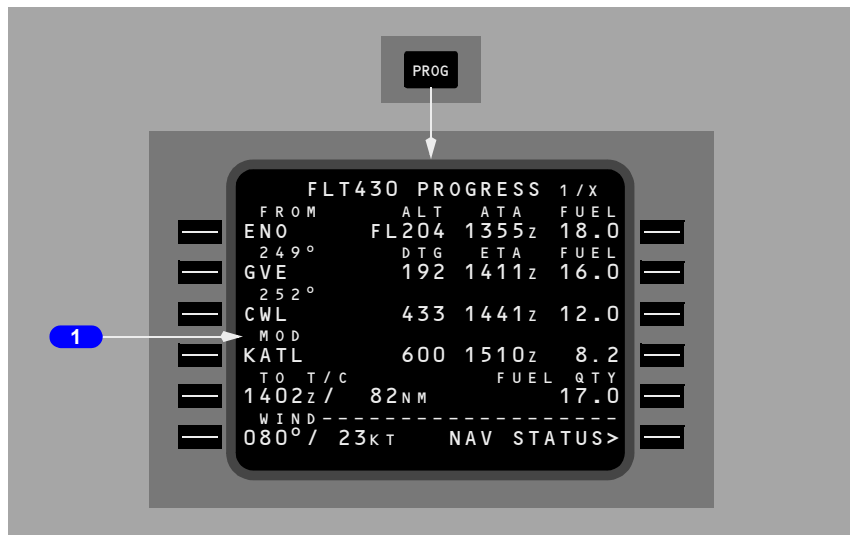

1 Modified (MOD)

Displays MOD when the route is being modified.

Line data is valid for the modified route.

VNAV Modifications

Three primary cruise modes are available – economy (ECON) cruise, long range cruise (LRC), and cruise with a manually selected speed.

Access to the various cruise pages is obtained by pushing the CRZ mode select key.

Cruise Page

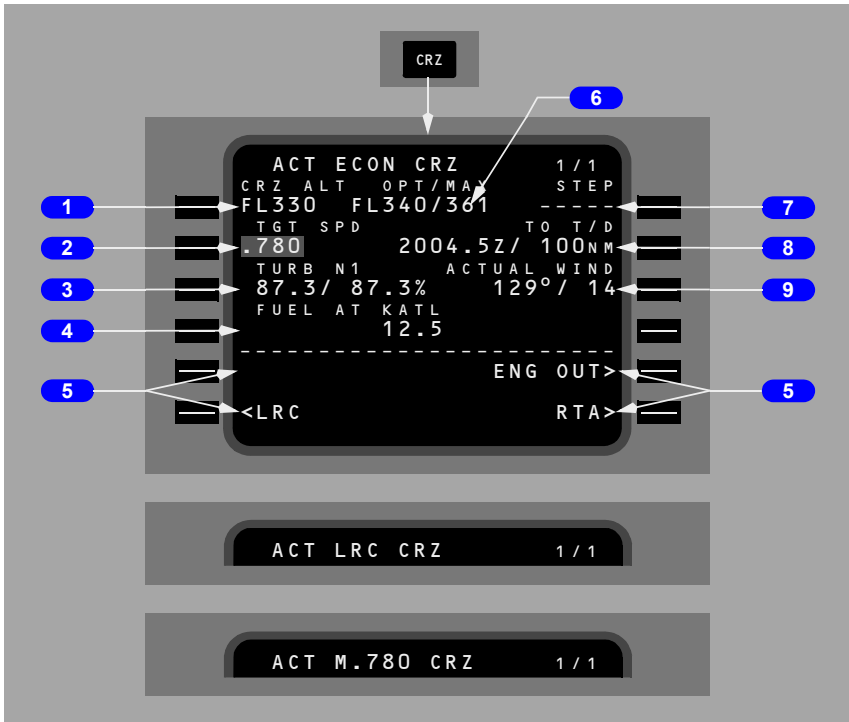

1 Cruise Altitude (CRZ ALT)

Displays present cruise altitude in flight level or feet x 100. Value may be entered via the keyboard or propagated from the PERF INIT, CLB, CRZ CLB, or CRZ DES pages.

During active cruise, entry of a new value propagates to all other pages which display cruise altitude and causes the MOD CRZ CLB or MOD CRZ DES page to appear.

2 Target Speed (TGT SPD)

The computed target speed displays one of the following:

- computed or manually selected value for target airspeed or Mach
- XXX/HOLD when decelerating to hold speed prior to the hold entry fix
 - deletion or modification of hold speed is not allowed.

The value is reverse highlighted on an active cruise page.

3 Turbulence N1 (TURB N1)

Displays proper N1 for turbulence penetration.

Value is for reference only. It is not commanded to the autothrottle.

4 Fuel at Destination (FUEL AT XXXX)

Displays the predicted fuel remaining at destination.

The value assumes continued flight per the displayed cruise and planned descent modes along the active route.

If a step to altitude is entered on line 1R, the computation assumes that the step will occur at the step point. After passing the step climb point, the predicted fuel weight is based on an immediate step climb from current position.

5 Cruise Page Prompts

Allow line selection of the various cruise pages.

The RTA prompt is replaced with ERASE when a MOD page is displayed.

6 Optimum/Maximum Altitude (OPT/MAX)

Displays the computed optimum altitude for the displayed cruise mode. The value is not constrained by minimum cruise time criteria (as is the TRIP ALT on the PERF INIT page).

Also displays the maximum possible altitude based on the selected target speed and the specified maneuver margin.

Values are advisory only. They are provided for crew reference.

7 Step to Altitude Line (STEP)

This line may be used to enter a possible step climb or descent altitude for crew evaluation.

The line will be blank when within 100 nm of top of descent or when RTA mode is active.

8 Top of Descent (TO T/D) Line

Displays time of arrival at and distance to top of descent point.

The data is always displayed when the distance is less than 100 nm. If the distance is more than 100 nm, the data will be displayed only if a step to altitude has not been entered.

9 ACTUAL WIND

Displays computed or manually entered true wind for present altitude.

A manual entry has priority. The data line title then changes to EST WIND (estimated wind).

The displayed value is used as the assumed true wind at the step to altitude for making wind/altitude trade computations.

RTA Cruise

If an RTA waypoint has been specified, the cruise page will reflect the RTA data.



1 Target Speed (TGT SPD)

Displays the computed speed required to meet the RTA.

When RTA mode is exited by waypoint sequence or by deletion, this speed becomes the FMC target speed on a manual speed cruise page and the scratchpad message SELECT MODE AFTER RTA is displayed.

2 TIME ERROR

Displays the computed time error at the RTA waypoint.

Same as time error on RTA PROGRESS page.

Cruise with Step Climb

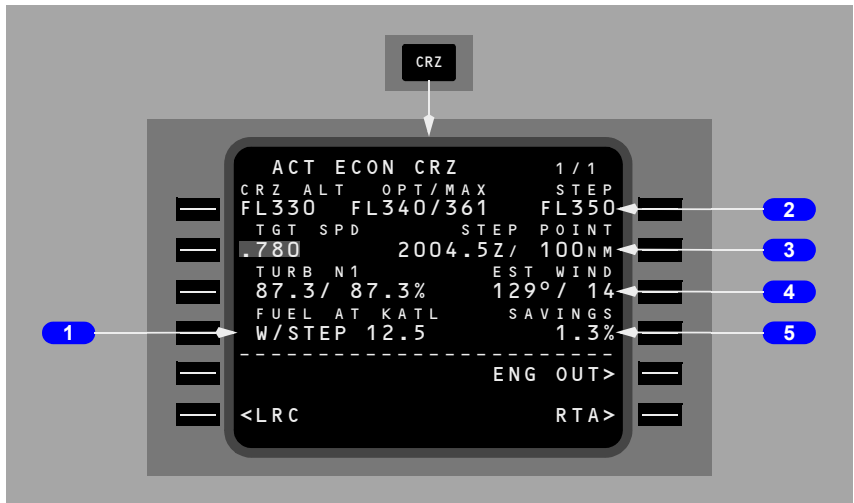

1 Fuel at Destination with Step Climb Altitude (FUEL AT XXXX)

The computation assumes the step climb will occur at the STEP point, and the value is prefixed by W/STEP.

2 Step To Altitude (STEP)

Used to enter step climb or step descent altitudes for crew evaluation.

Blank when within 100 nm of top of descent or when RTA mode is active.

3 STEP POINT

Displays the computed ETA at, and distance to, the first possible step climb point based on gross weight.

Blank if no entry on STEP TO line.

4 Wind (ACTUAL WIND or EST WIND)

Used as the assumed true wind at the STEP TO altitude for making wind–altitude trade computations.

5 Savings/Penalty (SAVINGS or PENALTY)

Displays the predicted cost savings or penalty associated with flying the displayed speed/altitude step climb or descent profile, as compared to flying the current cruise speed schedule and maintaining present altitude to top of descent.

Blank if no step data entered.

Cruise Climb

The cruise climb page displays data for a cruise climb to a new altitude.

MOD CRZ CLB is automatically displayed during cruise if a higher cruise altitude is entered on the CRZ page.

During VNAV operation, execution initiates a climb at climb thrust and cruise target speed to the new altitude.

The VNAV climb mode is active until reaching the selected altitude. The mode then automatically changes back to cruise.

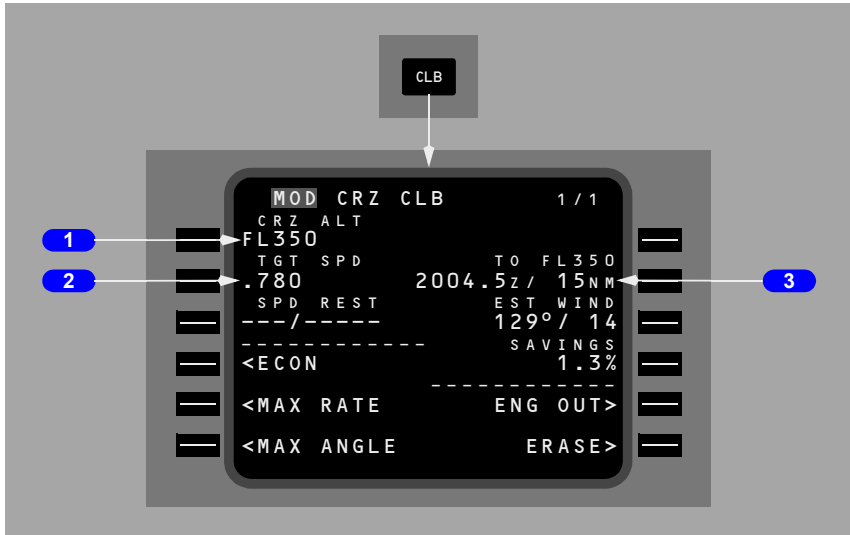

1 Cruise Altitude (CRZ ALT)

Initially displays the CRZ ALT entered on the CRZ page.

Manual entry may be made.

2 Target Speed (TGT SPD)

Displays target cruise speed for the displayed cruise altitude.

Manual entry may be made.

3 TO FLXXX

Displays ETA at, and distance to, the displayed cruise altitude.

RTA Cruise Climb

The RTA cruise climb page displays the same data as the cruise climb page except for the TIME ERROR line.

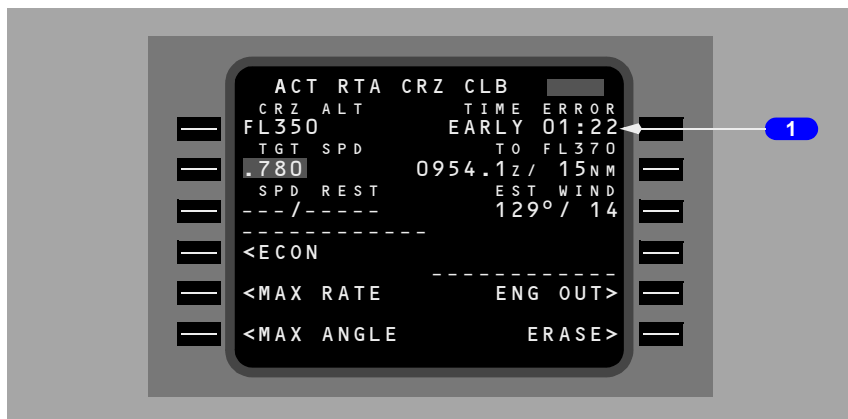

1 TIME ERROR

Displays the computed time error at the RTA waypoint.

Same as time error on RTA PROGRESS page.

Cruise Descent

The cruise descent page displays data for a cruise descent to a new altitude.

MOD CRZ DES is automatically displayed during cruise if a lower cruise altitude is entered on the CRZ page.

During VNAV operation, execution initiates a descent at 1,000 feet per minute and cruise target speed to the new altitude.

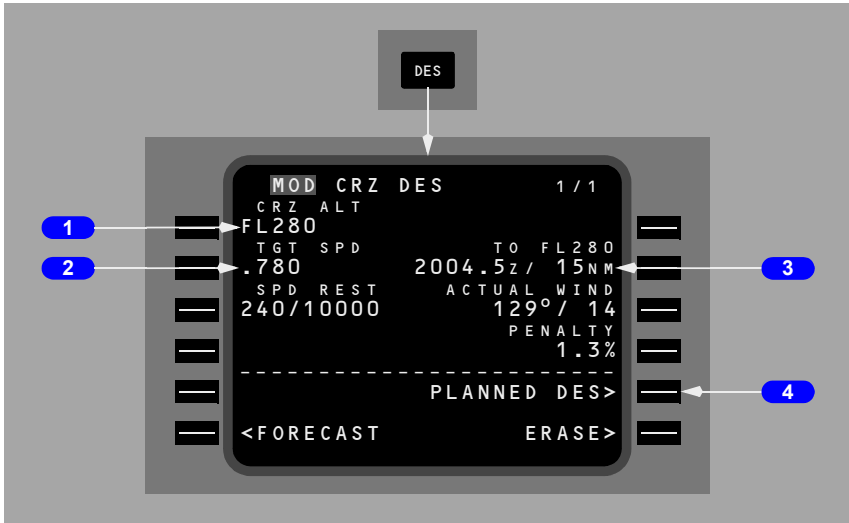

1 Cruise Altitude (CRZ ALT)

Initially displays the CRZ ALT entered on the CRZ page.

Manual entry may be made.

2 Target Speed (TGT SPD)

Displays target cruise speed for the displayed cruise altitude.

Manual entry may be made.

3 TO FLXXX

Displays ETA at, and distance to, the displayed cruise altitude.

4 Planned Descent (PLANNED DES)

Push – displays the planned DES page and allows access to the planned standard descent mode.

RTA Cruise Descent

The RTA cruise descent page displays the same data as the cruise descent page except for the TIME ERROR line.

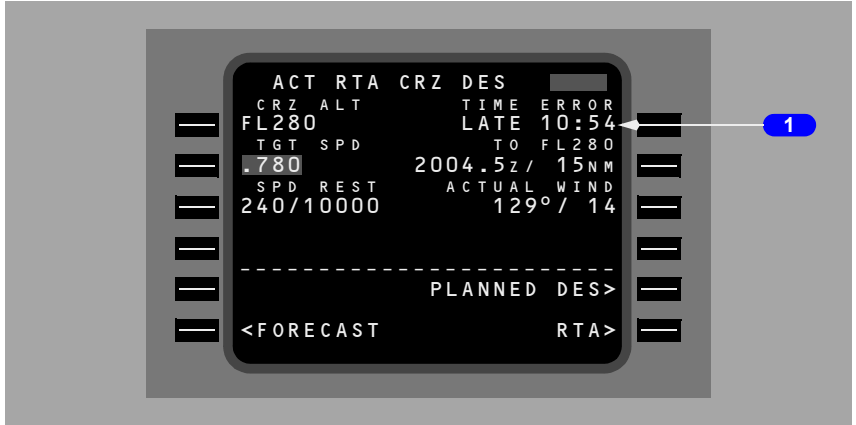

1 TIME ERROR

Displays the computed time error at the RTA waypoint.

Same as time error on RTA PROGRESS page.

Engine Out Cruise

The engine out cruise page may be accessed by selecting the ENG OUT prompt on the cruise page. The page displays advisory data for a one engine inoperative condition.

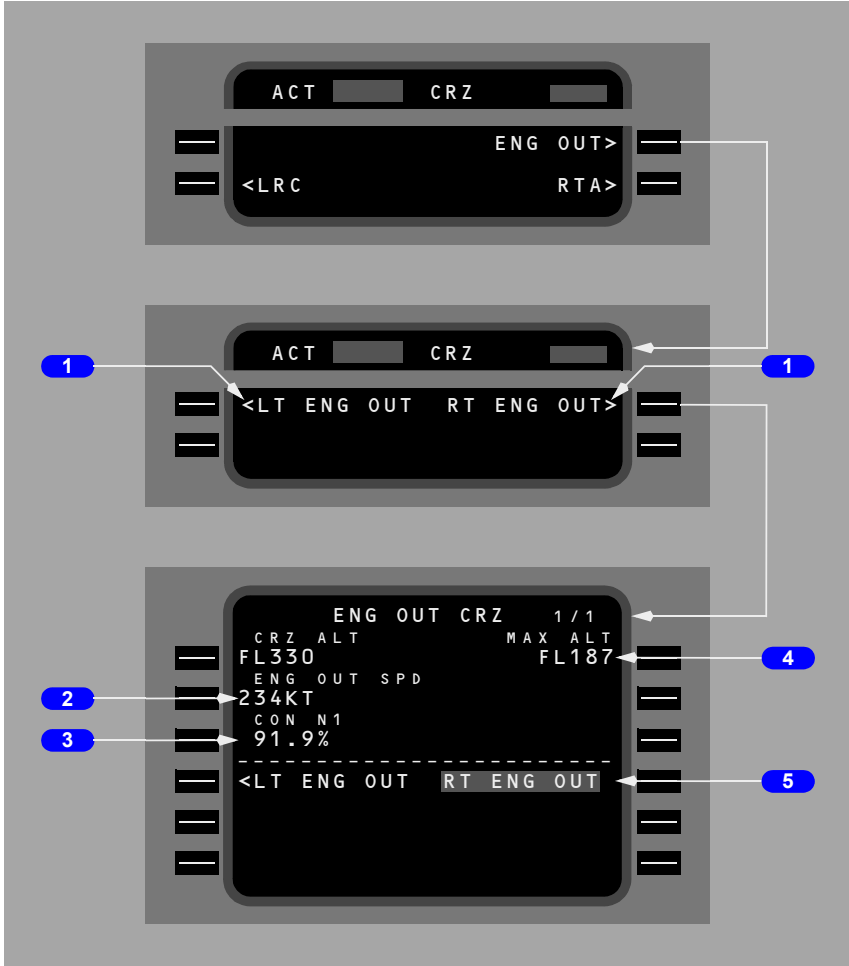

1 Left/Right Engine Out (LT ENG OUT/RT ENG OUT)

Selection changes display to ENG OUT CRZ page. The ENG OUT CRZ page is information only.

2 Engine Out Speed (ENG OUT SPD)

Displays the optimum speed based on minimum drag.

3 Continuous N1 (CON N1)

Displays N1 for maximum continuous thrust.

N1 is computed using actual bleed conditions.

4 Maximum Altitude (MAX ALT)

Displays the computed maximum altitude at which a company–specified rate of climb can be achieved, using one engine at maximum continuous thrust (default climb rate is 100 feet per minute).

After page selection, the FMC accounts for wing and engine anti–ice, air conditioning, and the engine bleed of the operating engine.

5 LT ENG OUT/RT ENG OUT

Selected engine is shown in reverse highlighting.

Early Descent

Early descents are initiated from the DES page. Once an early descent is executed, VNAV transitions to the descent mode and cruise features are no longer available.

For a path descent the DES NOW prompt will not be displayed until a descent path is established. Once executed, the autothrottle adjusts thrust to maintain 1000 feet per minute until intercepting the descent path.

For a speed descent, the autothrottle retards to idle and pitch maintains target speed.

1 Descend Now (DES NOW)

Selecting the PATH DES page before reaching the top of descent displays the normal descent page with the prompt DES NOW on the bottom right of the page. Selecting and executing the DES NOW prompt initiates a VNAV descent of 1000 feet per minute at ECON speed. Upon reaching the planned descent path, VNAV transitions to maintain the planned descent path.

Selecting the SPD DES page and executing the DES NOW prompt initiates a VNAV descent at idle thrust and target speed.

Route and Waypoint Data

Route Data (RTE DATA) Page

The RTE DATA page displays ETA for each waypoint on the RTE LEGS page. This page also displays forecast wind data for cruise waypoints.

One page displays data for five waypoints.



1 Waypoint

Displays the identifier for the waypoint from the ACT RTE LEGS page.

2 WIND

Used for entry and/or display of the true winds at the cruise waypoint identified on the same line.

Entry may be via the keyboard, or propagated from the CRZ WIND entry on the PERF INIT page.

The CRZ WIND value (075°/45 is depicted) propagates to all cruise waypoints (ABC to GHI is the depicted cruise segment).

If no CRZ WIND entry was made, the FMC assumes 000°/000.

A keyboard entry has priority and propagates to all down path cruise waypoints (an entry of 080°/140) at DEF is depicted). The entry must be executed.

737 Flight Crew Operations Manual

Any entries propagated from the CRZ WIND entry are displayed in small font. Keyboard entries are displayed in large font.

Crew entries of forecast winds (or default 000°/000) are automatically biased with the actual wind computed by the FMC when within 100 NM of a cruise waypoint and within 2000 feet of a cruise altitude. Biased values are not displayed.

Blank for non-cruise waypoints (VERNO and JKL are depicted). Entry is inhibited.

3 Estimated Time of Arrival (ETA)

Displays the FMC calculated waypoint ETA.

4 LEGS

Push – displays the RTE LEGS page.

5 WINDS REQUEST

Push – transmits a data link request for winds uplink.

Position Shift Page 3/3

On the POS SHIFT page, each prompt indicates the bearing and distance of the indicated system relative to the FMC position. FMC position is displayed on line 1R of POS REF page 2/3. The entries with parentheses in the center of the page show the active position references.

Data fields are blank when on the ground.

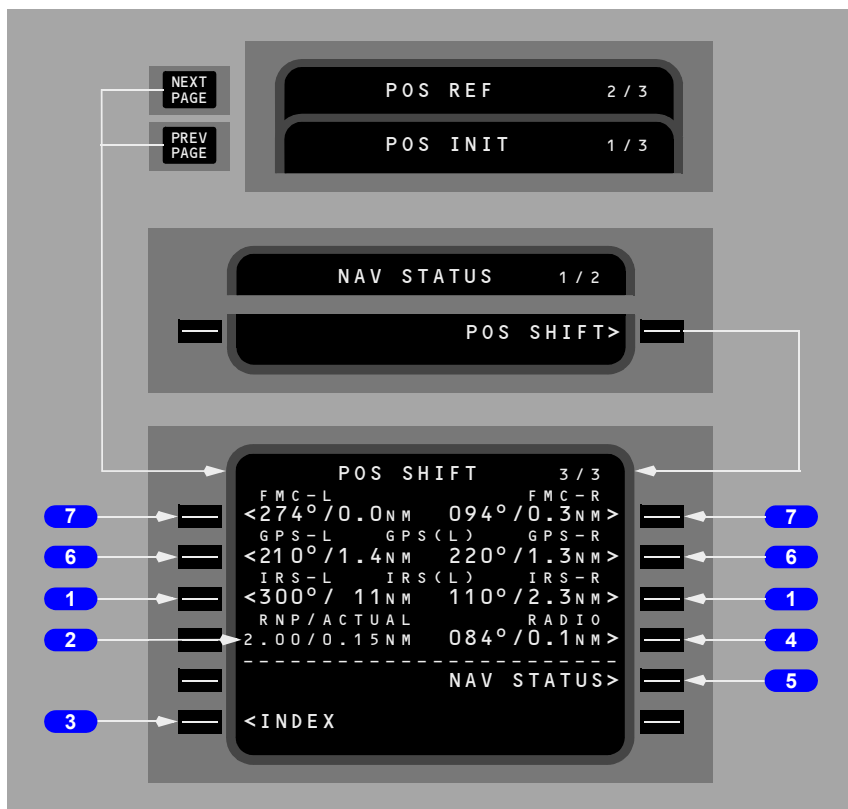

1 IRS Position L/R

Displays left and right IRS position relative to FMC position using current mag/true reference. Blank if IRS position is invalid.

Push – highlights the line, illuminates the EXEC key, and displays the CANCEL prompt.

2 Required Navigation Position/Actual (RNP/ACTUAL)

Displays the required navigation accuracy compared to actual navigation accuracy.

737 Flight Crew Operations Manual

Manual entry is allowed.

3 INDEX

Push – displays the INIT/REF INDEX page.

4 RADIO Position

Displays radio position relative to FMC position using current mag/true reference. Blank if radio position is invalid.

Push – highlights the line, illuminates the EXEC key, and displays the CANCEL prompt.

5 Navigation Status (NAV STATUS)

Push – displays the NAV STATUS page.

6 GPS Position L/R

Displays left and right GPS position relative to FMC position using current mag/true reference. Blank if GPS position is invalid.

Push – highlights the line, illuminates the EXEC key, and displays the CANCEL prompt.

7 FMC Position L/R

Displays left and right FMC position relative to FMC position using current mag/true reference. Blank if FMC position is invalid.

Push – highlights the line, illuminates the EXEC key, and displays the CANCEL prompt.

Inflight Position Update

FMC position update is accomplished on the POS SHIFT 3/3 page in flight. Selecting a prompt stops the updating of the relative position. The selection is highlighted, the associated caret is removed, the execute key is illuminated, and the CANCEL prompt is displayed in line 6R.

When the position shift is executed, UPDATE COMPLETE is displayed.

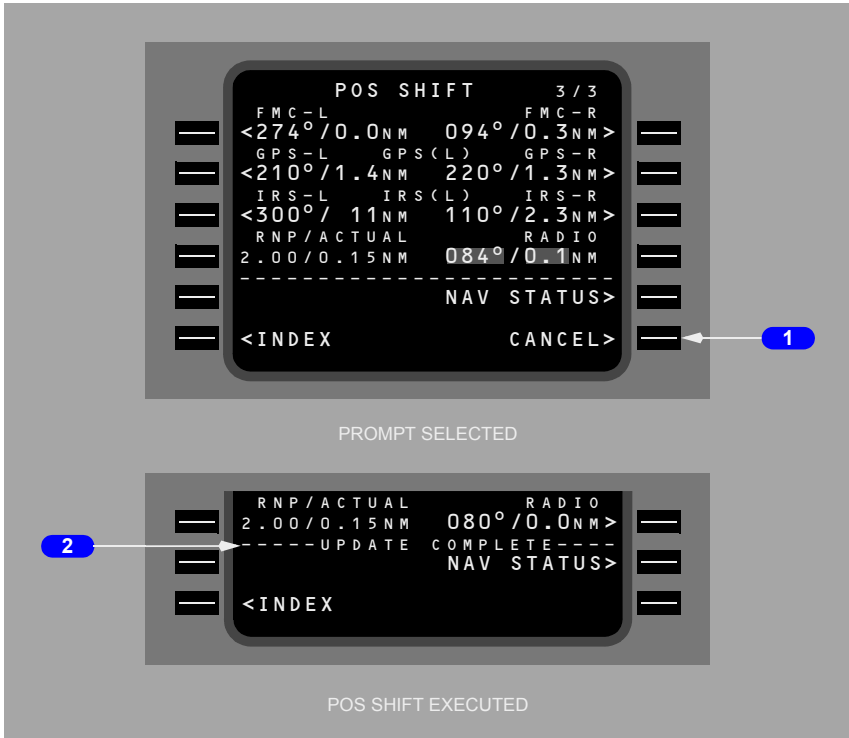

1 CANCEL

Displayed when a line selection is made for position update.

Push – prior to execution cancels the line selection.

2 UPDATE COMPLETE

Displayed after a position shift has been selected and executed.

Navigation Data

Reference Navigation Data (REF NAV DATA) Page

The reference navigation data page provides information about waypoints, navaids, airports, and runways. Entering the appropriate identifier initiates the display. Writing SUPP in the scratch pad prior to selecting NAV DATA results in display of the supplemental navigation data (SUPP NAV DATA) page.

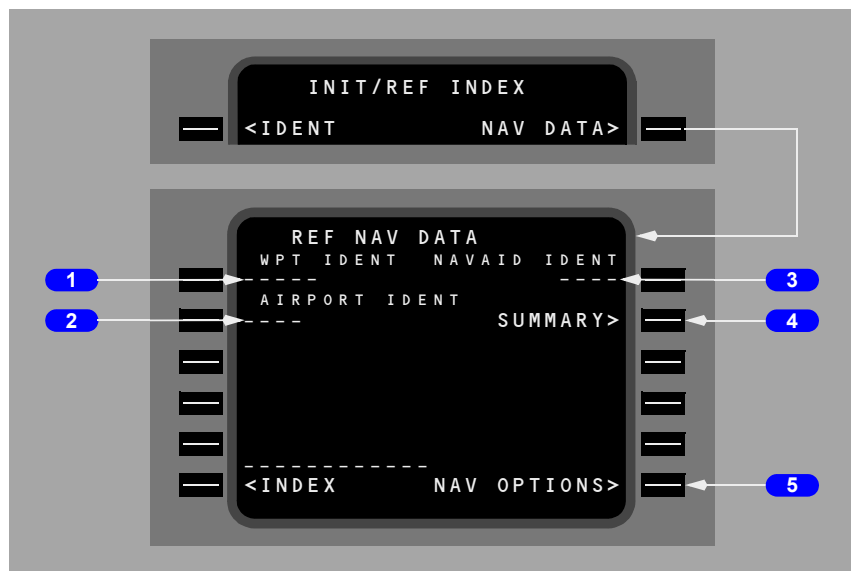

1 Waypoint Identifier (WPT IDENT)

Displays dashes initially.

Any waypoint, navaid or runway can be entered.

Format for runway entry is “RWnna” where “nn” is a one or two digit numeric (with or without leading zeros) and “a” is an optional character L, R, or C.

In order to access runway data, an airport must be identified.

2 Airport Identifier (AIRPORT IDENT)

Displays dashes initially.

Displays box prompts if runway is entered into 1L prior to airport entry.

An invalid airport/runway pair will result in “NOT IN DATA BASE” displayed in the scratchpad.

3 Navigation Aid Identifier (NAVAID IDENT)

Displays dashes initially.

Valid entries are up to 4 alphanumeric characters.

If the navaid is not contained in the databases, box prompts will appear in related data fields needing entry.

4 SUMMARY

Push – displays NAV SUMMARY pages.

Blank if supplemental and temporary databases are empty.

5 Navigation Options (NAV OPTIONS)

Push – displays NAV OPTIONS page.

If the entered identifier is already stored in the permanent, supplemental, or temporary database, then relevant data propagates to the subsequent REF NAV DATA display.

If the entered identifier is not stored in any database, the subsequent REF NAV DATA display contains box prompts. Following entry of the required information, the new data may be stored in the temporary database by executing (except for runway data). Data may be subsequently deleted from the temporary database by deleting the individual identifier, if the identifier is not presently being displayed on another page (e.g., RTE LEGS, PROGRESS, etc.).

All data stored in the temporary database is cleared at flight completion.

Waypoint Data Display

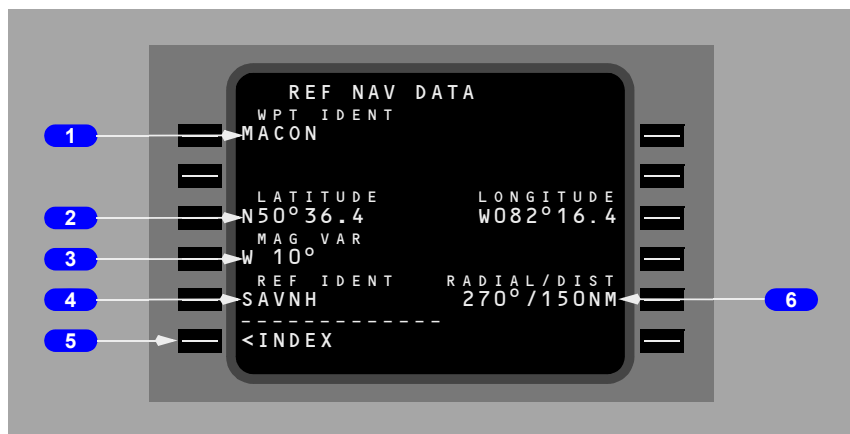

1 Waypoint Identifier (WPT IDENT)

Displays or permits entry of the desired waypoint. When this entry is complete, the associated data lines are displayed.

2 LATITUDE/LONGITUDE

Displays or permits entry of waypoint latitude and longitude. Entry on the REF IDENT and RADIAL/DIST lines cause latitude and longitude to be computed and displayed.

3 Magnetic Variation (MAG VAR)

Displays or permits entry of waypoint magnetic variation. Data is automatically computed based on latitude and longitude.

Manual entry has priority.

4 Reference Identifier (REF IDENT)

Together with RADIAL/DIST, displays or permits entry of reference point for a created waypoint.

5 INDEX

Push – displays REF NAV DATA page.

6 Radial/Distance (RADIAL/DIST)

Together with REF IDENT, displays or permits entry of bearing and distance for a created waypoint.

Navigation Aid Data Display

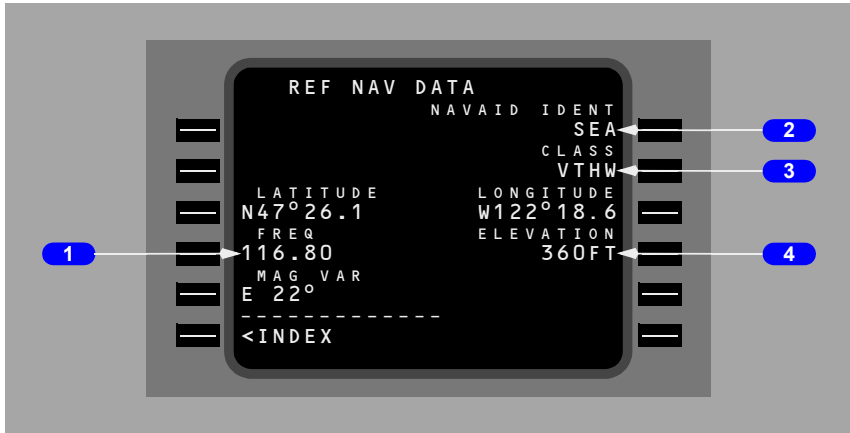

1 Frequency (FREQ)

Displays or permits entry of the frequency of the entered navaid.

2 Navigation Aid Identifier (NAVAID IDENT)

Displays or permits entry of navaid identifier (5 characters maximum). Following entry, the associated data lines are displayed.

3 Classification (CLASS)

Displays or permits entry of the classification of the entered navaid.

4 ELEVATION

Displays or permits entry of the elevation (feet above MSL) of the entered navaid.

Airport Data Display

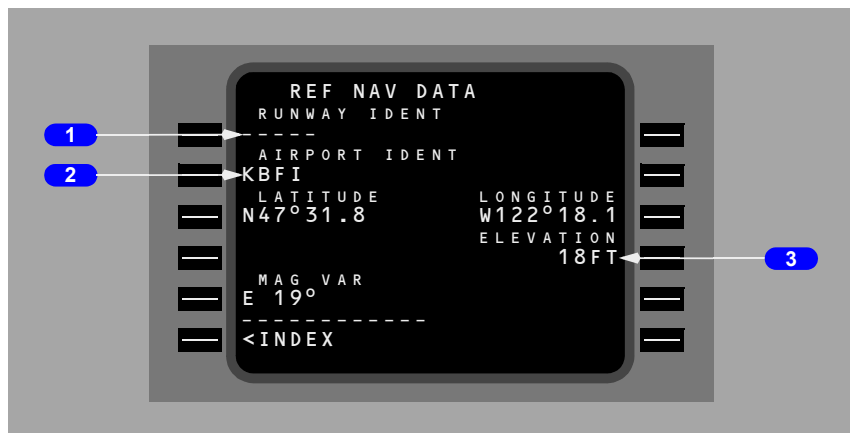

1 Runway Identifier (RUNWAY IDENT)

Permits entry of runway identifier.

2 Airport Identifier (AIRPORT IDENT)

Displays airport identifier.

3 ELEVATION

Displays or permits entry of the elevation (feet above MSL) of the entered airport.

Runway Data Display

A runway identifier may be entered on the airport data display page or as a waypoint on the REF NAV DATA page. On the airport data display page, entry may be in the form of 13R or RW13R. Single digit entries are possible, with or without leading zeros. If the waypoint method is used, entry must be in the form RW13R, and the proper airport identifier must be entered on the runway data display page. Runways must be stored in the permanent navigation database.

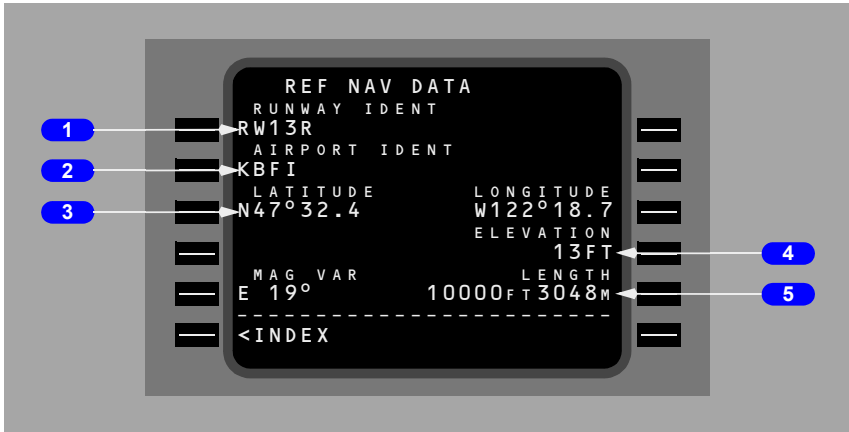

1 Runway Identifier (RUNWAY IDENT)

Displays runway identifier.

2 Airport Identifier (AIRPORT IDENT)

Displays airport identifier.

3 LATITUDE/LONGITUDE

Displays latitude and longitude of entered runway.

4 ELEVATION

Displays elevation (feet above MSL) of the entered runway.

5 Runway Length (LENGTH)

Displays length of entered runway in feet and meters.

Navigation Summary (NAV SUMMARY)

The NAV SUMMARY pages show the contents of the temporary and supplemental navigation databases. Contents of the temporary navigation database show first, followed by contents of the supplemental navigation database.

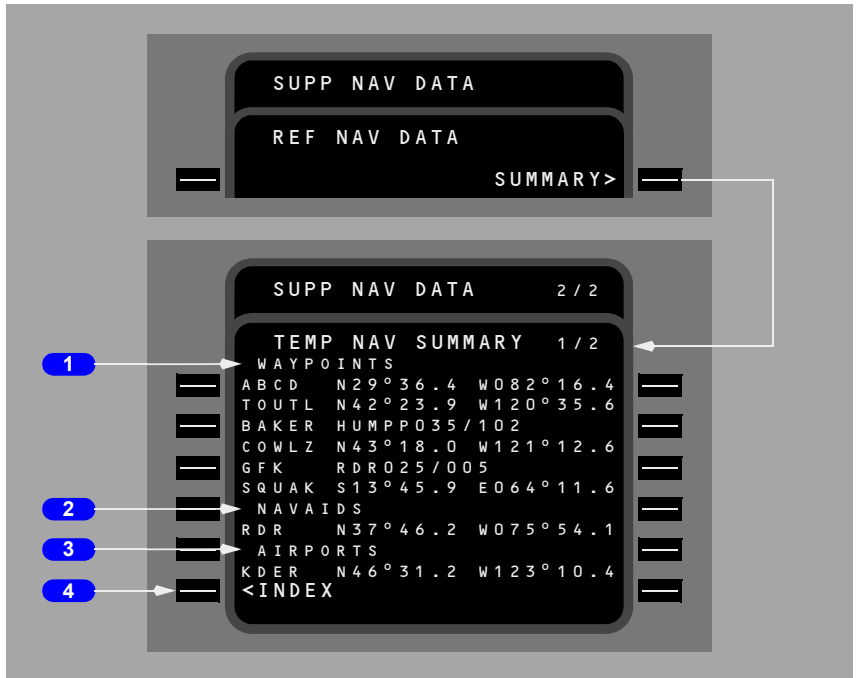

1 WAYPOINTS

Shows waypoints stored in related database.

Waypoints show in defining format.

2 NAVAIDS

Shows navaids stored in related database.

3 AIRPORTS

Shows airports stored in related database.

4 INDEX

Push – shows page (REF NAV DATA or SUPP NAV DATA) used to access NAV SUMMARY pages.

Supplemental Nav Data

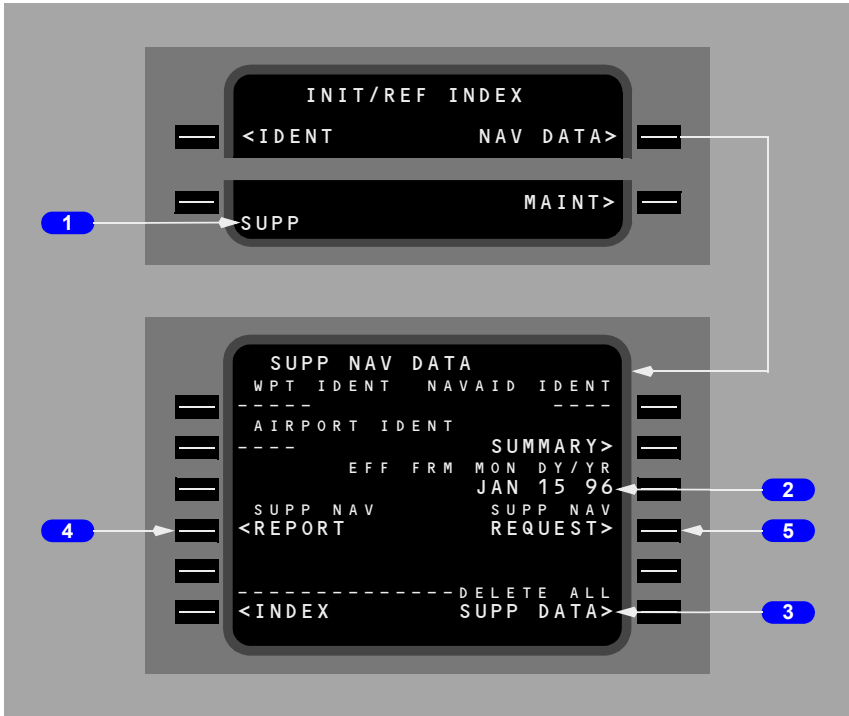

1 SUPP Scratchpad Entry

The supplemental navigation database is accessed by typing SUPP in the scratchpad while on the INIT/REF INDEX page, then selecting the NAV DATA prompt. Access is only available on the ground.

2 Effectivity Date (EFF FRM MON DY/YR)

Allows entry of month, day, and year that the supplemental database becomes valid. The date will be displayed on IDENT page 1/2 after entry. Box prompts are displayed if an effectivity date is not entered.

3 Delete All Supplemental Data (DELETE ALL SUPP DATA)

Data may be deleted from the supplemental database by two methods. Deletion may be accomplished one item at a time on the display pages, or the entire database may be deleted by selecting this prompt. The prompt is only available before entry of an origin airport.

4 SUPP NAV REPORT

Push – transmits a copy of supplemental navigation database.

5 SUPP NAV REQUEST

Push – transmits a data link request for a supplemental navigation database uplink.

Navigation Status Display

The NAV STATUS page displays the current status of the navaids being tuned.

Access to the NAV STATUS display is from the NAV STATUS prompt on the POS SHIFT page 3/3, the PROGRESS page 1/3, and (in flight) the INIT/REF INDEX page or from the NAV OPTIONS page 2/2, NEXT or PREV PAGE.

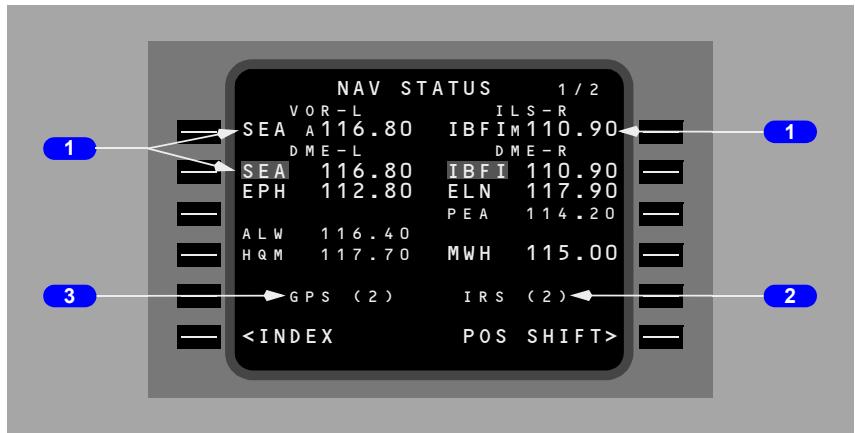

1 VOR/ILS and DME Lines

Lines 1L and 1R display VOR or ILS identifier and frequency tuned on the corresponding VHF NAV control panel.

Lines 2L – 2R through 4L – 4R display up to five DME identifiers and frequencies tuned by the corresponding scanning DME receiver.

Data is displayed in large font with the identifier highlighted if that facility is being used for navigation.

Data is displayed in large font with the identifier not highlighted if that facility is being received but not used for navigation.

Data is displayed in small font if that facility is being tuned but not received.

If the navaid has failed, FAIL will be displayed in small font.

If there is no corresponding identifier for the displayed frequency, then the identifier field will be blank and only the frequency will be displayed.

On lines 1L or 1R, for VOR/ILS displays, the mode of tuning will be shown:

- M – Manual
- P – Procedural
- A – Automatic.

On lines 2L – 2R through 4L – 4R, if no DME information is received then the identifier and frequency field is blank.

2 IRS Status Display

Displays the IRS currently selected for use in navigation. “L” or “R” indicates left or right IRS is being used in the FMC position calculation.

“2” indicates a dual system with both IRSs used in the FMC position calculation.

3 GPS Status Display

Displays the GPS currently selected for use in navigation. “L” or “R” indicates left or right GPS is being used in the FMC position calculation.

“2” indicates dual system with both GPSs used in the FMC position calculation.

The display will be blank if GPS is inhibited for use in navigation.

Navigation Options (NAV OPTIONS)

The FMC normally rejects the use of navaids that are not suitable for navigation. However, when the aircrew is aware that unreliable navaids exist (either by NOTAM, ATC, etc.) they should manually exclude these navaids from the FMCs navigation solution. This will prevent the possibility of incorrect position calculations and maximize the FMCs reliability. This is accomplished through the NAV OPTIONS page.

Access to the NAV OPTIONS page may be gained by selecting the NAV OPTIONS prompt on the REF NAV DATA page or by selecting NEXT or PREV PAGE on the NAV STATUS page.

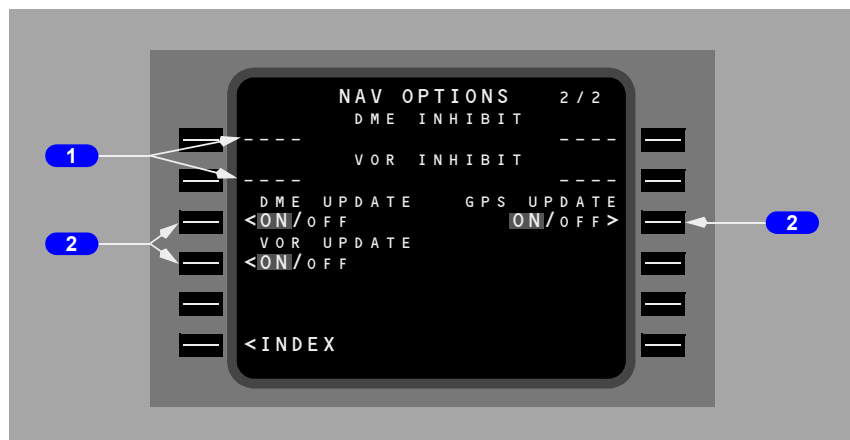

1 DME/VOR INHIBIT

Enter the identifier of up to two VOR/DME, VORTAC, or DME stations that must not be used for FMC position updates.

Entries are blanked at flight completion.

Deleting or overwriting removes a previous inhibit.

The FMC normally uses DME from two different ground stations to update its position solution. When two DME stations are not available, the FMC reverts to single station radial-DME updating to determine position. Only two of the four inhibit entries are utilized at any one time depending upon which update mode the FMC is operating in. The DME INHIBIT entries are excluded from the FMCs update solution whenever the FMC is updating from two DME stations. The VOR INHIBIT entries are excluded from the FMCs update solution whenever the FMC is radial-DME updating.

2 DME/VOR/GPS UPDATE

Push – permits switching between ON and OFF modes for updating FMC position. Default mode is ON. The current mode is highlighted.

Selection is reset to ON at flight completion.

Fix Information Page

Two identical FIX INFO pages are used to identify waypoint fixes for display on the navigation display map mode. If desired, fix information can be copied into the route. Page access is via the FIX key.

Radial or distance entries from the fix may be made on any line 2L to 4L. Valid format is a three character numeric entry. Slash rule is used to differentiate between radial and distance in the scratch pad.

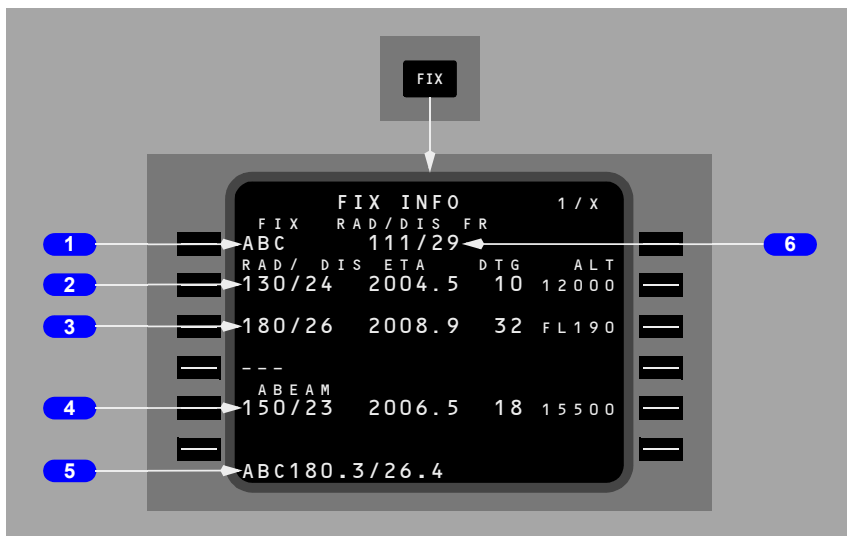

1 FIX Name

Enter the desired fix.

Valid entries are airports, navaids, waypoints or runway identifiers from the navigation database.

The selected fix is displayed on the navigation display map mode and highlighted by a green circle.

2 Distance Entry (example)

Enter a distance from the fix. Distances from the fix are displayed on the navigation display map mode as a dashed green circle around the fix.

737 Flight Crew Operations Manual

When the distance intersects the active route, the ETA, DTG, and predicted altitude at the intersection are displayed for that intersection.

If there is more than one intersection, the data will apply to the first occurrence and will sequence as each intersection is passed.

Valid entries are xxx.x:

- distance is limited to 511 NM or less and may contain 1/10 NM entry
- leading zeros can be omitted for distance
- decimal values can be omitted
- distance only entries must start with a /.

ETA – displays the estimated time of arrival to the intersection point.

DTG – displays the distance to go to the intersection point.

ALT – displays the predicted altitude at the intersection point.

3 Radial Entry (example)

Enter a radial from the fix. Radials are displayed on the navigation display map mode as green dashed lines from the fix.

When the radial intersects the active route, the ETA, DTG, and predicted altitude at the intersection are displayed.

If there is more than one intersection, the data will apply to the first occurrence and will sequence as each intersection is passed.

Valid entries are xxx or xxx/.

4 ABEAM

Displays the abeam point and calculates the ETA, DTG, and ALT information.

The fix abeam point ahead of the airplane is displayed by a radial line from the waypoint ending at the nearest perpendicular route leg intersection.

If there is more than one intersection, the data will apply to the first occurrence and will sequence as each intersection is passed.

5 Route Intersection Point Copied

Pushing the line select key for one of the RAD/DIS entries copies the fix place/bearing/distance definition into the scratchpad. This fix can be placed into the route on a LEGS page as a waypoint.

6 Radial/Distance From Fix (RAD/DIS FR)

Displays the radial and distance from the fix to the airplane. This information is continually updated as the airplane position changes.



Intentionally
Blank



Introduction

The descent phase begins at the top of descent point and continues to the end of descent point. Planning for the descent phase begins during cruise.

The approach phase begins at the end of descent point and continues to touchdown or go-around. When a go-around is accomplished, the FMC enters the cruise phase.

The only automatic page change provided in the descent/approach modes is the transition from cruise to descent at the top of descent.

Early Descent

Early descent may be commenced prior to reaching the top of descent by using the DES NOW prompt.

Descent

During descent, LNAV progress is managed using the RTE LEGS and PROGRESS pages, as in the cruise phase. VNAV descent management is accomplished primarily on the DES page.

The DES FORECASTS page is also available to enter forecast wind data to aid in descent planning.

Descent Page (During Cruise)

The descent page is used to monitor, revise, or select the descent path. Descent modes are economy (ECON) path or speed and manual path or speed. The default VNAV descent mode is ECON PATH. The crew must select a manual speed descent mode.

The page title reflects the VNAV descent mode. The path mode controls descent to fly a vertical path which complies with altitude and speed restrictions in the flight plan. The speed mode controls descent at a fixed speed and complies with altitude and speed restrictions in the flight plan.

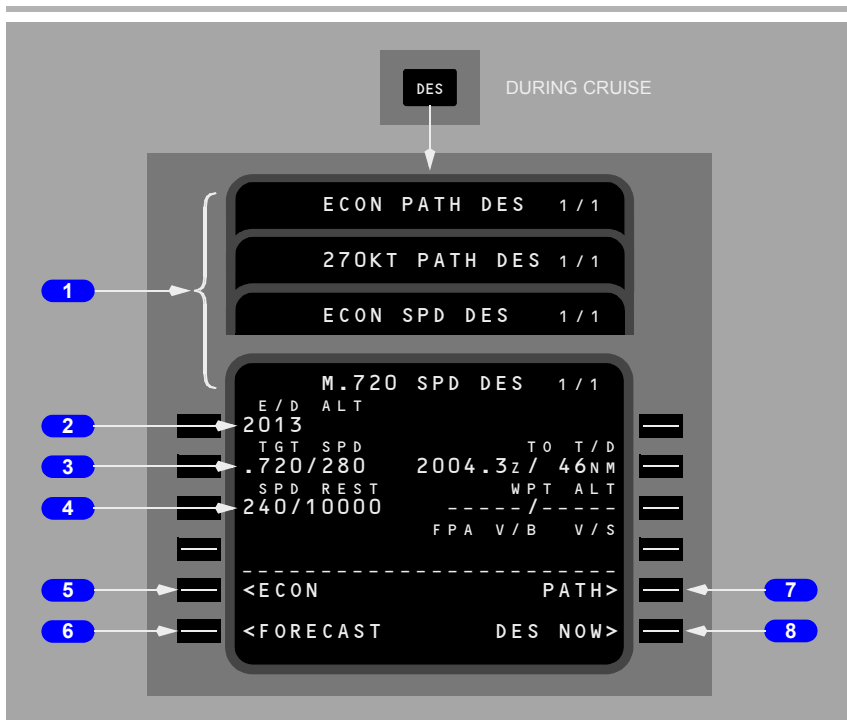

1 Page Title

The page title identifies the selected mode. When a manual speed is selected, the title includes XXXKT for fixed CAS or M.XXX for fixed Mach selections.

Displays ACT when the descent phase is active.

2 End of Descent Altitude (E/D ALT)

Displays the end of descent altitude.

- for a PATH DES page, displays the altitude restriction for the E/D waypoint; blank if path descent not available
- for a SPD DES page, displays the altitude restriction for the E/D waypoint, if an E/D waypoint is present
- if an approach is selected which ends at RWXXXX, the E/D altitude will be Threshold Crossing Height (TCH), 50 feet above the runway.

YA371 - YC206, YE321 - YE326

The end of descent altitude is the last of the following not preceded by a lateral discontinuity:

- glideslope intercept point or FAF for approaches other than ILS or GLS
- the AT altitude constraint including the runway threshold altitude

737 Flight Crew Operations Manual

- threshold crossing height for the runway
- the missed approach point (MA-XX) altitude constraint.

YC207

The end of descent altitude is the altitude constraint or predicted altitude of the last descent waypoint. End of descent may follow a lateral discontinuity. If a lateral discontinuity exists, the FMC will construct a great circle path across the discontinuity and VNAV shall be valid while flying the discontinuity.

3 Target Speed (TGT SPD)

Displays the command speed maintained by VNAV while descending to waypoints, constraints, or speed restrictions.

On ECON PATH or ECON SPD DES pages, displays the computed values for target Mach and airspeed. Speeds are performance limited.

Manual entries may be made and cause the manual PATH or manual SPD DES page for that value to display (M.720 SPD DES is depicted).

Blank for any PATH DES page if a path descent is not available.

4 Speed Restriction (SPD REST)

Displays the most restrictive of the following speeds:

- destination airport speed minus 10 knots
- waypoint speed restriction if greater than minimum flaps up maneuvering speed
- minimum flaps up maneuvering speed
- selected Vref + wind correction for landing flap setting
- whenever flaps are extended, the, appropriate flap speed shall be displayed as XXX/FLAPS. This shall supersede any other speed restriction
- displays XXX/HOLD when decelerating to hold speed prior to hold entry fix.

Dash prompts displayed when there is no active speed restriction.

Manual crew entries or deletions may be made. HOLD or FLAPS speed may not be deleted or modified.

5 Economy (ECON)

Displayed on the manual DES pages.

Push – selects the corresponding ECON SPD or ECON PATH DES page.

6 Descent Forecasts (FORECAST)

Push – selects the DES FORECASTS page.

7 PATH

Displayed on the SPD DES pages if a path descent is available.

Push – selects the corresponding PATH DES page.

8 Descend Now (DES NOW)

Displayed on the standard DES pages whenever descent is not ACT or MOD.

Blank for any PATH DES page if a path descent is not available.

Push – arms the DES NOW function and illuminates the EXEC light.

On a PATH DES page, execution allows early initiation of PATH descent at 1000 fpm until intercepting the computed path. On a SPD DES page, execution allows early initiation of a SPD descent at the specified speed (ECON or manual).

Descent Page (During Descent)

Display when any descent mode is active after beginning of descent.

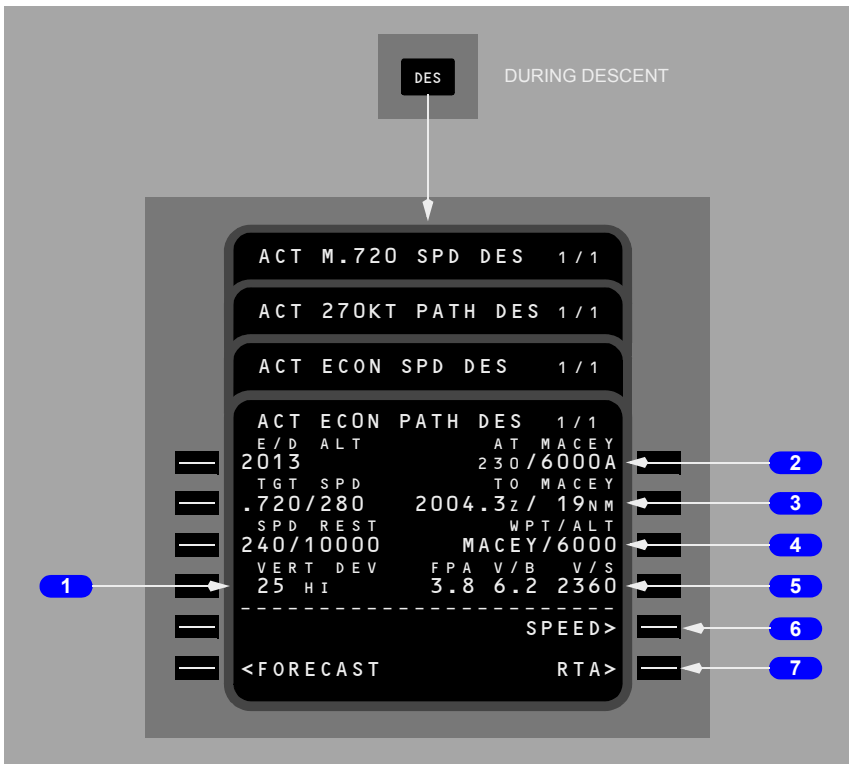

1 Vertical Deviation (VERT DEV)

Displays present deviation (feet HI or LO) from the computed vertical path.

The deviation is always in relation to the path descent profile, regardless of which page is active (PATH DES or SPD DES).

Blank if a path is not available.

2 Altitude Restriction (AT XXXXX)

Displays the next waypoint constraint from the RTE LEGS page.

The constraint is speed/altitude. If an airspeed restriction exists at the waypoint, it will be displayed in large font; otherwise the predicted speed will be displayed in small font.

Can be deleted on this page.

The display is blank when no constraint exists, or for any PATH DES page if a path descent is not available.

3 To Waypoint (TO XXXXX)

Displays computed ETA and distance to go to T/D when not in an active descent mode.

If an early descent is in progress (initiated using DES NOW prompt), ETA and distance to go to original T/D is displayed until passing the T/D.

If a descent mode is active, displays ETA and distance to go to the first of the following points:

- the waypoint in the AT XXXXX line
- an intermediate T/D (TO T/D – XXXXX, where XXXXX is the altitude).

The display is blank if a path descent is not available, or if the AT XXXXX line is blank and no T/D information is displayed.

4 Waypoint/Altitude (WPT/ALT)

Displays the waypoint and altitude that serves as the basis for the vertical bearing (V/B) display on line 4R.

Normally displays the same waypoint/altitude restriction that is displayed on the AT XXXXX line.

May be overwritten by pilot entry.

A runway identifier may be entered for a runway at the destination airport of the displayed flight plan. Format may be either RWXX/, RWXXX/, RWXX/AA, or RWXXX/AA where XX or XXX is the runway designation and AA is the altitude. When RWXX/ or RWXXX/ is used the altitude will automatically be set to runway elevation plus threshold crossing height.

Dash prompts are displayed if there is no entry.

5 Vertical Path Parameters (FPA V/B V/S)

Displays the following parameters related to the present vertical path:

- FPA – actual flight path angle based on present ground speed and vertical speed (that is, the present vertical bearing being flown)
- V/B – vertical bearing direct from present position on the WPT/ALT line (that is, the flight path angle required if flying direct to the waypoint and altitude on the WPT/ALT line).
- V/S – the required vertical speed (in fpm, based on present ground speed) to fly the displayed V/B.

Blank if no entry on the WPT/ALT line.

6 SPEED

Displayed on PATH DES pages.

Push – selects the related SPD DES page.

7 RTA

Displayed when DES NOW or ERASE prompt is not displayed.

Push – selects the RTA PROGRESS page.

RTA Descent Page

RTA Descent pages are displayed when an RTA mode is active. Displays are the same as on other descent pages except as noted.

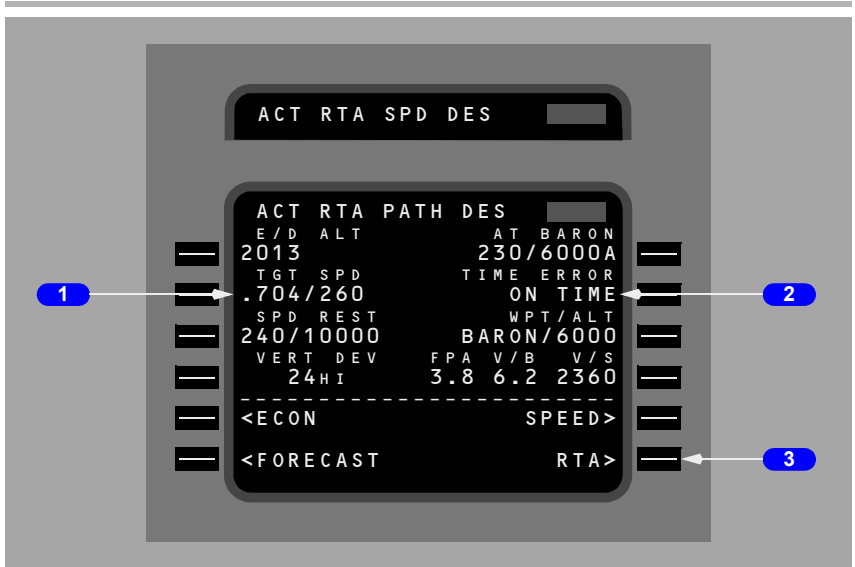

1 Target Speed (TGT SPD)

Displays computed RTA target speed.

Changes to FMC target speed if the RTA mode is exited.

2 TIME ERROR

Displays computed time error at the RTA waypoint.

Same as time error line on RTA PROGRESS page.

3 RTA

Push – selects the RTA PROGRESS page.

737 Flight Crew Operations Manual

Entries may be made in any altitude sequence and will be automatically ordered by altitude from highest to lowest.

Data may be up-linked via ACARS message. The up-linked value will appear in small font until EXECuted at which time it will be displayed in large font.

4 Thermal Anti-Ice On/Off (TAI ON/OFF)

Enter the altitudes in flight level or feet at which anti-ice is expected to be turned on and off. This entry is informational only and has no effect on aircraft operation.

Data may be up-linked via ACARS message. The up-linked value will appear in small font until EXECuted at which time it will be displayed in large font.

5 ISA Deviation and QNH (DEV/QNH)

Enter the average ISA deviation for descent in °C (+/-XX°C) or °F (+/-XX°F)

Enter the destination QNH altimeter setting (IN. HG. or MB). Do not enter a QFE altimeter setting.

Data may be up-linked via ACARS message. The up-linked value will appear in small font until EXECuted at which time it will be displayed in large font.

6 ERASE or LOAD

Push – (ERASE) deletes modification and returns page to previously displayed descent page.

Push – (LOAD) initiates the loading of ACARS up-linked descent forecasts data.

LOAD is displayed when ACARS descent forecasts has the highest load priority and no EXECutes or ACCEPT/REJECTs are pending.

7 DES WINDS REQUEST

Push – transmits a data link request for descent winds.

Engine Out Descent

There are no specific engine out pages for descent. Use the normal descent planning features and pages.

Approach

During approach, LNAV and VNAV guidance normally transitions to the approach guidance provided by navigation radios. The FMC continues to calculate and display present position and can provide LNAV and VNAV approach guidance for certain types of approaches when radio navigation is not used.

The RTE LEGS and PROGRESS pages are used to manage the airplane until other approach guidance becomes active. Other pages which support approaches are:

- APPROACH REF page – to select the approach VREF
- ARRIVALS page – to select the desired arrival and approach procedures
- HOLD page – to manage holding patterns.

Holding is described in this section but it can be used during any phase of flight.

Arrivals Page – IFR Approaches

The arrivals page allows selection of an approach, standard terminal arrival route (STAR), and arrival transitions to the destination airport. This page can also be used to view information about a selected airport that is not the destination. Only procedures for the origin and destination airport can be selected for entry into the flight plan.

The approaches, STARS/profile descents, and transitions are displayed and selected on this page.

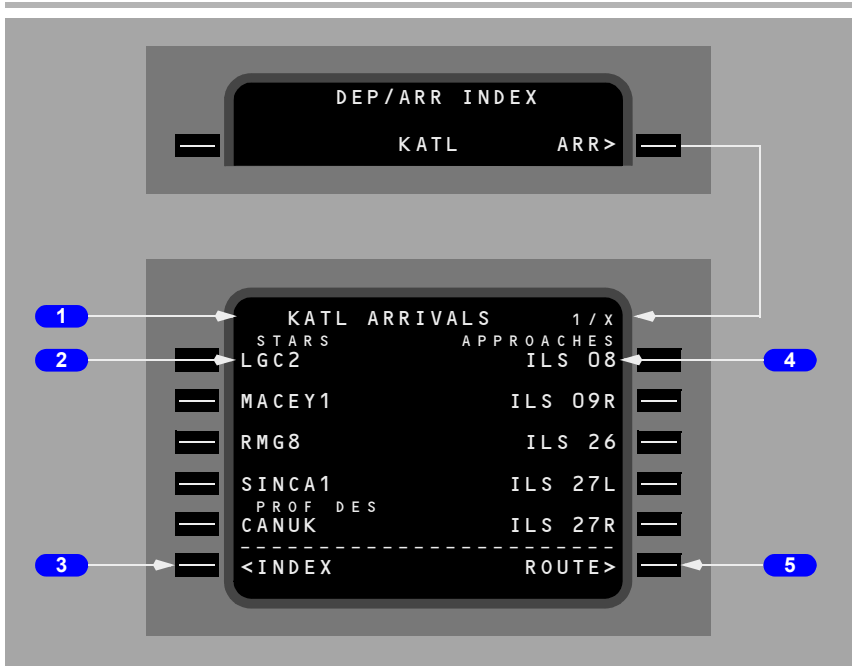

1 Page Title

The destination airport identifier is displayed in the title.

Airports with more than 5 runways or STARs produce multiple arrivals pages.

2 Standard Terminal Arrival Routes (STARs)

Upon initial selection, an alphabetical listing of all STARs and profile descents is displayed.

STARs are displayed first in a list under the STAR label. Profile descents are listed after the STARs under the PROF DES label.

Selection of the desired STAR deletes all other STARs and non-applicable approaches/runways, and displays a listing of any arrival transitions applicable to that STAR.

The selection of an approach or runway deletes all STARs not related to that approach/runway.

3 INDEX

Push – displays the DEP/ARR INDEX page.

4 Approaches and Runways (APPROACHES)

Upon initial page display, an alphabetical listing of all approaches for the airport, followed by a numerical listing of all runways, is displayed.

Selection of the desired approach or runway deletes all other approaches/runways.

5 ROUTE

Push – displays the RTE page.

737 Flight Crew Operations Manual

Arrivals Page during approach selection

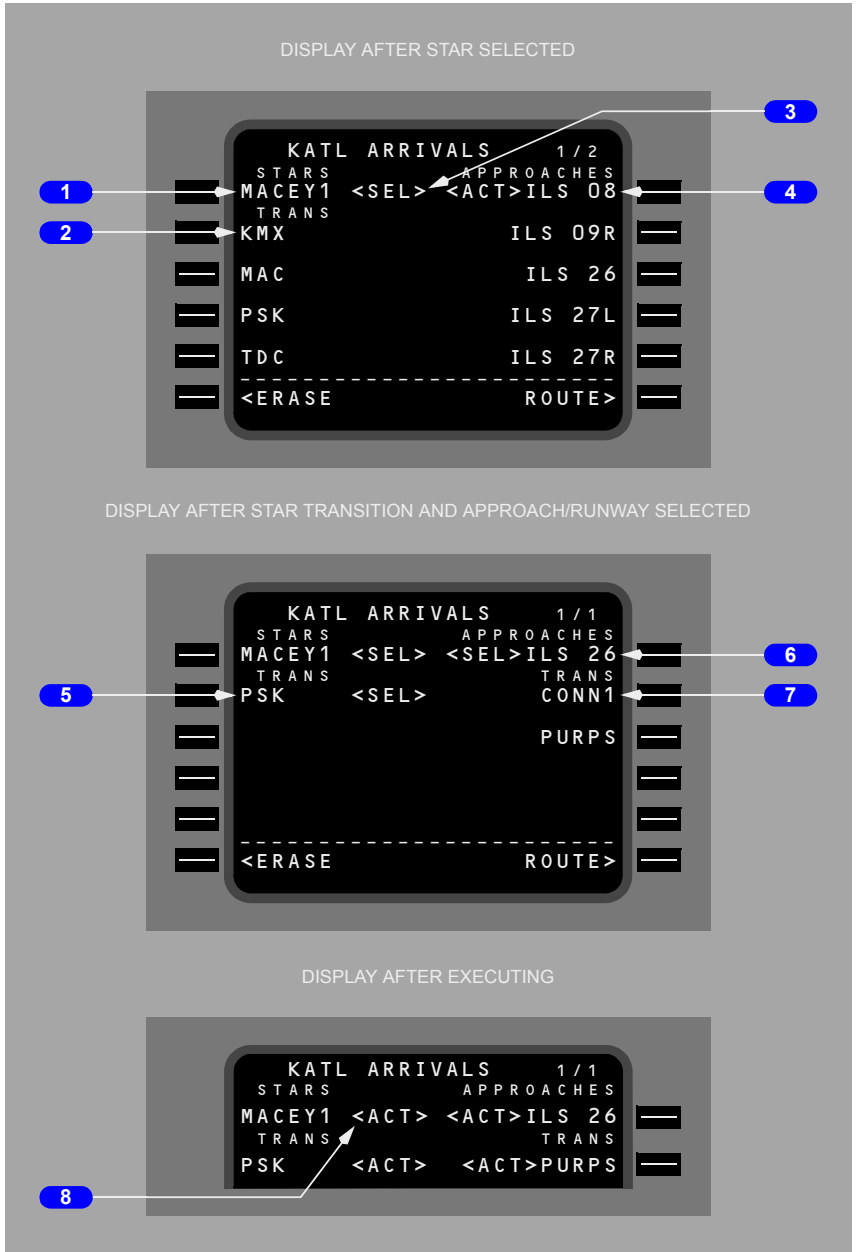

1 STARS

Displays the selected STAR.

2 Arrival Transitions (TRANS)

Displays all arrival transitions related to the selected STAR.

3 Selected Status Label (<SEL>)

Identifies arrival/approach procedures or a runway which has been selected for entry into the route, but not executed.

All <SEL> entries propagate to the MOD RTE and MOD RTE LEGS pages for subsequent execution.

4 Approach and Runway (APPROACHES, RUNWAYS)

Displays all approaches related to the selected STAR, followed by all related runways (unless the desired approach/runway was selected on the initial display).

5 Arrival Transition (TRANS)

Displays the selected arrival transition.

6 APPROACHES

Displays selected approach/runway.

7 Approach Transition (TRANS)

Displays all approach transitions related to the selected approach.

8 Active Status Labels (<ACT>)

Following execution of the selected entries, the arrival/approach procedures and runway are identified as active.

Note: For an existing active route, the execute key illuminates upon STAR or approach/runway selection. Following selections, the ERASE prompt is available. Selections should be executed on the RTE or RTE LEGS pages after linking any route discontinuities.

737 Flight Crew Operations Manual

Arrivals Page – Runway Extension Fix

YA371 - YC206, YE321 - YE326

INITIAL DISPLAY

KATL ARRIVALS		2 / 2
STARS	APPROACHES	
LGC2	ILS 27L	
MACEY1	ILS 27R	
RMG8	RUNWAYS	08L
SINCA		08R
PROF DES		
CANUK		09L
<INDEX	ROUTE>	

DISPLAY AFTER RUNWAY 08L SELECTED

KATL ARRIVALS		1 / 2
STARS	RUNWAYS	
LGC2	<SEL> 08L	
MACEY1	ILS 27R	
RMG8	RWY EXT	--.-NM

1

DISPLAY AFTER RUNWAY 08L EXTENSION INSERTED

RMG8	RWY EXT	16.0NM
------	---------	--------

DISPLAY AFTER EXECUTION

KATL ARRIVALS		1 / 2
STARS	RUNWAYS	
LGC2	<ACT> 08L	
MACEY1	ILS 27R	
RMG8	RWY EXT	16.0NM

1 Runway Extension (RWY EXT)

Permits entry of runway extension waypoint following selection of desired runway.

Desired extension distance is entered in scratch pad, then inserted on RWY EXT line. This creates a waypoint on the extended runway centerline at the specified distance from the threshold.

Waypoint is identified on the RTE and RTE LEGS pages as RX-YYY, where YYY is the runway designation.

737 Flight Crew Operations Manual

Arrivals Page – Runway Extension Fix and Flight Path Angle
YC207

INITIAL DISPLAY



DISPLAY AFTER RUNWAY 09 SELECTED



DISPLAY AFTER RUNWAY 09 EXTENSION FIX AND FPA INSERTED AND EXECUTED



1 Runway Extension (RWY EXT)

Permits optional entry of a runway extension waypoint following selection of desired runway.

Desired extension distance is entered in scratch pad, then inserted on RWY EXT line. Valid entries are between 1 and 25 NM (.1 NM resolution). This creates a waypoint on the extended runway centerline at the specified distance from the runway threshold.

Waypoint is identified on the RTE and RTE LEGS pages as RX-YYY, where YYY is the runway designation.

A speed/altitude constraint may be entered for the RWY EXT fix from the RTE LEGS page.

2 Flight Path Angle (FPA)

Permits optional entry of a flight path angle between the runway threshold and the runway extension fix. Default is 3.0 degrees. Valid entries are from 2.00 to 6.05 degrees.

Note: Dashes (---) are displayed on the DEP/ARR page when the default is used.

Approach Reference Page

The approach reference page displays approach planning information and approach reference speed (VREF) selection. The displayed data is for the DEST airport and the arrival/ approach entered into the FMC flight plan.

737 Flight Crew Operations Manual

YA371 - YA374, YC201 - YC206, YE321 - YE326

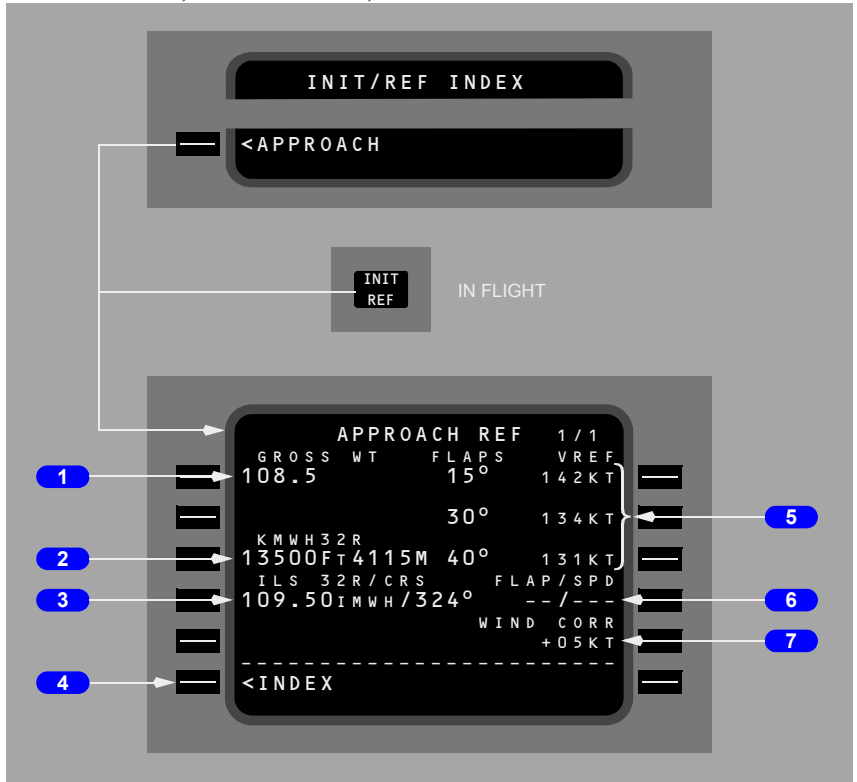

YA375 - YA377, YC207

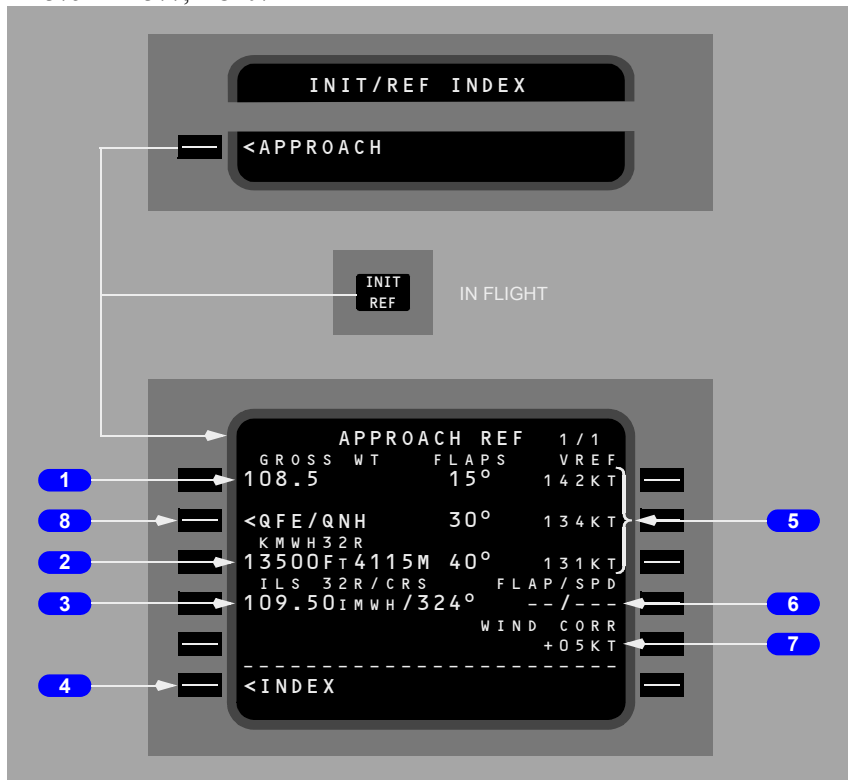

1 Airplane Gross Weight (GROSS WT)

Normally displays the FMC calculated airplane gross weight.

A manual entry of gross weight is allowed.

Displays box prompts when gross weight is not available from the FMC.

Valid entry is XXX.X.

Leaving and returning to this page replaces a manually entered weight with FMC computed gross weight.

2 Runway Length

Displays the length in feet and meters of the referenced runway.

Blank if no runway has been entered and executed.

3 Approach Information

Displays the runway number and associated ILS frequency/identifier for the ILS, LOC, or back course approach in the active flight plan.

Displays front course, if an ILS, localizer, or localizer backcourse is displayed on 4L. If the course is true displays is suffixed with “T”.

Blank if no approach has been executed.

4 INDEX

Push – selects the INIT/REF INDEX page.

5 Vref (FLAPS --- VREF)

Displays landing Vref for three flap settings as computed by the FMC. Displayed in small size characters.

Selection causes the flap and VREF speed to be placed in 4R.

Double line selection of a displayed Vref, or manual entry of another value, causes the flap and VREF speed to be placed in 4R and causes Vref to be displayed on the airspeed display. CDU display changes to large size characters.

Speeds are based on displayed gross weights.

Double line selection provides Vref to be used by VNAV in combination with wind correction.

Vref, once selected, will not be updated. To obtain an updated speed, the current speed must be deleted or a different Vref selected or entered.

6 Flap/Speed (FLAP/SPD)

Displays selected approach reference flap and speed setting.

Manual input of desired flap and/or speed settings may be made.

Valid entry format is FF/SSS, SSS, /SSS, FF/ or F/, where F or FF is a flap setting of 0, 1, 2, 5, 10, 15, 25, 30, 40 and SSS is a speed within the range displayed in 1R to 3R.

Entries may be deleted and are blanked at flight completion..

7 Wind Correction (WIND CORR)

Displays current wind correction for approach. Default is +05 knots.

Manual input of desired wind correction may be made up to +20 knots.

8 Landing Reference (LANDING REF)

YA375 - YA377, YC207

Push – Toggles altimeter reference between QFE and QNH.

Default is QNH.

Resets to QNH at flight complete.

Reflects TAKEOFF REF selection on TAKEOFF REF page 2.

Active altimeter reference is highlighted.

During descent with QFE selected, the PFD altitude indications show zero feet at the arrival runway. The PFD altitude indication background colors change to green.

If QFE is the current altimeter reference, and the EFIS control panel STD switch is pushed, The takeoff reference automatically toggles to QNH.

Holding

The FMC computes holding patterns with constant radius turns based on current winds and FMC commanded airspeed. The pattern size is limited to FAA or ICAO protected airspace. In LNAV, the AFDS tracks the holding pattern using up to a 30 degree bank angle. Strong winds or airspeed in excess of FAA or ICAO entry speeds may result in the airplane flying outside the protected airspace.

With LNAV active before sequencing the holding fix, holding pattern entries are determined by the following:

- the angle between the flight plan leg into the holding fix and the holding inbound course determines the entry method used (parallel, teardrop or direct entry)
- the airplane flies the initial outbound leg for a specified time (1.0 minute at or below 14,000 feet and 1.5 minutes above 14,000 feet)
- teardrop entries use an FMC calculated offset angle designed to intercept the outbound leg at the point where the inbound turn begins
- parallel and teardrop entries may cause the airplane to fly beyond the displayed holding pattern; however, the airplane remains in protected FAA or ICAO limits.

HOLD Page

The hold page is used to enter a holding pattern into the route.

When the flight plan does not have a holding pattern, push the HOLD function key to show the LEGS page with the HOLD AT line.

Two versions of the hold page are possible:

- an airway or procedure holding pattern (from the navigation database)
- a flight crew–entered holding pattern.



737 Flight Crew Operations Manual

The holding page shows actual or default data about the holding pattern.

Entries make route modifications, which can be erased or executed.

Active holding patterns are magenta on the navigation display.

Note: During FMC guided entrance to a hold, portions of the LNAV magenta holding pattern on the navigation display may not show. This may only occur when the holding pattern is within 5000 feet of the FMC computed MAX ALT, and after the UNABLE HOLD AIRSPACE scratchpad message shows. LNAV hold entry guidance will function normally.

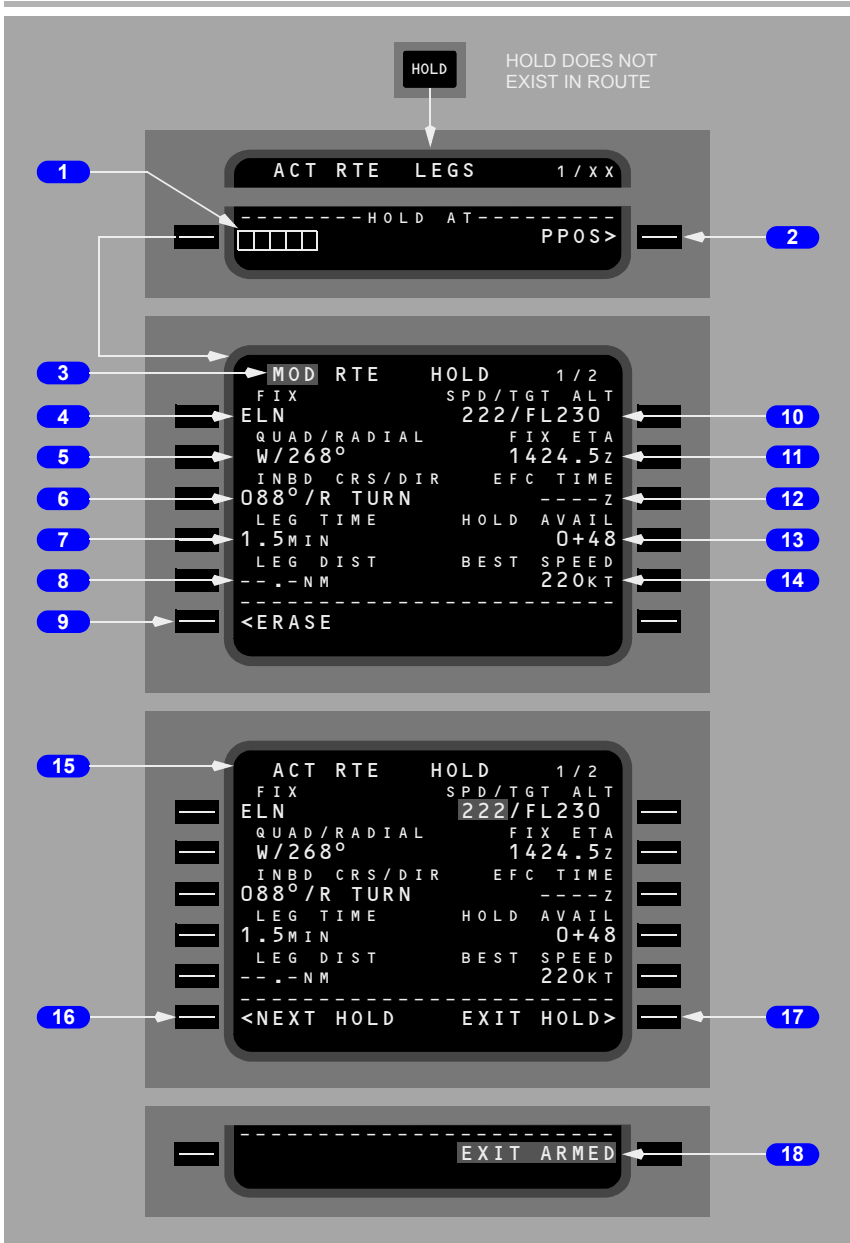

1 HOLD AT

When the HOLD function key is pushed and no holding pattern exists in the route, the LEGS page shows prompts to enter the holding fix. Enter the holding fix to show the RTE HOLD page.

Displays a prompt to enter the holding fix, a route waypoint, or present position. A waypoint is entered as the holding fix.

2 HOLD AT Present Position (PPOS)

Selects the airplane present position as the holding fix.

Only displayed during flight when not in a holding pattern.

3 Modified Route Hold Status

MOD indicates that the holding fix has not been executed.

Execution changes the page title to RTE HOLD (ACT RTE HOLD if holding at PPOS).

4 FIX

Displays waypoint identifier of the holding fix.

Entry is propagated either automatically from the database, or from a manual entry on the HOLD AT page.

If PPOS was selected on the HOLD AT page, then the FMC assigns PPOS as the fix identifier.

5 Quadrant/Radial (QUAD/RADIAL)

Displays holding pattern quadrant and radial.

Entry is propagated either automatically from the database, or from a manual entry on the HOLD AT page.

The default holding pattern inbound course and turn direction are in small font. Crew entered or holding patterns extracted from the database are in large font.

Valid entry is XXX (radial) or XX/XXX (quadrant/radial). Valid quadrant entry is N, NE, E, SE, S, SW, W, NW.

Quadrant shall be determined by the resulting inbound course.

6 Inbound Course/Direction (INBD CRS/DIR)

Displays holding inbound course and turn direction.

Entry is propagated either automatically from the database, or from a manual entry on the HOLD AT page.

The default holding pattern inbound course and turn direction are in small font. Crew entered or holding patterns extracted from the database are in large font.

Valid entry is XXX (inbound course), XXX/X (inbound course/turn direction), /X or X (turn direction).

Automatically changes QUAD/RADIAL to agree.

For a flight crew–entered holding pattern, the inbound course is initially the same as the preceding leg to the fix.

For a flight crew–entered holding pattern, if no entry is made, the FMC assumes right turns.

Magenta when the holding fix is the active waypoint.

7 LEG TIME

Displays holding pattern leg time.

Valid entry is XXX.X. Manual entry has priority.

If no entry is made, the FMC assumes the standard times of 1.0 minute at or below 14,000 feet and 1.5 minutes above 14,000 feet.

The default leg times are displayed in small font. Crew entered or holding patterns extracted from the database are displayed in large font.

The holding pattern will automatically be resized when climbing or descending through 14,000 feet if the holding pattern size is not defined in the database or has not been manually entered.

If a LEG DIST is manually entered, then dashes will be displayed.

8 Leg Distance (LEG DIST)

Dash prompts are normally displayed.

Entry may be propagated either automatically from the database, or made by manual entry.

Manual entry has priority.

Overrides LEG TIME.

9 ERASE

Displayed only while modification is in progress.

Push – deletes modification and returns to ACT RTE HOLD page, if one exists; otherwise returns to the ACT RTE LEGS page.

10 Speed/Target Altitude (SPD/TGT ALT)

Displays current speed and altitude (small font).

737 Flight Crew Operations Manual

Speed or altitude constraint may be entered. Manual entries are in large font and propagate to LEGS page.

Note: When a cruise hold exists, cruise speed changes propagate around the hold but have no effect on holding speed.

11 Fix Estimated Time of Arrival (FIX ETA)

Displays computed time for next passage over holding fix.

12 Expect Further Clearance Time (EFC TIME)

Entry of the EFC time will help optimize FMC performance computations.

Computation of destination fuel assumes that departure from the holding fix will occur at this time.

13 Hold Available (HOLD AVAIL)

Displays available holding time in hours + minutes remaining if destination is to be reached with planned fuel reserves as entered on PERF INIT page.

14 BEST SPEED

Displays computed best holding speed based on present altitude and conditions.

Note: May exceed maximum speed permitted by regulatory agency.

15 Active Route Hold Status

ACT indicates that the airplane has entered the holding pattern.

16 NEXT HOLD

Displayed when the route contains less than five holding patterns and there is no route modification in progress.

Push – displays (RTE LEGS) HOLD AT page and prompts for new holding fix entry.

17 EXIT HOLD

Displayed on the holding page when in the holding pattern.

Used when preparing to depart holding pattern.

Push – changes prompt to EXIT ARMED and illuminates execute key.

18 EXIT ARMED

Displayed on the holding page when in the holding pattern and after line selection of EXIT HOLD prompt.

Execution activates LNAV flight back to the holding fix via a shortened holding pattern, departure from holding pattern, and continued flight along the active route. ACT RTE LEGS page 1/XX appears after holding exited.

Highlighted in reverse video after execution.

2 HOLD AT

Used to enter any waypoint identifier, which then defines a holding fix.

Entry may be via keyboard, or by transfer of any downpath waypoint which is in the existing route (the example depicts ELN line selected into the scratch pad).

Following line selection of the desired waypoint into the box prompts, the MOD RTE HOLD page appears and the execute key illuminates.

3 Present Position (PPOS)

Push – selects holding fix at present position. The MOD RTE HOLD page appears and the execute key illuminates (“present” is at the time of execution of the MOD RTE HOLD page).

Displayed only in flight.

Default parameters are a standard holding pattern on the inbound leg.

4 Hold at Waypoints (HOLD AT)

A holding fix creates a new HOLD AT waypoint following the leg to that waypoint.

Displayed on the RTE LEGS page in the proper route sequence after executing the related MOD RTE HOLD page.

RTE LEGS HOLD AT (Fix not in Route)

HOLD DISPLAY AFTER OFF-ROUTE WAYPOINT SELECTED

	ACT	RTE	LEGS	1 / X X
—	087°		11 NM	
—	BANDR		310 / FL190	
—	089°		26 NM	
—	BEEZR		320 / FL190	
—	089°		19 NM	
—	ELN		320 / FL190	
—	069°		42 NM	
—	D182X		240 / 6279	
—	092°		4 NM	
—	D160X		240 / 5352	
—	- RNP / ACTUAL - - - - -			
—	12.0 / 0.21 NM		RTE DATA >	
1	HOLD AT PLUS			

AFTER LINE SELECTING THE DESIRED LEGS PAGE SEQUENCE AND EXECUTING THE OFF ROUTE HOLD

	ACT	RTE	LEGS	1 / X X
—	067°		96 NM	
2	PLUS		310 / FL190	
—	HOLD AT			
3	PLUS		220 / FL190	
—	THEN			
—	- - ROUTE DISCONTINUITY -			
—	BANDR		320 / FL190	
—	089°		26 NM	
—	BEEZR		320 / FL190	
—	- RNP / ACTUAL - - - - -			
—	12.0 / 0.21 NM		RTE DATA >	

1 Hold at Waypoint (HOLD AT XXXX)

Displayed in the scratch pad whenever the entry in the HOLD AT line is not a waypoint in the existing route (the example above depicts entry of PLUS).

Route position of the holding fix is defined by line selecting to the desired LEGS page sequence.

Following line selection to the desired LEGS page sequence, the MOD RTE HOLD page appears and the execute key illuminates.

2 Hold at Waypoints (HOLD AT)

A holding fix creates a new HOLD AT waypoint following the leg to that waypoint.

Displayed on the RTE LEGS page in the proper route sequence after executing the related MOD RTE HOLD page.

3 ROUTE DISCONTINUITY

The entered route must always form a continuous path of linked legs.

The example depicts a HOLD AT entry where the entry was not a downpath waypoint.

The FMC computes a direct course to the off-route holding fix.

The HOLD AT waypoint becomes a termination identifier which is not part of the existing route. The resulting route discontinuity is identified by box prompts, requiring entries to define the route after PLUSS.



Introduction

FMC messages tell the flight crew when system operation is degraded or if there are data input errors.

FMC messages show in the CDU scratchpad. The messages are categorized as:

- alerting messages
- entry error messages
- advisory messages.
- FMC data link messages (alerting and advisory)

The FMC messages are shown according to their level of importance. Alerting messages are most important, followed by entry error messages. Advisory messages are least important. If multiple messages exist, a less important message replaces another message in the scratchpad when the CLR key is pushed or the condition is corrected.

The amber FMC alert light on each pilot's instrument panel illuminates when there is an FMC alerting message. All FMC messages illuminate the CDU message (MSG) light. Clear the message or correct the condition to cancel the message.

The following tables are general lists; some messages may not apply to all FMC configurations.

FMC Alerting Messages

These messages relate to operationally significant conditions which affect FMC operation.

FMC alerting messages:

- are shown in the CDU scratchpad
- cause the amber FMC alert light on each pilot's instrument panel to illuminate
- illuminate message lights (MSG) on both CDUs.

Use the CLR key or correct the condition responsible for the message to remove the message. The message is temporarily removed from the scratchpad when manually entering data. The message returns when the data is removed from the scratchpad.

ALERTING MESSAGE	CAUSE	CORRECTIVE ACTION
CRZ ALT CHANGED TO XXXXXX	U10.4 and later: During a missed approach a STAR or approach has been selected that conflicts with the cruise altitude.	Clear the message.
CHECK ALT TGT	U10.5 and later: VNAV disengages while airplane is between MCP and FMC altitudes or VNAV button pressed while airplane is between MCP and FMC altitudes.	Clear the message.
CUTBACK DISARMED	U10.6 and later: Cutback turned off as a result of changing or deleting the flight plan runway while on the ground.	Clear the message. Re-arm as required.
CUTBACK UNAVAILABLE	U10.3 and later: The FMC is unable to compute a Cutback N1 value.	Clear the message.
CYCLE IRS OFF-NAV	IRS is unable to complete alignment under current conditions.	Cycle IRS mode selector to "OFF" and back to "NAV."

737 Flight Crew Operations Manual

ALERTING MESSAGE	CAUSE	CORRECTIVE ACTION
DATA BASE INVALID	The automatic validity test of the permanent navigation database has failed.	Advise maintenance personnel to check the FMC and reload the database, as required. If desired, consider the use of the temporary nav database.
DISCO INSRTRD AFTR XXXXX (waypoint identifier)	A ROUTE DISCONTINUITY has been inserted into the flight plan due to undefined termination of a downpath leg or a double waypoint BYPASS.	Select the RTE or RTE LEGS pages and modify the waypoints for a continuous route.
DISCONTINUITY	Passing the last waypoint in the route prior to a ROUTE DISCONTINUITY (LNAV disengages) or pressing LNAV while in a discontinuity.	Select the RTE LEGS page. Enter the desired active waypoint into the box prompts. Correct any ROUTE DISCONTINUITY and EXECute. Reengage LNAV.
DUAL FMC OP RESTORED	Dual FMC operation has been successfully restored. (Dual FMC as installed)	Clear message and set FMC source select switch to NORMAL.
END OF OFFSET	Two minutes prior to passing offset leg termination.	Confirm clearance.
END OF ROUTE	LNAV engaged and passing the last waypoint in the route (LNAV disengages).	Select the RTE LEGS page. Enter the desired active waypoint into the dash prompts and EXECute. Reengage LNAV.
ENG OUT SID MOD	U10.3 and later: An engine-out SID has been automatically inserted into the flight plan as a modification.	Clear the message.



737 Flight Crew Operations Manual

ALERTING MESSAGE	CAUSE	CORRECTIVE ACTION
ENTER IRS POSITION	IRS in the alignment mode needs present position to complete alignment. Previous present position entry was not received back from the IRS.	Enter IRS present position into the scratchpad pad and line select 4R on the POS INIT page of the CDU. If present position was previously entered, overwrite displayed data. If necessary, enter present position directly into the IRS control /display unit.
FMC APP/TUNE DISAGREE	U10.5 and later: An approach that utilizes FMC generated glidepath is in the active flight plan but an approach navaid (ILS/GLS) has been tuned with G/S ON.	Confirm the tuned frequency and approach selected in the FMC are both consistent with the actual approach intended to be flown. Resolve tuning or approach selection inconsistency. Clear the message.
FMC APP MODE UNAVAIL-QFE	U10.5 and later: An approach that utilizes FMC generated glidepath is in the flight plan (active or inactive) but QFE is selected on the FMC.	Select QNH as the landing altimeter reference on the APPROACH REF page. Clear the message.
FMC DISAGREE	U10.6 and later: During approach or on the ground, monitored parameters required for dual FMC operation are in disagreement. (Dual FMC as installed)	Monitor FMCs closely. Both FMCs remain online. Limit approaches to single FMC only. If desired, revert to SINGLE FMC OPERATION in this section.
INSUFFICIENT FUEL	A change in conditions or flight plan route causes predicted fuel at destination to be 900 kilograms/2000 lbs or less.	Modify the route plan or cruising altitude, or divert for additional fuel.
IRS MOTION	IRS has automatically restarted the alignment due to detection of excessive motion.	Clear message and attempt to reduce airplane movement, if practicable.

737 Flight Crew Operations Manual

ALERTING MESSAGE	CAUSE	CORRECTIVE ACTION
IRS NAV ONLY	U10.2A and earlier: Navigation accuracy is not sufficient for present phase of flight.	Refer to FMC Navigation Check Supplementary Procedure.
LNAV BANK ANGLE LIMITED	U10.2 thru U10.5A: Airplane is within 5 minutes or less from an LNAV guided course change that will exceed airway/route boundaries due to LNAV performance limited bank angle. U10.6 and later: LNAV is engaged and the airplane is not on a lateral offset and is not near or in an orbit or hold and the airplane is within 5 minutes or less from an LNAV guided course change, and will exceed the airway/route boundaries for non-flyover turns less than or equal to 135 degrees due to performance limited bank angle. This message does not apply to fixed radius turns.	Review the LNAV course change. If course change exceeds airway/route boundary, consider flight plan change.
MAX ALT FLXXX (flight level value)	Altitude intervention (as installed) attempt to raise cruise altitude when MCP altitude is above maximum altitude.	Clear the message.
MISSED CAPTURE	Proper localizer capture maneuver was performed, but the AFDS did not capture.	Clear the message.
MODEL/ENG DATA INVALID	A valid performance database is not available.	Contact maintenance personnel.



737 Flight Crew Operations Manual

ALERTING MESSAGE	CAUSE	CORRECTIVE ACTION
NAV DATA OUT OF DATE	Effectivity dates of nav database do not agree with date input from clock.	Check the IDENT page and reverse the dates for ACTIVE NAV DATA if required.
NAV INVALID-TUNE XXXXX (navaid identifier)	FMC is unable to auto-tune or receive the navaid for a RNAV or VOR approach procedure.	Cross-check radios and manually tune the desired navaid.
OVERSPEED DISCONNECT	U10.1 and earlier: During path descent and below the speed restriction altitude, VNAV disengages when airspeed exceeds FMC speed restriction by more than 15 knots. U10.2 and later: During path descent and above or below the speed restriction altitude, VNAV disengages when airspeed exceeds FMC speed restriction by more than 15 knots.	Manually reduce speed and reengage VNAV.
PARTIAL ROUTE LOADED	U10.3 and later: A route is loaded which references data not contained in the database.	Clear the message.
PERF DEFAULTS INVALID	Validity check of performance defaults database has failed.	Contact maintenance personnel.

737 Flight Crew Operations Manual

ALERTING MESSAGE	CAUSE	CORRECTIVE ACTION
RESET MCP ALT	U10.5 and earlier: During the FMC cruise phase, when within 5 NM of the top-of-descent point without selecting a lower altitude on the AFDS MCP. U10.5A and later: During the FMC cruise phase with VNAV engaged, when within 5 NM of the top-of-descent point without selecting a lower altitude on the AFDS MCP.	Select lower MCP altitude values as clearances permit.
RTA UNACHIEVABLE	The RTA is not in the computed RTA window under current parameters.	Enter an achievable RTA or discontinue the RTA mode of navigation. Adjust parameters to meet the RTA.
RW/APP TUNE DISAGREE	U10.4 and later: During approach, manual tuned approach frequency or channel does not match active flight plan.	Clear the message and select correct approach frequency.
RW/APP CRS ERROR	U10.4 and later: During approach, MCP selected course does not match front course for the approach in the active flight plan.	Clear the message and select correct MCP course.
SCANNING DME FAIL	Inputs from both frequency scanning DME radios have failed.	Clear the message and check position. Radio updating of FMC position is not available.
SELECT MODE AFTER RTA	RTA mode has been discontinued due to sequencing of RTA waypoint or RTA waypoint has been removed from the flight plan.	Select desired navigation mode. (ECON, manual speed, etc.)



737 Flight Crew Operations Manual

ALERTING MESSAGE	CAUSE	CORRECTIVE ACTION
SINGLE FMC OPERATION	The primary FMC has determined that the secondary FMC is not available. (Dual FMC as installed)	If the FMC source selector switch is in the “Normal” position, move to “BOTH ON L”. No action is required if the FMC source selector switch is already positioned to “BOTH ON L” or “BOTH ON R”.
TAKEOFF SPEEDS DELETED	U10.0: Runway or runway data is changed after the V speeds have been entered. U10.1 thru U10.5A: A change to runway, runway data, takeoff thrust selection or performance data is made after the V speeds have been selected. U10.6 and later: A change to runway, runway data, takeoff thrust selection or performance data is made after the V speeds have been selected, or entered V speeds fail to meet relative value check.	Reselect new V speeds and clear message.
THRUST REQUIRED	U10.5 and later: Airplane is in an underspeed condition.	Clear the message. Increase airspeed to within 15 knots of speed target.
UNABLE HOLD AIRSPACE	U10.2 and later: LNAV guided holding pattern may exceed allowable hold airspace due to LNAV performance limited bank angle.	Review the holding pattern. If holding pattern exceeds allowable holding airspace, consider flight plan change.

737 Flight Crew Operations Manual

ALERTING MESSAGE	CAUSE	CORRECTIVE ACTION
UNABLE NEXT ALTITUDE	<p>Unable to meet the next flight plan altitude constraint in a VNAV SPD climb or descent. The message appears only with VNAV engaged.</p> <p>U10.4 and later: Unable to meet the next flight plan altitude constraint in a VNAV climb or descent. The message appears only with VNAV engaged.</p>	<p>Clear the message and review the prediction. For undershoot condition during climb, consider selection of MAX RATE CLB or MAX ANGLE CLB, or a different N1 limit as appropriate.</p>
UNABLE PROC AIRSPACE	<p>U10.6 and later: Minimum procedure turn built by guidance exceeds the allowable excursion distance.</p>	<p>Modify flight plan as required.</p> <p>Clear the message.</p>
UNABLE REQD NAV PERF-RNP	<p>U10.2A and earlier: FMC actual navigation performance is not sufficient for the current special RNP (crew entered or leg specified).</p> <p>U10.3 and later: FMC actual navigation performance is not sufficient for the displayed RNP.</p>	<p>During approach: Refer to UNABLE REQD NAV PERF - RNP non-normal checklist in the QRH.</p> <p>During other phases of flight: Refer to the FMC Navigation Check supplementary procedure in SP.11.</p>
VERIFY GW AND FUEL	<p>Fuel data becomes invalid, PERF INIT fuel value is replaced with dashes. FMC uses last valid fuel quantity for performance predictions until manual entry is made.</p> <p>Shows if 30 minutes have elapsed since last manual entry.</p> <p>Does not show in descent with Vref selected.</p>	<p>Enter fuel weight on PERF INIT page 1/2. Periodic update of fuel weight is required to keep gross weight value current.</p>



737 Flight Crew Operations Manual

ALERTING MESSAGE	CAUSE	CORRECTIVE ACTION
VERIFY POSITION	Position information is contradictory.	Refer to FMC Navigation Check Supplementary Procedure.
VERIFY RNP	U10.2A and earlier: Underlying RNP value is less than manually entered value or a GPS approach has been selected and the default RNP is active (no crew entered or leg specified RNP active). U10.3 and later: Underlying RNP value is less than manually entered value.	Enter appropriate RNP.
VERIFY TAKEOFF SPEEDS	A PERF INIT change has been made after takeoff speeds were specified.	On TAKEOFF REF page 1, accept previous V speeds, or reject previous V speeds and enter new V speeds.
VERIFY VERT RNP	U10.5 and later: During an active descent with CDS navigation performance scales enabled, a manually entered vertical RNP is greater than the default vertical RNP.	Clear CDU message. Enter appropriate vertical RNP.
VNAV DISCONNECT	The criteria for VNAV engagement is not satisfied (VNAV disengages). U10.4 and later: On approach, with VNAV engaged, the FCC has switched to LVL CHG.	Manually control the vertical path.

FMC Entry Error Messages

These messages relate to incorrect scratchpad entries. FMC entry error messages:

- are shown in the CDU scratchpad
- illuminate the message light (MSG) of the CDU where the entry error was made
- temporarily overwrite data in the scratchpad.

Use the CLR key or key in new data to remove the message. If the CLR key is used to remove the message, the data previously entered is once again displayed. If new data is keyed in over the message, the message and the data previously entered are removed.

ENTRY ERROR MESSAGE	CAUSE	CORRECTIVE ACTION
ALT CONSTRAINT XXXXX (waypoint identifier)	A flight plan modification has caused an altitude conflict with a waypoint that has an altitude constraint.	Clear the message and revise the entry.
DATA BASE FULL	Entry attempted into a supplemental or temporary navigation database category which is full.	Go to the NAV DATA pages and delete unneeded waypoints, navaids, or airports from the appropriate database and re-attempt entry.
DUPLICATE FLIGHT PLAN ID	U10.3 and later: The entry attempted is a duplicate of an existing supplemental flight plan name.	Clear the message and select a unique flight plan name.
INVALID DELETE	DEL key operation was attempted for a data line to which it was not applicable.	Clear the message and select the proper line after the DEL key is pressed.
INVALID ENTRY	Attempted data entry has incorrect format, range, etc. for the selected data line. Entered RTA waypoint is not in the flight plan.	Clear the message and scratchpad entry, and repeat the entry with the correct data.
INVALID QUAD	U10.2 and later: Attempted HOLD page QUAD entry has incorrect format or range.	Clear the message and revise the QUAD entry.

737 Flight Crew Operations Manual

ENTRY ERROR MESSAGE	CAUSE	CORRECTIVE ACTION
NO OFFSET AT LEG XXXXXX (waypoint)	Attempted entry of a lateral offset start or end waypoint XXXXXX that is not offsetable (lateral offset as installed).	Clear the message and amend the route.
NOT IN DATA BASE	FMC does not contain the required data for the entered identifier.	Clear the message and check data entry, or enter the required information into the supplemental or temporary navigation database via the NAV DATA pages.
NOT IN FLIGHT PLAN	RTA waypoint or lateral offset (as installed) start/end waypoint entry is not in active flight plan.	Clear the message and amend the entry.
ROUTE FULL	Entry of more than maximum allowed number of waypoints or holding patterns attempted.	Clear the message and review existing and desired waypoints and holding patterns for possible deletion.
SUPP RTE DATA BASE FULL	U10.3 and later: Attempted save of the 11th supplemental flight plan.	Clear the message, delete unneeded supplemental flight plans and re-attempt entry.

737 Flight Crew Operations Manual

FMC Advisory Messages

These messages relate to FMC status. FMC advisory messages:

- are shown in the CDU scratchpad
- illuminate message lights (MSG) on both CDUs.

Use the CLR key or correct the condition responsible for the message to remove the message. The message is temporarily removed from the scratchpad when manually entering data. The message returns when the data is removed from the scratchpad.

ADVISORY MESSAGE	CAUSE	CORRECTIVE ACTION
ABOVE MAX CERT ALT	The airplane is above its maximum certified altitude.	Descend to an altitude below the maximum certified altitude.
APPRCH VREF NOT SELECTED	Airplane has transitioned into approach environment and Vref has not been selected on APPROACH REF page.	Select Vref on APPROACH REF page.
ARR N/A FOR RUNWAY	Runway or approach does not match the selected arrival procedure.	Go to the ARRIVALS page and modify selection.
BUFFET ALERT	Current conditions result in a maneuver margin less than specified.	Bring the airplane back within the operating envelope.
CHECK FMC FUEL QUANTITY	The FMC has detected an unexpected drop in the fuel quantity.	Check the fuel quantity indications for correctness.
DES PATH UNACHIEVABLE	When in path descent and above the path, the FMC predictions show the profile restrictions at the next waypoint cannot be achieved (LNAV remains engaged).	Modify the restrictions.
DRAG REQUIRED	Airspeed is 10 kts or more above FMC target speed or within 5 kts of V _{mo} /V _{mmo} .	Use speedbrakes, trim or reduced thrust, as required, to bring the airplane within 5 kts of FMC target speed.

737 Flight Crew Operations Manual

ADVISORY MESSAGE	CAUSE	CORRECTIVE ACTION
FMC APP MODE UNAVAIL–GP	U10.5 and later: The approach selected in the FMC does not have a specified glidepath angle for final approach. The FMC approach mode cannot be used for this approach.	Select an alternate approach. Clear the message.
INVALID OFFSET	Desired offset does not meet FMC offset criteria.	Clear the message and amend the entry.
KEY/FUNCTION INOP	A mode key is pressed for which an FMC function has not been implemented or has not been enabled. (FANS MCDU only)	Clear the message or select another CDU page for display.
LOC CAP ACTIVE	The airplane is approaching its turn onto the localizer or GLS course and will maintain an intercept heading.	Clear the message manually, or wait for the AFDS to signal reset status to the FMC.
LOC CAP CANCELLED	Flight plan modifications or the airplane condition did not facilitate localizer capture.	Clear the message manually, or wait for the AFDS to reset to LOC CAP ACTIVE.
MAX ALT FLXXX (flight level value)	Altitude entry on any page is above the maximum altitude for current selected performance margins.	Clear the message or amend the data entry.
MAX MACH .XXX/MIN MACH .XXX OR MAX CAS .XXX/MIN CAS .XXX	FMC target speed is greater than the maximum or less than the minimum buffet speed for the entered cruise or step climb altitude.	Change the target speed to within the message limits or enter a lower altitude.
MCP APP DISARM REQD	U10.4 and U10.4A: A change in the expected vertical approach control from glideslope (G/S) to FMC generated glidepath (G/P) is required.	Clear the message. Change the active flight plan approach to one that utilizes FMC generated glidepath. Check that G/S is turned off. Re-arm approach mode if required.



737 Flight Crew Operations Manual

ADVISORY MESSAGE	CAUSE	CORRECTIVE ACTION
NO DES PATH AFTER XXXXX (waypoint)	FMC is unable to construct a PATH DES that satisfies all altitude restrictions after XXXXX.	Modify speed or altitude restrictions on the RTE LEGS pages.
NOT ON INTERCEPT HEADING	Airplane is not within the LNAV capture criteria for the active leg (LNAV disengages).	Manually place the airplane on an intercept heading and reengage LNAV.
OFFSET DELETED	The entered start waypoint has been deleted from the flight plan. (lateral offset as installed)	Clear the message and amend the route.
OFST ENDS ABEAM XXXXXX	An invalid offset leg exists between the end waypoint (XXXXXX) and the start of offset or no end waypoint exists.	Clear the message and amend the route.
PERF DEFAULTS DELETED	Performance database has been automatically deleted due to conflict with performance database limits.	Contact maintenance personnel.
POS SHIFT OVER 50NM	U10.6 and later: A viable position shift is currently selected that will result in an FMC position shift in excess of 50nm when executed.	Clear the message.
PROGRAM PIN ERROR	FMC connector wiring is incorrect.	System unusable; advise maintenance personnel. The CLR key will not clear the message.
PROGRAM PIN NOT IN DB	FMC connector wiring or performance database is incorrect.	Contact maintenance personnel.
RESET MCP ALT	Normal FMC operation would require flying away from MCP altitude.	Select a MCP altitude value in the proper direction (higher for climb, lower for descent).



737 Flight Crew Operations Manual

ADVISORY MESSAGE	CAUSE	CORRECTIVE ACTION
RESET MCP APP MODE	U10.5 and later: A change in the expected approach is made with an FCC approach mode armed or engaged.	Clear and rearm FCC approach mode. Clear the message.
RUNWAY N/A FOR SID	The selected runway is not applicable to the selected departure procedure.	Clear the message and check selections on the DEPARTURES page. Modify as required.
SELECT ACTIVE WPT/LEG	Power-up restart or insertion of a different flight plan while airborne.	EXECute a direct-to or leg intercept to tell the FMC which leg of the route is active.
STEEP DESCENT AFTER XXXXXX	An excessive vertical discontinuity exists after point XXXXXX.	Check routing.
TAI ON ABOVE 10°C	Airplane is operating with anti-icing with TAT above +10°C.	Clear the message and check the use of anti-icing for engines and/or wings.
UNABLE CRZ ALT	FMC predicts that no cruise time is possible at the entered CRZ ALT.	Clear the message and review the CRZ ALT selection.
UNABLE MACH .XXX	The entered cruise Mach is unattainable based on present gross weight.	Select a smaller Mach number or wait until gross weight is reduced sufficiently.
UNABLE TO OFFSET	A valid offset cannot be constructed due to geometric limitations.	Clear the message and amend the route.
USING RSV FUEL	Predicted fuel remaining at DEST is less than the RESERVES entry on the PERF INIT page.	Clear the message and change routing if required.
V SPEEDS UNAVAILABLE	FMC cannot compute V speeds (as installed) due to unreasonable inputs on the RTE, PERF INIT, or TAKEOFF REF pages.	Correct inputs that affect V speed computation.



737 Flight Crew Operations Manual

ADVISORY MESSAGE	CAUSE	CORRECTIVE ACTION
VERIFY RNP VALUE	When entering an RNP the underlying RNP value is smaller than the manually entered value or the ANP is greater than the manually entered RNP.	Change or delete the manually entered RNP.
VERIFY VERT RNP VALUE	U10.5 and later: With CDS navigation performance scales enabled, a manually entered vertical RNP is greater than the default vertical RNP or manually entered vertical RNP is less than that vertical ANP.	Clear the message. Change or delete the manually entered RNP.
XXXX (airport identifier)	A REF AIRPORT is entered on the POS INIT page and no entry of ORIGIN yet appears on RTE page 1.	Enter the airport identifier on the ORIGIN data line.
XXXXX (MCP altitude value)	With the CRZ page displayed, resetting the AFDS MCP altitude to a value different from the CRZ ALT causes the value to appear in the scratchpad.	Enter the MCP altitude value on the appropriate target altitude data line.

FMC Data Link Messages

These messages relate to FMC data link message status. FMC data link alerting and advisory messages function the same as the alerting and advisory messages described above:

FMC Data Link Alerting Messages

ALERTING MESSAGE	CAUSE	CORRECTIVE ACTION
ALTN DEST UPLINK	An FMC alternate destinations uplink message has been loaded on the ALTERNATE DESTS page, and is ready for flight crew review. (Alternate destinations as installed)	Review the alternate destinations uplink.
CRZ WIND UPLINK LOADING	An FMC cruise wind uplink message is loading (after LOAD selected on the RTE DATA page).	Wait for load to complete.
CRZ WIND UPLINK READY	An FMC cruise wind uplink message has been received and is available for loading on the RTE DATA page.	Select RTE DATA page, LOAD cruise wind, and execute or ERASE.
CRZ WIND XXXXX (cruise altitude) UPLINK	An FMC cruise wind uplink message has been loaded on the RTE DATA page, and is ready for flight crew review.	Review the cruise wind uplink, and execute or ERASE.
DATALINK CONFIG INVALID	Validity check of the FMC datalink configuration file has failed.	Contact maintenance personnel.
DESCENT FORECASTS UPLINK	An FMC descent forecasts uplink message has been loaded on the DESCENT FORECASTS page, and is ready for flight crew review.	Review the descent forecasts uplink, and execute or ERASE.

737 Flight Crew Operations Manual

ALERTING MESSAGE	CAUSE	CORRECTIVE ACTION
FORECASTS UPLINK READY	An FMC descent forecasts uplink message has been received and is available for loading on the DESCENT FORECASTS page.	Select DESCENT FORECASTS page, LOAD descent forecasts winds, and execute or ERASE.
INVALID TAKEOFF XXX/YYY (runway or runway/intersection identifier)	Runway (RTE page) or runway/intersection (TAKEOFF REF page) has been entered that matches runway takeoff data in FMC memory. However, the airplane is performance limited for the selected runway.	Clear the message. Enter correct takeoff data, request new takeoff data uplink, or enter new runway or runway/intersection identifier.
NAV DATA LOADING	An FMC supplemental navigation data uplink message has been received and is loading.	Wait for load to complete.
NAV DATA UPLINK	An FMC supplemental navigation data uplink message has been loaded on the SUPP NAV DATA page, and is ready for flight crew review.	Review the supplemental navigation data uplink, and execute or ERASE.
PARTIAL ALTN DEST UPLINK	An FMC alternate destinations uplink message has been loaded on the ALTERNATE DESTS page, but errors were encountered during the loading process. (Alternate destinations as installed)	Review the alternate destinations uplink, and execute or ERASE.
PARTIAL FORECASTS UPLINK	An FMC descent forecasts uplink message has been loaded on the DESCENT FORECASTS page, but errors were encountered during the loading process.	Review the descent forecasts uplink, and execute or ERASE.



737 Flight Crew Operations Manual

ALERTING MESSAGE	CAUSE	CORRECTIVE ACTION
PARTIAL LIMITS UPLINK	An FMC performance limits uplink message has been loaded on the PERF LIMITS page, but errors were encountered during the loading process.	Review the performance limits uplink, and execute or ERASE.
PARTIAL NAV DATA UPLINK	An FMC supplemental navigation data uplink message has been loaded on the SUPP NAV DATA page, but errors were encountered during the loading process.	Review the supplemental navigation data uplink, and execute or ERASE.
PARTIAL PERF INIT UPLINK	An FMC performance initialization uplink message has been loaded on the PERF INIT page, but errors were encountered during the loading process.	Review the performance initialization uplink, and execute or ERASE.
PARTIAL ROUTE UPLINK	An FMC route uplink message has been loaded on the RTE page, but errors were encountered during the loading process.	Review the route uplink, and execute or ERASE.
PERF INIT UPLINK	An FMC performance initialization uplink message has been loaded on the PERF INIT page, and is ready for flight crew review.	Review the performance initialization uplink, and execute or ERASE.
PERF INIT UPLINK READY	An FMC performance initialization uplink message has been received and is available for loading on the PERF INIT page.	Select PERF INIT page, LOAD performance initialization data, and execute or ERASE.
PERF LIMITS UPLINK	An FMC performance limits uplink message has been loaded on the PERF LIMITS page, and is ready for flight crew review.	Review the performance limits uplink, and execute or ERASE.



737 Flight Crew Operations Manual

ALERTING MESSAGE	CAUSE	CORRECTIVE ACTION
PERF LIMITS UPLINK READY	An FMC performance limits uplink message has been received and is available for loading on the PERF LIMITS page.	Select PERF LIMITS page, LOAD performance limits, and execute or ERASE.
RESEND MESSAGE	An FMC downlink message was attempted, but the FMC was unable to deliver the message to the ACARS MU.	Re-send the downlink message.
ROUTE DATA UPLINK	An FMC route uplink message has been loaded on the RTE page, and is ready for flight crew review.	Review the route uplink, and execute or ERASE.
ROUTE UPLINK LOADING	An FMC route uplink message is loading (after LOAD selected on the RTE page).	Wait for load to complete.
ROUTE UPLINK READY	An FMC route uplink message has been received and is available for loading on the RTE page.	Select RTE page, LOAD route, and execute or ERASE.
RTA DATA UPLINK	An FMC RTA uplink message has been loaded on the RTA PROGRESS page, and is ready for flight crew review.	Review the RTA uplink, and execute or ERASE.



737 Flight Crew Operations Manual

ALERTING MESSAGE	CAUSE	CORRECTIVE ACTION
RTA UPLINK READY	An FMC RTA uplink message is has been received and is available for loading on the RTA PROGRESS page.	Select RTA PROGRESS page, LOAD RTA data, and execute or ERASE.
TAKEOFF DATA LOADED	Uplink takeoff data matching Runway (RTE page) or runway/intersection (TAKEOFF REF page) has been loaded on the TAKEOFF REF page, and is ready for flight crew review.	Select TAKEOFF REF page, accept or reject takeoff data.
TAKEOFF DATA UPLINK	An FMC takeoff data uplink message containing one or more sets of runway takeoff data has been received and loaded in FMC memory.	Enter appropriate runway (RTE page) or runway/intersection (TAKEOFF REF page) to access runway takeoff data.



737 Flight Crew Operations Manual

FMC Data Link Advisory Messages

ADVISORY MESSAGE	CAUSE	CORRECTIVE ACTION
INVALID ALTN DEST UPLINK	An FMC alternate destinations uplink message was received, but was rejected due to errors.	Clear the message.
INVALID CRZ WIND UPLINK	An FMC cruise wind uplink message was received, but was rejected due to errors.	Clear the message.
INVALID FORECASTS UPLINK	An FMC descent forecasts uplink message was received, but was rejected due to errors.	Clear the message.
INVALID LIMITS UPLINK	An FMC performance limits uplink message was received, but was rejected due to errors.	Clear the message.
INVALID NAV DATA UPLINK	An FMC supplemental navigation data uplink message was received, but was rejected due to errors.	Clear the message.
INVALID PERF INIT UPLINK	An FMC performance initialization uplink message was received, but was rejected due to errors.	Clear the message.
INVALID ROUTE UPLINK	An FMC route uplink message was received, but was rejected due to errors.	Clear the message.
INVALID RTA UPLINK	An FMC RTA uplink message was received, but was rejected due to errors.	Clear the message.
INVALID TAKEOFF UPLINK	An FMC takeoff data uplink message was received, but was rejected due to errors.	Clear the message.



Intentionally
Blank



Controls and Indicators 12.10.1

- Fuel Control Panel 12.10.1
- Fuel Quantity Indications 12.10.4
- Fuel Alert Indications 12.10.5
- Fueling / Defueling / Measurement 12.10.8
 - Test Gages and Fueling Panel 12.10.10

System Description 12.20.1

- Introduction 12.20.1
- Fuel Feed 12.20.1
 - Fuel Pumps 12.20.1
 - Fuel Crossfeed 12.20.2
 - Fuel Shutoff Valves 12.20.2
 - Center Tank Fuel Scavenge Jet Pump 12.20.2
- Fuel Temperature 12.20.2
- APU Fuel Feed 12.20.2
- Fuel Quantity Indication 12.20.2
- Fueling/Defueling/Ground Transfer 12.20.3
- Fuel Tank Location and Capacities (Usable Fuel) 12.20.3
- Fuel Schematic 12.20.4

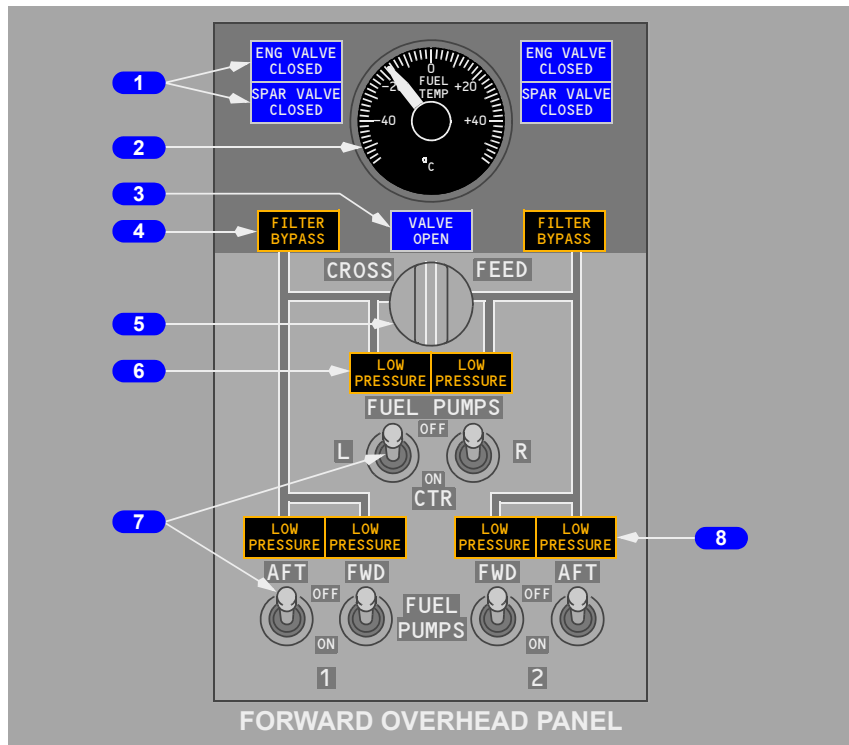

Intentionally
Blank

Fuel Control Panel

1 Engine Valve Closed (ENG VALVE CLOSED) and SPAR VALVE CLOSED Lights

Extinguished – related engine or spar fuel shutoff valve is open.

Illuminated (blue) –

- bright – related engine or spar fuel shutoff valve is in transit, or valve position and engine start lever or engine fire warning switch disagree.
- dim – related engine or spar fuel shutoff valve is closed.

2 FUEL Temperature (TEMP) Indicator

Indicates fuel temperature in No. 1 tank.

3 Crossfeed VALVE OPEN Light

Extinguished – crossfeed valve is closed.

Illuminated (blue) –

- bright – crossfeed valve is in transit, or valve position and CROSSFEED selector disagree.
- dim – crossfeed valve is open.

4 FILTER BYPASS Lights

Extinguished – fuel filter operating normally.

Illuminated (amber) – impending fuel filter bypass due to a contaminated filter.

5 CROSSFEED Selector

Controls fuel crossfeed valve.

Closed – isolates engine No. 1 and No. 2 fuel feed lines.

Open – connects engine No. 1 and No. 2 fuel feed lines.

6 Center Tank FUEL PUMP LOW PRESSURE Lights

YA371 - YA374, YC201, YC202, YC206, YE321 - YE325

Illuminated (amber) – fuel pump output pressure is low and FUEL PUMP switch is ON.

Note: With both Center (CTR) tank FUEL PUMP switches ON, illumination of both LOW PRESSURE lights illuminate MASTER CAUTION and FUEL system annunciator lights. Illumination of one LOW PRESSURE light illuminates MASTER CAUTION and FUEL system annunciator lights on MASTER CAUTION light recall.

Note: With one CTR tank FUEL PUMP switch OFF, illumination of opposite CTR tank LOW PRESSURE light illuminates the MASTER CAUTION and FUEL system annunciator lights.

Extinguished – fuel pump output pressure is normal, or FUEL PUMP switch is OFF.

737 Flight Crew Operations Manual

6 Center Tank FUEL PUMP LOW PRESSURE Lights

YA375 - YA377, YC203, YC207, YE326

Illuminated (amber) – fuel pump output pressure is low and FUEL PUMP switch is ON.

Note: With the Center (CTR) tank FUEL PUMP switches ON, continuous illumination of one LOW PRESSURE light for 10 seconds illuminates MASTER CAUTION and FUEL system annunciator lights.

Extinguished – fuel pump output pressure is normal, or FUEL PUMP switch is OFF.

7 FUEL PUMP Switches

ON – activates fuel pump.

OFF – deactivates fuel pump.

YA375 - YA377, YC203, YC207, YE326

Note: When a center tank fuel pump switch is set to OFF, the auto shutoff logic for that pump is reset. When the center tank fuel pump switch is set to ON after being OFF, the pump will again activate until the switch is set to OFF or auto shutoff logic deactivates it.

8 Main Tank FUEL PUMP LOW PRESSURE Lights

Illuminated (amber) – fuel pump output pressure is low, or FUEL PUMP switch is OFF.

Note: Two LOW PRESSURE lights illuminated in same tank illuminate MASTER CAUTION and FUEL system annunciator lights. One LOW PRESSURE light causes MASTER CAUTION and FUEL system annunciator lights to illuminate on MASTER CAUTION light recall.

Extinguished – fuel pump output pressure is normal.

Fuel Quantity Indications

YA371, YA372, YC201

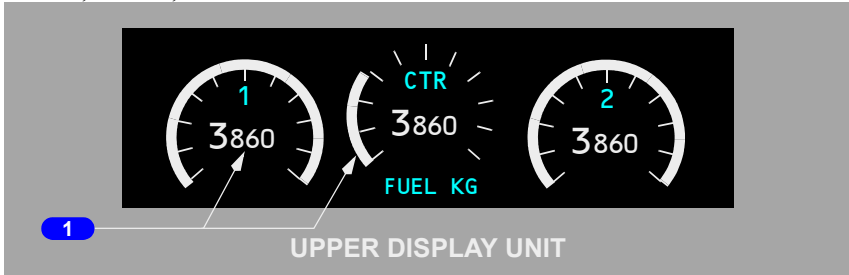

YA373 - YA377, YC202 - YE326

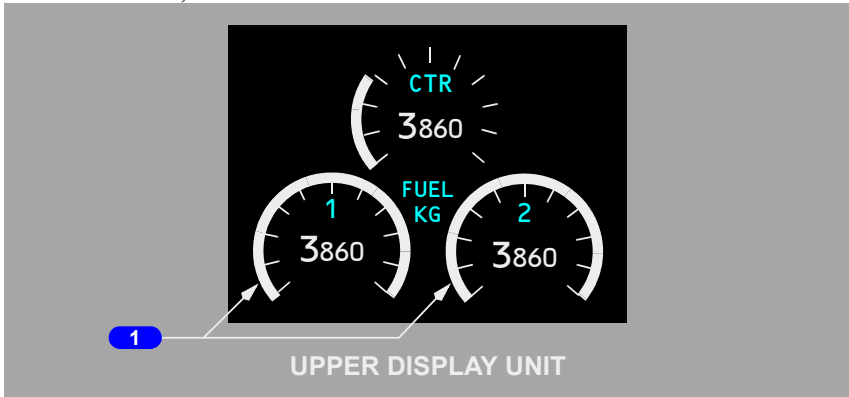

1 FUEL Quantity Indicators

Displayed (white) – indicates usable fuel in related tank:

- standby AC power is required.

Fuel Alert Indications

YA371, YA372, YC201

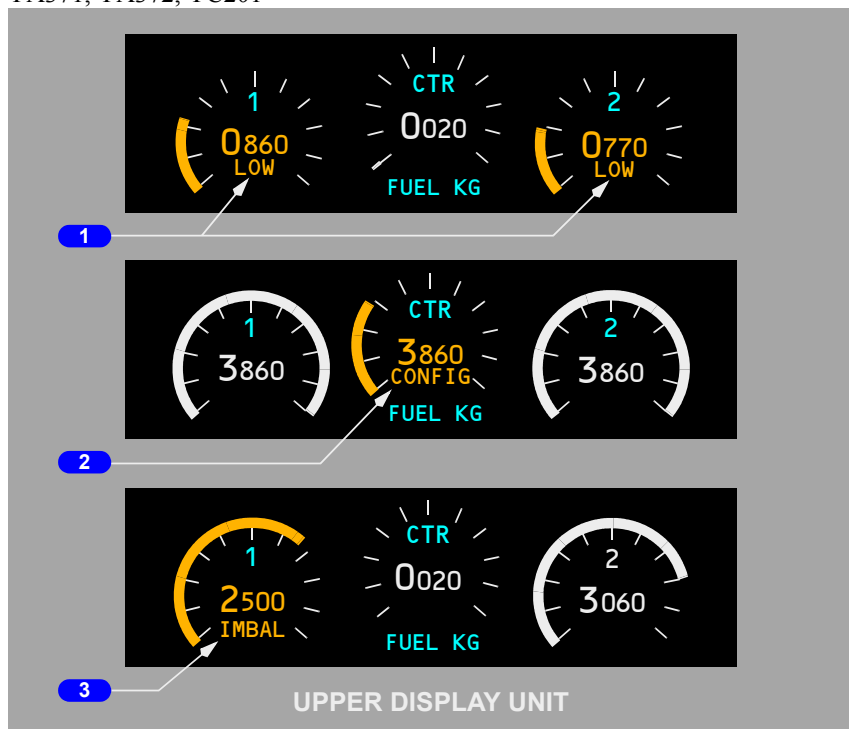

YA373 - YA377, YC202 - YE326



1 Fuel LOW Alert

Displayed (amber) –

- fuel tank quantity less than 907 kgs in related main tank
- display remains until fuel tank quantity is increased to 1134 kgs

The fuel quantity arc and digits on tank(s) with low fuel quantity turn amber.

2 Fuel Configuration (CONFIG) Alert

Displayed (amber) –

- either engine running
- center fuel tank quantity greater than 726 kgs; and
YA371 - YA374, YC201, YC202, YC206, YE321 - YE325
- both center fuel tank pumps producing low or no pressure
YA375 - YA377, YC203, YC207, YE326
- both center fuel tank pump switches positioned OFF

The quantity arc and digits on the center tank fuel quantity indicator turn amber.

Display remains until –

- both engines not running
- center fuel tank quantity less than 363 kgs
YA371 - YA374, YC201, YC202, YC206, YE321 - YE325
- one center fuel tank pump producing high pressure
YA375 - YA377, YC203, YC207, YE326
- one center fuel tank pump switch ON

The quantity arc and digits on the center tank fuel quantity indicator return to normal.

3 Fuel Imbalance (IMBAL) Alert

Displayed (amber) –

- main tanks differ by more than 453 kgs
- displayed below main tank with lower fuel quantity
- inhibited when airplane is on ground
- inhibited by fuel LOW indication when both indications exist
- displayed until imbalance is reduced to 91 kgs

The fuel quantity arc and digits on tank with lower fuel quantity turn amber

Fueling / Defueling / Measurement

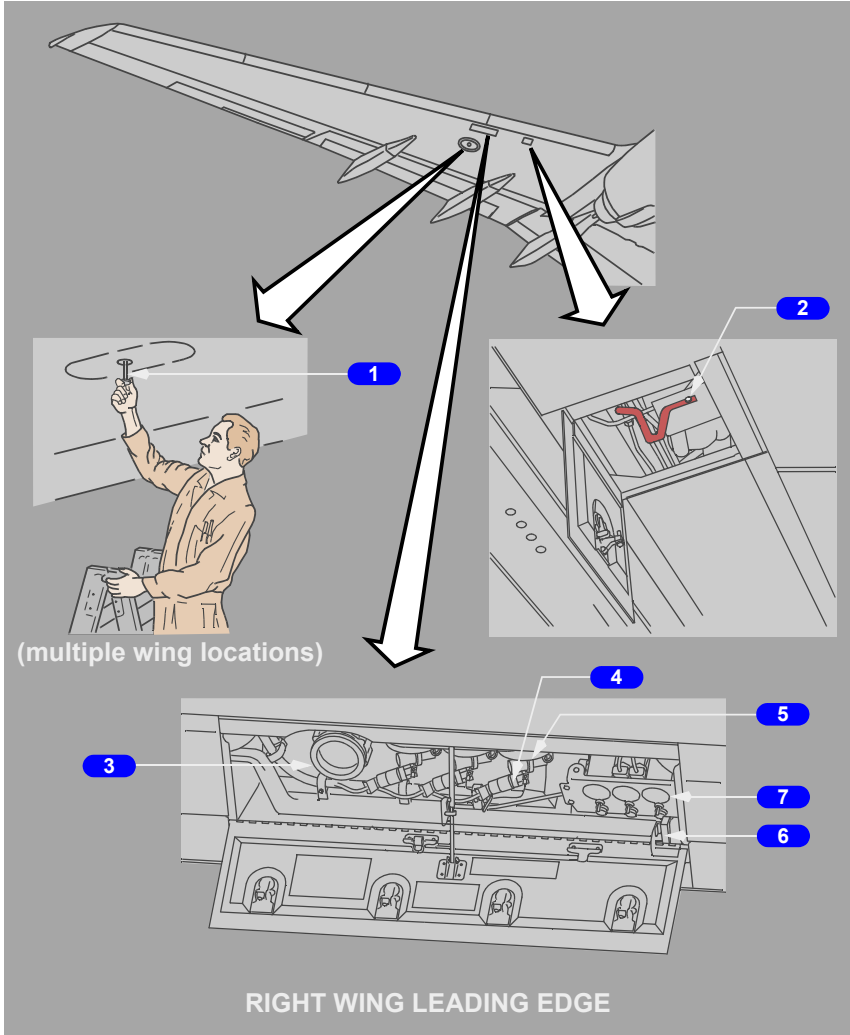

737 Flight Crew Operations Manual

1 Fuel Measuring Stick

Allows comparison of fuel quantity or weight as determined from measuring stick reading and fuel weight indicated by fuel quantity indicators:

- six fuel measuring sticks are installed in each main tank and four are installed in center tank
- reading is obtained by withdrawing measuring stick from tank and latching it magnetically to an internal float. Fuel depth is read where stick passes through wing skin.

2 Manual Defueling Valve

Open – interconnects engine feed system and fueling station for:

- defueling
- ground transfer of fuel.

Closed – isolates engine feed system from fueling station.

3 Fueling Receptacle

Hose connection receptacle for single point fueling.

4 Solenoid Override

Mechanically opens solenoid operated valve. Fuel valve opens if fuel pressure is available.

5 Fueling Valves

With the battery switch ON, and the refueling door open, fuel pressure opens valve.

6 Refueling Power Control Relay

Door closed – proximity sensor deactivates power to fueling system.

Door open – the fueling system is powered and panel lights illuminate.

7 Test Gages & Fueling Panel

Test Gages and Fueling Panel



8 FUELING INDICATION TEST SWITCH

(spring-loaded to OFF position)

TEST GAGES – checks operation of fuel quantity indicators.

FUEL DOOR SWITCH BYPASS – energizes fueling panel if refueling power control relay fails.

9 Fueling VALVE POSITION LIGHTS

Extinguished –

- fueling valve switch is OPEN and related tank is full
- fueling valve switch is CLOSED.

Illuminated (blue) – fueling valve switch is OPEN and related tank is not full.

10 Fueling Valve Switches

OPEN – energizes fueling valve in related tank.

CLOSED – de-energizes fueling valve in related tank.

11 FUEL Quantity (QTY) Indicators

Indicates total usable fuel tank quantity in related tank.

Introduction

The fuel system supplies fuel to the engines and the APU. Fuel is contained in three tanks located within the wings and wing center section.

Refer to Chapter 7, Engines, APU, for a description of the engine and APU fuel systems.

Fuel Feed

Both engines are normally pressure fed from the center tank until the center tank quantity decreases to near zero. The engines are normally then pressure fed from their respective main tanks. Check valves are located throughout the fuel system to ensure the proper direction of fuel flow and to prevent transfer of fuel between tanks.

Fuel Pumps

Each fuel tank uses two AC powered fuel pumps which are cooled and lubricated by fuel passing through the pump. Center tank pumps produce higher pressure than main tank pumps. This ensures that center tank fuel is used before main tank fuel, even though all fuel pumps are operating. Individual pressure sensors monitor the output pressure of each pump.

YA375 - YA377, YC203, YC207, YE326

Each center tank pump will automatically shut off, after a short delay, when that pump's sensor detects low output pressure.

Note: Fuel pump LOW PRESSURE lights may flicker when tank quantity is low and the airplane is in a climb, descent, or on the ground with a nose-down attitude.

Suction Feed

When main tank fuel pump pressure is low, each engine can draw fuel from its corresponding main tank through a suction feed line that bypasses the pumps. As the airplane climbs, dissolved air is released from the fuel in the tank due to the decrease in air pressure. This air may collect in the suction feed line and restrict fuel flow. At high altitude, thrust deterioration or engine flameout may occur as a result of the fuel flow reduction.

The dissolved air in the fuel tank will eventually deplete after reaching cruise altitude. The depletion time is dependent upon airplane altitude, fuel temperature, and type of fuel. Once the dissolved air is depleted, the engine may be capable of suction feed operation at cruise power.

The main tank bypass valves may also be used for suction defueling.

Fuel Crossfeed

The engine fuel manifolds are interconnected by use of the crossfeed valve. The valve is DC motor operated from the battery bus.

Fuel pressure can be provided from a main tank with operating fuel pumps to both engines by opening the fuel crossfeed valve. Continued crossfeed use will result in a progressive fuel imbalance.

Fuel Shutoff Valves

Spar fuel shutoff valves are located at the engine-mounting wing stations. The valves are DC motor operated from the hot battery bus. The engine fuel shutoff valves are fuel actuated, solenoid controlled valves powered from the battery bus. Both the spar fuel shutoff valve and the engine fuel shutoff valve close whenever their respective engine fire warning switch is pulled or engine start lever is placed to CUTOFF.

Center Tank Fuel Scavenge Jet Pump

With the main tank fuel pump No. 1 FWD Switch ON, the center tank fuel scavenge jet pump operates automatically to transfer any remaining center tank fuel to main tank No. 1. Fuel transfer begins when main tank No. 1 quantity is about one-half. Once the fuel scavenge process begins, it continues for the remainder of the flight.

Fuel Temperature

The FUEL TEMP indicator located on the fuel control panel displays fuel temperature. A sensor in main tank No. 1 allows monitoring of fuel temperature. The temperature indicating system uses AC electrical power.

APU Fuel Feed

When AC fuel pumps are operating, fuel for the APU is supplied from the left side of the fuel manifold. If the AC fuel pumps are not operating, fuel is suction fed from main tank No. 1.

Fuel Quantity Indication

The fuel quantity indication system calculates the usable fuel quantity in each tank. The fuel quantity in each tank is displayed on the upper display unit and on the fueling station panel.

Fueling/Defueling/Ground Transfer

Rapid fueling and defueling is accomplished at the single-point pressure fueling station in the right wing. The fueling station is also used for the ground transfer of fuel between tanks.

The manual defueling valve, located outboard of engine No. 2, interconnects the engine feed system and the fueling station. It is opened for defueling and tank to tank transfer operations.

A shutoff system is used during fueling to automatically close the fueling valve in each fuel tank when the tank is full.

Fuel Tank Location and Capacities (Usable Fuel)

Main tanks No. 1 and No. 2 are integral with the wing structure. The center tank lies between the wing roots within the fuselage area and extends out into the wing structure.

These figures represent approximate amounts of usable fuel. The appropriate weight and balance control and loading manual gives exact figures for all conditions.

TANK	LITERS	KILOGRAMS*
NO. 1	4,876	3,915
NO. 2	4,876	3,915
CENTER	16,273	13,066
TOTAL	26,025	20,896

* Usable fuel at level attitude, fuel density = 0.8029 kilograms per liter

Fuel Schematic

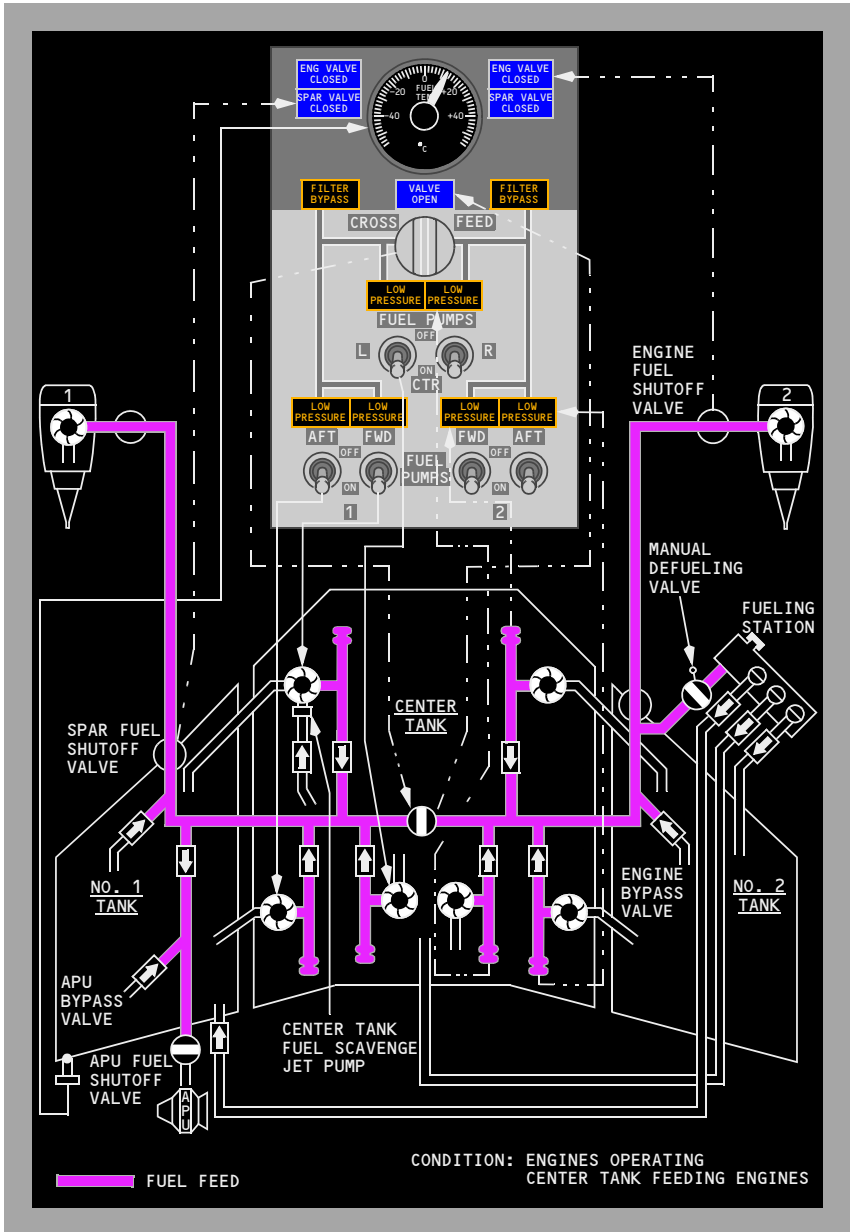



Hydraulics

Chapter 13

Table of Contents

Section 0

Controls and Indicators **13.10.1**

 Hydraulic Panel 13.10.1

 Hydraulic Indications 13.10.2

 Flight Control Panel 13.10.4

System Description **13.20.1**

 Introduction 13.20.1

 Hydraulic Power Distribution Schematic 13.20.1

 A and B Hydraulic Systems 13.20.2

 A and B Hydraulic System Pumps 13.20.2

 System A Hydraulic Leak 13.20.3

 System B Hydraulic Leak 13.20.3

 Power Transfer Unit 13.20.3

 Landing Gear Transfer Unit 13.20.4

 Standby Hydraulic System 13.20.4

 Automatic Operation 13.20.5

 Standby Hydraulic System Schematic 13.20.6

 Standby Hydraulic System Leak 13.20.8

 Variations in Hydraulic Quantity Indications 13.20.8

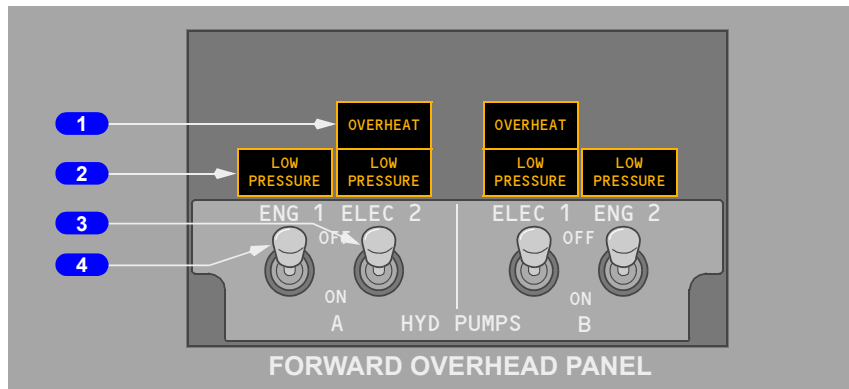

Intentionally
Blank

Hydraulic Panel

1 Electric Hydraulic Pump OVERHEAT Lights

Illuminated (amber) – Hydraulic fluid used to cool and lubricate the corresponding electric motor driven pump has overheated or the pump itself has overheated.

2 Hydraulic Pump LOW PRESSURE Lights

Illuminated (amber) – output pressure of associated pump is low.

Note: When an engine fire warning switch is pulled, the low pressure light is deactivated.

3 ELECTRIC HYDRAULIC PUMPS Switches

ON – provides power to associated electric motor-driven pump.

OFF – electrical power removed from pump.

4 ENGINE HYDRAULIC PUMPS Switches

ON – de-energizes blocking valve in pump to allow pump pressure to enter system.

Note: Should remain ON at shutdown to prolong solenoid life.

OFF – energizes blocking valve to block pump output.

Hydraulic Indications

YA371, YA372, YC201

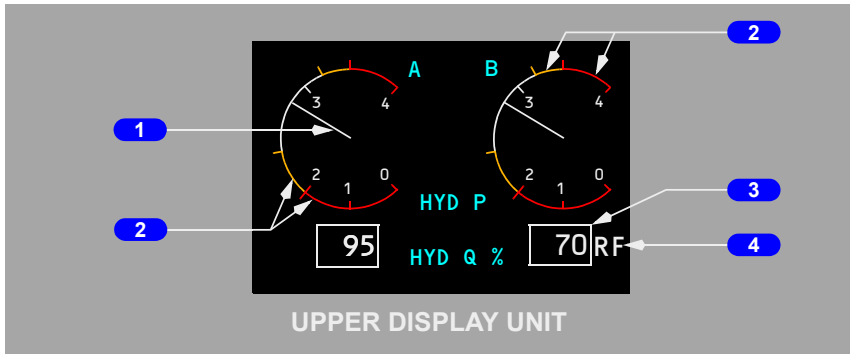

1 HYDRAULIC System PRESSURE Indications

Indicates system pressure:

- displayed (white) - normal operating range
- displayed (amber) - caution range
- displayed (red) - operating limit reached.

Note: When both pumps for a system are OFF, respective pointer reads zero.

2 Hydraulic Pressure Amber Bands/Redlines

Displayed (amber) - low/high hydraulic pressure caution range.

Displayed (red) - low/high hydraulic pressure operating limit.

3 HYDRAULIC System QUANTITY Indications

Indicates digital percentage (0% to 106%) of hydraulic quantity.

Note: Quantity also displayed at each reservoir.

4 REFILL Indication (RF) (white)

Illuminated (white) – hydraulic quantity below 76%.

Note: Valid only when airplane is on ground with both engines shutdown or after landing with flaps up during taxi-in.

737 Flight Crew Operations Manual

YA373 - YA377, YC202 - YE326

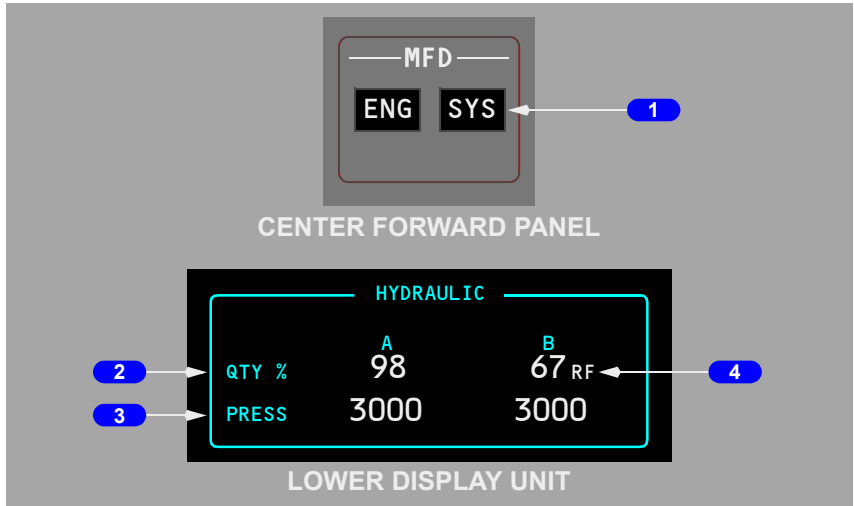

1 MFD System (SYS) Switch

Push – SYS

- displays hydraulic indications on lower DU; or if the lower DU is unavailable, displays it on upper DU or inboard DU based on the position of the display select panel
- second push blanks lower DU.

2 HYDRAULIC System QUANTITY Indications (white)

Indicates digital percentage (0% to 106%) of hydraulic quantity.

Note: Quantity also displayed at each reservoir.

3 HYDRAULIC System PRESSURE Indications (white)

Indicates system pressure:

- Normal pressure – 3000 psi
- Maximum pressure – 3500 psi.

Note: When both pumps for a system are OFF, the indication may read hydraulic system reservoir pressure, normally less than 100 psi.

4 REFILL Indication (RF) (white)

Illuminated (white) – hydraulic quantity below 76%.

Note: Valid only when airplane is on ground with both engines shutdown or after landing with flaps up during taxi-in.

Flight Control Panel

YA371

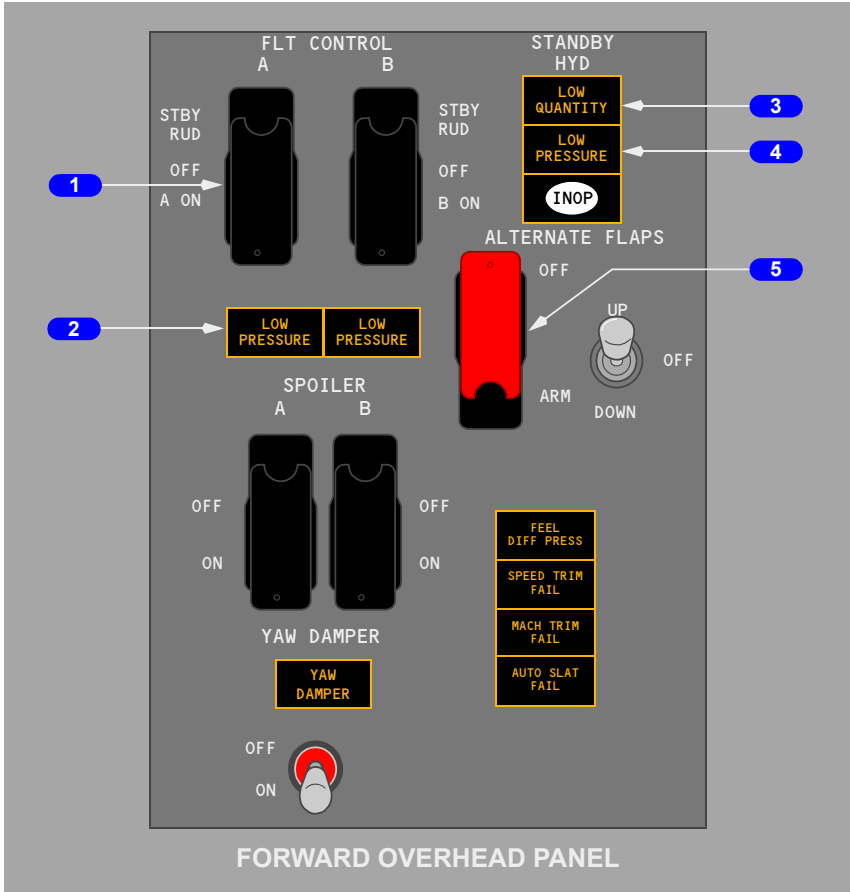

737 Flight Crew Operations Manual

YA372 - YE326

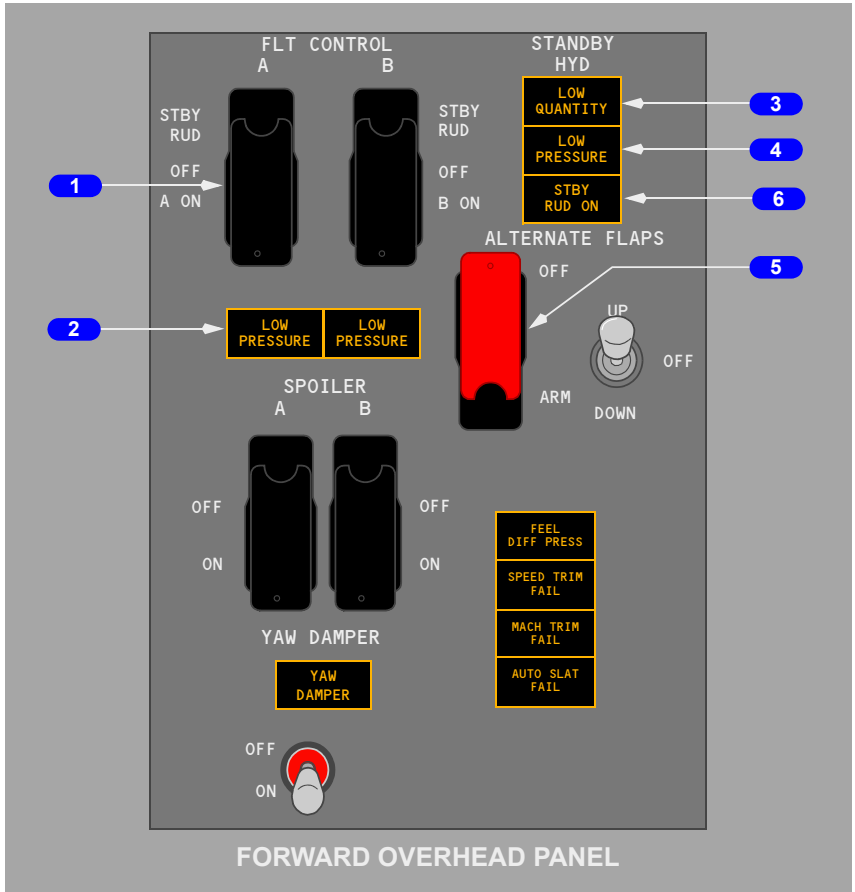

1 FLIGHT CONTROL Switches

STBY RUD – activates standby pump and opens standby rudder shutoff valve to pressurize standby rudder power control unit.

OFF – closes flight control shutoff valve isolating ailerons, elevators and rudder from associated hydraulic system pressure.

ON (guarded position) – normal operating position.

2 Flight Control LOW PRESSURE Lights

Illuminated (amber) –

- indicates low hydraulic system (A or B) pressure to ailerons, elevator and rudder
- deactivated when associated FLIGHT CONTROL switch is positioned to STBY RUD and standby rudder shutoff valve opens.

3 STANDBY HYDRAULIC LOW QUANTITY Light

Illuminated (amber) –

- indicates low quantity in standby hydraulic reservoir
- always armed.

4 STANDBY HYDRAULIC LOW PRESSURE Light

Illuminated (amber) –

- indicates output pressure of standby pump is low
- armed only when standby pump operation has been selected or automatic standby function is activated.

5 ALTERNATE FLAPS Master Switch

OFF (guarded position) – normal operating position.

ARM – closes trailing edge flap bypass valve, activates standby pump, and arms ALTERNATE FLAPS position switch.

6 STBY RUD ON Light

YA372 - YE326

Illuminated (amber) - indicates the standby hydraulic system is commanded on to pressurize the standby rudder power control unit.

Hydraulics

System Description

Chapter 13

Section 20

Introduction

The airplane has three hydraulic systems: A, B and standby. The standby system is used if system A and/or B pressure is lost. The hydraulic systems power the following airplane systems:

- flight controls
- leading edge flaps and slats
- trailing edge flaps
- landing gear
- wheel brakes
- nose wheel steering
- thrust reversers
- autopilots.

Either A or B hydraulic system can power all flight controls with no decrease in airplane controllability.

Each hydraulic system has a fluid reservoir located in the main wheel well area. System A and B reservoirs are pressurized by bleed air. The standby system reservoir is connected to the system B reservoir for pressurization and servicing. Pressurization of all reservoirs ensures positive fluid flow to all hydraulic pumps.

Hydraulic Power Distribution Schematic

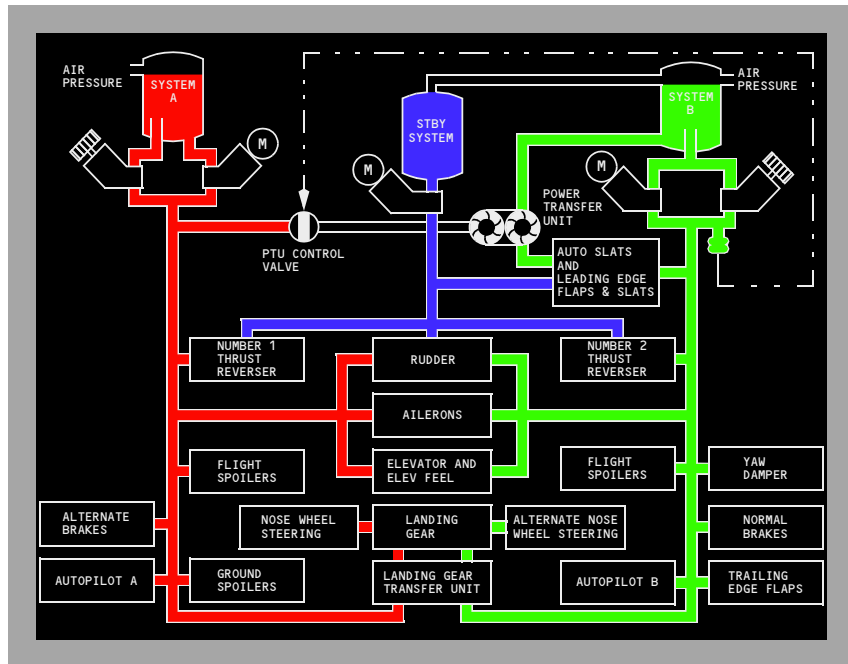

A and B Hydraulic Systems

Components powered by hydraulic systems A and B are:

- | System A | System B |
|--|--|
| <ul style="list-style-type: none">• ailerons• rudder• elevator and elevator feel• flight spoilers
(two on each wing)• ground spoilers• alternate brakes• No. 1 thrust reverser• autopilot A• normal nose wheel steering• landing gear• power transfer unit (PTU) | <ul style="list-style-type: none">• ailerons• rudder• elevator and elevator feel• flight spoilers
(two on each wing)• leading edge flaps and slats• normal brakes• No. 2 thrust reverser• autopilot B• alternate nose wheel steering• landing gear transfer unit.• autoslats• yaw damper• trailing edge flaps. |

A and B Hydraulic System Pumps

Both A and B hydraulic systems have an engine-driven pump and an AC electric motor-driven pump. The system A engine-driven pump is powered by the No. 1 engine and the system B engine-driven pump is powered by the No. 2 engine. An engine-driven hydraulic pump supplies approximately 4 times the fluid volume of the related electric motor-driven hydraulic pump.

The ENG 1 (system A) or ENG 2 (system B) pump ON/OFF switch controls the engine-driven pump output pressure. Positioning the switch to OFF isolates fluid flow from the system components. However, the engine-driven pump continues to rotate as long as the engine is operating. Pulling the engine fire warning switch shuts off the fluid flow to the engine-driven pump and deactivates the related LOW PRESSURE light.

The ELEC 2 (system A) or ELEC 1 (system B) pump ON/OFF switch controls the related electric motor-driven pump. If an overheat is detected in either system, the related OVERHEAT light illuminates, power is removed from the pump and the LOW PRESSURE light illuminates.

Note: Loss of the system A engine-driven hydraulic pump, and a heavy demand on system A, may result in an intermittent LOW PRESSURE light for the remaining electric motor-driven hydraulic pump. The system A flight controls LOW PRESSURE light, Master Caution light, and the FLT CONT and HYD system annunciator lights also illuminate.

737 Flight Crew Operations Manual

Hydraulic fluid used for cooling and lubrication of the pumps passes through a heat exchanger before returning to the reservoir. The heat exchanger for system A is located in main fuel tank No. 1 and for system B is in main fuel tank No. 2.

CAUTION: Minimum fuel for ground operation of electric motor-driven pumps is 760 Kgs in the related main tank.

Pressure switches, located in the engine-driven and electric motor-driven pump output lines, send signals to illuminate the related LOW PRESSURE light if pump output pressure is low. A check valve, located in each output line, isolates the related pump from the system. The related system pressure transmitter sends the combined pressure of the engine-driven and electric motor-driven pump to the related hydraulic system pressure indication.

System A Hydraulic Leak

If a leak develops in the engine-driven pump or its related lines, a standpipe in the reservoir prevents a total system fluid loss. With fluid level at the top of the standpipe, the reservoir quantity displayed indicates approximately 20% full. System A hydraulic pressure is maintained by the electric motor-driven pump.

If a leak develops in the electric motor-driven pump or its related lines, or components common to both the engine and electric motor-driven pumps, the quantity in the reservoir steadily decreases to zero and all system pressure is lost.

System B Hydraulic Leak

If a leak develops in either pump, line or component of system B, the quantity decreases until it indicates approximately zero and system B pressure is lost. The system B reservoir has one standpipe which supplies fluid to both the engine-driven pump and the electric motor-driven pump. However, with fluid level at the top of the standpipe, fluid remaining in the system B reservoir is sufficient for power transfer unit operation.

A leak in system B does not affect the operation of the standby hydraulic system.

Power Transfer Unit

The purpose of the PTU is to supply the additional volume of hydraulic fluid needed to operate the autoslats and leading edge flaps and slats at the normal rate when system B engine-driven hydraulic pump volume is lost. The PTU uses system A pressure to power a hydraulic motor-driven pump, which pressurizes system B hydraulic fluid. The PTU operates automatically when all of the following conditions exist:

- system B engine-driven pump hydraulic pressure drops below limits
- airborne
- flaps are less than 15 but not up.

Landing Gear Transfer Unit

The purpose of the landing gear transfer unit is to supply the volume of hydraulic fluid needed to raise the landing gear at the normal rate when system A engine-driven pump volume is lost. The system B engine-driven pump supplies the volume of hydraulic fluid needed to operate the landing gear transfer unit when all of the following conditions exist:

- airborne
- No. 1 engine RPM drops below a limit value
- landing gear lever is positioned UP
- either main landing gear is not up and locked.

Standby Hydraulic System

The standby hydraulic system is provided as a backup if system A and/or B pressure is lost. The standby system can be activated manually or automatically and uses a single electric motor-driven pump to power:

- thrust reversers
- rudder
- leading edge flaps and slats (extend only)
- standby yaw damper.

Manual Operation

Positioning either FLT CONTROL switch to STBY RUD:

- activates the standby electric motor-driven pump
- shuts off the related hydraulic system pressure to ailerons, elevators and rudder by closing the flight control shutoff valve
- opens the standby rudder shutoff valve
- deactivates the related flight control LOW PRESSURE light when the standby rudder shutoff valve opens
- allows the standby system to power the rudder and thrust reversers.
YA372 - YE326
- illuminates the STBY RUD ON, Master Caution, and Flight Controls (FLT CONT) lights.

Positioning the ALTERNATE FLAPS master switch to ARM, (refer to Chapter 9, Flight Controls for a more complete explanation):

- activates the standby electric motor-driven pump
- closes the trailing edge flap bypass valve
- arms the ALTERNATE FLAPS position switch
- allows the standby system to power the leading edge flaps and slats and thrust reversers.

Automatic Operation

Automatic operation is initiated when the following conditions exist:

- loss of system A or B, and
- flaps extended, and
- airborne, or wheel speed greater than 60 kts, and
- FLT CONTROL switch A or B Hydraulic System ON

YA372 - YE326

OR:

- the main PCU Force Fight Monitor (FFM) trips

Automatic operation:

- activates the standby electric motor-driven pump
- opens the standby rudder shutoff valve
- allows the standby system to power the rudder and thrust reversers.

YA372 - YE326

- illuminates the STBY RUD ON, Master Caution, and Flight Controls (FLT CONT) lights.

Standby Hydraulic System Schematic

YA371

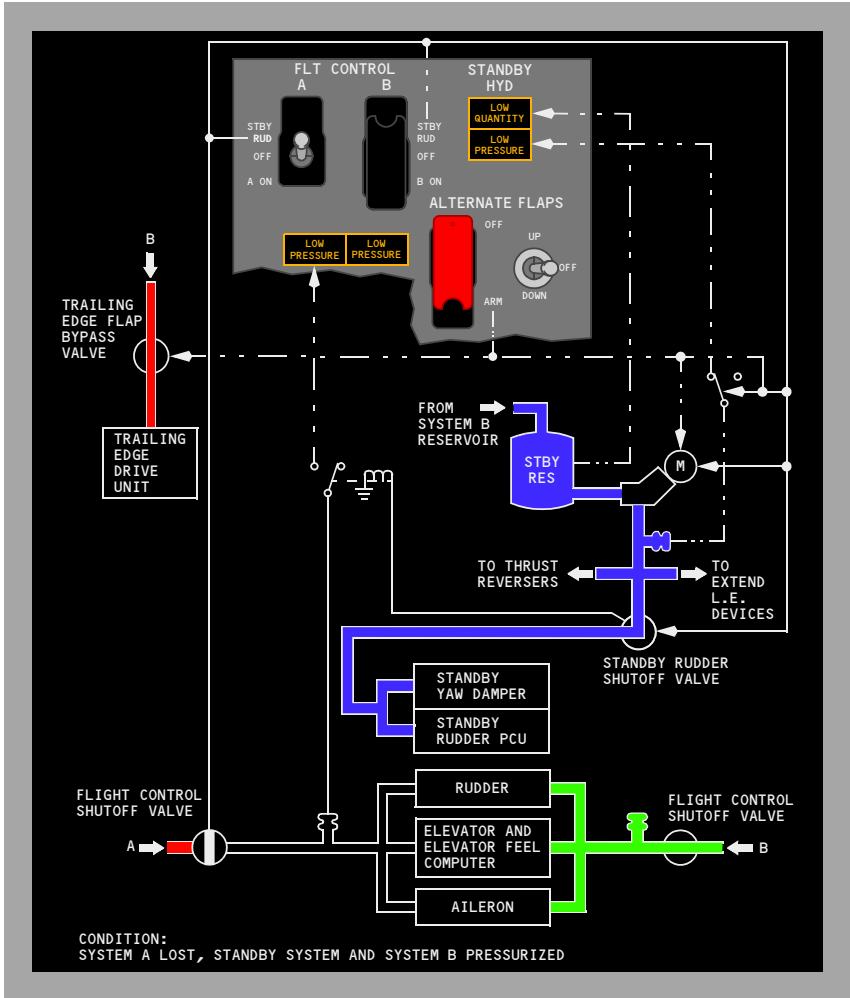

737 Flight Crew Operations Manual

YA372 - YE326

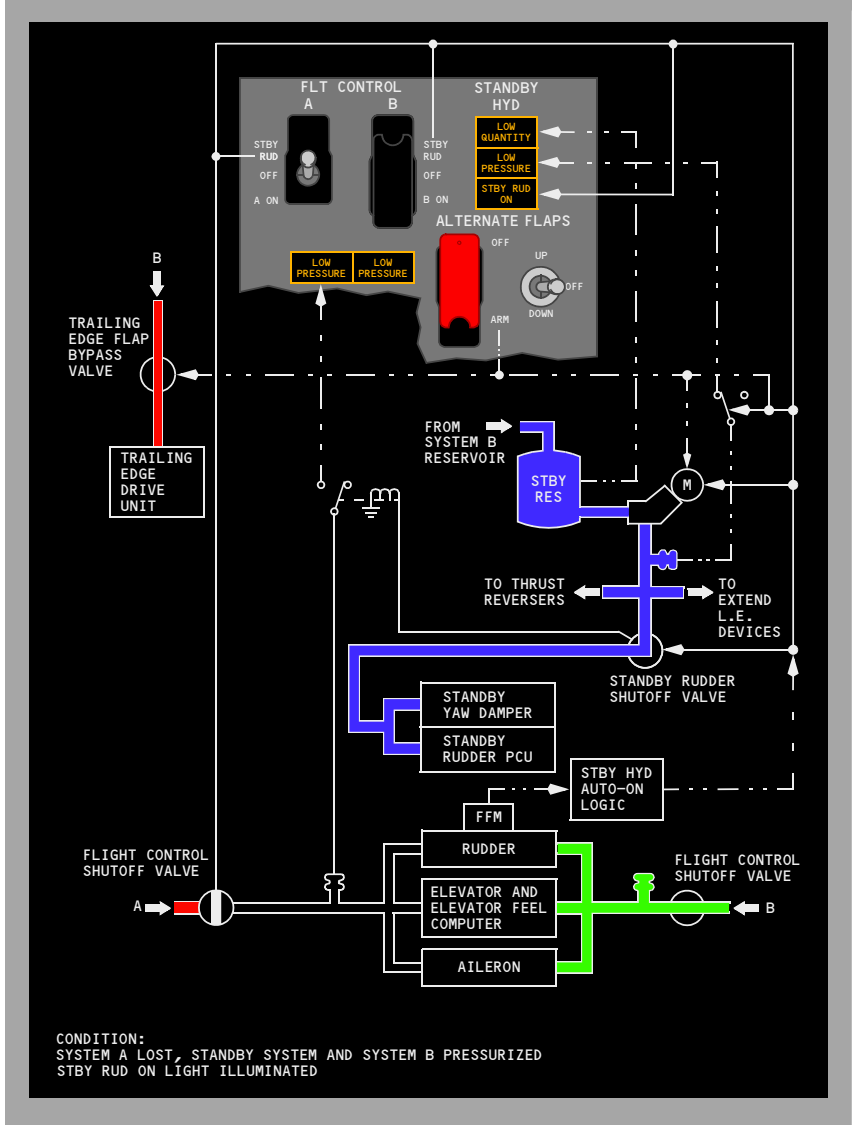

Standby Hydraulic System Leak

If a leak occurs in the standby system, the standby reservoir quantity decreases to zero. The LOW QUANTITY light illuminates when the standby reservoir is approximately half empty. System B continues to operate normally, however, the system B reservoir fluid level indication decreases and stabilizes at approximately 72% full.

Variations in Hydraulic Quantity Indications

During normal operations, variations in hydraulic quantity indications occur when:

- the system becomes pressurized after engine start
- raising or lowering the landing gear or leading edge devices
- cold soaking occurs during long periods of cruise.

These variations have little effect on systems operation.

If the hydraulic system is not properly pressurized, foaming can occur at higher altitudes. Foaming can be recognized by pressure fluctuations and the blinking of the related LOW PRESSURE lights. The MASTER CAUTION and HYD annunciator lights may also illuminate momentarily.



Controls and Indicators	14.10.1
Landing Gear Panel	14.10.1
Landing Gear Indicator Lights	14.10.2
Manual Gear Extension	14.10.3
Autobrake and Antiskid Controls	14.10.4
Parking Brake	14.10.5
Hydraulic Brake Pressure Indicator	14.10.6
Rudder/Brake Pedals	14.10.6
Nose Wheel Steering Switch	14.10.7
Nose Wheel Steering Wheel	14.10.7
System Description	14.20.1
Introduction	14.20.1
Landing Gear Operation	14.20.1
Landing Gear Retraction	14.20.1
Landing Gear Extension	14.20.2
Landing Gear Manual Extension	14.20.2
Nose Wheel Steering	14.20.3
Brake System	14.20.3
Normal Brake System	14.20.3
Alternate Brake System	14.20.3
Brake Accumulator	14.20.3
Antiskid Protection	14.20.4
Autobrake System	14.20.4
Parking Brake	14.20.6
Air/Ground System	14.20.6
Air/Ground System Logic Table	14.20.6



Intentionally
Blank

Landing Gear Panel

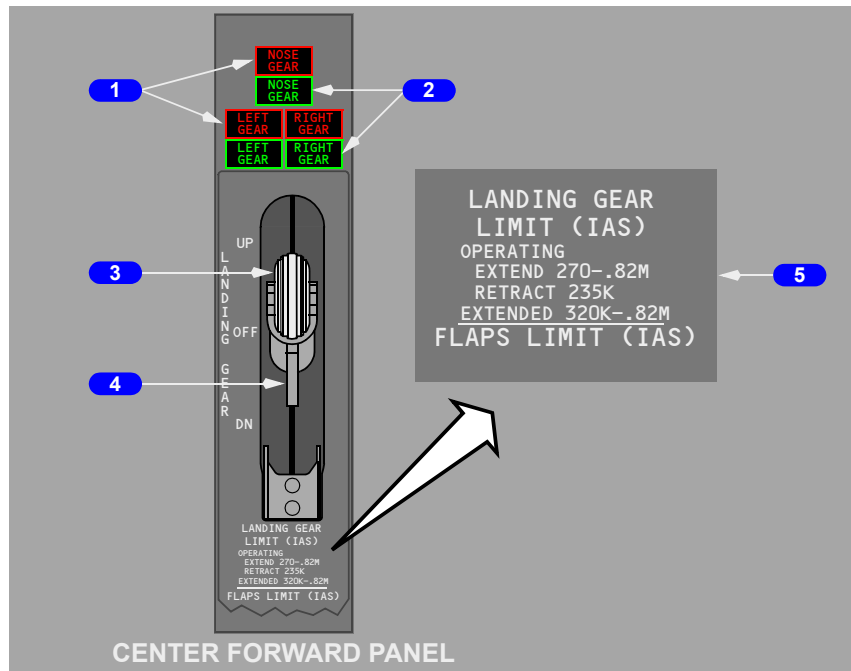

1 Landing Gear Indicator Lights (top)

Illuminated (red) –

- landing gear is not down and locked (with either or both forward thrust levers retarded to idle, and below 800 feet AGL).
- related landing gear is in disagreement with LANDING GEAR lever position (in transit or unsafe).

Extinguished -

- landing gear is up and locked with landing gear lever UP or OFF
- landing gear is down and locked with landing gear lever DN.

2 Landing Gear Indicator Lights (bottom)

Illuminated (green) – related gear down and locked.

Note: Landing gear warning horn is deactivated with all gear down and locked.

Note: Landing gear is down and locked as long as one green landing gear indicator light (center panel or overhead panel) for each gear is illuminated.

Extinguished – landing gear is not down and locked.

3 LANDING GEAR Lever

UP – landing gear retract.

OFF – hydraulic pressure is removed from landing gear system.

DN – landing gear extend.

4 Override Trigger

Allows LANDING GEAR lever to be raised, bypassing the landing gear lever lock.

5 LANDING GEAR LIMIT Speed Placard

Indicates maximum speed while operating landing gear and after gear extension.

Landing Gear Indicator Lights

This is a redundant but separate set of landing gear indicator circuits and lights.

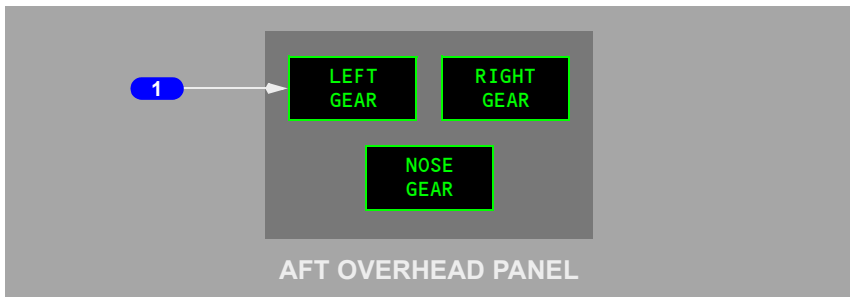

737 Flight Crew Operations Manual

1 Landing Gear Indicator Lights (overhead)

Illuminated (green) – related gear down and locked.

Note: Landing gear warning horn is deactivated with all gear down and locked.

Note: Landing gear is down and locked as long as one green landing gear indicator light (center panel or overhead panel) for each gear is illuminated.

Extinguished – landing gear is not down and locked.

Manual Gear Extension

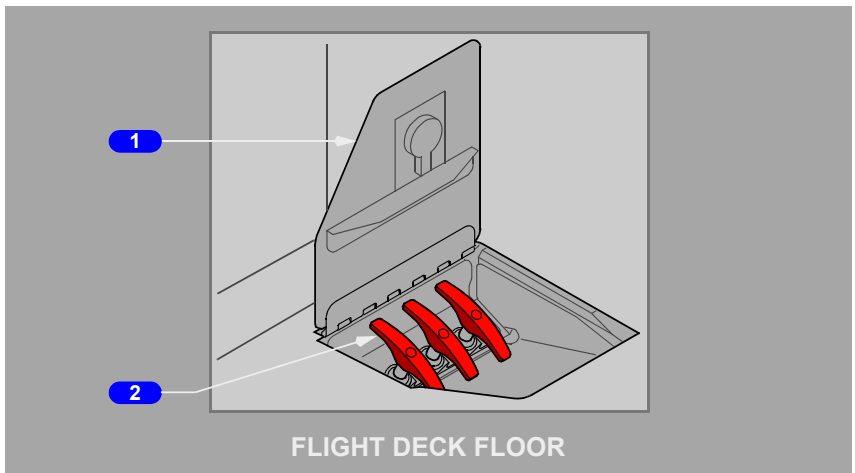

1 Manual Extension Access Door

Open –

- manual landing gear extension is possible with landing gear lever in any position
- normal landing gear extension is still possible if hydraulic system A pressure is available
- landing gear retraction is disabled.

Closed – landing gear operate normally.

2 Manual Gear Extension Handles

Right main, nose, left main – Each landing gear uplock is released when related handle is pulled to its limit, approximately 24 inches (61 cm).

Autobrake and Antiskid Controls

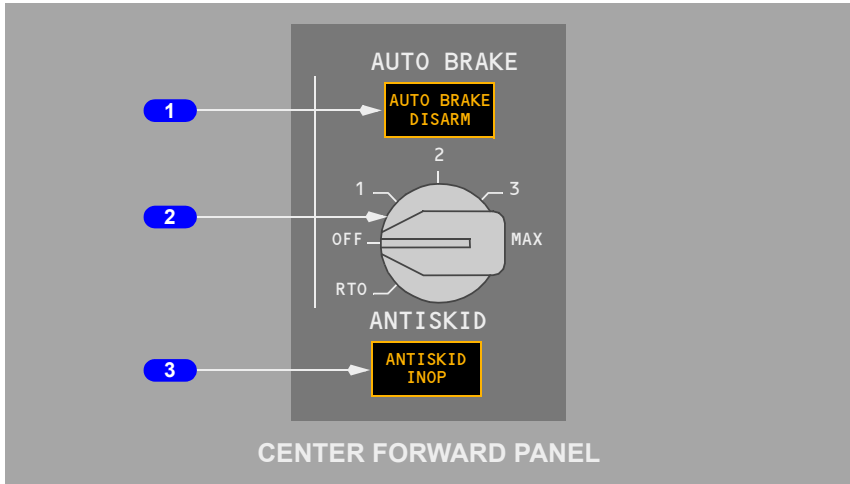

1 AUTO BRAKE DISARM Light

Illuminated (amber) –

- SPEED BRAKE lever moved to down detent during RTO or landing
- manual brakes applied during RTO or landing
- thrust lever(s) advanced during RTO or landing
 - except during first 3 seconds after touchdown for landing
- landing made with RTO selected
- RTO mode selected on ground
 - illuminates for one to two seconds then extinguishes
- a malfunction exists in automatic braking system.

Extinguished –

- AUTO BRAKE select switch set to OFF
- autobrakes armed.

2 AUTO BRAKE Select Switch

OFF – autobrake system deactivated.

1, 2, 3, or MAX –

- selects desired deceleration rate for landing
- switch must be pulled out to select MAX deceleration.

RTO – automatically applies maximum brake pressure when thrust levers are retarded to idle at or above 90 knots.

3 Antiskid Inoperative (ANTISKID INOP) Light

Illuminated (amber) – a system fault is detected by antiskid monitoring system.

Extinguished – antiskid system operating normally.

Parking Brake

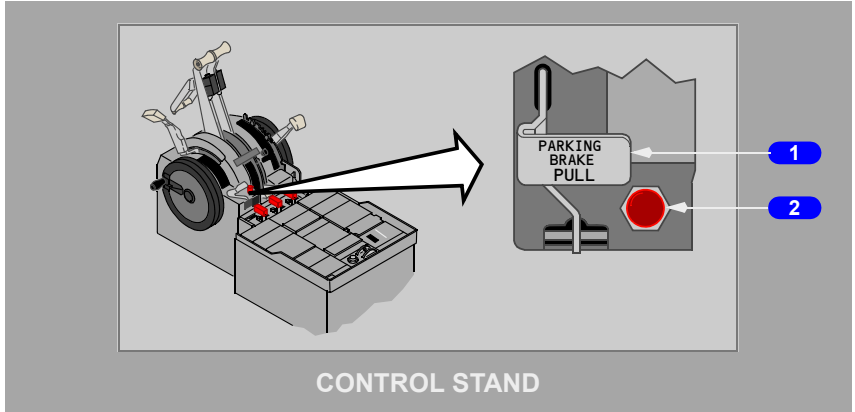

1 PARKING BRAKE Lever

Forward – parking brakes released.

Aft – sets parking brakes when either Captain’s or First Officer’s brake pedals are fully depressed.

2 Parking Brake Warning Light

Illuminated (red) – parking brake is set (light operates from battery power).

Extinguished – parking brake is released.

Hydraulic Brake Pressure Indicator

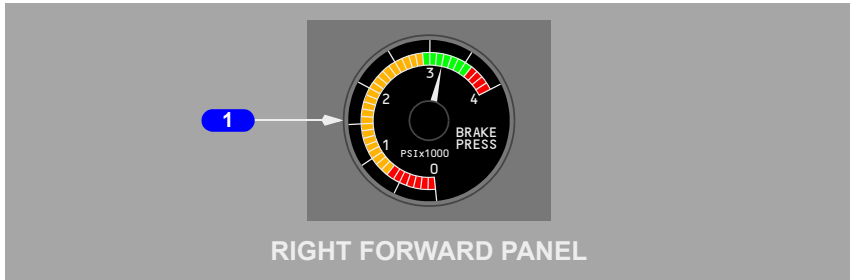

1 Hydraulic Brake Pressure (HYD BRAKE PRESS) Indicator

Indicates brake accumulator pressure:

- normal pressure – 3000 psi
- maximum pressure – 3500 psi
- normal precharge – 1000 psi.

Rudder/Brake Pedals

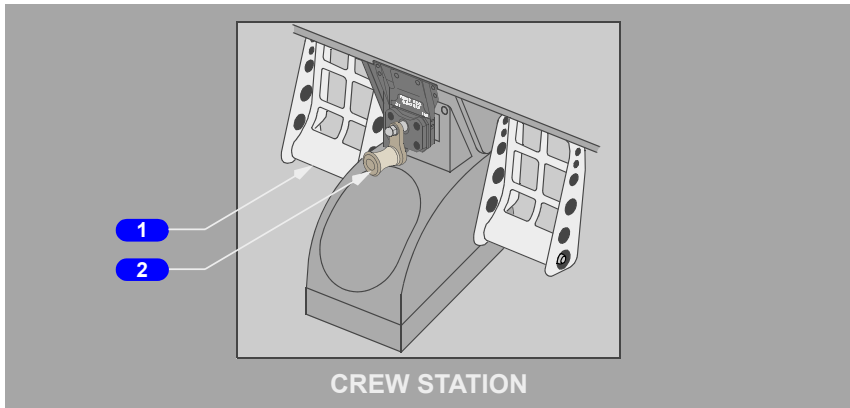

1 Rudder/Brake Pedals

Push full pedal – turns nose wheel up to 7 degrees in either direction.

Push top of pedal only – activates wheel brakes.

Refer to Chapter 9 Flight Controls for rudder description.

2 RUDDER PEDAL ADJUSTMENT Crank

AFT (counter-clockwise) – adjusts rudder pedals aft.

FWD (clockwise) – adjusts rudder pedals forward.

Nose Wheel Steering Switch

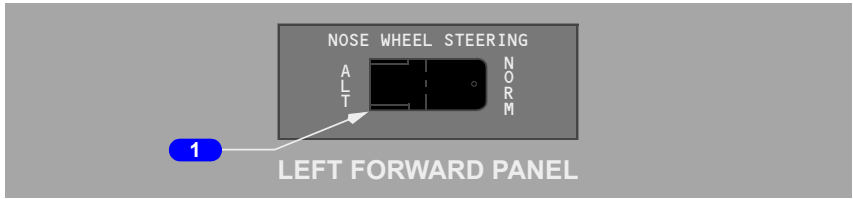

1 NOSE WHEEL STEERING Switch

ALT – hydraulic system B provides power for nose wheel steering.

NORM (guarded position) – hydraulic system A provides power for nose wheel steering.

Nose Wheel Steering Wheel

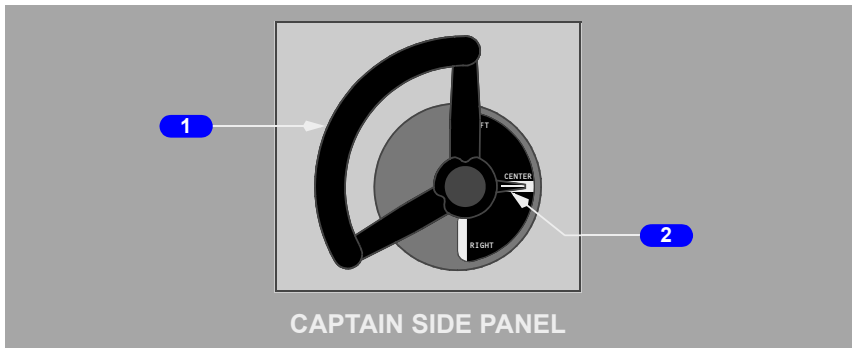

1 Nose Wheel Steering Wheel

Rotate –

- turns nose wheel up to 78 degrees in either direction
- overrides rudder pedal steering.

2 Nose Wheel Steering Indicator

LEFT – indicates nose wheel steering displacement left of center position.

CENTER – normal straight ahead position.

RIGHT – indicates nose wheel steering displacement right of center position.

Intentionally
Blank

Introduction

The airplane has two main landing gear and a single nose gear. Each main gear is a conventional two-wheel landing gear unit. The nose gear is a conventional steerable two-wheel unit.

Hydraulic power for retraction, extension, and nose wheel steering is normally supplied by hydraulic system A. A manual landing gear extension system and an alternate source of hydraulic power for nose wheel steering are also provided.

The normal brake system is powered by hydraulic system B. The alternate brake system is powered by hydraulic system A. Antiskid protection is provided on both brake systems, but the autobrake system is available only with the normal brake system.

Landing Gear Operation

The landing gear are normally controlled by the LANDING GEAR lever. On the ground, a landing gear lever lock, prevents the LANDING GEAR lever from moving to the up position. An override trigger in the lever may be used to bypass the landing gear lever lock. In flight, the air/ground system energizes a solenoid which opens the lever lock.

Landing Gear Retraction

When the LANDING GEAR lever is moved to UP, the landing gear begins to retract. During retraction, the brakes automatically stop rotation of the main gear wheels. After retraction, the main gear are held in place by mechanical uplocks. Rubber seals and oversized hubcaps complete the fairing of the outboard wheels.

The nose wheels retract forward into the wheel well and nose wheel rotation is stopped by snubbers. The nose gear is held in place by an overcenter lock and enclosed by doors which are mechanically linked to the gear.

Hydraulic pressure is removed from the landing gear system with the LANDING GEAR lever in the OFF position.

If a main landing gear tire is damaged during takeoff, it is possible that braking of the main gear wheels during retraction may be affected. A spinning tire with a loose tread must be stopped prior to entering the wheel well or it can cause damage to wheel well components. When a spinning tire with loose tread impacts a fitting in the wheel well ring opening, that gear stops retracting and free falls back to the down position. The affected gear cannot be retracted until the fitting is replaced.

Landing Gear Transfer Unit

Hydraulic system B pressure is available for raising the landing gear through the landing gear transfer unit. Hydraulic system B supplies the volume of hydraulic fluid required to raise the landing gear at the normal rate when all of the following conditions exist:

- airborne
- No. 1 engine RPM drops below a limit value
- LANDING GEAR lever is positioned UP
- either main landing gear is not up and locked.

Landing Gear Extension

When the LANDING GEAR lever is moved to DN, hydraulic system A pressure is used to release the uplocks. The landing gear extends by hydraulic pressure, gravity and air loads. Overcenter mechanical and hydraulic locks hold the gear at full extension. The nose wheel doors remain open when the gear is down.

Landing Gear Manual Extension

If hydraulic system A pressure is lost, the manual extension system provides another means of landing gear extension. Manual gear releases on the flight deck are used to release uplocks that allow the gear to free-fall to the down and locked position. The forces that pull the gear down are gravity and air loads.

With the manual extension access door open:

- manual landing gear extension is possible with the LANDING GEAR lever in any position
- normal landing gear extension is possible if hydraulic system A pressure is available
- landing gear retraction is disabled.

Following a manual extension, the landing gear may be retracted normally by accomplishing the following steps:

- close the manual extension access door
- move the LANDING GEAR lever to DOWN with hydraulic system A pressure available, and then
- position the LANDING GEAR lever to UP.

Nose Wheel Steering

The airplane is equipped with nose wheel steering which is powered by hydraulic system A when the NOSE WHEEL STEERING switch is in the NORM position. Nose wheel steering is powered by hydraulic system B when the NOSE WHEEL STEERING switch is placed to ALT. Nose wheel steering is powered only when the airplane is on the ground. In the event of a hydraulic leak downstream of the Landing Gear Transfer Unit, resulting in a loss of hydraulic system B fluid in the reservoir, a sensor closes the Landing Gear Transfer Valve and alternate steering will be lost.

Primary steering is controlled through the nose wheel steering wheel. Limited steering control is available through the rudder pedals. A pointer on the nose steering wheel assembly shows nose wheel steering position relative to the neutral setting. Rudder pedal steering is deactivated as the nose gear strut extends.

A lockout pin may be installed in the towing lever to depressurize nose wheel steering. This allows airplane pushback or towing without depressurizing the hydraulic systems.

Brake System

Each main gear wheel has a multi-disc hydraulic powered brake. The brake pedals provide independent control of the left and right brakes. The nose wheels have no brakes. The brake system includes:

- normal brake system
- alternate brake system
- brake accumulator
- antiskid protection
- autobrake system
- parking brake

Normal Brake System

The normal brake system is powered by hydraulic system B.

Alternate Brake System

The alternate brake system is powered by hydraulic system A. If hydraulic system B is low or fails, hydraulic system A automatically supplies pressure to the alternate brake system.

Brake Accumulator

The brake accumulator is pressurized by hydraulic system B. If both normal and alternate brake system pressure is lost, trapped hydraulic pressure in the brake accumulator can still provide several braking applications or parking brake application.

Antiskid Protection

Antiskid protection is provided in the normal and alternate brake systems.

The normal brake hydraulic system provides each main gear wheel with individual antiskid protection. When the system detects a skid, the associated antiskid valve reduces brake pressure until skidding stops. The alternate brake hydraulic system works similar to the normal system however antiskid protection is applied to main gear wheel pairs instead of individual wheels.

Both normal and alternate brake systems provide skid, locked wheel, touchdown and hydroplane protection.

Antiskid protection is available even with loss of both hydraulic systems.

Autobrake System

The autobrake system uses hydraulic system B pressure to provide maximum deceleration for rejected takeoff and automatic braking at preselected deceleration rates immediately after touchdown. The system operates only when the normal brake system is functioning. Antiskid system protection is provided during autobrake operation.

Rejected Takeoff (RTO)

The RTO mode can be selected only when on the ground. Upon selection, the AUTO BRAKE DISARM light illuminates for one to two seconds and then extinguishes, indicating that an automatic self-test has been successfully accomplished.

To arm the RTO mode prior to takeoff the following conditions must exist:

- airplane on the ground
- antiskid and autobrake systems operational
- AUTO BRAKE select switch positioned to RTO
- wheel speed less than 60 knots
- forward thrust levers positioned to IDLE.

With RTO selected, if the takeoff is rejected prior to wheel speed reaching 90 knots autobraking is not initiated, the AUTO BRAKE DISARM light does not illuminate and the RTO autobrake function remains armed. If the takeoff is rejected after reaching a wheel speed of 90 knots, maximum braking is applied automatically when the forward thrust levers are retarded to IDLE.

737 Flight Crew Operations Manual

The RTO mode is automatically disarmed when both air/ground systems indicate the air mode. The AUTO BRAKE DISARM light does not illuminate and the AUTO BRAKE select switch remains in the RTO position. To reset or manually disarm the autobrake system, position the selector to OFF. If a landing is made with RTO selected (AUTO BRAKE select switch not cycled through OFF), no automatic braking action occurs and the AUTO BRAKE DISARM light illuminates two seconds after touchdown.

Landing

When a landing autobrake selection is made, the system performs a turn-on-self-test. If the turn-on-self-test is not successful, the AUTO BRAKE DISARM light illuminates and the autobrake system does not arm.

Four levels of deceleration can be selected for landing. However, on dry runways, the maximum autobrake deceleration rate in the landing mode is less than that produced by full pedal braking.

After landing, autobrake application begins when:

- both forward thrust levers are retarded to IDLE
- the main wheels spin-up.

Note: Landing autobrake settings may be selected after touchdown prior to decelerating through 60 kts of ground speed. Braking initiates immediately if the above conditions are met.

To maintain the selected landing deceleration rate, autobrake pressure is reduced as other controls, such as thrust reversers and spoilers, contribute to total deceleration. The deceleration level can be changed (without disarming the system) by rotating the selector. The autobrake system brings the airplane to a complete stop unless the braking is terminated by the pilot.

Autobrake – Disarm

The pilots may disarm the autobrake system by moving the selector switch to the OFF position. This action does not cause the AUTO BRAKE DISARM light to illuminate. After braking has started, any of the following pilot actions disarm the system immediately and illuminate the AUTO BRAKE DISARM light:

- moving the SPEED BRAKE lever to the down detent
- advancing the forward thrust lever(s), except during the first 3 seconds after touchdown for landing
- applying manual brakes.

Parking Brake

The parking brake can be set with either A or B hydraulic systems pressurized. If A and B hydraulic systems are not pressurized, parking brake pressure is maintained by the brake accumulator. Accumulator pressure is shown on the HYD BRAKE PRESS indicator.

The parking brake is set by depressing both brake pedals fully, while simultaneously pulling the PARKING BRAKE lever up. This mechanically latches the pedals in the depressed position and commands the parking brake valve to close.

The parking brake is released by depressing the pedals until the PARKING BRAKE lever releases. A fault in the parking brake system may cause the ANTISKID INOP light to illuminate.

The takeoff configuration warning horn sounds if either forward thrust lever is advanced for takeoff with the parking brake set.

Air/Ground System

In flight and ground operation of various airplane systems are controlled by the air/ground system.

The system receives air/ground logic signals from six sensors, two on each landing gear. These signals are used to configure the airplane systems to the appropriate air or ground status.

Air/Ground System Logic Table

SYSTEMS	NORMAL INFLIGHT OPERATION	NORMAL ON GROUND OPERATION	REFER TO CH
Emergency Exit Doors	Flight locks engaged when either engine N2 is more than 50% and 3 or more Entry/Service doors are closed.	Flight locks disengaged when either thrust lever is set below approximately 53 degrees.	1
Pack Valves	With one pack operating, regulates to high flow with flaps up.	With one pack operating, regulates to high flow only when pack is operating from the APU and both engine bleed switches are OFF.	2
Pressurization	Allows programmed pressurization in the automatic modes.	Allows pressurization only at high power settings.	2

737 Flight Crew Operations Manual

SYSTEMS	NORMAL INFLIGHT OPERATION	NORMAL ON GROUND OPERATION	REFER TO CH
Ram Air	Ram Air fans operate whenever air conditioning packs operate.	Ram Air fans operate whenever air conditioning packs operate. Deflectors are extended.	2
Wing Anti-ice	Control valves open when switch is ON. Thrust setting and duct temperature logic is bypassed.	With switch ON, valves cycle open and closed. Switch trips to OFF at lift-off.	3
Autothrottle	Enables go-around below 2000 ft radio altitude.	Disengaged 2 seconds after landing. Takeoff mode enabled.	4
TO/GA switch	Flight director engages go-around mode.	Flight director engages takeoff mode.	4
ACARS	Sends out signal on strut extension for takeoff signal.	Sends out signal on strut compression for landing signal.	5
Voice Recorder	Prevents tape erasure.	Allows tape erasure when parking brake is set.	5
Engine Idle Control	Enables minimum flight idle.	Enables minimum ground idle.	7
Thrust Reverser	Thrust reverse disabled.	Thrust reverse enabled.	7
APU Fire Horn	Wheel well horn disabled.	Wheel well horn enabled.	8
Cargo Fire Protection	Second extinguishing bottle timer enabled.	Second extinguishing bottle timer disabled.	8
Speed Brake Lever Actuator	Can be armed to raise ground spoilers for landing.	Activates SPEED BRAKE lever on landing if armed. Rejected take-off feature available. Drives to DOWN when thrust lever advanced.	9
Auto Slat	System enabled with flaps 1, 2, or 5 selected. PTU available if system B pressure is lost.	System disabled.	9

SYSTEMS	NORMAL INFLIGHT OPERATION	NORMAL ON GROUND OPERATION	REFER TO CH
Flight Recorder	Operates anytime electrical power is available.	Operates anytime electrical power is available and either engine is operating.	10
FMC	FMC position updated from GPS, DME or VOR/DME.	FMC position updated from GPS.	11
Standby Hydraulic	Pump automatic operation with flaps extended and A or B pressure lost.	Wheel speed must be greater than 60 knots for automatic operation.	13
Antiskid	Releases normal or alternate brakes for touchdown protection.	Allows normal antiskid braking after wheel spin-up.	14
Autobrakes	Allows selection of landing mode.	RTO mode available and landing mode may be selected after touchdown if wheel speed is greater than 60 knots.	14
Landing Gear Lever Lock	Lever lock solenoid released.	Lever lock solenoid latched.	14
Landing Gear Transfer Unit	Enabled.	Disabled.	14
Stall Warning	Enabled.	Disabled.	15
Takeoff Warning	Disabled.	Enabled.	15



Controls and Indicators **15.10.1**

 Fire Warning and Master Caution System 15.10.1

 Proximity Switch Electronic Unit Light 15.10.2

 Mach/Airspeed Warning and Stall Warning Test
 Switches 15.10.3

 Landing Gear Warning Cutout Switch 15.10.4

 Altitude Alert 15.10.4

 Ground Proximity Warning System (GPWS) 15.10.6

 GPWS Controls 15.10.6

 Terrain Display 15.10.8

 Terrain Display 15.10.10

 Predictive Windshear Display and Annunciations 15.10.11

 Predictive Windshear Display and Annunciations 15.10.12

 TCAS Controls (Transponder Panel) 15.10.13

System Description **15.20.1**

 Introduction 15.20.1

 Master Fire Warning Lights 15.20.2

 Master Caution Lights 15.20.2

 System Annunciator Lights 15.20.3

 Warning Systems 15.20.5

 Takeoff Configuration Warning 15.20.5

 Landing Gear Configuration Warnings 15.20.6

 Proximity Switch Electronic Unit (PSEU) 15.20.7

 Mach/Airspeed Warning System 15.20.7

 Stall Warning System 15.20.7

 Altitude Alerting System 15.20.8

 Acquisition Alerting 15.20.8

 Deviation Alerting 15.20.9

 Altitude Alert Profile 15.20.9

Altitude Alerting System	15.20.9
Acquisition Alerting	15.20.10
Deviation Alerting	15.20.10
Altitude Alert Profile	15.20.10
Altitude Alerting System	15.20.10
Acquisition Alerting	15.20.11
Deviation Alerting	15.20.11
Altitude Alert Profile	15.20.11
Ground Proximity Alerts	15.20.11
Look-Ahead Terrain Alerting	15.20.12
Radio Altitude Based Alerts	15.20.13
Windshear Alerts	15.20.14
Windshear Warning (Airplane in Windshear)	15.20.15
Predictive Windshear Alerts	15.20.15
Bank Angle Alert	15.20.17
Approach Callouts	15.20.17
Radio Altitude Callouts	15.20.17
Radio Altitude Callouts	15.20.18
500 Foot Radio Altitude Callout	15.20.18
DH/MDA Callouts	15.20.18
DH/MDA Callouts	15.20.18
Traffic Alert and Collision Avoidance System (TCAS)	15.20.19
Advisories and Displays	15.20.19
Inhibits	15.20.20
Mode Control	15.20.20
Resolution Advisory Aural	15.20.21
Tail Skid	15.20.21
Tail Skid Detail	15.20.22

Fire Warning and Master Caution System

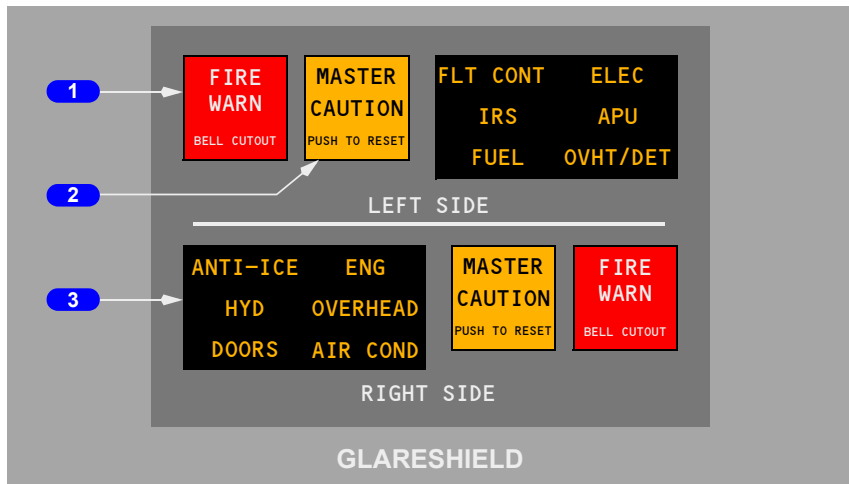

1 Master Fire Warning (FIRE WARN) Lights

Illuminated (red) – indicates a fire warning (or system test) in engine, cargo, APU or main gear wheel well

- fire warning bell sounds
- if on ground, remote APU fire warning horn sounds.

Push –

- extinguishes both master FIRE WARN lights
- silences fire warning bell
- silences remote APU fire warning horn
- resets system for additional warnings.

Note: Pushing fire warning bell cutout switch on overhead/fire protection panel results in same actions.

2 MASTER CAUTION Lights

Illuminated (amber) – a system annunciator light has illuminated.

Push – extinguishes both MASTER CAUTION lights

- system annunciator light(s) extinguish
- resets system for additional master caution conditions.

3 System Annunciator Panel

Illuminated (amber) – an amber light, relating to illuminated system annunciator, has illuminated on forward overhead, aft overhead or overhead/fire protection panel.

To extinguish – push either MASTER CAUTION light.

To recall – push and release either system annunciator panel

- if a master caution condition exists, appropriate system annunciator(s) and MASTER CAUTION lights illuminate
- a single fault in certain redundant systems, or some simple faults, cause the system annunciator light to illuminate during a recall. The system annunciator light will extinguish when the MASTER CAUTION light is pushed.

Proximity Switch Electronic Unit Light

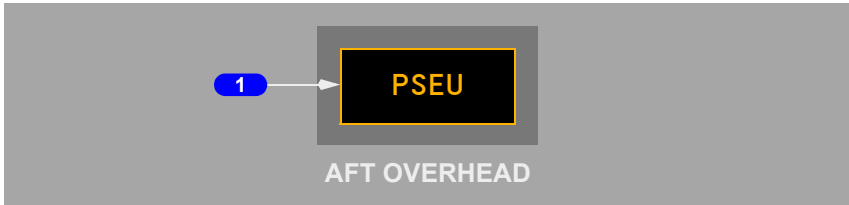

1 Proximity Switch Electronic Unit (PSEU) Light

Illuminated (amber) –

- on the ground –
 - a fault is detected in the PSEU, or
 - an overwing exit flight lock fails to disengage when commanded.
- in-flight –
 - inhibited from thrust lever advance for takeoff until 30 seconds after landing.

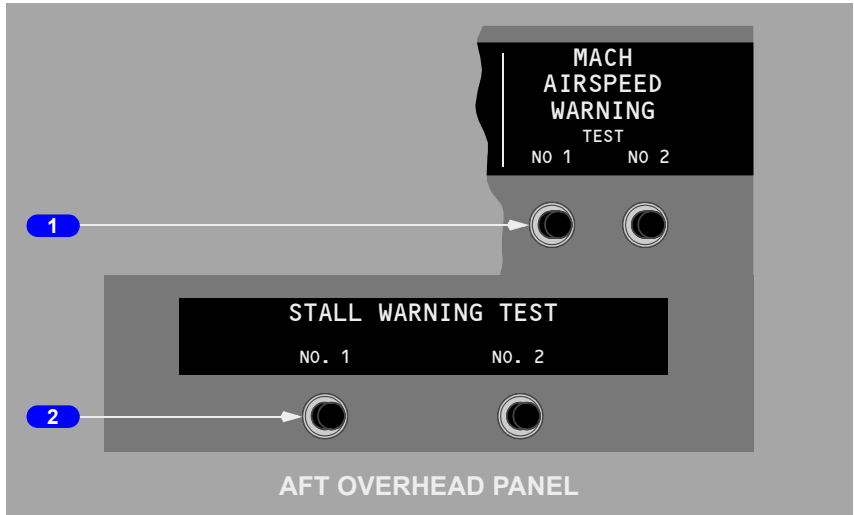
Mach/Airspeed Warning and Stall Warning Test Switches

1 MACH AIRSPEED WARNING TEST Switches

Push – tests respective mach/airspeed warning system

- clacker sounds
- inhibited while airborne.

2 STALL WARNING TEST Switches

Push – on ground with AC power available: each test switch tests its respective stall management yaw damper (SMYD) computer. No.1 SMYD computer shakes Captain's control column, No.2 SMYD computer shakes First Officer's control column. Vibrations can be felt on both columns

- inhibited while airborne.

Landing Gear Warning Cutout Switch

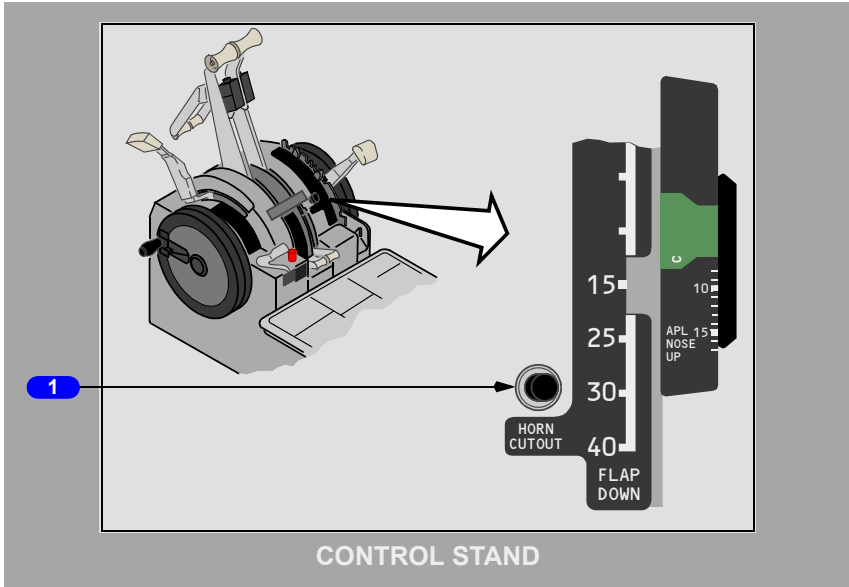

1 Landing Gear Warning Cutout Switch

Push – silences landing gear configuration warning aural indication at flaps up through 10 and above 200 feet RA.

Note: The aural indication cannot be silenced with the cutout switch at flaps greater than 10.

Altitude Alert

YA371, YA372, YC201

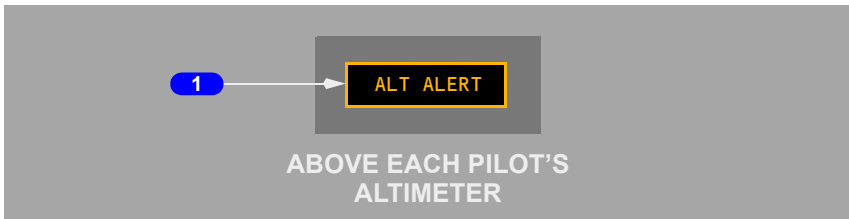

1 Altitude Alert (ALT ALERT) Annunciation

One on each pilot's primary display above altimeter.

737 Flight Crew Operations Manual

Displayed (amber):

- steady – acquisition alert:
 - 750 feet from MCP selected altitude
 - 200 feet from MCP selected altitude, ALT ALERT annunciation no longer shows.
- flashing – deviation alert:
 - deviation more than 200 feet from MCP selected altitude
 - momentary tone also sounds
 - flashing continues until:
 - altitude deviation less than 200 feet, or
 - new MCP altitude selected.

YA373 - YA377, YC202 - YE326

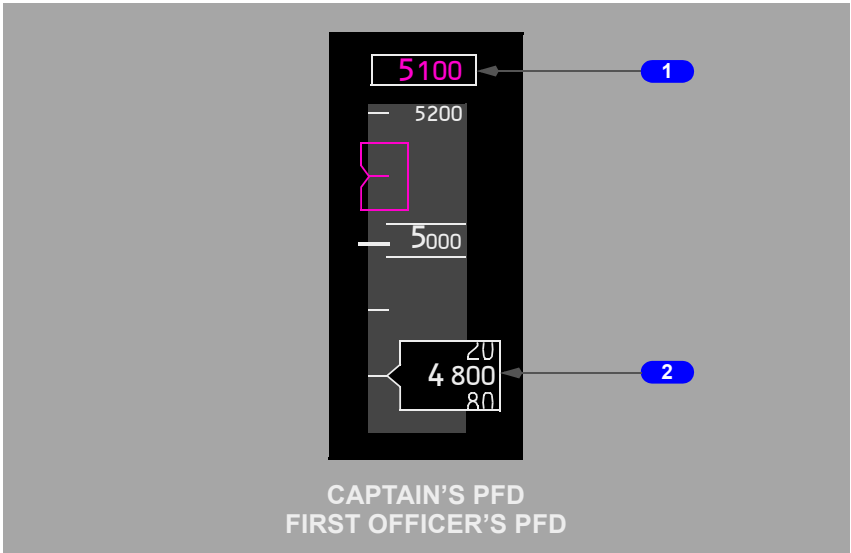

1 Selected Altitude Alert

YA373 - YA377, YC202 - YC207, YE324 - YE326

A white box shows around the selected altitude display between 900 feet and 200 feet before reaching the selected altitude.

1 Selected Altitude Alert

YE321 - YE323

A white box shows around the selected altitude display between 750 feet and 200 feet before reaching the selected altitude.

2 Current Altitude Alert

YA373 - YA377, YC202 - YC207, YE324 - YE326

The white box around the current altitude display becomes bold between 900 feet and 200 feet before reaching the selected altitude.

The box turns amber and flashes for 200 feet to 900 feet deviation from the selected altitude.

2 Current Altitude Alert

YE321 - YE323

The white box around the selected altitude display becomes bold between 750 feet and 200 feet before reaching the selected altitude.

The box turns amber and flashes for deviations greater than 200 feet from the selected altitude.

Ground Proximity Warning System (GPWS)

GPWS Controls

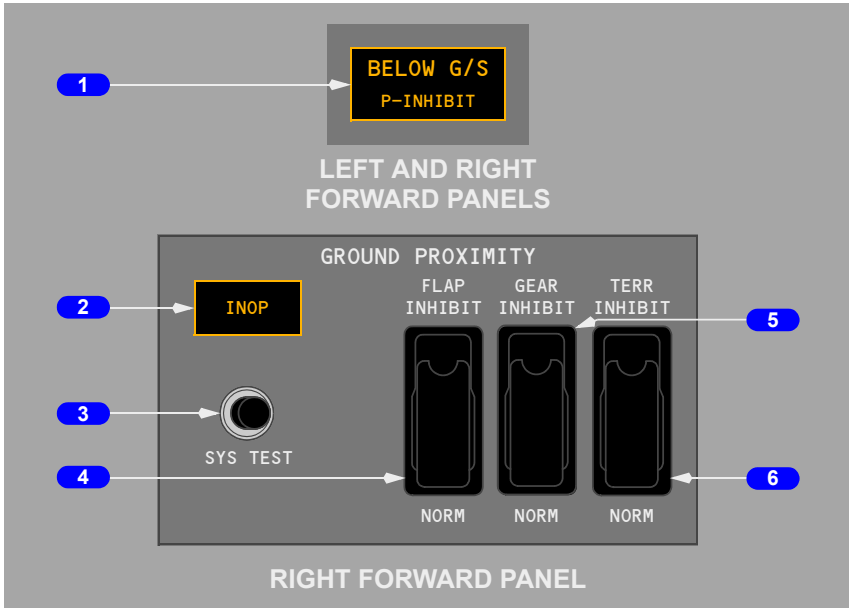

1 BELOW Glide Slope (G/S) light

Illuminated (amber) – below glide slope alert is active.

737 Flight Crew Operations Manual

Push – inhibits ground proximity GLIDE SLOPE alert when below 1,000 feet radio altitude.

2 Inoperative (INOP) light

Illuminated (amber) – GPWS computer malfunction or power loss

- invalid inputs are being received from radio altimeter, ADIRU, ILS receiver, IRS, FMC, stall management computers, or EFIS control panel.

3 Ground Proximity System Test (SYS TEST) Switch

Push –

- momentarily on ground:
 - BELOW G/S and GPWS INOP lights illuminate
 - TERR FAIL and TERR TEST show on navigation displays
 - PULL UP and WINDSHEAR alerts illuminate
 - GLIDE SLOPE, PULL UP, and WINDSHEAR aural sound
 - terrain display test pattern shows on navigation displays
 - terrain caution aural sounds and TERRAIN caution message shows on navigation displays.
- until self-test aural begin, on ground, above indications always occur first, followed by these additional aural, as described in section 15-20:
 - radio altitude based alerts
 - bank angle alert
 - approach callouts
 - windshear alert
 - look ahead terrain alerts
- system test inhibited in-flight.

4 Ground Proximity FLAP INHIBIT Switch

FLAP INHIBIT – inhibits ground proximity TOO LOW FLAPS alert.

NORM (guarded position) – Normal TOO LOW FLAPS alert active.

5 Ground Proximity GEAR INHIBIT Switch

GEAR INHIBIT – inhibits ground proximity TOO LOW GEAR alert.

NORM (guarded position) – Normal TOO LOW GEAR alert active.

6 Ground Proximity Terrain Inhibit (TERR INHIBIT) Switch

TERR INHIBIT – inhibits look-ahead terrain alerts and terrain display.

NORM (guarded position) – Normal terrain alerts and terrain display active.

GPWS Terrain Display Select Switch

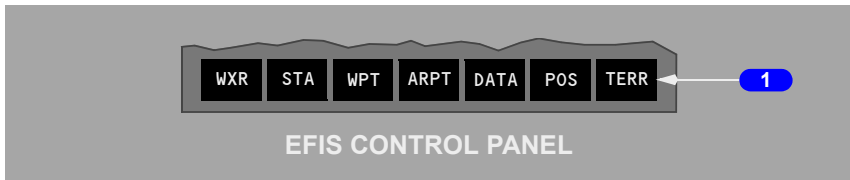

1 Terrain (TERR) Display Select Switch

Push –

- shows terrain data in expanded MAP, center MAP, expanded VOR, and expanded APP modes
- arms terrain data in PLN, center VOR, and center APP modes
- deselects weather radar display regardless of mode selector position
- second push deselects terrain display.

Terrain Display

YA373 - YA377, YC202 - YE326

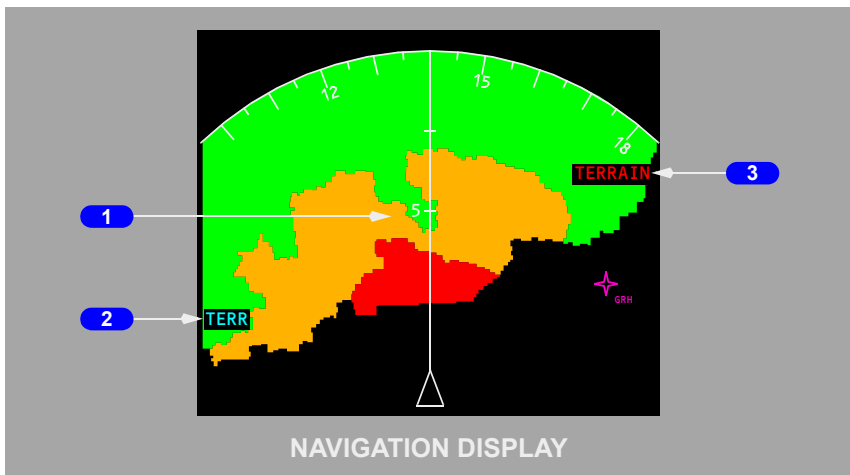

1 Terrain Display

Color and density vary based on terrain height vs. airplane altitude:

- dotted green: terrain from 2,000 feet below to 500 feet (250 feet with gear down) below the airplane's current altitude
- dotted amber: terrain 500 feet (250 feet with gear down) below to 2,000 feet above the airplane's current altitude
- dotted red: terrain more than 2,000 feet above airplane's current altitude
- dotted magenta: no terrain data available

737 Flight Crew Operations Manual

- solid amber: look-ahead terrain caution active
- solid red: look-ahead terrain warning active.

Note: In areas without terrain data, look-ahead terrain alerting and display functions not available. Radio altitude based terrain alerts function normally.

Note: Terrain more than 2,000 feet below airplane altitude or within 400 feet of nearest airport runway elevation does not show.

Automatically shows when:

- a look-ahead terrain alert occurs, and
- neither pilot has the terrain display selected, and
- in expanded MAP, center MAP, expanded VOR, or expanded APP modes.

Updates with a display sweep, similar to weather radar display.

2 Terrain Mode Annunciation

TERR (cyan) – Terrain display enabled (manual or automatic display).

3 TERRAIN Annunciation

TERRAIN (amber) – look-ahead terrain caution alert active.

TERRAIN (red) – look-ahead terrain warning alert active.

Shows in all navigation display modes.

Terrain Display

YA371, YA372, YC201

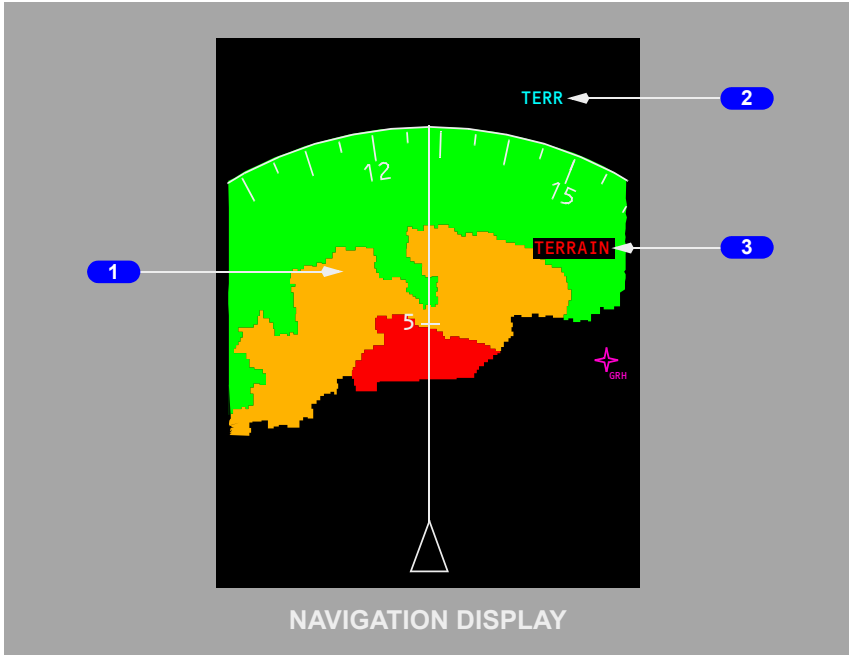

1 Terrain Display

Color and density vary based on terrain height vs. airplane altitude:

- dotted green: terrain from 2,000 feet below to 500 feet (250 feet with gear down) below the airplane's current altitude
- dotted amber: terrain 500 feet (250 feet with gear down) below to 2,000 feet above the airplane's current altitude
- dotted red: terrain more than 2,000 feet above airplane's current altitude
- dotted magenta: no terrain data available
- solid amber: look-ahead terrain caution active
- solid red: look-ahead terrain warning active.

Note: In areas without terrain data, look-ahead terrain alerting and display functions not available. Radio altitude based terrain alerts function normally.

Note: Terrain more than 2,000 feet below airplane altitude or within 400 feet of nearest airport runway elevation does not show.

737 Flight Crew Operations Manual

Automatically shows when:

- a look-ahead terrain alert occurs, and
- neither pilot has the terrain display selected, and
- in expanded MAP, center MAP, expanded VOR, or expanded APP modes.

Updates with a display sweep, similar to weather radar display.

2 Terrain Mode Annunciation

TERR (cyan) – Terrain display enabled (manual or automatic display).

3 TERRAIN Annunciation

TERRAIN (amber) – look-ahead terrain caution alert active.

TERRAIN (red) – look-ahead terrain warning alert active.

Shows in all navigation display modes.

Predictive Windshear Display and Annunciations

YA373 - YA377, YC202 - YE326

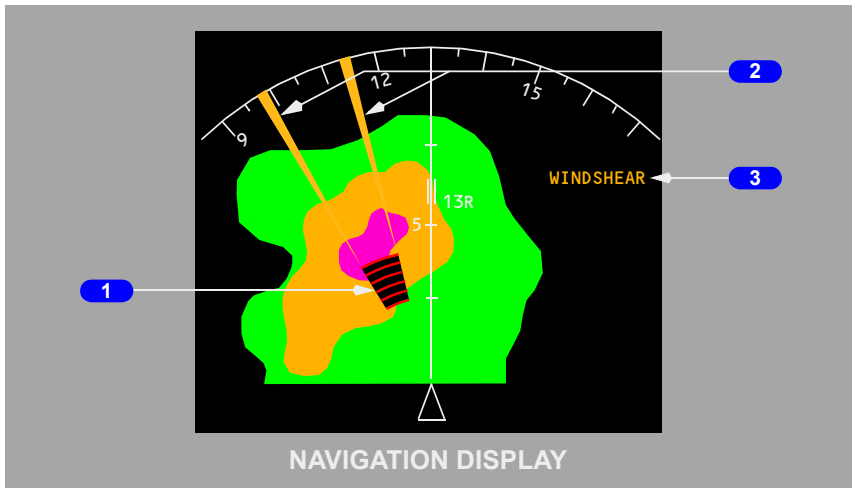

1 Predictive Windshear Symbol

Displayed (red and black) – Predictive windshear alert active.

Shows windshear location and approximate geometric size (width and depth).

Symbol, radials, and weather radar returns automatically show when:

- predictive windshear alert occurs, and
- neither pilot has WXR display selected, and
- in expanded MAP, center MAP, VOR, or APP modes.

737 Flight Crew Operations Manual

1 Predictive Windshear Symbol

Displayed (red and black) – Predictive windshear alert active.

Shows windshear location and approximate geometric size (width and depth).

Symbol, radials, and weather radar returns automatically show when:

- predictive windshear alert occurs, and
- neither pilot has WXR display selected, and
- in expanded MAP, center MAP, VOR, or APP modes.

When terrain display is active, weather radar display replaces terrain display.

2 Predictive Windshear Symbol Radials

Displayed (amber) – Predictive windshear alert active.

Extend from predictive windshear symbol to help identify location of windshear event.

3 WINDSHEAR Annunciation

WINDSHEAR (amber) – predictive windshear caution active.

WINDSHEAR (red) – predictive windshear warning active.

Shows in all navigation display modes.

TCAS Controls (Transponder Panel)



1 Transponder Mode Selector

TA (traffic advisory) ONLY – enables the display of traffic advisory (TA) targets.

TA/RA (resolution advisory) – enables the display of traffic advisory (TA) and resolution advisory (RA) targets.



Intentionally
Blank



Introduction

Aural, tactile and visual warning signals alert the flight crew to conditions requiring action or caution in the operation of the airplane. The character of the signals varies, depending upon the degree of urgency or hazards involved. Aural, tactile, and visual signals are used singularly or in combination to simultaneously provide both warnings and information regarding the nature of the condition.

Mach/airspeed warnings, landing gear warnings, takeoff configuration warnings, windshear warnings, and ground proximity warnings are discussed in this section. Cabin altitude warning is discussed in the Air Systems chapter, and autopilot and autothrottle disconnect warnings are discussed in the Automatic Flight chapter. The conditions which excite the fire warning bell are discussed in the Fire Protection chapter.

Conditions which require the immediate attention of the flight crew are indicated by red warning lights located in the area of the pilots' primary field of vision. These lights indicate engine, wheel well, cargo, or APU fires; autopilot, autothrottle disconnects; and landing gear unsafe conditions.

Conditions which require the timely attention of the flight crew are indicated by amber caution lights.

Blue lights inform the flight crew of electrical power availability, valve position, equipment status, and flight attendant or ground communications. Blue lights are for information and do not require immediate flight crew attention. Some system blue lights indicate a transitional state by illuminating bright as valves or components reposition, then returning to a dim blue when the required configuration is reached.

Green lights indicate a fully extended configuration, e.g., landing gear and leading edge devices.

For specific information regarding red, amber, blue, and green lights refer to the appropriate systems chapters.

Stall warning is provided by a control column shaker on each control column.

Various aural signals call attention to warnings and cautions. An aural warning for airspeed limits is given by a clacker, the autopilot disconnect by a warning tone, cabin altitude by an intermittent horn, and landing gear positions by a steady horn. The takeoff configuration is given by an intermittent horn, and the fire warning by a fire warning bell. Ground proximity warnings and alerts, and windshear warnings and alerts are given by voice warnings.

Generally, aural warnings automatically silence when the associated non-normal condition no longer exists.

Master Fire Warning Lights

Two master FIRE WARN lights illuminate when any fire warning condition occurs. The lights remain illuminated as long as the condition exists. Pushing either master FIRE WARN light or fire warning bell cutout switch extinguishes both lights, silences the fire warning bell and resets the system for future warnings. Further information appears in the Fire Protection chapter.

Master Caution Lights

Two MASTER CAUTION lights illuminate when any caution occurs outside the normal field of vision of the flight crew. The lights remain illuminated as long as the caution condition exists, or until the crew resets the system. Pushing either MASTER CAUTION light extinguishes both lights and resets the master caution system for further cautions. Pushing either annunciator light panel recalls all existing fault annunciations.

A single fault in certain redundant systems, or some simple faults, do not illuminate the MASTER CAUTION or system annunciator lights. These faults, however, are stored in the master caution system. Pushing the system annunciator recalls the single fault on the system annunciator panel.

When the MASTER CAUTION recall is pressed, all twelve system lights should illuminate while the press-to-test feature is held. If a system annunciator light does not illuminate, refer to the dispatch deviation procedures guide (DDPG).

737 Flight Crew Operations Manual
System Annunciator Lights

Two system annunciator light panels are located on the glare shield. The annunciator light panels include only those systems located on the forward overhead, aft overhead, and fire control panels. If a caution condition exists, the appropriate system annunciator(s) and MASTER CAUTION lights illuminate.

System Annunciators and Related Amber Lights – Left Side

FLT CONT	<table border="1"> <tbody> <tr> <td>FLT CONT</td> <td>ELEC</td> </tr> <tr> <td>IRS</td> <td>APU</td> </tr> <tr> <td>FUEL</td> <td>OVHT/DET</td> </tr> </tbody> </table>	FLT CONT	ELEC	IRS	APU	FUEL	OVHT/DET	ELEC
FLT CONT		ELEC						
IRS		APU						
FUEL		OVHT/DET						
LOW QUANTITY			DRIVE					
LOW PRESSURE			STANDBY PWR OFF					
FEEL DIFF PRESS			TRANSFER BUS OFF					
SPEED TRIM FAIL			SOURCE OFF					
MACH TRIM FAIL		TR UNIT						
AUTO SLAT FAIL		BATTERY DISCHARGE						
YAW DAMPER		ELEC						
YA372 - YE326								
STBY RUD ON								
IRS	LEFT SIDE GLARESHIELD	APU						
FAULT		LOW OIL PRESSURE						
ON DC		FAULT						
DC FAIL		OVERSPEED						
GPS								
FUEL		OVHT/DET						
LOW PRESSURE		ENGINE 1 OVERHEAT						
FILTER BYPASS		ENGINE 2 OVERHEAT						
		APU DET INOP						

System Annunciators and Related Amber Lights – Right Side

YA371 - YA377, YE321 - YE326

ANTI-ICE	<table border="1" style="margin: auto;"> <tr> <td style="background-color: black; color: yellow;">ANTI-ICE</td> <td style="background-color: black; color: yellow;">ENG</td> </tr> <tr> <td style="background-color: black; color: yellow;">HYD</td> <td style="background-color: black; color: yellow;">OVERHEAD</td> </tr> <tr> <td style="background-color: black; color: yellow;">DOORS</td> <td style="background-color: black; color: yellow;">AIR COND</td> </tr> </table> <p>RIGHT SIDE GLARESHIELD</p>	ANTI-ICE	ENG	HYD	OVERHEAD	DOORS	AIR COND	ENG
ANTI-ICE		ENG						
HYD		OVERHEAD						
DOORS		AIR COND						
WINDOW OVERHEAT PITOT HEAT COWL ANTI-ICE		REVERSER EEC ALTN MODE ENGINE CONTROL						
HYD		OVERHEAD						
OVERHEAT LOW PRESSURE	EQUIP COOLING– OFF EMER EXIT LIGHTS–NOT ARMED FLIGHT RECORDER–OFF PASS OXY–ON PSEU ELT							
DOORS	AIR COND							
FWD/AFT ENTRY EQUIP FWD/AFT CARGO FWD/AFT SERVICE LEFT/RIGHT OVERWING	DUAL BLEED WING–BODY OVERHEAT BLEED TRIP OFF AUTO FAIL OFF SCHED DESCENT DUCT OVERHEAT PACK TRIP OFF							

737 Flight Crew Operations Manual

YC201 - YC207

ANTI-ICE	<table border="1" style="margin: auto;"> <tr> <td style="text-align: center;">ANTI-ICE</td> <td style="text-align: center;">ENG</td> </tr> <tr> <td style="text-align: center;">HYD</td> <td style="text-align: center;">OVERHEAD</td> </tr> <tr> <td style="text-align: center;">DOORS</td> <td style="text-align: center;">AIR COND</td> </tr> </table> <p>RIGHT SIDE GLARESHIELD</p>	ANTI-ICE	ENG	HYD	OVERHEAD	DOORS	AIR COND	ENG
ANTI-ICE		ENG						
HYD		OVERHEAD						
DOORS		AIR COND						
WINDOW OVERHEAT PITOT HEAT COWL ANTI-ICE		REVERSER EEC ALTN MODE ENGINE CONTROL						
HYD		OVERHEAD						
OVERHEAT LOW PRESSURE	EQUIP COOLING- OFF EMER EXIT LIGHTS-NOT ARMED FLIGHT RECORDER-OFF PASS OXY-ON PSEU ELT							
DOORS	AIR COND							
FWD/AFT ENTRY EQUIP FWD/AFT CARGO FWD/AFT SERVICE LEFT/RIGHT OVERWING	DUAL BLEED WING-BODY OVERHEAT BLEED TRIP OFF AUTO FAIL OFF SCHED DESCENT ZONE TEMP PACK							

Warning Systems

Takeoff Configuration Warning

The takeoff configuration warning is armed when the airplane is on the ground and either or both forward thrust levers are advanced for takeoff. An intermittent takeoff warning horn sounds if:

- trailing edge flaps are not in the flaps 1 through 25 takeoff range, or
- leading edge devices not configured for takeoff, or
- SPEED BRAKE lever is not in the DOWN position, or
- spoilers not down with the speedbrake lever in the DOWN position, or
- parking brake is set, or
- stabilizer trim not set in the takeoff range.

The warning indication is cancelled when the configuration error is corrected.

Landing Gear Configuration Warnings

Visual indications and aural warnings of landing gear position are provided by the landing gear indicator lights and landing gear warning horn.

Visual Indications

The landing gear indication lights are activated by signals from each gear, the LANDING GEAR lever, and the forward thrust lever position as follows:

Green light illuminated – landing gear is down and locked.

Red light illuminated –

- landing gear is in disagreement with LANDING GEAR lever position (in transit or unsafe).
- landing gear is not down and locked (with either or both forward thrust levers retarded to idle, and below 800 feet AGL).

All lights extinguished – landing gear is up and locked with the LANDING GEAR lever UP or OFF.

Aural Indications

A steady warning horn is provided to alert the flight crew whenever a landing is attempted and any gear is not down and locked. The landing gear warning horn is activated by forward thrust lever and flap position as follows:

Flaps up through 10 –

- altitude below 800 feet RA, when either forward thrust lever set between idle and approximately 20 degrees thrust lever angle or an engine not operating and the other thrust lever less than 34 degrees. The landing gear warning horn can be silenced (reset) with the landing gear warning HORN CUTOUT switch
- if the airplane descends below 200 feet RA, the warning horn cannot be silenced by the warning HORN CUTOUT switch.

Flaps 15 through 25 –

- either forward thrust lever set below approximately 20 degrees or an engine not running, and the other thrust lever less than 34 degrees; the landing gear warning horn cannot be silenced with the landing gear warning HORN CUTOUT switch.

Flaps greater than 25 –

- regardless of forward thrust lever position; the landing gear warning horn cannot be silenced with the landing gear warning HORN CUTOUT switch.

The warning indication is cancelled when the configuration error is corrected.

Proximity Switch Electronic Unit (PSEU)

The PSEU monitors the following systems:

- takeoff configuration warnings
- landing configurations warnings
- landing gear
- air/ground sensing.

The PSEU, its sensors, and its input signals are monitored for internal faults. When designated faults are detected, a PSEU light on the aft overhead panel illuminates, and the OVERHEAD system annunciator light and MASTER CAUTION lights illuminate. The PSEU light can be reset following a maintenance BITE check or repair of the cause of the fault.

The PSEU light and OVERHEAD system annunciator do not illuminate for simple faults unless a system annunciator panel is pushed for recall. In this case, a simple fault, resetting the MASTER CAUTION system extinguishes the PSEU light.

The PSEU light is inhibited:

- in flight
- when the thrust levers are advanced toward takeoff power
- for 30 seconds after landing.

Mach/Airspeed Warning System

Two independent Mach/airspeed warning systems provide a distinct aural warning, a clacker, any time the maximum operating airspeed of V_{mo}/M_{mo} is exceeded. The warning clackers can be silenced only by reducing airspeed below V_{mo}/M_{mo} .

The airspeed indicator displays red warning bands indicating maximum and minimum airspeeds. Amber bands indicate maximum and minimum maneuvering airspeeds.

When either an overspeed condition or a system test occurs, the ADIRU transmits a signal to the aural warning module, sounding the clacker. The system can only be tested on the ground.

Stall Warning System

Natural stall warning (buffet) usually occurs at a speed prior to stall. In some configurations the margin between stall and natural stall warning is less than desired. Therefore, an artificial stall warning device, a stick shaker, is used to provide the required warning.

The stall warning “stick shaker” consists of two eccentric weight motors, one on each control column. They are designed to alert the pilots before a stall develops. The warning is given by vibrating both control columns. The system is armed in flight at all times. The system is deactivated on the ground.

Two independent, identical stall management yaw damper (SMYD) computers determine when stall warning is required based upon:

- alpha vane angle of attack outputs
- ADIRU outputs
- anti-ice controls
- wing configurations
- air/ground sensing
- thrust
- FMC outputs.
- mach compensation

The SMYD computers provide outputs for all stall warning to include stick shaker and signals to the pitch limit indicator and airspeed displays and the GPWS windshear detection and alert.

Two test switches are installed in the aft overhead panel. Pushing either of these initiates a self-test of the respective stall warning channel. The No. 1 activates the Captain stick shaker, and the No. 2 activates the F/O stick shaker. Either stick shaker vibrates both columns through column interconnects.

Altitude Alerting System

YA373 - YA377, YC202 - YC207, YE324 - YE326

Altitude alerting occurs when approaching or departing the MCP-selected altitude. Altitude alerting is inhibited when trailing edge flaps are extended to 25 or greater, or while G/S is captured.

Acquisition Alerting

900 feet before reaching the selected altitude, a white box shows around the selected altitude display and the box around the current altitude becomes bold. A momentary tone sounds. At 200 feet from selected altitude, the selected altitude box no longer shows.

Deviation Alerting

When deviating by 200 feet from the selected altitude, a momentary tone sounds and the current altitude box turns amber and begins to flash. The amber flashing continues until:

- altitude deviation becomes less than 200 feet
- altitude deviation becomes more than 900 feet
- a new altitude is selected.

Altitude Alert Profile

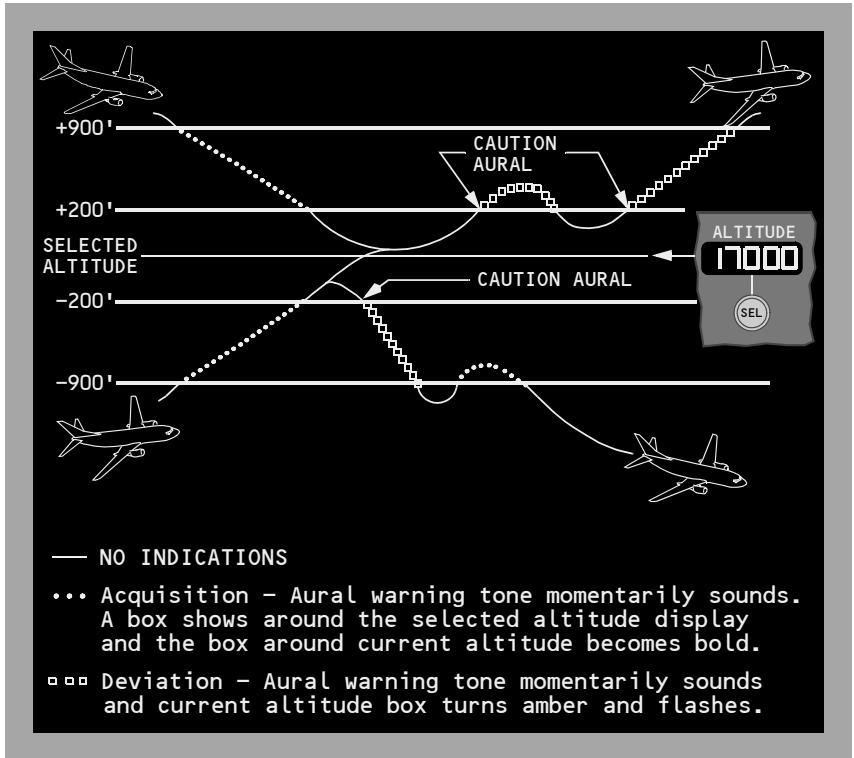

Altitude Alerting System

YA371, YA372, YC201

Altitude alerting occurs when approaching or departing the MCP-selected altitude. Altitude alerting is inhibited when trailing edge flaps are extended to 25 or greater, or while G/S is captured.

Acquisition Alerting

750 feet before reaching the selected altitude, both ALT ALERT annunciations show. At 200 feet from selected altitude, the ALT ALERT annunciations no longer show.

Deviation Alerting

When deviating by 200 feet from the selected altitude, a momentary tone sounds and the ALT ALERT annunciations flash. Flashing continues until:

- altitude deviation becomes less than 200 feet
- a new altitude is selected.

Altitude Alert Profile

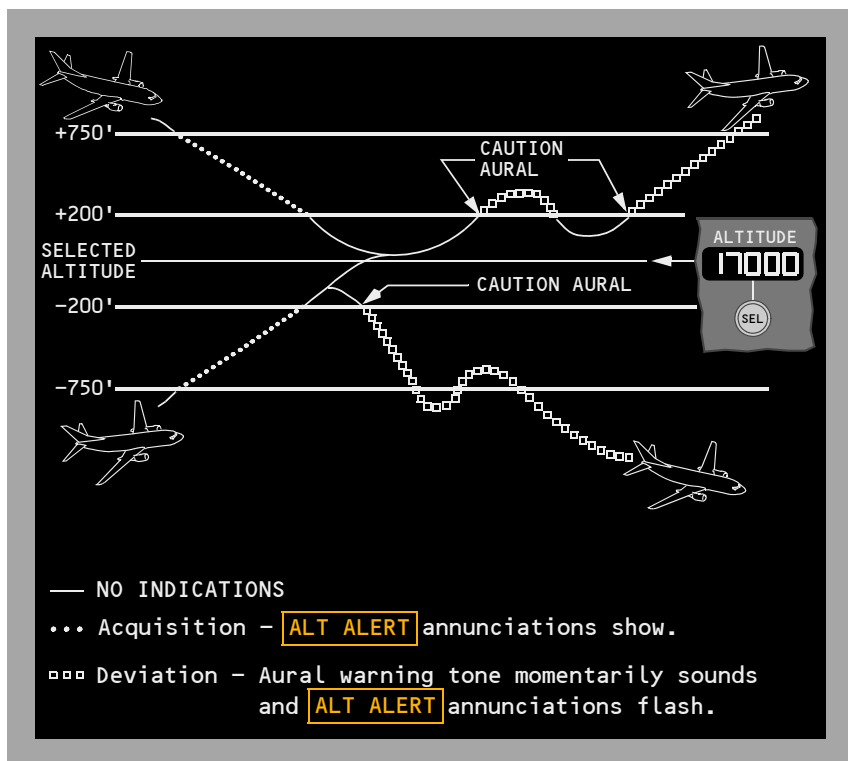

Altitude Alerting System

YE321 - YE323

Altitude alerting occurs when approaching or departing the MCP-selected altitude. Altitude alerting is inhibited when trailing edge flaps are extended to 25 or greater, or while G/S is captured.

Acquisition Alerting

750 feet before reaching the selected altitude, a white box appears around the selected altitude display and the box around the current altitude becomes bold. At 200 feet from selected altitude, the selected altitude box no longer shows.

Deviation Alerting

When deviating by 200 feet from the selected altitude, a momentary tone sounds and the current altitude box turns amber and begins to flash. The amber flashing continues until:

- altitude deviation becomes less than 200 feet
- a new altitude is selected.

Altitude Alert Profile

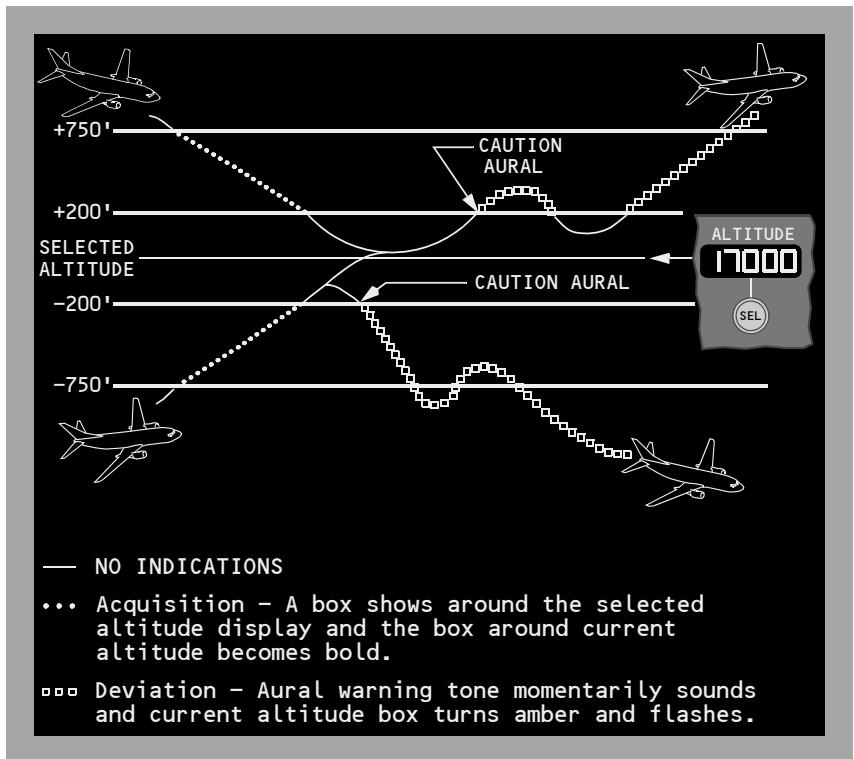

Ground Proximity Alerts

The GPWS provides alerts for potentially hazardous flight conditions involving imminent impact with the ground.

The GPWS monitors terrain proximity using an internal world wide terrain data base. Proximate terrain data shows on the navigation display. If there is a potential terrain conflict, alerts are provided based on estimated time to impact. These alerts are “look-ahead terrain alerts.”

The GPWS provides alerts based on radio altitude and combinations of barometric altitude, airspeed, glide slope deviation, and airplane configuration. The alerts are for:

- excessive descent rate
- excessive terrain closure rate
- altitude loss after takeoff or go-around
- unsafe terrain clearance when not in the landing configuration
- excessive deviation below an ILS glide slope

These alerts are “radio altitude based alerts.”

Ground proximity alerts are accompanied by voice aural alerts and the PULL UP annunciation on the attitude indicators or, for deviation below glide slope alert, the BELOW G/S light.

Note: Terrain ahead of the airplane may exceed available climb performance. A ground proximity alert does not guarantee terrain clearance.

Look-ahead terrain alerts and radio altitude based alerts are prioritized based on the level of hazard and the required flight crew reaction time. Look-ahead terrain alerts and radio altitude based alerts are inhibited by an actual windshear warning (airplane in windshear).

Look-Ahead Terrain Alerting

The GPWS terrain data base contains detailed terrain data near major airports, and data in lesser detail for areas between airports. Terrain within 2,000 feet of airplane barometric altitude shows on the navigation display. The terrain data is not designed to be an independent navigation aid.

Note: The GPWS terrain data base, look-ahead terrain alerting, and terrain display do not account for man made obstructions.

The terrain display is generated from a data base contained in the GPWS computer and correlated to GPS position.

Terrain and weather radar cannot show together on a display. If one pilot selects terrain and the other pilot selects weather radar, each display updates on alternating sweeps. All other displays (TCAS, LNAV routing, etc.) can show with terrain data.

Look-ahead terrain alerts are based on the airplane’s position, barometric altitude, vertical flight path, and ground speed.

737 Flight Crew Operations Manual
Look Ahead Terrain Alerts

AURAL ALERT	VISUAL ALERT	DESCRIPTION
TERRAIN TERRAIN PULL UP	PULL UP on both attitude indicators Red TERRAIN message on navigation display (all modes) Solid red terrain on navigation display	20 to 30 seconds from projected impact with terrain shown solid red on the navigation display (in expanded MAP, center MAP, expanded VOR, or expanded APP modes only). Moving the ground proximity terrain inhibit switch to TERRAIN INHIBIT inhibits the alert.
CAUTION TERRAIN	Amber TERRAIN message on navigation display (all modes) Solid amber terrain on navigation displays	40 to 60 seconds from projected impact with terrain shown solid amber on the navigation display (in expanded MAP, center MAP, expanded VOR, or expanded APP modes only). Moving the ground proximity terrain inhibit switch to TERRAIN INHIBIT inhibits the alert.
TOO LOW, TERRAIN	PULL UP on both attitude indicators	Descent below unsafe radio altitude while too far from any airport in the terrain database. Moving the ground proximity terrain inhibit switch to TERRAIN INHIBIT inhibits the alert.

Radio Altitude Based Alerts

AURAL ALERT	VISUAL ALERT	DESCRIPTION
PULL UP	PULL UP on both attitude indicators	Follows SINK RATE alert if descent rate becomes severe. Follows radio altitude based TERRAIN alert if excessive terrain closure rate continues and landing gear and/or flaps are not in landing configuration.
TERRAIN	PULL UP on both attitude indicators	Excessive terrain closure rate.
DON'T SINK	PULL UP on both attitude indicators	Excessive altitude loss after takeoff or go-around.

AURAL ALERT	VISUAL ALERT	DESCRIPTION
GLIDE SLOPE	BELOW G/S P-INHIBIT lights	Deviation below glide slope. Volume and repetition rate increase as deviation increases. Pushing the ground proximity BELOW G/S P-INHIBIT light cancels or inhibits the alert below 1,000 feet RA.
SINK RATE	PULL UP on both attitude indicators	Excessive descent rate.
TOO LOW, FLAPS	PULL UP on both attitude indicators	Unsafe terrain clearance at low airspeed with flaps not in a normal landing position. Pushing the ground proximity flap override switch to FLAP INHIBIT inhibits the alert.
TOO LOW, GEAR	PULL UP on both attitude indicators	Unsafe terrain clearance at low airspeed with landing gear not down. Pushing the ground proximity gear override switch to GEAR INHIBIT inhibits the alert.
TOO LOW, TERRAIN	PULL UP on both attitude indicators	Unsafe terrain clearance at high airspeed with either landing gear not down or flaps not in landing position. Follows DON'T SINK if another descent is initiated after initial alert, before climbing to the altitude where the initial descent began.

Windshear Alerts

Windshear alerts are available during takeoff, approach, and landing:

- The GPWS provides a warning when the airplane is in a windshear.
- The weather radar provides alerts for excessive windshear ahead of the airplane. These are “predictive windshear alerts.”

Windshear warnings are accompanied by WINDSHEAR on the attitude indicators and voice aural alerts.

Windshear cautions are accompanied by a voice aural alert.

Windshear alerts are prioritized based on the level of hazard and the required flight crew reaction time. Predictive windshear alerts are inhibited by an actual windshear warning (airplane in windshear), look-ahead terrain alerts, or radio altitude based alerts.

Windshear Warning (Airplane in Windshear)

AURAL ALERT	VISUAL ALERT	DESCRIPTION
Two-tone siren followed by WINDSHEAR	Red WINDSHEAR on both attitude indicators.	Excessive windshear at the current airplane position detected by GPWS. Enabled below 1,500 feet RA. GPWS Windshear detection begins at rotation.

Predictive Windshear Alerts

The weather radar uses radar imaging to detect disturbed air prior to entering a windshear.

Note: The weather radar provides windshear alerts for windshear events containing some level of moisture or particulate matter.

Note: The weather radar detects microbursts and other windshears with similar characteristics. The weather radar does not provide alerting for all types of windshear. The flight crew must continue to rely on traditional windshear avoidance methods.

AURAL ALERT	VISUAL ALERT	DESCRIPTION
WINDSHEAR AHEAD	Red WINDSHEAR on both attitude indicators RED windshear symbol on navigation display Red WINDSHEAR message on navigation display (all modes)	Windshear close to and directly ahead of the airplane detected by the weather radar. Enabled during takeoff, below 1,200 feet RA. Predictive windshear symbol on the navigation display shows windshear position (expanded MAP, center MAP, and expanded VOR or APP modes only).
GO AROUND, WINDSHEAR AHEAD	Red WINDSHEAR on both attitude indicators RED windshear symbol on navigation display Red WINDSHEAR message on navigation display (all modes)	Windshear within 1.5 miles and directly ahead of the airplane detected by the weather radar. Enabled during approach, below 1,200 feet RA. Predictive windshear symbol on the navigation display shows windshear position (expanded MAP, center MAP, and expanded VOR or APP modes only).
MONITOR RADAR DISPLAY	RED windshear symbol on navigation display Amber WINDSHEAR message on navigation display (all modes)	Windshear within 3 miles and ahead of the airplane detected by the weather radar. Enabled during takeoff and approach, below 1,200 feet RA. Predictive windshear symbol on the navigation display shows windshear position (expanded MAP, center MAP, and expanded VOR or APP modes only).

The weather radar automatically begins scanning for windshear when:

- thrust levers set for takeoff, or
- in flight below 2,300 feet RA (predictive windshear alerts are issued below 1,200 feet RA).

Alerts are available approximately 12 seconds after the weather radar begins scanning for windshear. Predictive windshear alerts can be enabled prior to takeoff by pushing the EFIS control panel WXR switch.

If windshear is not detected, weather radar returns show only after pushing the EFIS control panel WXR switch.

737 Flight Crew Operations Manual

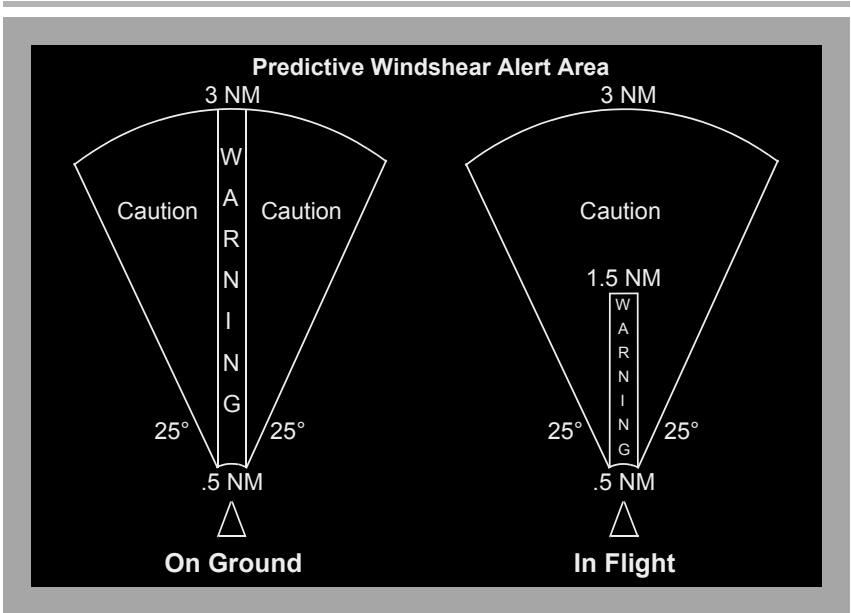

Predictive Windshear Inhibits

During takeoff and landing, new predictive windshear caution alerts are inhibited between 80 knots and 400 feet RA, and new warning alerts between 100 knots and 50 feet RA. These inhibits do not remove existing predictive windshear alerts.

Bank Angle Alert

The GPWS provides the aural alert BANK ANGLE, BANK ANGLE when roll angle exceeds 35 degrees, 40 degrees, and 45 degrees. Once sounded, the alert is silent for that bank angle (35, 40, or 45 degrees) until the system is reset by decreasing bank angle to 30 degrees or less.

Approach Callouts

Radio Altitude Callouts

YA371, YA372, YC201, YE321 - YE323

The GPWS provides the following altitude callouts during approach:

- 50 feet – FIFTY

Radio Altitude Callouts

YA373 - YA377, YC202 - YC207, YE324 - YE326

The GPWS provides the following altitude callouts during approach:

- 50 feet – FIFTY
- 40 feet – FORTY
- 30 feet – THIRTY
- 20 feet – TWENTY
- 10 feet – TEN.

500 Foot Radio Altitude Callout

When descending below 500 feet radio altitude on a non-precision approach, a FIVE HUNDRED callout is given if:

- the flight path is not within +/- 2 dots of a valid localizer beam, or
- the flight path is not within +/- 2 dots of a valid glideslope beam, or
- a backcourse approach is detected.

A valid localizer frequency must be tuned.

DH/MDA Callouts

YA371, YA372, YC201, YE321 - YE323

The GPWS provides height callouts based on the altitude set by the Captain's Minimums selector.

Callouts are based on radio altitude when the MINS selector is set to RADIO.

Callouts are based on barometric altitude when the MINS selector is set to BARO:

- DH/MDA plus 80 feet – APPROACHING MINIMUMS
- at DH/MDA – MINIMUMS

DH/MDA Callouts

YA373 - YA377, YC202 - YC207, YE324 - YE326

The GPWS provides height callouts based on the altitude set by the Captain's Minimums selector.

Callouts are based on radio altitude when the MINS selector is set to RADIO.

Callouts are based on barometric altitude when the MINS selector is set to BARO:

- DH/MDA plus 100 feet – PLUS HUNDRED
- at DH/MDA – MINIMUM

Traffic Alert and Collision Avoidance System (TCAS)

TCAS alerts the crew to possible conflicting traffic. TCAS interrogates operating transponders in other airplanes, tracks the other airplanes by analyzing the transponder replies, and predicts the flight paths and positions. TCAS provides advisory and traffic displays of the other airplanes to the flight crew. Neither advisory, guidance, nor traffic display is provided for other airplanes which do not have operating transponders. TCAS operation is independent of ground-based air traffic control.

To provide advisories, TCAS identifies a three dimensional airspace around the airplane where a high likelihood of traffic conflict exists. The dimensions of this airspace are based upon the closure rate with conflicting traffic.

TCAS equipment interrogates the transponders of other airplanes to determine their range, bearing, and altitude. A traffic advisory (TA) is generated when the other airplane is approximately 40 seconds from the point of closest approach. If the other airplane continues to close, a resolution advisory (RA) is generated when the other airplane is approximately 25 seconds from the point of closest approach. The RA provides aural warning and guidance as well as maneuver guidance to maintain or increase separation from the traffic.

Non-transponder equipped airplanes are invisible to TCAS. RAs can be generated if the other airplane has a mode C transponder. Coordinated RAs require both airplanes to have TCAS.

Advisories and Displays

Annunciations associated with TCAS and the traffic displays are discussed further in Chapter 10.

TAs are indicated by the aural “TRAFFIC, TRAFFIC” which sounds once and is then reset until the next TA occurs. The TRAFFIC annunciation appears on the navigation display. The TA symbol appears at the proper range and relative bearing of the other airplane. Altitude and vertical motion are included with the symbol if the other airplane is using transponder mode S or C.

RAs are indicated by one or more aural listed in the RA aural table. The TRAFFIC annunciation and RA symbol which depicts the traffic’s relative bearing, range, altitude, and vertical motion are on the navigation display similar to the TA symbol.

Additional symbols are proximate traffic and other traffic. Proximate traffic is within six miles and 1200 feet vertically, but is not expected to cause a TA or RA alert. Other traffic is beyond the six mile and 1200 feet vertical criteria. Traffic symbols are revised as the TCAS system constantly reevaluates the motion of other airplanes.

If the range of the navigation display does not permit the display of a TA or RA an OFFSCALE annunciation appears on the navigation display.

TA or RA traffic detected by TCAS which do not provide a bearing generate a no-bearing text block beneath the TRAFFIC text on the navigation display. The text block contains distance, altitude, and vertical motion information.

Vertical motion information is indicated by an arrow depicting a climb or descent if a change of greater than 500 feet per minute is detected.

TCAS display automatically shows when:

- the transponder mode selector is in TA ONLY or TA/RA, and
- a TCAS TA or RA occurs, and
- neither pilot has the TCAS (TFC) display selected, and
- in MAP, center MAP, VOR, or APP modes.

Inhibits

INCREASE DESCENT RAs are inhibited below approximately 1,500 feet radio altitude.

DESCEND RAs are inhibited below approximately 1,100 feet radio altitude.

RAs are inhibited below approximately 1,000 feet radio altitude. Below 1,000 feet when the TA/RA mode is selected on the transponder panel, TA only mode is enabled automatically and the TCAS message TA ONLY displays on the ND.

All TCAS voice annunciations are inhibited below approximately 500 feet radio altitude.

All TCAS alerts are inhibited by GPWS and windshear warnings.

Mode Control

The TCAS operating mode is controlled from the TCAS/ATC transponder panel. TCAS is normally operated in the TA/RA mode. However, sometimes it is necessary to operate in the TA ONLY mode to prevent undesired RAs. For example, TA ONLY may be selected when intentionally operating near other airplanes such as might be found in VFR conditions at a busy airport, or on parallel approach.

ATC transponders on TCAS equipped airplanes communicate to provide appropriate coordinated avoidance maneuvers. When performance is limited, such as with an inoperative engine, select TA ONLY to prevent receiving RAs beyond the airplane's capabilities, and to prevent communicating to other airplanes an ability to perform a RA maneuver.

Resolution Advisory Aural

The following table identifies the possible callouts associated with RAs and the vertical restrictions or maneuver recommended in each case.

AURAL ALERTS	VERTICAL RESTRICTIONS/MANEUVER
MONITOR VERTICAL SPEED	Present pitch attitude is outside the RA pitch command area. Keep pitch attitude away from red area.
MAINTAIN VERTICAL SPEED, MAINTAIN	
MAINTAIN VERTICAL SPEED, CROSSING MAINTAIN	
CLIMB, CLIMB	Climb at the displayed pitch
DESCEND, DESCEND	Descend at the displayed pitch
ADJUST VERTICAL SPEED, ADJUST	Reduce climb or descent rate
CLIMB, CROSSING CLIMB, CLIMB, CROSSING CLIMB	Climb at displayed pitch. Airplane climbs through traffic's altitude.
DESCEND, CROSSING DESCEND, DESCEND, CROSSING DESCEND	Descend at displayed pitch. Airplane descends through traffic's altitude.
INCREASE CLIMB, INCREASE CLIMB	Increase climb rate from initial pitch attitude.
INCREASE DESCENT, INCREASE DESCENT	Increase descent rate from initial pitch attitude.
CLIMB – CLIMB NOW, CLIMB – CLIMB NOW	Reversal maneuver from initial descent RA.
DESCEND – DESCEND NOW, DESCEND – DESCEND NOW	Reversal maneuver from initial climb RA.
CLEAR OF CONFLICT	RA encounter terminated. Maneuver guidance no longer displayed.

Tail Skid

YC201 - YC207

The tail skid assembly consists of a cartridge assembly, tail skid, fairing (skirt) and shoe. The fairing provides an enclosure for the actual tail skid structure. The shoe is fitted to the bottom of the fairing.

The cartridge assembly consists of a crushable honeycomb material. When the tail skid strikes the runway the skid moves upward and the honeycomb material crushes. The tail skid is serviceable when the cartridge warning decal shows both green and red. The green disappears gradually as the cartridge is crushed. When the warning decal is all red, the cartridge must be replaced.

The shoe is what contacts the runway in the event of an over rotation. The shoe surface displays “wear dimples” which serve as a reference for shoe replacement.

Tail Skid Detail

